

July 2013



SERVICE MANUAL ADDENDUM

IC-7000

CONTENTS

ADDITIONAL PAGES:

PARTS LIST	1
BOARD LAYOUTS	26
VOLTAGE DIAGRAM	30

PARTS LIST

[MAIN UNIT]

REF NO.	PARTS NO.	DESCRIPTION	M.	H/V LOCATION
IC1	1110004080	S.IC UPC2709T-E3	T	75.7/12.8
IC2	1110004101	S.IC TA4001F (TE85LF)	T	64.1/18.8
IC3	1110004091	S.IC TA4002F (TE85LF)	T	48.3/17.4
IC801	1110004080	S.IC UPC2709T-E3	T	86.0/57.5
	1130016260	S.IC BR24T64FVT-WE2	[EUR] [FRA]	
	1110004080	S.IC UPC2709T-E3	[ESP]	
	1110004080	S.IC UPC2709T-E3	[USA]	
	1110004080	S.IC UPC2709T-E3	[ITR]	
	1110004080	S.IC UPC2709T-E3	[UK]	
	1110004080	S.IC UPC2709T-E3	[KOR]	
	1110004080	S.IC UPC2709T-E3	[AUS]	
	1110004080	S.IC UPC2709T-E3	[CHN]	
IC1101	1110006730	S.IC NJM2594V-TE1-#ZZZB	T	5.0/83.4
IC1201	1130006221	S.IC TC4W53FU(TE12LF)	T	24.2/81.6
IC1202	1130006221	S.IC TC4W53FU(TE12LF)	T	19.8/81.4
IC1203	1110006570	S.IC TS462CPT	T	12.8/81.8
IC1301	1110005461	S.IC TA4107F(TE12LF)	T	13.7/63.4
IC1401	1110006541	S.IC LA1225M-TLM-E	B	23.4/82.2
IC1501	1110006530	S.IC TA4019F(TE12LF)	B	74.9/39.1
IC1502	1110005040	S.IC M52342FP 600C	B	79.7/57.0
IC1601	1110005320	S.IC NJM13403V-TE1-#ZZZB	T	8.6/41.5
IC1801	1180002020	S.REG BA033FP-E2	B	22.9/106.6
IC1901	1180001252	S.IC TA7808F(TE16L1NQ)	B	10.4/55.2
IC1951	1190002121	S.IC XC9201D09AKR-G	B	42.0/107.8
IC1952	1180002020	S.REG BA033FP-E2	B	14.7/125.9
IC2001	1180001252	S.IC TA7808F(TE16L1NQ)	B	8.5/19.1
IC2007	1110006570	S.IC TS462CPT	T	15.9/121.0
IC2101	1110005320	S.IC NJM13403V-TE1-#ZZZB	T	28.5/118.1
IC2102	1110005320	S.IC NJM13403V-TE1-#ZZZB	T	49.5/111.9
IC2103	1110005140	S.IC NJM3403AV-TE1-#ZZZB	T	49.5/121.2
IC2151	1130012720	S.IC CD74HC4094PWR	T	47.2/95.9
IC2152	1130012720	S.IC CD74HC4094PWR	T	37.9/95.9
IC2153	1130012720	S.IC CD74HC4094PWR	T	28.1/95.9
IC2154	1130012720	S.IC CD74HC4094PWR	T	28.2/101.5
IC2155	1110006680	S.IC BH2221FV-E2	T	38.2/118.1
IC2156	1130009100	S.IC BU4052BCFV-E2	T	10.2/107.7
IC2231	1110006640	S.IC NJM2244M-TE1-#ZZZB	T	34.8/109.4
IC2251	1130008511	S.IC TC7W53FU(TE12LF)	T	16.8/89.6
IC2501	1110006570	S.IC TS462CPT	B	12.8/91.8
IC2551	1110006570	S.IC TS462CPT	B	49.3/122.0
IC2601	1130006221	S.IC TC4W53FU(TE12LF)	B	63.2/124.0
IC2602	1110003091	IC LA4425A-E		
Q101	1530003091	S.TRA 2SC4213-B(TE85RF)	T	11.2/17.5
Q102	1590003940	S.TRA RN1105(TE85LF)	T	20.7/5.6
Q103	1590004030	S.TRA KRX204U-RTK/P	T	38.4/20.2
Q201	1590003940	S.TRA RN1105(TE85LF)	T	16.2/31.2
Q202	1590002310	S.TRA DTC114EE TL	T	23.6/28.5
Q204	1590003940	S.TRA RN1105(TE85LF)	B	44.8/38.7
Q205	1590003940	S.TRA RN1105(TE85LF)	T	43.0/61.5
Q206	1590003940	S.TRA RN1105(TE85LF)	B	24.6/55.0
Q207	1590003940	S.TRA RN1105(TE85LF)	B	24.6/51.9
Q208	1590003940	S.TRA RN1105(TE85LF)	B	24.2/48.8
Q209	1590003940	S.TRA RN1105(TE85LF)	B	23.6/45.7
Q210	1590003940	S.TRA RN1105(TE85LF)	B	43.0/41.5
Q211	1530003852	S.TRA 2SC551A-F-TD-E	T	27.6/30.2
Q301	1530003852	S.TRA 2SC551A-F-TD-E	T	56.7/32.5
Q402	1590004030	S.TRA KRX204U-RTK/P	T	82.9/22.8
Q403	1590004030	S.TRA KRX204U-RTK/P	T	69.7/23.6
Q502	1530003852	S.TRA 2SC551A-F-TD-E	T	83.1/37.1
Q701	1580000780	S.FET 3SK195(TE85LF)	T	36.1/196.6
Q702	1580000780	S.FET 3SK195(TE85LF)	T	54.7/51.9
Q901	1580000780	S.FET 3SK195(TE85LF)	T	36.6/65.7
Q902	1580000780	S.FET 3SK195(TE85LF)	T	35.9/73.2
Q1001	1580000780	S.FET 3SK195(TE85LF)	T	18.0/76.0
Q1001	1590004030	S.TRA KRX204U-RTK/P	T	28.1/78.7
Q1401	1530004140	S.TRA L2SC4081RT1G <SLVJ>	B	42.5/74.3
Q1402	1530004140	S.TRA L2SC4081RT1G <SLVJ>	B	36.7/80.1
Q1501	1590004030	S.TRA KRX204U-RTK/P	T	30.6/78.5
Q1521	1530004140	S.TRA L2SC4081RT1G <SLVJ>	B	86.0/47.6
Q1601	1530003091	S.TRA 2SC4213-B(TE85RF)	T	8.3/53.0
Q1602	1590001870	S.TRA DTA114EE TL	T	4.6/53.0
Q1603	1590003940	S.TRA RN1105(TE85LF)	T	2.8/40.8
Q1604	1510000771	S.TRA 2SA1586-GR(TE85LF)	T	5.1/32.7
Q1606	1560001260	S.FET 2SK3018 T106	T	12.6/36.9
Q1701	1530004210	S.TRA DSC7004SOL	B	52.4/48.3
Q1702	1590003940	S.TRA RN1105(TE85LF)	B	54.4/52.2
Q1703	1530004210	S.TRA DSC7004SOL	B	52.4/67.4
Q1704	1590003940	S.TRA RN1105(TE85LF)	B	54.1/72.9
Q1901	1590004030	S.TRA KRX204U-RTK/P	T	35.8/78.5
Q1902	1590004030	S.TRA KRX204U-RTK/P	T	33.3/78.5
Q1903	1590004030	S.TRA KRX204U-RTK/P	B	23.7/17.0
Q1904	1590004030	S.TRA KRX204U-RTK/P	B	33.0/88.0
Q1905	1590004030	S.TRA KRX204U-RTK/P	B	46.0/41.0
Q1906	1590004030	S.TRA KRX204U-RTK/P	B	26.3/30.9
Q1907	1590004030	S.TRA KRX204U-RTK/P	T	41.0/78.5
Q1908	1590004030	S.TRA KRX204U-RTK/P	T	38.4/78.5
Q1909	1590004030	S.TRA KRX204U-RTK/P	B	22.1/11.9
Q1960	1550000090	S.FET RSQ035P03TR	B	38.0/103.7
Q2150	1590004030	S.TRA KRX204U-RTK/P	T	48.5/100.1
Q2151	1520000460	S.TRA 2SB1132 T100 R	T	55.4/103.8
Q2152	1520000460	S.TRA 2SB1132 T100 R	T	21.4/111.1
Q2153	1520000460	S.TRA 2SB1132 T100 R	T	49.8/104.6
Q2154	1590004030	S.TRA KRX204U-RTK/P	T	44.7/100.1
Q2155	1590004030	S.TRA KRX204U-RTK/P	T	40.0/100.1
Q2156	1590003940	S.TRA RN1105(TE85LF)	T	58.9/104.5
Q2157	1590003940	S.TRA RN1105(TE85LF)	T	25.5/107.9

[MAIN UNIT]

REF NO.	PARTS NO.	DESCRIPTION	M.	H/V LOCATION
Q2158	1590003940	S.TRA RN1105(TE85LF)	T	45.6/107.1
Q2159	1590004030	S.TRA KRX204U-RTK/P	T	6.7/118.2
Q2160	1590004030	S.TRA KRX204U-RTK/P	T	7.7/122.2
Q2231	1590003940	S.TRA RN1105(TE85LF)	T	4.7/121.7
Q2232	1590004030	S.TRA KRX204U-RTK/P	T	57.4/114.8
Q2233	1590004030	S.TRA KRX204U-RTK/P	T	54.7/115.8
Q2301	1530004140	S.TRA L2SC4081RT1G <SLVJ>	T	30.6/109.1
Q2401	1530004210	S.TRA DSC7004SOL	B	80.2/26.4
Q2601	1560001260	S.FET 2SK3018 T106	B	36.2/124.7
Q2602	1550000360	S.FET RQ1E050RPTTR	B	37.4/127.6
Q2603	1530004140	S.TRA L2SC4081RT1G <SLVJ>	T	65.4/111.4
Q2605	1590003940	S.TRA RN1105(TE85LF)	T	11.7/112.7
Q2606	1540000451	S.TRA 2SD1623T-TD-E	B	89.5/120.0
Q2607	1590003940	S.TRA RN1105(TE85LF)	B	65.5/120.5
Q2608	1590003940	S.TRA RN1105(TE85LF)	B	45.0/128.7
D1	1750000581	S.DIO 1SV307(TPH3F)	T	70.2/16.6
D2	1750000581	S.DIO 1SV307(TPH3F)	T	70.4/14.9
D3	1750000581	S.DIO 1SV307(TPH3F)	T	45.3/19.8
D4	1750000581	S.DIO 1SV307(TPH3F)	T	41.9/19.1
D5	1750000581	S.DIO 1SV307(TPH3F)	T	70.4/18.4
D6	1790000620	S.DIO MA77(TX)	B	79.9/17.1
D7	1790000620	S.DIO MA77(TX)	T	78.1/15.9
D8	1790000620	S.DIO MA77(TX)	B	81.6/10.6
D9	1790000620	S.DIO MA77(TX)	T	79.1/11.5
D10	1750000581	S.DIO 1SV307(TPH3F)	T	42.5/20.9
D101	1750000581	S.DIO 1SV307(TPH3F)	T	13.3/22.5
D102	1750000581	S.DIO 1SV307(TPH3F)	T	15.7/19.2
D103	1750000581	S.DIO 1SV307(TPH3F)	T	20.4/8.8
D104	1750000581	S.DIO 1SV307(TPH3F)	T	34.8/18.0
D105	1750000581	S.DIO 1SV307(TPH3F)	T	23.2/12.7
D106	1750000581	S.DIO 1SV307(TPH3F)	T	29.7/21.0
D107	1750000581	S.DIO 1SV307(TPH3F)	T	44.0/23.7
D108	1750000951	S.DIO MA2J7320GL	B	27.2/18.3
D109	1750000951	S.DIO MA2J7320GL	B	24.8/20.3
D110	1790001241	S.DIO MA2S7280GL	B	51.6/26.5
D111	1790001241	S.DIO MA2S7280GL	B	51.6/24.7
D112	1750000581	S.DIO 1SV307(TPH3F)	T	15.7/21.0
D113	1750000581	S.DIO 1SV307(TPH3F)	T	10.3/19.8
D114	1790001251	S.DIO MA2S1110GL	T	35.7/21.4
D203	1750000581	S.DIO 1SV307(TPH3F)	T	19.4/35.7
D204	1750000581	S.DIO 1SV307(TPH3F)	T	25.7/58.3
D205	1750000581	S.DIO 1SV307(TPH3F)	T	25.7/56.3
D208	1750000581	S.DIO 1SV307(TPH3F)	T	25.7/53.4
D209	1750000581	S.DIO 1SV307(TPH3F)	T	25.7/50.6
D210	1750000581	S.DIO 1SV307(TPH3F)	T	25.7/47.7
D211	1750000581	S.DIO 1SV307(TPH3F)	T	25.7/44.8
D212	1750000581	S.DIO 1SV307(TPH3F)	T	25.7/39.2
D213	1750000581	S.DIO 1SV307(TPH3F)	T	25.7/41.5
D214	1750000581	S.DIO 1SV307(TPH3F)	T	47.7/59.3
D215	1750000581	S.DIO 1SV307(TPH3F)	T	47.7/56.3
D216	1750000581	S.DIO 1SV307(TPH3F)	T	48.0/53.7
D217	1750000581	S.DIO 1SV307(TPH3F)	T	47.8/49.7
D218	1750000581	S.DIO 1SV307(TPH3F)	B	41.8/47.3
D219	1750000581	S.DIO 1SV307(TPH3F)	B	38.9/41.7
D220	1750000581	S.DIO 1SV307(TPH3F)	B	44.7/28.6
D221	1750000581	S.DIO 1SV307(TPH3F)	B	40.5/36.1
D301	1750000581	S.DIO 1SV307(TPH3F)	T	47.3/28.5
D302	1750000581	S.DIO 1SV307(TPH3F)	T	49.5/30.3
D303	1750000581	S.DIO 1SV307(TPH3F)	T	64.1/30.0
D304	1750000581	S.DIO 1SV307(TPH3F)	T	62.4/35.2
D305	1750000581	S.DIO 1SV307(TPH3F)	T	73.4/35.2
D306	1750000581	S.DIO 1SV307(TPH3F)	T	64.5/25.7
D401	1790001241	S.DIO MA2S7280GL	T	86.7/24.9
D501	1750000531	S.DIO 1SV271(TPH3F)	T	90.6/32.3
D502	1750000581	S.DIO 1SV307(TPH3F)	T	86.2/31.5
D503	1750000581	S.DIO 1SV307(TPH3F)	T	89.4/29.8
D504	1750000531	S.DIO 1SV271(TPH3F)	T	89.8/37.8
D505	1750000581	S.DIO 1SV307(TPH3F)	T	86.7/40.1
D506	1750000581	S.DIO 1SV307(TPH3F)	B	87.3/35.6
D601	1750000581	S.DIO 1SV307(TPH3F)	B	90.0/38.6
D602	1750000581	S.DIO 1SV307(TPH3F)	T	92.5/41.5
D603	1750000581	S.DIO 1SV307(TPH3F)	B	76.2/46.6
D604	1750000581	S.DIO 1SV307(TPH3F)	T	66.7/43.7
D701	1750000581	S.DIO 1SV307(TPH3F)	T	61.2/43.8
D702	1750000581	S.DIO 1SV307(TPH3F)	T	65.1/41.4
D703	1750000581	S.DIO 1SV307(TPH3F)	T	62.7/61.5
D704	1750000581	S.DIO 1SV307(TPH3F)	T	62.7/63.2
D801	1750000431	S.DIO HSB88WSTR-E	T	74.1/60.3
D802	1750000581	S.DIO 1SV307(TPH3F)	T	63.1/73.4
D803	1750000581	S.DIO 1SV307(TPH3F)	T	65.5/64.6
D903	1750000581	S.DIO 1SV307(TPH3F)	T	39.5/69.4
D904	1750000581	S.DIO 1SV307(TPH3F)	T	39.5/72.8
D1301	1750000581	S.DIO 1SV307(TPH3F)	T	12.8/72.6
D1302	1750000581	S.DIO 1SV307(TPH3F)	T	13.9/70.9
D1521	1750000531	S.DIO 1SV271(TPH3F)	B	79.5/40.7
D1522	1750000531	S.DIO 1SV271(TPH3F)	B	79.5/42.5
D1601	1790001241	S.DIO MA2S7280GL	T	15.2/48.8
D1602	1790001241	S.DIO MA2S7280GL	T	18.3/53.2
D1604	1790001251	S.DIO MA2S1110GL	T	7.7/31.5
D1605	1790001251	S.DIO MA2S1110GL	T	7.7/32.8
D1606	1790001251	S.DIO MA2S1110GL	T	14.2/44.9
D1607	1790001251	S.DIO MA		

[MAIN UNIT]

REF NO.	PARTS NO.	DESCRIPTION	M.	H/V LOCATION
D1702	1790001670	S.DIO RB706F-40T106	B	51.9/71.8
D1951	1750001110	S.DIO SM240A-T <SEI>	B	36.3/100.0
D2151	1790001251	S.DIO MA2S1110GL [USA]	T	39.0/87.1
	1790001251	S.DIO MA2S1110GL [KOR]		
	1790001251	S.DIO MA2S1110GL [AUS]		
D2153	1790001251	S.DIO MA2S1110GL [USA]	T	36.5/87.1
	1790001251	S.DIO MA2S1110GL [KOR]		
D2154	1790001251	S.DIO MA2S1110GL	T	36.5/88.4
D2155	1790001251	S.DIO MA2S1110GL	T	36.6/89.7
D2156	1790001251	S.DIO MA2S1110GL	T	39.0/90.6
D2157	1790001251	S.DIO MA2S1110GL [EUR]	T	48.6/87.1
	1790001251	S.DIO MA2S1110GL [ESP]		
	1790001251	S.DIO MA2S1110GL [USA]		
	1790001251	S.DIO MA2S1110GL [ITR]		
	1790001251	S.DIO MA2S1110GL [UK]		
	1790001251	S.DIO MA2S1110GL [KOR]		
	1790001251	S.DIO MA2S1110GL [AUS]		
	1790001251	S.DIO MA2S1110GL [CHN]		
D2158	1790001251	S.DIO MA2S1110GL	T	48.6/88.4
D2159	1790001251	S.DIO MA2S1110GL	T	48.6/89.7
D2160	1790001251	S.DIO MA2S1110GL	T	48.6/91.0
D2162	1790001251	S.DIO MA2S1110GL [USA] only	T	46.1/88.4
D2163	1790001251	S.DIO MA2S1110GL [EUR]	T	46.1/89.7
	1790001251	S.DIO MA2S1110GL [FRA]		
	1790001251	S.DIO MA2S1110GL [ESP]		
	1790001251	S.DIO MA2S1110GL [ITR]		
	1790001251	S.DIO MA2S1110GL [UK]		
D2166	1790001251	S.DIO MA2S1110GL [ESP]	T	29.4/88.3
	1790001251	S.DIO MA2S1110GL [KOR]		
D2168	1790001251	S.DIO MA2S1110GL [EUR]	T	29.4/90.7
	1790001251	S.DIO MA2S1110GL [ESP]		
	1790001251	S.DIO MA2S1110GL [ITR]		
	1790001251	S.DIO MA2S1110GL [UK]		
	1790001251	S.DIO MA2S1110GL [AUS]		
D2169	1790001251	S.DIO MA2S1110GL [EUR]	T	26.9/87.1
	1790001251	S.DIO MA2S1110GL [ESP]		
	1790001251	S.DIO MA2S1110GL [USA]		
	1790001251	S.DIO MA2S1110GL [ITR]		
	1790001251	S.DIO MA2S1110GL [UK]		
	1790001251	S.DIO MA2S1110GL [KOR]		
	1790001251	S.DIO MA2S1110GL [CHN]		
D2170	1790001251	S.DIO MA2S1110GL [EUR]	T	26.9/88.4
	1790001251	S.DIO MA2S1110GL [USA]		
	1790001251	S.DIO MA2S1110GL [ITR]		
	1790001251	S.DIO MA2S1110GL [UK]		
	1790001251	S.DIO MA2S1110GL [AUS]		
	1790001251	S.DIO MA2S1110GL [CHN]		
D2171	1790001251	S.DIO MA2S1110GL [FRA]	T	26.9/89.7
	1790001251	S.DIO MA2S1110GL [ESP]		
	1790001251	S.DIO MA2S1110GL [UK]		
	1790001251	S.DIO MA2S1110GL [KOR]		
	1790001251	S.DIO MA2S1110GL [CHN]		
D2172	1790001251	S.DIO MA2S1110GL [EUR]	T	26.9/91.0
	1790001251	S.DIO MA2S1110GL [FRA]		
	1790001251	S.DIO MA2S1110GL [ESP]		
	1790001251	S.DIO MA2S1110GL [ITR]		
	1790001251	S.DIO MA2S1110GL [UK]		
	1790001251	S.DIO MA2S1110GL [KOR]		
	1790001251	S.DIO MA2S1110GL [AUS]		
D2173	1790001251	S.DIO MA2S1110GL	T	6.5/120.2
D2174	1790001251	S.DIO MA2S1110GL [EUR]	T	52.1/88.3
	1790001251	S.DIO MA2S1110GL [FRA]		
	1790001251	S.DIO MA2S1110GL [ESP]		
	1790001251	S.DIO MA2S1110GL [USA]		
	1790001251	S.DIO MA2S1110GL [UK]		
	1790001251	S.DIO MA2S1110GL [KOR]		
	1790001251	S.DIO MA2S1110GL [AUS]		
	1790001251	S.DIO MA2S1110GL [CHN]		
D2175	1790001251	S.DIO MA2S1110GL	T	52.1/87.1
D2201	1730002341	S.ZEN MAZ8047GML	T	10.5/122.8
D2205	1790001011	S.ZEN MAZ8043GLL	T	13.5/115.2
D2211	1790001011	S.ZEN MAZ8043GLL	T	21.5/118.0
D2231	1160000070	S.DIO DAN202K T146	T	57.7/117.9
D2232	1790001670	S.DIO RB706F-40T106	T	56.9/112.2
D2401	1160000070	S.DIO DAN202K T146	B	85.8/27.2
D2402	1790001251	S.DIO MA2S1110GL	T	63.6/113.3
D2551	1790001141	S.ZEN MAZ8039GLL	B	45.4/116.5
D2601	1160000070	S.DIO DAN202K T146	B	42.1/126.4
D2602	1790001251	S.DIO MA2S1110GL	B	41.3/128.5
FI2	2040001420	S.LC LFB32440MSC1-955 (LFSC25N12B0)	T	59.4/13.9
FI3	2040001420	S.LC LFB32440MSC1-955 (LFSC25N12B0)	T	53.4/13.5
FI601	2010002640	S.XTA DSF753SDF 124.487 MHz (FL-374)	T	81.0/43.8
FI901	2020002011	S.CER CFUKG455KF4A-R0	T	44.8/69.7
FI1001	2020002011	S.CER CFUKG455KF4A-R0	T	27.8/67.0
FI1401	2020001810	S.CER SFECV10M7FA00-R0 (SFECV10.7MA5S)	B	37.5/76.5
FI1402	2020001810	S.CER SFECV10M7FA00-R0 (SFECV10.7MA5S)	B	29.5/77.5
FI1501	2040002050	SAW K3561M [EUR]		
	2040002050	SAW K3561M [FRA]		
	2040002050	SAW K3561M [ESP]		
	2040002040	SAW M3565M [USA]		
	2040002050	SAW K3561M [ITR]		
	2040002050	SAW K3561M [UK]		
	2040002040	SAW M3565M [KOR]		
	2040002050	SAW K3561M [AUS]		
	2040002050	SAW K3561M [CHN]		

Eqv.= This component is equivalent to the REF No. component listed above, and may be substituted on parts orders and repairs.

[MAIN UNIT]

REF NO.	PARTS NO.	DESCRIPTION	M.	H/V LOCATION
FI1502	2020001720	S.CER SFSKA5M50CF00-R1 (SFSCC5.5MC2-T) [EUR]	B	69.4/57.8
	2020001720	S.CER SFSKA5M50CF00-R1 (SFSCC5.5MC2-T) [FRA]		
	2020001720	S.CER SFSKA5M50CF00-R1 (SFSCC5.5MC2-T) [ESP]		
	2020001700	S.CER SFSKA4M50CF00-R1 (SFSCC4.5MC2-T) [USA]		
	2020001720	S.CER SFSKA5M50CF00-R1 (SFSCC5.5MC2-T) [ITR]		
	2020001720	S.CER SFSKA5M50CF00-R1 (SFSCC5.5MC2-T) [UK]		
	2020001700	S.CER SFSKA4M50CF00-R1 (SFSCC4.5MC2-T) [KOR]		
	2020001720	S.CER SFSKA5M50CF00-R1 (SFSCC5.5MC2-T) [AUS]		
	2020001720	S.CER SFSKA5M50CF00-R1 (SFSCC5.5MC2-T) [CHN]		
FI1503	2020001730	S.CER TPSKA5M50B00-R1 (TPSCC5.5MB-TC1) [EUR]	B	73.6/78.7
	2020001730	S.CER TPSKA5M50B00-R1 (TPSCC5.5MB-TC1) [FRA]		
	2020001730	S.CER TPSKA5M50B00-R1 (TPSCC5.5MB-TC1) [ESP]		
	2020001710	S.CER TPSKA4M50B00-R1 (TPSCC4.5M0-TC1) [USA]		
	2020001730	S.CER TPSKA5M50B00-R1 (TPSCC5.5MB-TC1) [ITR]		
	2020001730	S.CER TPSKA5M50B00-R1 (TPSCC5.5MB-TC1) [UK]		
	2020001710	S.CER TPSKA4M50B00-R1 (TPSCC4.5M0-TC1) [KOR]		
	2020001730	S.CER TPSKA5M50B00-R1 (TPSCC5.5MB-TC1) [AUS]		
	2020001730	S.CER TPSKA5M50B00-R1 (TPSCC5.5MB-TC1) [CHN]		
L3	6200004480	S.COI MLF1608D R82K-T	T	76.5/10.2
L4	6200002041	S.COI NLV25T-101J	T	75.7/18.9
L5	6200004780	S.COI MLF1608A 1R5K-T	T	67.4/18.6
L8	6200010910	S.COI LQW18AN56NG00D	T	57.0/16.7
L10	6200010910	S.COI LQW18AN56NG00D	T	57.3/18.0
L11	6200011780	S.COI LQW18ANR18G00D	T	56.5/20.1
L12	6200011680	S.COI LQW18ANR12G00D	T	53.8/19.9
L13	6200011780	S.COI LQW18ANR18G00D	T	52.8/18.6
L14	6200009590	S.COI MLG1608B 18NJ-T	T	57.3/11.4
L16	6200005721	S.COI ELJRE 33NGFA	T	49.6/19.8
L18	6200005041	S.COI NLV25T-220J	T	73.4/9.6
L19	6200002041	S.COI NLV25T-101J	T	67.0/14.8
L21	6200006671	S.COI ELJRE 68NGFA	B	80.4/14.7
L22	6200002861	S.COI NLV25T-4R7J	B	79.8/20.3
L23	6200002861	S.COI NLV25T-4R7J	B	84.0/9.3
L24	6200011520	S.COI SLF7045T-102MR14-PF	B	8.9/69.0
L101	6200002041	S.COI NLV25T-101J	T	15.8/17.1
L102	6200002041	S.COI NLV25T-101J	T	20.4/10.9
L103	6200010800	S.COI C2520C-4R7G-A	T	24.4/7.4
L104	6200010800	S.COI C2520C-4R7G-A	T	27.9/10.0
L105	6200002041	S.COI NLV25T-101J	T	28.1/12.9
L106	6200002041	S.COI NLV25T-101J	B	17.6/16.4
L107	6200002041	S.COI NLV25T-101J	B	31.6/21.7
L108	6200002041	S.COI NLV25T-101J	T	25.3/20.9
L109	6200001831	S.COI NLV32T-100J	T	28.5/15.6
L110	6200003121	S.COI NLV32T-8R2J	T	21.1/15.1
L112	6200002041	S.COI NLV25T-101J	B	43.5/23.1
L113	6200002041	S.COI NLV25T-101J	T	7.2/17.6
L114	6200002041	S.COI NLV25T-101J	T	7.2/15.0
L116	6200003131	S.COI NLV32T-120J	T	28.5/18.6
L117	6200001831	S.COI NLV32T-100J	T	21.1/18.1
L204	6200002041	S.COI NLV25T-101J	T	18.8/33.0
L205	6200010740	S.COI C2520C-R27G-A	T	20.3/38.2
L207	62000010680	S.COI C2520C-R22G-A (0.22U)	T	21.8/41.3
L213	6200005011	S.COI NLV25T-100J	T	22.7/34.9
L215	6200010330	S.COI C2012C-R18G-A	B	27.8/38.6
L217	6200009990	S.COI C2012C-R22G-A	T	22.7/32.5
L218	6200005011	S.COI NLV25T-100J	B	25.7/43.4
L219	6200011050	S.COI C2012C-R12G-A	B	29.0/41.4
L220	6200010320	S.COI C2012C-R15G-A	B	34.1/37.9
L221	6200002041	S.COI NLV25T-101J	T	15.1/52.7
L222	6200002041	S.COI NLV25T-101J	T	45.6/61.5
L223	6200002041	S.COI NLV25T-101J	B	40.5/55.3
L224	6200002041	S.COI NLV25T-101J	B	27.5/55.8
L225	6200002041	S.COI NLV25T-101J	B	27.5/52.0
L226	6200002861	S.COI NLV25T-4R7J	T	40.3/57.6
L227	6200003711	S.COI NLV25T-2R7J	T	29.1/55.5
L228	6200002861	S.COI NLV25T-4R7J	T	44.6/54.7
L229	6200004671	S.COI NLV25T-3R9J	T	35.1/51.5
L230	6200002041	S.COI NLV25T-101J	B	40.5/52.3
L231	6200002041	S.COI NLV25T-101J	B	40.5/49.5
L232	6200002041	S.COI NLV25T-101J	B	27.1/49.1
L233	6200002041	S.COI NLV25T-101J	B	26.4/46.2
L234	6200010780	S.COI C2520C-1R0G-A	T	35.6/48.5
L235	6200010530	S.COI C2520C-R56G-A (0.56U)	B	33.0/49.5
L236	6200010950	S.COI C2520C-1R5G-A (1.5U)	T	43.4/50.4
L237	6200010450	S.COI C2520C-R82G-A (0.82U)	B	33.0/46.4
L238	6200002041	S.COI NLV25T-101J	B	44.0/45.1
L239	6200002041	S.COI NLV25T-101J	B	38.8/39.5
L240	6200002041	S.COI NLV25T-101J	T	29.5/42.1
L241	6200010870	S.COI C2520C-R33G-A (0.33U)	B	35.2/41.6
L242	6200005011	S.COI NLV25T-100J	T	33.5/29.9
L243	6140004601	S.COI LR-518A	T	28.4/35.2
L244	6200010960	S.COI C2520C-R47G-A (0.47U)	B	39.8/44.2
L245	6200005011	S.COI NLV25T-100J		

[MAIN UNIT]

REF NO.	PARTS NO.	DESCRIPTION	M.	H/V LOCATION
L248	6200005011	S.COI NLV25T-100J	B	43.8/36.4
L301	6200002041	S.COI NLV25T-101J	T	36.1/27.4
L302	6200002041	S.COI NLV25T-101J	T	52.6/31.8
L303	6200002041	S.COI NLV25T-101J	T	52.3/35.4
L304	6140004591	S.COI LR-517A	T	56.4/39.0
L305	6200002041	S.COI NLV25T-101J	T	52.9/29.3
L306	6200002041	S.COI NLV25T-101J	T	61.8/39.4
L307	6200002041	S.COI NLV25T-101J	T	60.9/32.0
L308	6200002041	S.COI NLV25T-101J	T	65.0/33.1
L309	6200009070	S.COI LQW18AN18NG00D (LQW1608A18NG00)	T	49.3/24.0
L310	6200010650	S.COI C2520C-R12G-A (0.12U)	T	65.7/38.2
L311	6200009220	S.COI LQW18AN15NG00D (LQW1608A15NG00)	T	53.6/23.3
L312	6200010660	S.COI C2520C-R15G-A (0.15U)	T	69.6/34.3
L313	6200011730	S.COI LQW18AN10NG00D	T	61.6/25.7
L314	6200002041	S.COI NLV25T-101J	T	72.6/37.4
L315	6200002041	S.COI NLV25T-101J	T	75.9/31.9
L402	6140004610	S.COI LR-520	T	70.8/27.9
L403	6200002041	S.COI NLV25T-101J	T	81.1/19.8
L404	6130002961	S.COI #617DB-1327=P3	T	84.4/27.9
L406	6130002961	S.COI #617DB-1327=P3	T	77.7/24.2
L421	6200004590	S.COI MLF1608D R18K-T	T	86.4/21.7
L501	6200004660	S.COI MLF1608A 1R8K-T	T	93.4/35.8
L503	6200004660	S.COI MLF1608A 1R8K-T	T	83.3/31.2
L507	6200001981	S.COI NLV25T-1R0J	T	78.8/34.4
L508	6200010650	S.COI C2520C-R12G-A (0.12U)	T	86.4/34.4
L509	6200004660	S.COI MLF1608A 1R8K-T	T	93.2/38.8
L511	6200004150	S.COI MLF1608D 47NM-T	T	92.7/37.3
L512	6200009610	S.COI MLG1608B 39NJ-T	B	89.7/32.9
L601	6200004660	S.COI MLF1608A 1R8K-T	B	85.7/38.6
L603	6200004660	S.COI MLF1608A 1R8K-T	T	89.4/42.2
L604	6150005330	S.COI LS-548 PKI-4185	T	90.5/46.2
L605	6200004660	S.COI MLF1608A 1R8K-T	T	93.2/40.0
L607	6200011800	S.COI C2520C-47NG-A	B	85.5/43.6
L609	6200011800	S.COI C2520C-47NG-A	B	81.9/46.9
L610	6200004660	S.COI MLF1608A 1R8K-T	B	78.2/44.9
L611	6200004660	S.COI MLF1608A 1R8K-T	T	68.0/46.3
L612	6150005330	S.COI LS-548 PKI-4185	T	72.3/42.4
L701	6150005350	S.COI LS-550 PKI-4187	T	62.9/48.6
L702	6150005340	S.COI LS-549 PKI-4186	T	54.8/45.5
L703	6150005350	S.COI LS-550 PKI-4187	T	55.3/59.5
L704	6200004940	S.COI MLF1608D R27K-T	T	62.3/59.7
L705	6200009920	S.COI C2012C-R10G-A	T	61.8/41.7
L801	6140002810	S.COI LR-317	T	68.6/61.3
L802	6200005190	S.COI MLF1608D R56K-T	T	89.1/58.5
L803	6140002810	S.COI LR-317	T	79.6/60.2
L804	6200005011	S.COI NLV25T-100J	T	57.5/69.1
L805	6200009871	S.COI NLV25T-120J	T	57.6/71.9
L806	6200004741	S.COI NLV25T-1R2J	T	63.1/71.2
L807	6200004741	S.COI NLV25T-1R2J	T	63.2/66.7
L808	6200004100	S.COI MLF1608D 68NM-T	T	86.2/61.7
L901	6200003520	S.COI ELJFB 102K-F	B	37.6/72.5
L904	6150005360	S.COI LS-551 PKI-4188-1	T	51.7/70.9
L905	6200003520	S.COI ELJFB 102K-F	B	40.2/59.9
L906	6200003520	S.COI ELJFB 102K-F	B	33.7/62.5
L908	6200003520	S.COI ELJFB 102K-F	B	31.5/69.8
L1003	6200003520	S.COI ELJFB 102K-F	B	13.0/75.3
L1102	6200002041	S.COI NLV25T-101J	T	7.1/89.7
L1301	6200002041	S.COI NLV25T-101J	T	8.3/55.8
L1302	6200002041	S.COI NLV25T-101J	T	11.8/58.6
L1303	6200002041	S.COI NLV25T-101J	T	4.8/55.8
L1401	6200002041	S.COI NLV25T-101J	B	43.4/79.7
L1402	6200004790	S.COI MLF1608D R47K-T	B	44.1/70.4
L1403	6200002041	S.COI NLV25T-101J	B	17.7/85.0
L1404	6200003711	S.COI NLV25T-2R7J	B	18.3/80.4
L1405	6200002041	S.COI NLV25T-101J	B	17.7/85.0
L1491	6200010870	S.COI C2520C-R33G-A (0.33U) [EUR]	B	85.0/30.7
	6200010870	S.COI C2520C-R33G-A (0.33U) [FRA]		
	6200010870	S.COI C2520C-R33G-A (0.33U) [ESP]		
	6200010740	S.COI C2520C-R27G-A [USA]		
	6200010870	S.COI C2520C-R33G-A (0.33U) [ITR]		
	6200010870	S.COI C2520C-R33G-A (0.33U) [UK]		
	6200010740	S.COI C2520C-R27G-A [KOR]		
	6200010870	S.COI C2520C-R33G-A (0.33U) [AUS]		
	6200010870	S.COI C2520C-R33G-A (0.33U) [CHN]		
L1492	6200010870	S.COI C2520C-R33G-A (0.33U) [EUR]	B	80.6/33.1
	6200010870	S.COI C2520C-R33G-A (0.33U) [FRA]		
	6200010870	S.COI C2520C-R33G-A (0.33U) [ESP]		
	6200010740	S.COI C2520C-R27G-A [USA]		
	6200010870	S.COI C2520C-R33G-A (0.33U) [ITR]		
	6200010870	S.COI C2520C-R33G-A (0.33U) [UK]		
	6200010740	S.COI C2520C-R27G-A [KOR]		
	6200010870	S.COI C2520C-R33G-A (0.33U) [AUS]		
	6200010870	S.COI C2520C-R33G-A (0.33U) [CHN]		
L1501	6200005011	S.COI NLV25T-100J	B	91.2/27.1
L1502	6200012170	S.COI MLG1608S R18J-T	B	79.5/38.3
L1503	6200012170	S.COI MLG1608S R18J-T	B	82.1/37.5
L1504	6200005011	S.COI NLV25T-100J	B	75.7/43.4
L1505	6200005190	S.COI MLF1608D R56K-T	T	80.7/51.7
L1506	6150005080	S.COI LS-535 (4KMH) [EUR]	T	68.7/55.4
	6150005080	S.COI LS-535 (4KMH) [FRA]		
	6150005080	S.COI LS-535 (4KMH) [ESP]		
	6150005070	S.COI LS-534 (4KMH) [USA]		
	6150005080	S.COI LS-535 (4KMH) [ITR]		
	6150005080	S.COI LS-535 (4KMH) [UK]		
	6150005070	S.COI LS-534 (4KMH) [KOR]		
	6150005080	S.COI LS-535 (4KMH) [AUS]		
	6150005080	S.COI LS-535 (4KMH) [CHN]		
L1507	6200005031	S.COI NLV25T-180J	B	71.7/62.2
L1508	6200005021	S.COI NLV25T-150J	B	77.4/79.6
L1951	6180003750	S.COI 7E10Y-101M-R-0231	B	34.6/110.9
L1952	6180003750	S.COI 7E10Y-101M-R-0231	B	54.7/113.4
L1953	6180003750	S.COI 7E10Y-101M-R-0231	B	14.0/111.9
L1954	6180003750	S.COI 7E10Y-101M-R-0231	B	24.5/119.8

Eqv.= This component is equivalent to the REF No. component listed above, and may be substituted on parts orders and repairs.

[MAIN UNIT]

REF NO.	PARTS NO.	DESCRIPTION	M.	H/V LOCATION
L2001	6200005011	S.COI NLV25T-100J	B	72.5/16.4
L2002	6200002041	S.COI NLV25T-101J	B	84.6/3.8
L2003	6200002041	S.COI NLV25T-101J	B	81.1/4.3
L2004	6200002041	S.COI NLV25T-101J	B	76.4/20.9
L2006	6200002041	S.COI NLV25T-101J	B	64.2/12.9
L2007	6200002041	S.COI NLV25T-101J	B	70.9/3.9
L2008	6200002041	S.COI NLV25T-101J	B	68.0/6.2
L2009	6200005011	S.COI NLV25T-100J	B	70.9/10.6
L2010	6200002041	S.COI NLV25T-101J	B	60.8/13.7
L2011	6200011300	S.COI EXCML16A270U	T	86.6/9.2
L2012	6200011300	S.COI EXCML16A270U	B	84.8/22.0
L2013	6200002041	S.COI NLV25T-101J	B	71.9/19.4
L2015	6200002041	S.COI NLV25T-101J	B	52.5/10.4
L2016	6200002041	S.COI NLV25T-101J	B	59.2/11.2
L2017	6200002041	S.COI NLV25T-101J	B	57.1/14.1
L2018	6200002041	S.COI NLV25T-101J	B	19.7/129.5
L2019	6200002041	S.COI NLV25T-101J	T	22.3/126.9
L2020	6200002041	S.COI NLV25T-101J	B	28.0/131.4
L2021	6200005011	S.COI NLV25T-100J	B	27.9/126.5
L2022	6200002041	S.COI NLV25T-101J	B	22.6/127.6
L2023	6200002041	S.COI NLV25T-101J	B	23.3/131.4
L2024	6200002041	S.COI NLV25T-101J	T	12.8/128.2
L2025	6200002041	S.COI NLV25T-101J	B	87.5/6.3
L2026	6200002041	S.COI NLV25T-101J	B	77.7/5.0
L2027	6200002041	S.COI NLV25T-101J	B	76.6/12.3
L2028	6200002041	S.COI NLV25T-101J	B	67.5/10.8
L2029	6200002041	S.COI NLV25T-101J	B	64.1/10.4
L2030	6200002041	S.COI NLV25T-101J	B	67.5/3.7
L2031	6200002041	S.COI NLV25T-101J	B	76.5/14.8
L2032	6200002041	S.COI NLV25T-101J	B	66.2/15.4
L2033	6200011300	S.COI EXCML16A270U	B	69.6/14.6
L2034	6200009300	S.COI ELJPA 100KF 10U	B	67.9/19.4
L2035	6200002041	S.COI NLV25T-101J	B	59.8/18.5
L2036	6200002041	S.COI NLV25T-101J	B	64.1/3.8
L2037	6200002041	S.COI NLV25T-101J	B	88.4/3.8
L2041	6180003750	S.COI 7E10Y-101M-R-0231	B	62.6/86.9
L2042	6200002861	S.COI NLV25T-4R7J	B	62.9/79.3
L2053	6200002041	S.COI NLV25T-101J	B	28.7/91.0
L2151	6200002041	S.COI NLV25T-101J	B	36.9/121.1
L2152	6200002041	S.COI NLV25T-101J	B	52.3/14.7
L2201	6200005011	S.COI NLV25T-100J	T	27.4/125.9
L2202	6200005011	S.COI NLV25T-100J	T	17.1/124.3
L2231	6200002041	S.COI NLV25T-101J	T	34.0/104.3
L2256	6200002041	S.COI NLV25T-101J	T	15.0/103.5
L2257	6200002041	S.COI NLV25T-101J	T	10.5/89.7
L2260	6200002041	S.COI NLV25T-101J	T	68.6/110.9
L2263	6200002041	S.COI NLV25T-101J	T	62.3/99.4
L2264	6200002041	S.COI NLV25T-101J	T	62.3/96.9
L2265	6200002041	S.COI NLV25T-101J	T	62.5/94.4
L2266	6200002041	S.COI NLV25T-101J	T	62.5/91.6
L2267	6200002041	S.COI NLV25T-101J	T	66.1/89.7
L2268	6200002041	S.COI NLV25T-101J	T	62.5/87.2
L2272	6200002041	S.COI NLV25T-101J	T	71.1/90.2
L2402	6200002041	S.COI NLV25T-101J	B	89.4/98.0
L2403	6200002041	S.COI NLV25T-101J	B	89.2/84.0
L2404	6200002041	S.COI NLV25T-101J	T	81.6/96.8
L2405	6200002041	S.COI NLV25T-101J	B	89.3/95.5
L2406	6200002041	S.COI NLV25T-101J	T	84.8/93.8
L2408	6200011300	S.COI EXCML16A270U	T	82.2/92.3
L2409	6200002041	S.COI NLV25T-101J	B	89.3/88.5
L2411	6200011300	S.COI EXCML16A270U	T	85.1/89.7
L2601	6200009330	S.COI SLF12555T-681MR43-PF	T	87.6/119.7
L2605	6200009330	S.COI SLF12555T-681MR43-PF	T	71.1/119.7
R1	7030011400	S.RES ERJ2GEJ 5R6 X (5.6)	T	79.7/17.0
R2	7030009270	S.RES ERJ2GEJ 821 X (820)	T	81.3/17.0
R3	7030009270	S.RES ERJ2GEJ 821 X (820)	T	79.7/17.9
R5	7030010090	S.RES ERJ2GEJ 180 X (18)	T	74.2/16.7
R6	7030008280	S.RES ERJ2GEJ 271 X (270)	T	74.8/15.8
R7	7030008280	S.RES ERJ2GEJ 271 X (270)	T	73.2/15.8
R8	7030009200	S.RES ERJ2GEJ 390 X (39)	T	73.1/18.5
R9	7030003400	S.RES ERJ3GEJ 471 V (470)	T	69.9/13.3
R10	7030005120	S.RES ERJ2GEJ 102 X (1K)	T	72.8/14.9
R11	7030005300	S.RES ERJ2GEJ 150 X (15)	T	62.1/16.0
R12	7030010040	S.RES ERJ2GEJ-JPW	T	62.9/13.9
R13	7030005090	S.RES ERJ2GEJ 104 X (100K)	T	66.8/20.6
R15	7030005090	S.RES ERJ2GEJ 104 X (100K)	T	70.4/10.5
R16	7030003860	S.RES ERJ3GE JPW V	T	62.5/12.4
R17	7030005090	S.RES ERJ2GEJ 104 X (100K)	T	76.4/15.8
R18	7030007270	S.RES ERJ2GEJ 151 X (150)	T	44.3/17.3
R19	7030003860	S.RES ERJ3GE JPW V	T	50.4/14.6
R20	7030009530	S.RES ERJ2GEJ 270 X (27)	T	69.5/19.8
R21	7030009530	S.RES ERJ2GEJ 270 X (27)	T	65.5/22.8
R22	7030010040	S.RES ERJ2GEJ-JPW	T	78.1/13.8
R23				

[MAIN UNIT]

REF NO.	PARTS NO.	DESCRIPTION	M.	H/V LOCATION
R105	7030005580	S.RES ERJ2GEJ 560 X (56)	T	15.8/22.4
R106	7030005000	S.RES ERJ2GEJ 471 X (470)	T	13.2/20.5
R107	7030005000	S.RES ERJ2GEJ 471 X (470)	T	10.9/22.1
R108	7030005000	S.RES ERJ2GEJ 471 X (470)	T	10.9/23.0
R111	7030005000	S.RES ERJ2GEJ 471 X (470)	T	10.9/21.2
R112	7030005090	S.RES ERJ2GEJ 104 X (100K)	T	25.6/12.6
R113	7030005090	S.RES ERJ2GEJ 104 X (100K)	T	26.9/5.7
R114	7030009280	S.RES ERJ2GEJ 391 X	B	33.2/23.4
R115	7030009280	S.RES ERJ2GEJ 391 X	B	34.1/22.3
R116	7030009280	S.RES ERJ2GEJ 391 X	T	22.3/21.3
R117	7030009280	S.RES ERJ2GEJ 391 X	T	20.7/21.3
R118	7030009280	S.RES ERJ2GEJ 391 X	B	41.0/23.3
R119	7030009280	S.RES ERJ2GEJ 391 X	B	41.0/22.4
R120	7030005090	S.RES ERJ2GEJ 104 X (100K)	B	50.4/23.6
R121	7030005090	S.RES ERJ2GEJ 104 X (100K)	T	44.1/22.3
R122	7030009280	S.RES ERJ2GEJ 391 X	T	7.8/20.3
R123	7030009280	S.RES ERJ2GEJ 391 X	T	7.8/19.4
R125	7030009280	S.RES ERJ2GEJ 391 X	T	35.6/20.8
R126	7030009280	S.RES ERJ2GEJ 391 X	T	27.1/4.3
R127	7030009280	S.RES ERJ2GEJ 391 X	T	25.5/4.8
R128	7030009280	S.RES ERJ2GEJ 391 X	T	35.6/19.4
R202	7030005090	S.RES ERJ2GEJ 104 X (100K)	T	18.1/31.2
R203	7030005090	S.RES ERJ2GEJ 104 X (100K)	T	42.9/60.0
R204	7030005090	S.RES ERJ2GEJ 104 X (100K)	B	43.0/54.4
R205	7030009280	S.RES ERJ2GEJ 391 X	T	19.4/54.2
R206	7030005090	S.RES ERJ2GEJ 104 X (100K)	B	43.0/51.5
R207	7030005090	S.RES ERJ2GEJ 104 X (100K)	B	43.0/50.6
R208	7030005090	S.RES ERJ2GEJ 104 X (100K)	B	46.5/45.1
R216	7030005090	S.RES ERJ2GEJ 104 X (100K)	B	44.3/43.3
R217	7030005050	S.RES ERJ2GEJ 103 X (10K)	T	18.1/30.3
R218	7030004970	S.RES ERJ2GEJ 470 X (47)	T	21.9/30.0
R225	7030005050	S.RES ERJ2GEJ 103 X (10K)	T	19.1/29.1
R226	7030009280	S.RES ERJ2GEJ 391 X	T	17.6/54.2
R227	7030005120	S.RES ERJ2GEJ 102 X (1K)	T	30.9/31.0
R228	7030009140	S.RES ERJ2GEJ 272 X (2.7K)	T	30.9/29.2
R301	7030009280	S.RES ERJ2GEJ 391 X	T	44.5/28.8
R302	7030009280	S.RES ERJ2GEJ 391 X	T	38.6/27.9
R303	7030004970	S.RES ERJ2GEJ 470 X (47)	T	52.5/38.9
R304	7030004980	S.RES ERJ2GEJ 101 X (100)	T	55.1/35.6
R305	7030005120	S.RES ERJ2GEJ 102 X (1K)	T	60.0/33.8
R306	7030008280	S.RES ERJ2GEJ 271 X (270)	T	55.4/28.8
R307	7030004980	S.RES ERJ2GEJ 101 X (100)	T	56.8/35.6
R308	7030007290	S.RES ERJ2GEJ 222 X (2.2K)	T	59.2/30.1
R309	7030008280	S.RES ERJ2GEJ 271 X (270)	T	58.6/29.2
R310	7030005090	S.RES ERJ2GEJ 104 X (100K)	T	50.1/31.7
R311	7030009280	S.RES ERJ2GEJ 391 X	T	65.4/31.4
R312	7030009280	S.RES ERJ2GEJ 391 X	T	63.8/31.4
R314	7030009280	S.RES ERJ2GEJ 391 X	T	73.4/32.5
R315	7030009280	S.RES ERJ2GEJ 391 X	T	74.9/33.8
R401	7030010040	S.RES ERJ2GEJ-JPW	T	75.0/29.6
R402	7030010040	S.RES ERJ2GEJ-JPW	T	75.0/27.8
R403	7030004980	S.RES ERJ2GEJ 101 X (100)	T	76.7/29.7
R404	7030010040	S.RES ERJ2GEJ-JPW	T	72.0/23.2
R405	7030004980	S.RES ERJ2GEJ 101 X (100)	T	86.8/23.9
R406	7030005580	S.RES ERJ2GEJ 560 X (56)	T	73.1/30.6
R407	7030005580	S.RES ERJ2GEJ 560 X (56)	T	72.0/25.0
R408	7030010040	S.RES ERJ2GEJ-JPW	T	83.4/19.3
R411	7030007260	S.RES ERJ2GEJ 330 X (33)	T	80.1/29.5
R412	7030007260	S.RES ERJ2GEJ 330 X (33)	T	80.1/26.8
R414	7030004980	S.RES ERJ2GEJ 101 X (100)	T	78.3/29.7
R416	7030010090	S.RES ERJ2GEJ 180 X (18)	T	88.4/24.5
R417	7030008280	S.RES ERJ2GEJ 271 X (270)	T	89.3/25.3
R418	7030008280	S.RES ERJ2GEJ 271 X (270)	T	88.0/22.9
R421	7030010090	S.RES ERJ2GEJ 180 X (18)	B	88.6/20.2
R422	7030008280	S.RES ERJ2GEJ 271 X (270)	B	90.2/20.2
R423	7030008280	S.RES ERJ2GEJ 271 X (270)	B	90.2/19.3
R424	7030005530	S.RES ERJ2GEJ 100 X (10)	T	88.5/21.6
R501	7030005120	S.RES ERJ2GEJ 102 X (1K)	T	91.3/35.6
R502	7030005120	S.RES ERJ2GEJ 102 X (1K)	T	92.9/34.4
R509	7030005580	S.RES ERJ2GEJ 560 X (56)	T	83.5/33.1
R510	7030010040	S.RES ERJ2GEJ-JPW	T	83.5/34.1
R512	7030004980	S.RES ERJ2GEJ 101 X (100)	T	81.8/34.1
R517	7030010040	S.RES ERJ2GEJ-JPW	T	80.0/31.0
R518	7030007290	S.RES ERJ2GEJ 222 X (2.2K)	T	79.6/37.1
R519	7030007290	S.RES ERJ2GEJ 222 X (2.2K)	T	79.6/38.9
R520	7030005120	S.RES ERJ2GEJ 102 X (1K)	T	89.2/39.2
R521	7030005000	S.RES ERJ2GEJ 471 X (470)	T	84.3/40.4
R523	7030005120	S.RES ERJ2GEJ 102 X (1K)	T	91.3/34.7
R524	7030005120	S.RES ERJ2GEJ 102 X (1K)	B	86.9/30.2
R601	7030005000	S.RES ERJ2GEJ 471 X (470)	B	88.6/40.0
R602	7030005000	S.RES ERJ2GEJ 471 X (470)	T	91.1/39.6
R603	7030005000	S.RES ERJ2GEJ 471 X (470)	T	89.2/41.0
R604	7030005000	S.RES ERJ2GEJ 471 X (470)	B	78.7/45.9
R605	7030010040	S.RES ERJ2GEJ-JPW	T	68.3/45.3
R606	7030005090	S.RES ERJ2GEJ 104 X (100K)	T	67.1/47.4
R607	7030005120	S.RES ERJ2GEJ 102 X (1K)	T	66.7/45.3
R701	7030005220	S.RES ERJ2GEJ 223 X (22K)	T	61.2/53.0
R702	7030005120	S.RES ERJ2GEJ 102 X (1K)	T	64.3/44.0
R703	7030004970	S.RES ERJ2GEJ 470 X (47)	T	50.8/44.1
R705	7030004990	S.RES ERJ2GEJ 221 X (220)	T	59.0/51.6
R706	7030009270	S.RES ERJ2GEJ 821 X (820)	T	64.6/56.0
R707	7030004980	S.RES ERJ2GEJ 101 X (100)	T	59.6/57.0
R708	7030007290	S.RES ERJ2GEJ 222 X (2.2K)	T	63.9/58.6
R709	7030005210	S.RES ERJ2GEJ 822 X (8.2K)	T	59.6/55.2
R710	7030005120	S.RES ERJ2GEJ 102 X (1K)	T	59.9/62.5
R711	7030009140	S.RES ERJ2GEJ 272 X (2.7K)	T	50.6/51.5
R712	7030005120	S.RES ERJ2GEJ 102 X (1K)	T	51.2/50.6
R713	7030005050	S.RES ERJ2GEJ 103 X (10K)	T	57.2/51.6
R715	7030004970	S.RES ERJ2GEJ 470 X (47)	T	52.2/54.2
R716	7030005120	S.RES ERJ2GEJ 102 X (1K)	T	51.3/57.5
R717	7030007300	S.RES ERJ2GEJ 332 X (3.3K)	T	52.2/51.5
R718	7510001461	S.THE NTCG16 3NH 471JT	T	63.3/54.0
R801	7030008280	S.RES ERJ2GEJ 271 X (270)	T	86.9/57.2
R802	7030005120	S.RES ERJ2GEJ 102 X (1K)	T	65.3/60.9
R803	7030005120	S.RES ERJ2GEJ 102 X (1K)	T	72.0/65.0

Eqv.= This component is equivalent to the REF No. component listed above, and may be substituted on parts orders and repairs.

[MAIN UNIT]

REF NO.	PARTS NO.	DESCRIPTION	M.	H/V LOCATION
R804	7030005530	S.RES ERJ2GEJ 100 X (10)	T	91.2/57.2
R805	7030010090	S.RES ERJ2GEJ 180 X (18)	T	84.8/54.4
R806	7030008280	S.RES ERJ2GEJ 271 X (270)	T	85.3/55.3
R807	7030005120	S.RES ERJ2GEJ 102 X (1K)	T	62.8/64.6
R808	7030004970	S.RES ERJ2GEJ 470 X (47)	T	62.3/69.4
R809	7030008280	S.RES ERJ2GEJ 271 X (270)	T	82.8/60.6
R810	7030010090	S.RES ERJ2GEJ 180 X (18)	T	84.4/60.6
R811	7030008280	S.RES ERJ2GEJ 271 X (270)	T	82.8/59.7
R904	7030003860	S.RES ERJ3GE JPW V	T	36.5/68.1
R905	7030004980	S.RES ERJ2GEJ 101 X (100)	T	39.3/64.6
R906	7030007290	S.RES ERJ2GEJ 222 X (2.2K)	T	39.3/66.6
R908	7030005000	S.RES ERJ2GEJ 471 X (470)	T	35.7/62.0
R909	7030008410	S.RES ERJ2GEJ 392 X (3.9K)	T	34.3/68.4
R912	7030005210	S.RES ERJ2GEJ 822 X (8.2K)	T	34.3/66.6
R913	7030007300	S.RES ERJ2GEJ 332 X (3.3K)	T	40.6/75.1
R914	7030009290	S.RES ERJ2GEJ 562 X (5.6K)	T	35.6/71.5
R915	7030007290	S.RES ERJ2GEJ 222 X (2.2K)	T	36.6/71.0
R916	7030005050	S.RES ERJ2GEJ 103 X (10K)	T	37.2/75.5
R917	7030004970	S.RES ERJ2GEJ 470 X (47)	T	34.3/69.3
R918	7030007290	S.RES ERJ2GEJ 222 X (2.2K)	B	31.5/72.1
R919	7030004980	S.RES ERJ2GEJ 101 X (100)	T	31.5/72.2
R1009	7030009290	S.RES ERJ2GEJ 562 X (5.6K)	T	25.9/72.9
R1018	7030007290	S.RES ERJ2GEJ 222 X (2.2K)	T	20.3/75.1
R1019	7030005050	S.RES ERJ2GEJ 103 X (10K)	T	20.3/76.9
R1020	7030005000	S.RES ERJ2GEJ 471 X (470)	T	12.7/77.6
R1022	7510001461	S.THE NTCG16 3NH 471JT	T	14.8/76.8
R1023	7030008370	S.RES ERJ2GEJ 561 X (560)	T	15.3/77.9
R1024	7030004980	S.RES ERJ2GEJ 101 X (100)	T	12.7/74.9
R1025	7030007260	S.RES ERJ2GEJ 330 X (33)	T	12.7/76.7
R1027	7030005120	S.RES ERJ2GEJ 102 X (1K)	T	4.6/87.7
R1201	7030005000	S.RES ERJ2GEJ 471 X (470)	T	25.7/77.9
R1202	7030005240	S.RES ERJ2GEJ 473 X (47K)	T	24.1/78.6
R1203	7030005240	S.RES ERJ2GEJ 473 X (47K)	T	25.7/78.6
R1204	7030005240	S.RES ERJ2GEJ 473 X (47K)	T	20.2/79.2
R1205	7030005000	S.RES ERJ2GEJ 471 X (470)	T	20.2/78.3
R1206	7030005090	S.RES ERJ2GEJ 104 X (100K)	T	21.8/79.3
R1207	7030005240	S.RES ERJ2GEJ 473 X (47K)	T	18.0/83.6
R1208	7030004980	S.RES ERJ2GEJ 101 X (100)	T	9.4/79.8
R1209	7030004980	S.RES ERJ2GEJ 101 X (100)	T	16.5/79.9
R1211	7030005120	S.RES ERJ2GEJ 102 X (1K)	T	12.7/79.4
R1212	7030005120	S.RES ERJ2GEJ 102 X (1K)	T	11.1/78.5
R1213	7030005120	S.RES ERJ2GEJ 102 X (1K)	T	11.1/79.4
R1215	7030007350	S.RES ERJ2GEJ 393 X (39K)	T	8.1/81.3
R1216	7030007290	S.RES ERJ2GEJ 222 X (2.2K)	T	9.5/83.5
R1217	7030007290	S.RES ERJ2GEJ 222 X (2.2K)	T	8.0/82.9
R1218	7030005050	S.RES ERJ2GEJ 103 X (10K)	T	7.5/78.6
R1219	7030005050	S.RES ERJ2GEJ 103 X (10K)	T	7.5/79.8
R1301	7030010040	S.RES ERJ2GEJ-JPW	T	15.3/74.9
R1302	7030005120	S.RES ERJ2GEJ 102 X (1K)	T	15.3/72.7
R1303	7030005120	S.RES ERJ2GEJ 102 X (1K)	T	12.7/74.0
R1304	7030005120	S.RES ERJ2GEJ 102 X (1K)	T	14.9/68.3
R1305	7030005120	S.RES ERJ2GEJ 102 X (1K)	T	16.2/63.9
R1306	7030005120	S.RES ERJ2GEJ 102 X (1K)	T	10.9/56.8
R1308	7030007300	S.RES ERJ2GEJ 332 X (3.3K)	T	13.0/67.4
R1309	7030005120	S.RES ERJ2GEJ 102 X (1K)	T	11.4/66.5
R1310	7510001451	S.THE NTCG16 4BH 472JT	T	12.3/68.5
R1401	7030005120	S.RES ERJ2GEJ 102 X (1K)	B	45.4/72.4
R1402	7030008010	S.RES ERJ2GEJ 123 X (12K)	B	43.7/72.4
R1403	7030007290	S.RES ERJ2GEJ 222 X (2.2K)	B	44.6/73.4
R1404	7030007280	S.RES ERJ2GEJ 331 X (330)	B	44.6/75.3
R1405	7030004970	S.RES ERJ2GEJ 470 X (47)	B	42.1/71.5
R1406	7030005290	S.RES ERJ2GEJ 682 X (6.8K)	B	38.7/79.9
R1407	7030005120	S.RES ERJ2GEJ 102 X (1K)	B	38.7/79.0
R1408	7030007280	S.RES ERJ2GEJ 331 X (330)	B	38.7/80.8
R1409	7030004970	S.RES ERJ2GEJ 470 X (47)	B	34.7/80.0
R1414	7030007340	S.RES ERJ2GEJ 153 X (15K)	B	20.3/76.4
R1416	7030008410	S.RES ERJ2GEJ 392 X (3.9K)	B	19.5/83.1
R1420	7030004990	S.RES ERJ2GEJ 221 X (220)	B	25.1/76.9
R1421	7030007270	S.RES ERJ2GEJ 151 X (150)	B	23.2/75.9
R1422	7030004990	S.RES ERJ2GEJ 221 X (220)	B	23.3/76.8
R1501	7030010040	S.RES ERJ2GEJ-JPW	B	72.4/38.3
R1502	7030005100	S.RES ERJ2GEJ 154 X (150K)	B	86.5/55.4
R1503	7030005100	S.RES ERJ2GEJ 154 X (150K)	B	85.8/54.2
R1504	7030004970	S.RES ERJ2GEJ 470 X (47)	B	72.4/40.3
R1505	7030007290	S.RES ERJ2GEJ 222 X (2.2K)	B	71.8/54.0
R1506	7030007350	S.RES ERJ2GEJ		

[MAIN UNIT]

REF NO.	PARTS NO.	DESCRIPTION	M.	H/V LOCATION
R1612	7030005060	S.RES ERJ2GGEJ 333 X (33K)	T	3.4/42.3
R1613	7030003860	S.RES ERJ3GGEJ JPW V	T	6.7/48.7
R1614	7030007310	S.RES ERJ2GGEJ 155 X (1.5M)	T	6.1/45.8
R1615	7030005040	S.RES ERJ2GGEJ 472 X (4.7K)	T	4.2/35.4
R1616	7030005090	S.RES ERJ2GGEJ 104 X (100K)	T	6.7/35.4
R1617	7030005720	S.RES ERJ2GGEJ 563 X (56K)	T	3.5/38.2
R1618	7310005540	S.TRI TMC3ADC14X (10K)	T	3.5/46.3
R1619	7030005080	S.RES ERJ2GGEJ 823 X (82K)	T	2.6/43.3
	7030005080	S.RES ERJ2GGEJ 823 X (82K)	[EUR]	
	7030005080	S.RES ERJ2GGEJ 823 X (82K)	[FRA]	
	7030005080	S.RES ERJ2GGEJ 823 X (82K)	[ESP]	
	7030005080	S.RES ERJ2GGEJ 823 X (82K)	[USA]	
	7030005080	S.RES ERJ2GGEJ 823 X (82K)	[ITR]	
	7030005080	S.RES ERJ2GGEJ 823 X (82K)	[UK]	
	7030005080	S.RES ERJ2GGEJ 823 X (82K)	[KOR]	
	7030005720	S.RES ERJ2GGEJ 563 X (56K)	[AUS]	
	7030005080	S.RES ERJ2GGEJ 823 X (82K)	[CHN]	
R1620	7030008290	S.RES ERJ2GGEJ 183 X (18K)	T	3.5/37.3
R1621	7030005160	S.RES ERJ2GGEJ 105 X (1M)	T	6.7/37.2
R1622	7030010040	S.RES ERJ2GGEJ-JPW	T	5.1/37.3
R1623	7030005000	S.RES ERJ2GGEJ 471 X (470)	T	12.0/46.9
R1624	7030007250	S.RES ERJ2GGEJ 220 X (22)	T	14.9/38.3
R1625	7030004990	S.RES ERJ2GGEJ 221 X (220)	T	13.6/32.6
R1626	7030005050	S.RES ERJ2GGEJ 103 X (10K)	T	10.3/34.6
R1627	7030007320	S.RES ERJ2GGEJ 225 X (2.2M)	T	10.3/35.5
R1628	7030005120	S.RES ERJ2GGEJ 102 X (1K)	T	4.9/30.2
R1629	7030005050	S.RES ERJ2GGEJ 103 X (10K)	T	4.9/29.9
R1630	7030004980	S.RES ERJ2GGEJ 101 X (100)	T	8.3/45.8
R1631	7030005090	S.RES ERJ2GGEJ 104 X (100K)	T	9.9/37.3
R1634	7030005040	S.RES ERJ2GGEJ 472 X (4.7K)	T	10.3/33.7
R1636	7030007320	S.RES ERJ2GGEJ 225 X (2.2M)	T	13.0/31.7
R1637	7030007320	S.RES ERJ2GGEJ 225 X (2.2M)	T	12.0/46.0
R1638	7030008280	S.RES ERJ2GGEJ 271 X (270)	T	10.9/48.9
R1639	7030005120	S.RES ERJ2GGEJ 102 X (1K)	T	14.6/50.5
R1640	7030005090	S.RES ERJ2GGEJ 104 X (100K)	T	11.0/31.6
R1641	7030007320	S.RES ERJ2GGEJ 225 X (2.2M)	T	13.0/30.8
R1642	7030005120	S.RES ERJ2GGEJ 102 X (1K)	T	22.9/55.2
R1701	7030009320	S.RES ERJ2GGEJ 4R7 X (4.7)	T	48.1/45.3
R1702	7030007280	S.RES ERJ2GGEJ 331 X (330)	B	52.2/44.7
R1703	7030007280	S.RES ERJ2GGEJ 331 X (330)	B	53.8/43.8
R1704	7030007280	S.RES ERJ2GGEJ 331 X (330)	B	53.8/44.7
R1705	7030009320	S.RES ERJ2GGEJ 4R7 X (4.7)	T	48.1/46.2
R1706	7030007280	S.RES ERJ2GGEJ 331 X (330)	B	53.6/64.2
R1707	7030007280	S.RES ERJ2GGEJ 331 X (330)	B	55.7/64.8
R1708	7030007280	S.RES ERJ2GGEJ 331 X (330)	B	55.7/65.7
R1901	7030005090	S.RES ERJ2GGEJ 104 X (100K)	B	20.0/14.0
R1902	7030011290	S.RES ERJ12YJ1R8U (1.8)	B	12.4/45.9
R1952	7030009980	S.RES ERJ12RSJR15U	B	42.6/102.3
R1953	7030009980	S.RES ERJ12RSJR15U	B	42.6/98.6
R1954	7030005170	S.RES ERJ2GGEJ 474 X (470K)	B	42.7/111.4
R1955	7030005511	S.RES ERA3YED 303V (30K)	B	44.8/107.4
R1956	7030005110	S.RES ERJ2GGEJ 224 X (220K)	B	33.7/105.2
R1957	7030007350	S.RES ERJ2GGEJ 393 X (39K)	B	35.3/104.3
R1958	7030005720	S.RES ERJ2GGEJ 563 X (56K)	B	35.3/103.4
R1981	7030008240	S.RES ERJ12YR00U	B	83.1/109.0
R2002	7030010040	S.RES ERJ2GGEJ-JPW	B	36.9/12.8
R2003	7030008240	S.RES ERJ12YR00U	T	55.7/7.9
R2004	7030004990	S.RES ERJ2GGEJ 221 X (220)	B	59.8/9.3
R2005	7030004990	S.RES ERJ2GGEJ 221 X (220)	B	59.1/3.0
R2006	7030004990	S.RES ERJ2GGEJ 221 X (220)	B	60.7/3.7
R2007	7030004990	S.RES ERJ2GGEJ 221 X (220)	B	60.7/4.6
R2008	7030010040	S.RES ERJ2GGEJ-JPW	B	34.1/17.7
R2010	7030010040	S.RES ERJ2GGEJ-JPW	B	32.5/15.2
R2011	7030006210	S.RES ERJ12YJ4R7U (4.7)	B	13.2/26.4
R2012	7030005120	S.RES ERJ2GGEJ 102 X (1K)	B	32.5/17.3
R2101	7030005090	S.RES ERJ2GGEJ 104 X (100K)	T	26.1/113.8
R2102	7030005090	S.RES ERJ2GGEJ 104 X (100K)	T	33.2/114.2
R2103	7030005090	S.RES ERJ2GGEJ 104 X (100K)	T	30.7/123.4
R2104	7030005090	S.RES ERJ2GGEJ 104 X (100K)	T	28.1/123.2
R2105	7030005090	S.RES ERJ2GGEJ 104 X (100K)	T	32.4/118.8
R2106	7030005720	S.RES ERJ2GGEJ 563 X (56K)	T	25.0/115.5
R2107	7030005720	S.RES ERJ2GGEJ 563 X (56K)	T	31.6/114.7
R2108	7030005100	S.RES ERJ2GGEJ 154 X (150K)	T	30.8/122.3
R2109	7030007350	S.RES ERJ2GGEJ 393 X (39K)	T	27.1/122.3
R2110	7030005090	S.RES ERJ2GGEJ 104 X (100K)	T	44.3/111.9
R2111	7030005090	S.RES ERJ2GGEJ 104 X (100K)	T	44.8/110.1
R2112	7030005090	S.RES ERJ2GGEJ 104 X (100K)	T	54.2/110.9
R2113	7030005090	S.RES ERJ2GGEJ 104 X (100K)	T	54.2/111.8
R2114	7030005100	S.RES ERJ2GGEJ 154 X (150K)	T	44.8/112.8
R2115	7030005100	S.RES ERJ2GGEJ 154 X (150K)	T	44.8/109.2
R2116	7030005100	S.RES ERJ2GGEJ 154 X (150K)	T	54.4/110.0
R2117	7030005100	S.RES ERJ2GGEJ 154 X (150K)	T	54.2/112.7
R2118	7030005090	S.RES ERJ2GGEJ 104 X (100K)	T	54.2/120.6
R2119	7030005090	S.RES ERJ2GGEJ 104 X (100K)	T	54.2/121.8
R2120	7030008300	S.RES ERJ2GGEJ 184 X (180K)	T	44.8/122.1
R2121	7030008300	S.RES ERJ2GGEJ 184 X (180K)	T	42.9/121.3
R2122	7030005100	S.RES ERJ2GGEJ 154 X (150K)	T	54.2/119.7
R2123	7030006610	S.RES ERJ2GGEJ 394 X (390K)	T	54.2/122.8
R2124	7030005110	S.RES ERJ2GGEJ 224 X (220K)	T	44.8/123.0
R2125	7030005110	S.RES ERJ2GGEJ 224 X (220K)	T	44.9/119.4
R2126	7030010040	S.RES ERJ2GGEJ-JPW	T	33.1/116.5
R2128	7030005000	S.RES ERJ2GGEJ 471 X (470)	T	32.3/123.2
R2129	7030005000	S.RES ERJ2GGEJ 471 X (470)	T	54.2/118.8
R2131	7030005090	S.RES ERJ2GGEJ 104 X (100K)	B	39.9/122.1
R2132	7030005090	S.RES ERJ2GGEJ 104 X (100K)	T	42.9/115.2
R2133	7030005090	S.RES ERJ2GGEJ 104 X (100K)	T	40.6/114.1
R2134	7030005090	S.RES ERJ2GGEJ 104 X (100K)	T	36.6/114.1
R2135	7030005090	S.RES ERJ2GGEJ 104 X (100K)	T	35.0/114.2
R2136	7030005000	S.RES ERJ2GGEJ 471 X (470)	T	26.5/123.2
R2137	7030005230	S.RES ERJ2GGEJ 334 X (330K)	T	43.3/123.7
R2138	7030005230	S.RES ERJ2GGEJ 334 X (330K)	T	42.9/122.2
R2139	7030004980	S.RES ERJ2GGEJ 101 X (100)	T	25.0/116.4
R2140	7030004980	S.RES ERJ2GGEJ 101 X (100)	T	32.0/115.6
R2141	7030010040	S.RES ERJ2GGEJ-JPW	T	44.8/113.7
R2142	7030010040	S.RES ERJ2GGEJ-JPW	T	52.7/109.0
R2143	7030010040	S.RES ERJ2GGEJ-JPW	T	56.0/110.0

Eqv.= This component is equivalent to the REF No. component listed above, and may be substituted on parts orders and repairs.

[MAIN UNIT]

REF NO.	PARTS NO.	DESCRIPTION	M.	H/V LOCATION
R2144	7030010040	S.RES ERJ2GGEJ-JPW	T	51.3/115.2
R2145	7030010040	S.RES ERJ2GGEJ-JPW	T	58.1/123.6
R2146	7030010040	S.RES ERJ2GGEJ-JPW	T	46.3/124.0
R2147	7030010040	S.RES ERJ2GGEJ-JPW	T	46.0/118.5
R2151	7030005240	S.RES ERJ2GGEJ 473 X (47K)	T	52.4/101.8
R2152	7030005120	S.RES ERJ2GGEJ 102 X (1K)	T	56.5/107.2
R2153	7030005240	S.RES ERJ2GGEJ 473 X (47K)	T	24.9/112.6
R2154	7030005120	S.RES ERJ2GGEJ 102 X (1K)	T	25.6/111.6
R2155	7030005240	S.RES ERJ2GGEJ 473 X (47K)	T	46.2/104.7
R2156	7030005120	S.RES ERJ2GGEJ 102 X (1K)	T	46.2/105.6
R2157	7030005530	S.RES ERJ2GGEJ 100 X (10)	B	33.3/120.8
R2158	7030005530	S.RES ERJ2GGEJ 100 X (10)	B	33.3/119.9
R2159	7030005530	S.RES ERJ2GGEJ 100 X (10)	B	35.1/118.4
R2160	7030005530	S.RES ERJ2GGEJ 100 X (10)	B	40.7/94.4
R2161	7030005530	S.RES ERJ2GGEJ 100 X (10)	B	40.7/95.3
R2162	7030005530	S.RES ERJ2GGEJ 100 X (10)	B	30.2/93.8
R2163	7030005530	S.RES ERJ2GGEJ 100 X (10)	B	31.0/95.9
R2164	7030005530	S.RES ERJ2GGEJ 100 X (10)	B	30.2/94.7
R2165	7030005530	S.RES ERJ2GGEJ 100 X (10)	B	29.4/95.9
R2166	7030005530	S.RES ERJ2GGEJ 100 X (10)	T	51.9/93.4
R2167	7030005530	S.RES ERJ2GGEJ 100 X (10)	T	51.9/94.3
R2168	7030005530	S.RES ERJ2GGEJ 100 X (10)	T	51.9/95.2
R2169	7030005120	S.RES ERJ2GGEJ 102 X (1K)	T	8.8/118.6
R2170	7030005170	S.RES ERJ2GGEJ 474 X (470K)	T	5.0/104.5
R2171	7030005240	S.RES ERJ2GGEJ 473 X (47K)	T	9.8/114.3
R2172	7030005240	S.RES ERJ2GGEJ 473 X (47K)	T	5.1/112.5
R2174	7030005170	S.RES ERJ2GGEJ 474 X (470K)	T	5.0/105.4
R2175	7030005170	S.RES ERJ2GGEJ 474 X (470K)	T	5.1/111.5
R2176	7030005170	S.RES ERJ2GGEJ 474 X (470K)	T	11.4/114.3
R2177	7030005210	S.RES ERJ2GGEJ 822 X (8.2K)	T	3.4/108.1
R2202	7030010040	S.RES ERJ2GGEJ-JPW	T	26.5/124.1
R2203	7030005080	S.RES ERJ2GGEJ 823 X (82K)	T	25.1/122.4
R2204	7030005050	S.RES ERJ2GGEJ 103 X (10K)	T	23.5/122.7
R2205	7030005040	S.RES ERJ2GGEJ 472 X (4.7K)	T	18.2/118.3
R2206	7030007270	S.RES ERJ2GGEJ 151 X (150)	T	12.6/118.8
R2207	7030005090	S.RES ERJ2GGEJ 104 X (100K)	T	23.2/121.5
R2208	7030005090	S.RES ERJ2GGEJ 104 X (100K)	T	19.1/119.2
R2209	7030004980	S.RES ERJ2GGEJ 101 X (100)	T	21.1/116.6
R2211	7030005230	S.RES ERJ2GGEJ 334 X (330K)	T	14.6/123.4
R2212	7030005310	S.RES ERJ2GGEJ 124 X (120K)	T	13.0/123.4
R2213	7030008010	S.RES ERJ2GGEJ 123 X (12K)	T	12.4/124.3
R2214	7030005050	S.RES ERJ2GGEJ 103 X (10K)	T	8.8/117.7
R2215	7030005040	S.RES ERJ2GGEJ 472 X (4.7K)	T	11.2/120.6
R2217	7030007280	S.RES ERJ2GGEJ 331 X (330)	T	24.9/121.5
R2218	7030007270	S.RES ERJ2GGEJ 151 X (150)	T	15.5/127.5
R2219	7030007280	S.RES ERJ2GGEJ 331 X (330)	T	17.7/126.1
R2220	7030008280	S.RES ERJ2GGEJ 271 X (270)	T	9.6/126.1
R2221	7030005050	S.RES ERJ2GGEJ 103 X (10K)	T	16.1/120.6
R2230	7030010900	S.RES ERJ3GGEYJ 750 V (75)	T	40.5/105.8
R2231	7030005050	S.RES ERJ2GGEJ 103 X (10K)	T	4.5/118.2
R2232	7030005050	S.RES ERJ2GGEJ 103 X (10K)	T	54.7/117.5
R2251	7030004990	S.RES ERJ2GGEJ 221 X (220)	T	6.2/96.9
R2254	7030004990	S.RES ERJ2GGEJ 221 X (220)	B	6.8/100.8
R2255	7030004990	S.RES ERJ2GGEJ 221 X (220)	B	6.8/101.7
R2256	7030004990	S.RES ERJ2GGEJ 221 X (220)	B	6.8/102.6
R2257	7030004990	S.RES ERJ2GGEJ 221 X (220)	B	75.3/109.0
R2258	7030004990	S.RES ERJ2GGEJ 221 X (220)	B	71.0/106.6
R2259	7030004990	S.RES ERJ2GGEJ 221 X (220)	B	75.3/107.8
R2260	7030004990	S.RES ERJ2GGEJ 221 X (220)	B	71.0/105.6
R2261	7030004990	S.RES ERJ2GGEJ 221 X (220)	B	75.3/106.6
R2262	7030004990	S.RES ERJ2GGEJ 221 X (220)	B	75.5/104.6
R2263	7030004990	S.RES ERJ2GGEJ 221 X (220)	B	71.0/106.6
R2264	7030004990	S.RES ERJ2GGEJ 221 X (220)	B	72.3/103.6
R2267	7030004990	S.RES ERJ2GGEJ 221 X (220)	T	78.6/104.2
R2268	7030004990	S.RES ERJ2GGEJ 221 X (220)	T	78.6/103.3
R2269	7030004990	S.RES ERJ2GGEJ 221 X (220)	T	78.6/102.4
R2270	7030004970	S.RES ERJ2GGEJ 470 X (47)	T	76.6/101.8
R2271	7030004990	S.RES ERJ2GGEJ 221 X (220)	T	76.6/100.9
R2272	7030004990	S.RES ERJ2GGEJ 221 X (220)	B	78.1/97.8
R2273	7030004990	S.RES ERJ2GGEJ 221 X (220)		

[MAIN UNIT]

REF NO.	PARTS NO.	DESCRIPTION	M.	H/V LOCATION
R2510	7030005120	S.RES ERJ2GEJ 102 X (1K)	B	17.4/92.8
R2513	7030005000	S.RES ERJ2GEJ 471 X (470)	B	15.8/94.0
R2551	7030005120	S.RES ERJ2GEJ 102 X (1K)	B	43.0/123.2
R2552	7030005120	S.RES ERJ2GEJ 102 X (1K)	B	43.0/122.3
R2555	7030004980	S.RES ERJ2GEJ 101 X (100)	B	51.5/119.4
R2556	7030005040	S.RES ERJ2GEJ 472 X (4.7K)	B	44.5/125.2
R2559	7030010040	S.RES ERJ2GEJ-JPW	B	49.5/124.7
R2560	7030008410	S.RES ERJ2GEJ 392 X (3.9K)	B	49.5/125.6
R2561	7030008410	S.RES ERJ2GEJ 392 X (3.9K)	B	53.0/124.7
R2562	7030008410	S.RES ERJ2GEJ 392 X (3.9K)	B	53.9/122.9
R2564	7030005090	S.RES ERJ2GEJ 104 X (100K)	B	46.1/126.1
R2565	7030009280	S.RES ERJ2GEJ 391 X	B	41.9/116.9
R2566	7030005050	S.RES ERJ2GEJ 103 X (10K)	B	59.1/126.8
R2567	7030005050	S.RES ERJ2GEJ 103 X (10K)	B	60.7/126.8
R2568	7030005040	S.RES ERJ2GEJ 472 X (4.7K)	B	47.8/124.7
R2569	7030005040	S.RES ERJ2GEJ 472 X (4.7K)	B	46.1/125.2
R2601	7030010040	S.RES ERJ2GEJ-JPW	B	66.8/123.5
R2602	7030005000	S.RES ERJ2GEJ 471 X (470)	B	57.2/122.7
R2603	7030005240	S.RES ERJ2GEJ 473 X (47K)	B	63.5/121.8
R2604	7030008400	S.RES ERJ2GEJ 182 X (1.8K)	B	66.7/124.4
R2605	7030005120	S.RES ERJ2GEJ 102 X (1K)	B	65.6/126.0
R2607	7030010040	S.RES ERJ2GEJ-JPW	T	40.5/132.2
R2608	7030009320	S.RES ERJ2GEJ 4R7 X (4.7)	B	83.9/132.8
R2611	7030005050	S.RES ERJ2GEJ 103 X (10K)	B	34.0/124.8
R2612	7030005090	S.RES ERJ2GEJ 104 X (100K)	B	38.5/125.4
R2613	7030005080	S.RES ERJ2GEJ 823 X (82K)	B	38.5/123.6
R2614	7030005120	S.RES ERJ2GEJ 102 X (1K)	B	34.7/126.6
R2617	7030005040	S.RES ERJ2GEJ 472 X (4.7K)	T	63.4/111.1
R2618	7030007340	S.RES ERJ2GEJ 153 X (15K)	T	69.4/112.7
R2619	7030005060	S.RES ERJ2GEJ 333 X (33K)	T	63.4/112.2
R2620	7030005120	S.RES ERJ2GEJ 102 X (1K)	T	78.1/100.3
R2621	7030005120	S.RES ERJ2GEJ 102 X (1K)	T	78.1/99.4
R2623	7030005240	S.RES ERJ2GEJ 473 X (47K)	T	9.9/112.9
R2624	7030004970	S.RES ERJ2GEJ 470 X (47K)	B	86.9/122.0
R2628	7030005240	S.RES ERJ2GEJ 473 X (47K)	B	61.9/121.8
C5	4030017460	S.CER C1005 JB 1H 102K-T	B	47.5/30.8
C6	4030018960	S.CER C3216 JB 1C 106MT-N	T	66.3/12.0
C7	4030017330	S.CER C1005 JF 1C 104Z-T	T	73.1/12.2
C8	4030017330	S.CER C1005 JF 1C 104Z-T	T	77.3/9.1
C9	4030017330	S.CER C1005 JF 1C 104Z-T	T	73.1/14.0
C10	4030017330	S.CER C1005 JF 1C 104Z-T	T	74.8/14.9
C11	4030017330	S.CER C1005 JF 1C 104Z-T	T	73.1/17.6
C12	4030017330	S.CER C1005 JF 1C 104Z-T	T	76.4/16.7
C13	4030017330	S.CER C1005 JF 1C 104Z-T	T	72.6/16.7
C14	4030017460	S.CER C1005 JB 1H 102K-T	T	67.7/16.6
C15	4030017460	S.CER C1005 JB 1H 102K-T	T	63.7/14.8
C16	4030017460	S.CER C1005 JB 1H 102K-T	T	62.7/15.7
C17	4030017460	S.CER C1005 JB 1H 102K-T	T	63.3/18.8
C18	4030017620	S.CER C1005 CH 1H 100C-T	T	60.7/18.9
C21	4030017730	S.CER C1005 JB 1H 471K-T	T	64.5/13.9
C25	4030017580	S.CER C1005 CH 1H 060C-T	T	55.2/17.9
C26	4030017660	S.CER C1005 CH 1H 330J-T	T	55.2/18.8
C27	4030017780	S.CER C1005 JB 1H 472K-T	T	51.7/20.5
C28	4030017530	S.CER C1005 CH 1H 0R5B-T	T	53.8/17.2
C29	4030017590	S.CER C1005 CH 1H 070C-T	T	51.7/19.6
C30	4030017730	S.CER C1005 JB 1H 471K-T	T	45.9/17.5
C31	4030017530	S.CER C1005 CH 1H 0R5B-T	T	53.8/16.3
C32	4030017660	S.CER C1005 CH 1H 330J-T	T	52.1/17.4
C33	4030017580	S.CER C1005 CH 1H 060C-T	T	52.2/16.5
C34	4030017380	S.CER C1005 CH 1H 050B-T	T	56.0/15.0
C35	4030017380	S.CER C1005 CH 1H 050B-T	T	56.0/12.5
C36	4030017730	S.CER C1005 JB 1H 471K-T	T	51.0/15.7
C37	4030017780	S.CER C1005 JB 1H 472K-T	T	70.4/11.4
C38	4030017780	S.CER C1005 JB 1H 472K-T	T	45.9/18.4
C40	4030017730	S.CER C1005 JB 1H 471K-T	T	73.1/13.1
C41	4030017730	S.CER C1005 JB 1H 471K-T	T	66.9/19.7
C42	4030017730	S.CER C1005 JB 1H 471K-T	T	70.4/12.3
C43	4030017420	S.CER C1005 CH 1H 470J-T	T	45.9/16.6
C44	4030017420	S.CER C1005 CH 1H 470J-T	T	48.0/11.7
C50	4030017640	S.CER C1005 CH 1H 150J-T	B	80.5/13.6
C51	4030017640	S.CER C1005 CH 1H 150J-T	B	79.9/11.8
C52	4030017430	S.CER C1005 CH 1H 101J-T	B	79.9/12.7
C53	4030016930	S.CER C1005 JB 1A 104K-T	B	79.7/22.0
C54	4030016930	S.CER C1005 JB 1A 104K-T	T	79.8/12.9
C55	4030016930	S.CER C1005 JB 1A 104K-T	T	78.1/17.9
C56	4030018860	S.CER C1005 JB 0J 105K-T	B	65.6/22.7
C58	4030017710	S.CER C1005 CH 1H 181J-T	T	72.2/19.4
C59	4030017710	S.CER C1005 CH 1H 181J-T	T	65.5/23.7
C101	4030017330	S.CER C1005 JF 1C 104Z-T	T	10.3/15.5
C102	4030017330	S.CER C1005 JF 1C 104Z-T	T	13.2/16.9
C103	4030017330	S.CER C1005 JF 1C 104Z-T	T	13.2/17.8
C104	4030017330	S.CER C1005 JF 1C 104Z-T	T	3.3/29.9
C105	4030017330	S.CER C1005 JF 1C 104Z-T	T	13.2/19.6
C106	4030017850	S.CER C2012 CH 1H 272J-T	T	28.8/11.0
C107	4030017330	S.CER C1005 JF 1C 104Z-T	T	19.2/12.9
C108	4030017330	S.CER C1005 JF 1C 104Z-T	T	36.5/16.6
C109	4030017330	S.CER C1005 JF 1C 104Z-T	T	25.2/14.0
C110	4030017800	S.CER C1608 CH 1H 561J-T	T	27.9/7.8
C111	4030018590	S.CER C1608 CH 1H 122J-T	T	29.2/5.0
C112	4030017330	S.CER C1005 JF 1C 104Z-T	T	23.9/5.3
C114	4030018600	S.CER C1608 CH 1H 152J-T	T	25.2/15.1
C115	4030008490	S.CER C2012 JB 1H 682K-T	T	24.8/16.7
C116	4030017850	S.CER C2012 CH 1H 272J-T	T	24.8/18.5
C117	4030017330	S.CER C1005 JF 1C 104Z-T	T	19.9/7.1
C118	4030017330	S.CER C1005 JF 1C 104Z-T	T	38.3/17.6
C119	4030017780	S.CER C1005 JB 1H 472K-T	T	7.8/22.2
C120	4030017330	S.CER C1005 JF 1C 104Z-T	T	7.8/21.3
C121	4030017330	S.CER C1005 JF 1C 104Z-T	T	5.7/12.9
C122	4030017330	S.CER C1005 JF 1C 104Z-T	T	13.2/18.7
C123	4030017330	S.CER C1005 JF 1C 104Z-T	T	15.4/14.4
C124	4030017330	S.CER C1005 JF 1C 104Z-T	T	16.4/15.3
C125	4030017460	S.CER C1005 JB 1H 102K-T	T	40.0/21.8
C126	4030017460	S.CER C1005 JB 1H 102K-T	T	37.1/22.4

Eqv.= This component is equivalent to the REF No. component listed above, and may be substituted on parts orders and repairs.

[MAIN UNIT]

REF NO.	PARTS NO.	DESCRIPTION	M.	H/V LOCATION
C127	4030017460	S.CER C1005 JB 1H 102K-T	B	19.2/23.1
C208	4030017330	S.CER C1005 JF 1C 104Z-T	T	19.8/31.2
C209	4030017680	S.CER C1005 CH 1H 820J-T	T	18.5/41.4
C210	4030017610	S.CER C1005 CH 1H 090C-T	T	18.5/40.5
C211	4030017700	S.CER C1005 CH 1H 151J-T	T	18.5/42.3
C212	4030017650	S.CER C1005 CH 1H 270J-T	T	23.3/39.2
C213	4030017510	S.CER C1005 CH 1H 680J-T	T	21.8/43.0
C214	4030018820	S.CER C1005 JB 1H 561K-T	T	31.7/54.4
C215	4030017440	S.CER C1005 CH 1H 221J-T	T	37.0/54.6
C226	4030017330	S.CER C1005 JF 1C 104Z-T	T	24.1/43.4
C227	4030017330	S.CER C1005 JF 1C 104Z-T	T	19.8/30.3
C228	4030017430	S.CER C1005 CH 1H 101J-T	T	28.2/39.2
C229	4030017440	S.CER C1005 CH 1H 221J-T	T	29.8/39.2
C237	4030017500	S.CER C1005 CH 1H 560J-T	T	28.2/38.2
C238	4030017330	S.CER C1005 JF 1C 104Z-T	T	21.9/30.9
C239	4030017330	S.CER C1005 JF 1C 104Z-T	B	24.7/41.5
C240	4030017400	S.CER C1005 CH 1H 220J-T	B	28.2/43.7
C241	4030017580	S.CER C1005 CH 1H 060C-T	B	31.6/40.1
C242	4030017680	S.CER C1005 CH 1H 820J-T	B	31.6/41.0
C243	4030018630	S.CER C2012 CH 1H 472J-T	T	32.5/57.8
C244	4030018680	S.CER C2012 CH 1H 822J-T	T	36.8/57.8
C245	4030017330	S.CER C1005 JF 1C 104Z-T	T	45.8/63.2
C246	4030018600	S.CER C1608 CH 1H 152J-T	T	36.5/56.1
C247	4030017860	S.CER C2012 CH 1H 332J-T	T	40.3/54.1
C248	4030018630	S.CER C2012 CH 1H 472J-T	T	43.8/57.9
C249	4030017330	S.CER C1005 JF 1C 104Z-T	B	24.9/56.5
C250	4030017330	S.CER C1005 JF 1C 104Z-T	B	24.9/53.4
C251	4030018590	S.CER C1608 CH 1H 122J-T	T	30.6/51.0
C252	4030011340	S.CER C1608 CH 1H 471J-T	T	32.0/48.6
C253	4030018630	S.CER C2012 CH 1H 472J-T	T	29.1/53.3
C254	4030018620	S.CER C1608 CH 1H 222J-T	T	38.1/50.8
C255	4030018580	S.CER C1608 CH 1H 821J-T	T	32.6/55.9
C256	4030010760	S.CER C1608 CH 1H 331J-T	T	38.1/52.1
C257	4030018610	S.CER C1608 CH 1H 182J-T	T	34.4/53.4
C258	4030017870	S.CER C1608 CH 1H 681J-T	T	40.7/52.3
C259	4030018590	S.CER C1608 CH 1H 122J-T	T	37.1/53.4
C260	4030017870	S.CER C1608 CH 1H 681J-T	T	40.7/47.9
C261	4030017780	S.CER C1005 JB 1H 472K-T	B	38.0/56.3
C262	4030017780	S.CER C1005 JB 1H 472K-T	B	38.0/53.8
C263	4030017330	S.CER C1005 JF 1C 104Z-T	B	24.6/50.3
C264	4030017330	S.CER C1005 JF 1C 104Z-T	B	23.9/47.2
C265	4030011280	S.CER C1608 CH 1H 271J-T	B	36.4/44.0
C266	4030017700	S.CER C1005 CH 1H 151J-T	B	31.0/46.1
C267	4030018590	S.CER C1608 CH 1H 122J-T	B	36.4/49.6
C268	4030018580	S.CER C1608 CH 1H 821J-T	B	31.8/43.0
C269	4030017710	S.CER C1005 CH 1H 181J-T	B	36.5/47.2
C270	4030017430	S.CER C1005 CH 1H 101J-T	B	32.7/44.1
C271	4030011330	S.CER C1608 CH 1H 391J-T	B	36.4/48.3
C272	4030011280	S.CER C1608 CH 1H 271J-T	B	36.4/43.9
C273	4030011330	S.CER C1608 CH 1H 391J-T	B	38.8/47.3
C274	4030017730	S.CER C1005 JB 1H 471K-T	B	34.3/43.7
C275	4030017780	S.CER C1005 JB 1H 472K-T	B	43.0/49.7
C276	4030017780	S.CER C1005 JB 1H 472K-T	B	39.3/46.3
C278	4030017330	S.CER C1005 JF 1C 104Z-T	T	30.9/31.9
C279	4030017330	S.CER C1005 JF 1C 104Z-T	T	31.0/43.9
C281	4030017330	S.CER C1005 JF 1C 104Z-T	T	33.0/31.7
C282	4030017650	S.CER C1005 CH 1H 270J-T	B	31.6/39.2
C283	4030017330	S.CER C1005 JF 1C 104Z-T	B	35.9/35.9
C284	4030017780	S.CER C1005 JB 1H 472K-T	B	42.7/43.3
C285	4030017380	S.CER C1005 CH 1H 050B-T	B	33.2/39.5
C286	4030017510	S.CER C1005 CH 1H 680J-T	B	34.8/39.5
C287	4030017690	S.CER C1005 CH 1H 121J-T	B	36.6/37.9
C288	4030017680	S.CER C1005 CH 1H 820J-T	B	34.3/36.3
C289	4030017420	S.CER C1005 CH 1H 470J-T	B	36.4/36.8
C290	4030018600	S.CER C1608 CH 1H 152J-T	B	38.8/37.6
C291	4030017680	S.CER C1005 CH 1H 820J-T	B	38.0/36.6
C292	4030017330	S.CER C1005 JF 1C 104Z-T	T	30.9/30.1
C293	4030017780	S.CER C1005 JB 1H 472K-T	T	38.2/34.9
C294	4030017440	S.CER C1005 CH 1H 221J-T	B	38.6/49.7
C295	4030017510	S.CER C1005 CH 1H 680J-T	T	40.4/51.2
C301	4030017330	S.CER C1005 JF 1C 104Z-T	T	47.1/30.1
C302	40			

[MAIN UNIT]

REF NO.	PARTS NO.	DESCRIPTION	M.	H/V LOCATION
C431	4030017330	S.CER C1005 JF 1C 104Z-T	T	88.6/26.7
C432	4030017780	S.CER C1005 JB 1H 472K-T	B	88.6/19.3
C433	4030017780	S.CER C1005 JB 1H 472K-T	T	88.9/20.3
C434	4030017780	S.CER C1005 JB 1H 472K-T	T	86.8/23.0
C511	4030017460	S.CER C1005 JB 1H 102K-T	T	41.9/26.8
C512	4030017780	S.CER C1005 JB 1H 472K-T	T	93.6/33.5
C513	4030017330	S.CER C1005 JF 1C 104Z-T	T	88.5/28.3
C514	4030017330	S.CER C1005 JF 1C 104Z-T	B	88.3/31.7
C515	4030017780	S.CER C1005 JB 1H 472K-T	T	81.8/33.2
C516	4030017580	S.CER C1005 CH 1H 060C-T	T	86.1/38.7
C518	4030017570	S.CER C1005 CH 1H 040B-T	T	86.9/36.5
C525	4030017330	S.CER C1005 JF 1C 104Z-T	T	81.8/32.3
C526	4030016790	S.CER C1005 JB 1E 103K-T	T	78.0/38.3
C527	4030017330	S.CER C1005 JF 1C 104Z-T	T	79.6/38.0
C528	4030017330	S.CER C1005 JF 1C 104Z-T	T	89.7/35.2
C529	4030017670	S.CER C1005 CH 1H 390J-T	T	91.3/33.8
C530	4030017460	S.CER C1005 JB 1H 102K-T	B	87.7/34.2
C602	4030017570	S.CER C1005 CH 1H 040B-T	B	85.7/39.7
C603	4030017780	S.CER C1005 JB 1H 472K-T	T	89.2/40.1
C604	4030017780	S.CER C1005 JB 1H 472K-T	T	94.1/46.5
C605	4030017620	S.CER C1005 CH 1H 100C-T	T	86.0/44.2
C606	4030017620	S.CER C1005 CH 1H 100C-T	B	85.7/41.5
C608	4030017550	S.CER C1005 CH 1H 1R5B-T	B	82.6/43.9
C609	4030017580	S.CER C1005 CH 1H 060C-T	B	78.7/46.8
C610	4030017620	S.CER C1005 CH 1H 100C-T	B	82.6/44.8
C611	4030017780	S.CER C1005 JB 1H 472K-T	B	85.2/37.6
C612	4030017610	S.CER C1005 CH 1H 090C-T	T	79.5/40.5
C613	4030017620	S.CER C1005 CH 1H 100C-T	T	76.6/43.8
C614	4030017780	S.CER C1005 JB 1H 472K-T	T	69.7/38.9
C615	4030017780	S.CER C1005 JB 1H 472K-T	T	64.3/43.1
C616	4030017780	S.CER C1005 JB 1H 472K-T	T	77.4/39.5
C617	4030017620	S.CER C1005 CH 1H 100C-T	B	85.7/40.6
C618	4030017620	S.CER C1005 CH 1H 100C-T	B	81.0/44.8
C701	4030017330	S.CER C1005 JF 1C 104Z-T	T	59.0/50.7
C702	4030017330	S.CER C1005 JF 1C 104Z-T	T	63.0/45.1
C703	4510008630	S.ELE 16 CE 47 FE	B	59.0/45.0
C704	4030017780	S.CER C1005 JB 1H 472K-T	T	58.7/43.0
C705	4030017600	S.CER C1005 CH 1H 080C-T	T	59.6/45.1
C707	4030017330	S.CER C1005 JF 1C 104Z-T	T	64.3/53.0
C708	4030017460	S.CER C1005 JB 1H 102K-T	T	64.6/55.1
C709	4030017780	S.CER C1005 JB 1H 472K-T	T	60.7/58.7
C710	4030017780	S.CER C1005 JB 1H 472K-T	T	62.3/58.6
C711	4030017460	S.CER C1005 JB 1H 102K-T	T	57.2/50.7
C712	4030017600	S.CER C1005 CH 1H 080C-T	T	52.4/50.3
C714	4030017460	S.CER C1005 JB 1H 102K-T	T	56.2/49.8
C715	4030017780	S.CER C1005 JB 1H 472K-T	T	52.2/53.3
C716	4030017340	S.CER C1005 CH 1H 010B-T	T	55.4/55.2
C717	4030017780	S.CER C1005 JB 1H 472K-T	T	51.2/52.4
C718	4030017780	S.CER C1005 JB 1H 472K-T	T	57.0/55.2
C719	4030017340	S.CER C1005 CH 1H 010B-T	T	61.2/53.9
C720	4030017380	S.CER C1005 CH 1H 050B-T	T	59.4/42.1
C721	4030017780	S.CER C1005 JB 1H 472K-T	T	51.2/49.7
C801	4030017330	S.CER C1005 JF 1C 104Z-T	T	71.5/64.1
C803	4030017780	S.CER C1005 JB 1H 472K-T	T	65.3/61.8
C804	4030017330	S.CER C1005 JF 1C 104Z-T	T	92.0/58.1
C805	4030017460	S.CER C1005 JB 1H 102K-T	T	83.5/55.8
C807	4030017330	S.CER C1005 JF 1C 104Z-T	T	60.6/66.7
C808	4030017870	S.CER C1608 CH 1H 681J-T	T	60.4/65.5
C809	4030018630	S.CER C2012 CH 1H 472J-T	T	57.5/66.8
C810	4030017700	S.CER C1005 CH 1H 151J-T	T	63.9/68.5
C811	4030017700	S.CER C1005 CH 1H 151J-T	T	63.9/69.4
C812	4030017700	S.CER C1005 CH 1H 151J-T	T	60.1/69.4
C813	4030017700	S.CER C1005 CH 1H 151J-T	T	60.1/68.5
C814	4030017330	S.CER C1005 JF 1C 104Z-T	T	88.6/57.2
C815	4030017460	S.CER C1005 JB 1H 102K-T	T	86.7/60.6
C816	4030017400	S.CER C1005 CH 1H 220J-T	T	85.8/59.7
C817	4030017400	S.CER C1005 CH 1H 220J-T	T	84.1/61.8
C818	4030018590	S.CER C1608 CH 1H 122J-T	T	54.6/65.7
C819	4030017850	S.CER C2012 CH 1H 272J-T	T	51.7/65.9
C901	4030017330	S.CER C1005 JF 1C 104Z-T	T	38.4/71.3
C910	4030017710	S.CER C1005 CH 1H 181J-T	T	39.3/65.7
C911	4030017700	S.CER C1005 CH 1H 151J-T	T	48.0/74.8
C913	4030017330	S.CER C1005 JF 1C 104Z-T	T	38.3/61.1
C914	4030017330	S.CER C1005 JF 1C 104Z-T	T	39.3/63.6
C916	4030017330	S.CER C1005 JF 1C 104Z-T	T	34.0/62.0
C917	4030017780	S.CER C1005 JB 1H 472K-T	T	35.7/63.3
C918	4030017330	S.CER C1005 JF 1C 104Z-T	T	34.3/67.5
C920	4030017460	S.CER C1005 JB 1H 102K-T	T	38.4/74.2
C921	4030017330	S.CER C1005 JF 1C 104Z-T	T	34.3/70.2
C922	4030017330	S.CER C1005 JF 1C 104Z-T	T	29.4/73.1
C923	4030017330	S.CER C1005 JF 1C 104Z-T	T	29.9/72.2
C924	4030017780	S.CER C1005 JB 1H 472K-T	T	41.2/74.2
C925	4030017700	S.CER C1005 CH 1H 151J-T	B	31.5/73.0
C1001	4030017780	S.CER C1005 JB 1H 472K-T	T	31.8/71.2
C1009	4030017780	S.CER C1005 JB 1H 472K-T	T	25.9/72.0
C1016	4030017330	S.CER C1005 JF 1C 104Z-T	T	25.9/73.8
C1018	4030017460	S.CER C1005 JB 1H 102K-T	T	20.3/76.0
C1019	4030017330	S.CER C1005 JF 1C 104Z-T	T	15.3/75.8
C1020	4030017330	S.CER C1005 JF 1C 104Z-T	T	12.7/75.8
C1021	4030017330	S.CER C1005 JF 1C 104Z-T	T	4.6/79.0
C1022	4510008630	S.ELE 16 CE 47 FE	B	6.1/86.0
C1023	4510008630	S.ELE 16 CE 47 FE	B	5.7/77.4
C1101	4030017490	S.CER C1608 JB 1A 105K-T	T	2.5/79.0
C1102	4030017330	S.CER C1005 JF 1C 104Z-T	T	4.6/78.1
C1104	4030017490	S.CER C1608 JB 1A 105K-T	T	2.5/87.8
C1105	4030018960	S.CER C3216 JB 1C 106MT-N	T	3.0/89.7
C1108	4030017330	S.CER C1005 JF 1C 104Z-T	T	2.4/91.3
C1201	4030017330	S.CER C1005 JF 1C 104Z-T	T	26.7/80.6
C1202	4030017330	S.CER C1005 JF 1C 104Z-T	T	28.7/80.5
C1203	4030017330	S.CER C1005 JF 1C 104Z-T	T	18.6/79.2
C1204	4030018960	S.CER C3216 JB 1C 106MT-N	T	9.1/77.0
C1206	4030017780	S.CER C1005 JB 1H 472K-T	T	14.3/79.4
C1207	4030017780	S.CER C1005 JB 1H 472K-T	T	12.7/78.5
C1208	4030018080	S.CER C1005 JB 1H 182K-T	T	13.0/85.0
C1209	4030018820	S.CER C1005 JB 1H 561K-T	T	13.0/84.1

Eqv.= This component is equivalent to the REF No. component listed above, and may be substituted on parts orders and repairs.

[MAIN UNIT]

REF NO.	PARTS NO.	DESCRIPTION	M.	H/V LOCATION
C1210	4030017780	S.CER C1005 JB 1H 472K-T	T	11.4/84.1
C1211	4030017490	S.CER C1608 JB 1A 105K-T	T	9.2/84.5
C1212	4030017490	S.CER C1608 JB 1A 105K-T	T	6.8/87.8
C1213	4030017330	S.CER C1005 JF 1C 104Z-T	T	21.9/78.3
C1301	4030017330	S.CER C1005 JF 1C 104Z-T	T	15.3/73.6
C1302	4030017330	S.CER C1005 JF 1C 104Z-T	T	15.1/67.4
C1303	4030018860	S.CER C1005 JB 0J 105K-T	T	11.4/67.4
C1304	4030017330	S.CER C1005 JF 1C 104Z-T	T	14.4/69.2
C1305	4030017330	S.CER C1005 JF 1C 104Z-T	T	11.6/65.6
C1306	4030017330	S.CER C1005 JF 1C 104Z-T	T	10.9/60.3
C1307	4030017330	S.CER C1005 JF 1C 104Z-T	T	16.2/65.6
C1308	4030017330	S.CER C1005 JF 1C 104Z-T	T	14.5/60.3
C1309	4030017330	S.CER C1005 JF 1C 104Z-T	T	3.8/50.8
C1310	4030017330	S.CER C1005 JF 1C 104Z-T	T	16.2/62.9
C1311	4030018960	S.CER C3216 JB 1C 106MT-N	T	5.4/58.5
C1312	4030018860	S.CER C1005 JB 0J 105K-T	T	13.0/66.5
C1401	4030017330	S.CER C1005 JF 1C 104Z-T	B	46.6/77.4
C1402	4030017700	S.CER C1005 CH 1H 151J-T	B	42.0/69.7
C1403	4030017650	S.CER C1005 CH 1H 472J-T	B	45.5/71.5
C1404	4030017700	S.CER C1005 CH 1H 151J-T	B	42.0/70.6
C1405	4030017780	S.CER C1005 JB 1H 472K-T	B	43.7/71.5
C1406	4030017780	S.CER C1005 JB 1H 472K-T	B	42.0/72.4
C1407	4030017780	S.CER C1005 JB 1H 472K-T	B	44.7/74.4
C1408	4030017780	S.CER C1005 JB 1H 472K-T	B	40.4/79.1
C1409	4030017780	S.CER C1005 JB 1H 472K-T	B	34.7/79.1
C1411	4030018860	S.CER C1005 JB 0J 105K-T	B	27.0/80.0
C1412	4030016950	S.CER C1005 JB 1A 473K-T	B	27.1/80.9
C1413	4030017490	S.CER C1608 JB 1A 105K-T	B	20.7/77.5
C1414	4030016950	S.CER C1005 JB 1A 473K-T	B	25.1/77.8
C1415	4510008640	S.ELE 6 CE 100 FE	B	13.2/81.2
C1416	4030016950	S.CER C1005 JB 1A 473K-T	B	20.2/78.5
C1418	4030017350	S.CER C1005 CH 1H 020B-T	B	23.1/86.6
C1419	4030018390	S.CER C1005 JB 1A 563K-T	B	23.1/87.5
C1420	4030017420	S.CER C1005 CH 1H 470J-T	B	17.9/83.1
C1421	4030018960	S.CER C3216 JB 1C 106MT-N	B	19.8/87.3
C1422	4030017640	S.CER C1005 CH 1H 150J-T	B	17.9/82.2
C1423	4610001970	S.TRI TZC3P200A110R00 (TZC03P200A1102)	T	3.9/72.6
C1491	4030017670	S.CER C1005 CH 1H 390J-T	[EUR] B	88.2/29.4
	4030017670	S.CER C1005 CH 1H 390J-T	[FRA]	
	4030017670	S.CER C1005 CH 1H 390J-T	[ESP]	
	4030017400	S.CER C1005 CH 1H 220J-T	[USA]	
	4030017670	S.CER C1005 CH 1H 390J-T	[ITR]	
	4030017670	S.CER C1005 CH 1H 390J-T	[UK]	
	4030017400	S.CER C1005 CH 1H 220J-T	[KOR]	
	4030017670	S.CER C1005 CH 1H 390J-T	[AUS]	
	4030017670	S.CER C1005 CH 1H 390J-T	[CHN]	
C1493	4030017670	S.CER C1005 CH 1H 390J-T	B	86.1/33.8
C1494	4030017670	S.CER C1005 CH 1H 390J-T	[EUR] B	83.7/34.0
	4030017670	S.CER C1005 CH 1H 390J-T	[FRA]	
	4030017670	S.CER C1005 CH 1H 390J-T	[ESP]	
	4030017670	S.CER C1005 CH 1H 390J-T	[USA]	
	4030017420	S.CER C1005 CH 1H 470J-T	[KOR]	
	4030017670	S.CER C1005 CH 1H 390J-T	[AUS]	
	4030017670	S.CER C1005 CH 1H 390J-T	[CHN]	
C1495	4030011280	S.CER C1608 CH 1H 271J-T	B	84.0/33.0
	4030011280	S.CER C1608 CH 1H 271J-T	[FRA]	
	4030011280	S.CER C1608 CH 1H 271J-T	[ESP]	
	4030010760	S.CER C1608 CH 1H 331J-T	[USA]	
	4030011280	S.CER C1608 CH 1H 271J-T	[ITR]	
	4030011280	S.CER C1608 CH 1H 271J-T	[UK]	
	4030010760	S.CER C1608 CH 1H 331J-T	[KOR]	
	4030011280	S.CER C1608 CH 1H 271J-T	[AUS]	
	4030011280	S.CER C1608 CH 1H 271J-T	[CHN]	
C1496	4030017660	S.CER C1005 CH 1H 330J-T	B	79.3/35.3
C1498	4030017670	S.CER C1005 CH 1H 390J-T	[EUR] B	79.4/36.2
	4030017670	S.CER C1005 CH 1H 390J-T	[FRA]	
	4030017670	S.CER C1005 CH 1H 390J-T	[ESP]	
	4030017400	S.CER C1005 CH 1H 220J-T	[USA]	
	4030017670	S.CER C1005 CH 1H 390J-T	[ITR]	
	4030017670	S.CER C1005 CH 1H 390J-T	[UK]	
	4030017400	S.CER C1005 CH 1H 220J-T	[KOR]	
	4030017670	S.CER C1005 CH 1H 390J-T	[AUS]	
	4030017670	S.CER C1005 CH 1H 3		

[MAIN UNIT]

REF NO.	PARTS NO.	DESCRIPTION	M.	H/V LOCATION
C1524	4030017420	S.CER C1005 CH 1H 470J-T	[EUR]	B 73.7/60.6
	4030017420	S.CER C1005 CH 1H 470J-T	[FRA]	
	4030017420	S.CER C1005 CH 1H 470J-T	[ESP]	
	4030017510	S.CER C1005 CH 1H 680J-T	[USA]	
	4030017420	S.CER C1005 CH 1H 470J-T	[ITR]	
	4030017420	S.CER C1005 CH 1H 470J-T	[UK]	
	4030017510	S.CER C1005 CH 1H 680J-T	[KOR]	
	4030017420	S.CER C1005 CH 1H 470J-T	[AUS]	
	4030017420	S.CER C1005 CH 1H 470J-T	[CHN]	
C1525	4030018900	S.CER C1005 JB 0J 474K-T	B	85.9/60.0
C1526	4030018960	S.CER C3216 JB 1C 106MT-N	B	69.3/51.6
C1531	4030017490	S.CER C1608 JB 1A 105K-T	B	83.3/51.6
C1532	4030017780	S.CER C1005 JB 1H 472K-T	B	81.9/41.3
C1533	4030017780	S.CER C1005 JB 1H 472K-T	B	81.9/39.5
C1534	4030017780	S.CER C1005 JB 1H 472K-T	B	83.6/38.5
C1601	4030017780	S.CER C1005 JB 1H 472K-T	T	6.3/52.3
C1604	4030017780	S.CER C1005 JB 1H 472K-T	T	5.6/50.8
C1605	4030017330	S.CER C1005 JF 1C 104Z-T	T	8.8/48.7
C1607	4030017780	S.CER C1005 JB 1H 472K-T	T	14.8/46.0
C1609	4030017490	S.CER C1608 JB 1A 105K-T	T	14.1/33.7
C1610	4030017330	S.CER C1005 JF 1C 104Z-T	T	12.1/44.8
C1611	4030017330	S.CER C1005 JF 1C 104Z-T	T	14.6/41.1
C1613	4030017330	S.CER C1005 JF 1C 104Z-T	T	19.0/47.1
C1614	4030017730	S.CER C1005 JB 1H 471K-T	T	15.1/36.2
C1615	4030017420	S.CER C1005 CH 1H 470J-T	T	10.4/46.9
C1616	4550007260	S.TAN F931C475MAABMA	T	9.7/50.6
C1618	4030017430	S.CER C1005 CH 1H 101J-T	T	12.7/26.3
C1701	4030017490	S.CER C1608 JB 1A 105K-T	B	55.1/50.5
C1702	4030017490	S.CER C1608 JB 1A 105K-T	B	55.0/69.7
C1801	4030017330	S.CER C1005 JF 1C 104Z-T	B	18.4/105.0
C1802	4510008630	S.ELE 16 CE 47 FE	B	14.5/101.3
C1803	4030018960	S.CER C3216 JB 1C 106MT-N	B	22.3/112.2
C1804	4030017330	S.CER C1005 JF 1C 104Z-T	B	22.9/110.6
C1901	4030017330	S.CER C1005 JF 1C 104Z-T	T	36.2/80.4
C1902	4030017330	S.CER C1005 JF 1C 104Z-T	T	33.7/80.4
C1903	4030017330	S.CER C1005 JF 1C 104Z-T	B	23.3/18.9
C1904	4030017330	S.CER C1005 JF 1C 104Z-T	B	32.5/89.9
C1905	4030017330	S.CER C1005 JF 1C 104Z-T	B	26.0/33.8
C1906	4030017330	S.CER C1005 JF 1C 104Z-T	B	26.0/32.9
C1907	4030017330	S.CER C1005 JF 1C 104Z-T	T	41.7/80.4
C1908	4030017330	S.CER C1005 JF 1C 104Z-T	T	38.5/80.7
C1909	4030017330	S.CER C1005 JF 1C 104Z-T	B	21.7/14.0
C1910	4030017460	S.CER C1005 JB 1H 102K-T	B	45.4/25.5
C1916	4030018960	S.CER C3216 JB 1C 106MT-N	B	14.8/50.6
C1917	4030018960	S.CER C3216 JB 1C 106MT-N	B	5.4/52.8
C1951	4030018960	S.CER C3216 JB 1C 106MT-N	B	48.1/103.1
C1952	4030018960	S.CER C3216 JB 1C 106MT-N	B	48.1/98.9
C1953	4030018960	S.CER C3216 JB 1C 106MT-N	B	48.1/96.8
C1954	4030018960	S.CER C3216 JB 1C 106MT-N	B	48.7/105.2
C1955	4030018960	S.CER C3216 JB 1C 106MT-N	B	48.1/101.0
C1956	4030018960	S.CER C3216 JB 1C 106MT-N	B	60.9/118.7
C1957	4030017330	S.CER C1005 JF 1C 104Z-T	B	63.8/116.7
C1958	4030018910	S.CER C1608 JB 0J 475K-T	B	20.9/125.7
C1959	4550008160	S.TAN F931A226MAA	[EUR]	B 11.7/120.2
	4550007090	S.TAN TEESVA 1A 226M8R	[EUR]	
	4550007090	S.TAN TEESVA 1A 226M8R	[FRA]	
	4550008160	S.TAN F931A226MAA	[FRA]	
C1959	4550007090	S.TAN TEESVA 1A 226M8R	[ESP]	B 11.7/120.2
	4550008160	S.TAN F931A226MAA	[ESP]	
C1959	4550008160	S.TAN F931A226MAA	[USA]	B 11.7/120.2
	4550007090	S.TAN TEESVA 1A 226M8R	[USA]	
C1959	4550007090	S.TAN TEESVA 1A 226M8R	[ITR]	B 11.7/120.2
	4550008160	S.TAN F931A226MAA	[ITR]	
C1959	4550008160	S.TAN F931A226MAA	[UK]	B 11.7/120.2
	4550007090	S.TAN TEESVA 1A 226M8R	[UK]	
C1959	4550007090	S.TAN TEESVA 1A 226M8R	[KOR]	B 11.7/120.2
	4550008160	S.TAN F931A226MAA	[KOR]	
C1959	4550007090	S.TAN TEESVA 1A 226M8R	[AUS]	B 11.7/120.2
	4550008160	S.TAN F931A226MAA	[AUS]	
C1959	4550008160	S.TAN F931A226MAA	[CHN]	B 11.7/120.2
	4550007090	S.TAN TEESVA 1A 226M8R	[CHN]	
C1960	4030010210	S.CER C3216 JB 1C 105M-T	B	47.3/109.8
C1961	4030017730	S.CER C1005 JB 1H 471K-T	B	44.1/110.1
C1962	4030017440	S.CER C1005 CH 1H 221J-T	B	44.7/108.4
C1963	4030017500	S.CER C1005 CH 1H 560J-T	B	35.3/105.2
C1964	4030017330	S.CER C1005 JF 1C 104Z-T	B	44.3/111.4
C1965	4030018960	S.CER C3216 JB 1C 106MT-N	B	7.5/108.1
C1966	4030017330	S.CER C1005 JF 1C 104Z-T	B	10.2/103.1
C1968	4030018960	S.CER C3216 JB 1C 106MT-N	B	31.8/103.6
C1969	4030018970	S.CER C3225 JB 1C 226MT-N	B	30.9/101.0
C1970	4030018970	S.CER C3225 JB 1C 226MT-N	B	30.9/98.0
C1971	4030017330	S.CER C1005 JF 1C 104Z-T	B	45.9/111.4
C1972	4030017330	S.CER C1005 JF 1C 104Z-T	B	47.6/106.8
C1973	4030017330	S.CER C1005 JF 1C 104Z-T	B	32.1/105.2
C2001	4030017780	S.CER C1005 JB 1H 472K-T	T	33.3/10.4
C2002	4030017330	S.CER C1005 JF 1C 104Z-T	B	71.7/14.7
C2003	4030017780	S.CER C1005 JB 1H 472K-T	B	58.8/15.8
C2004	4030017780	S.CER C1005 JB 1H 472K-T	B	83.1/6.0
C2005	4030017780	S.CER C1005 JB 1H 472K-T	B	69.1/16.5
C2006	4030017330	S.CER C1005 JF 1C 104Z-T	B	83.1/6.9
C2007	4030017780	S.CER C1005 JB 1H 472K-T	B	84.7/6.0
C2008	4030017330	S.CER C1005 JF 1C 104Z-T	B	56.7/10.1
C2009	4030017330	S.CER C1005 JF 1C 104Z-T	B	75.4/18.7
C2010	4030017780	S.CER C1005 JB 1H 472K-T	B	75.7/6.7
C2011	4030017330	S.CER C1005 JF 1C 104Z-T	B	75.1/7.7
C2012	4030017780	S.CER C1005 JB 1H 472K-T	B	63.1/15.5
C2013	4030017330	S.CER C1005 JF 1C 104Z-T	B	89.0/2.0
C2014	4030017780	S.CER C1005 JB 1H 472K-T	B	32.5/11.9
C2015	4030017780	S.CER C1005 JB 1H 472K-T	B	32.5/12.8
C2016	4030017780	S.CER C1005 JB 1H 472K-T	B	19.1/131.2
C2017	4030017330	S.CER C1005 JF 1C 104Z-T	T	86.4/10.2
C2018	4030017780	S.CER C1005 JB 1H 472K-T	B	42.7/17.7
C2019	4030017780	S.CER C1005 JB 1H 472K-T	T	24.8/126.8
C2020	4030017330	S.CER C1005 JF 1C 104Z-T	B	84.2/23.1
C2021	4030017780	S.CER C1005 JB 1H 472K-T	B	32.5/16.1

Eqv.= This component is equivalent to the REF No. component listed above, and may be substituted on parts orders and repairs.

[MAIN UNIT]

REF NO.	PARTS NO.	DESCRIPTION	M.	H/V LOCATION
C2022	4030017780	S.CER C1005 JB 1H 472K-T	B	30.3/130.3
C2024	4030017780	S.CER C1005 JB 1H 472K-T	B	28.8/128.3
C2025	4030017780	S.CER C1005 JB 1H 472K-T	B	45.0/12.6
C2026	4030018960	S.CER C3216 JB 1C 106MT-N	B	10.2/23.5
C2027	4030018960	S.CER C3216 JB 1C 106MT-N	B	10.2/14.7
C2028	4030017330	S.CER C1005 JF 1C 104Z-T	B	51.8/12.7
C2029	4030017330	S.CER C1005 JF 1C 104Z-T	B	58.1/9.4
C2030	4030017330	S.CER C1005 JF 1C 104Z-T	B	55.9/15.8
C2032	4030017780	S.CER C1005 JB 1H 472K-T	B	27.4/129.0
C2033	4030017330	S.CER C1005 JF 1C 104Z-T	B	71.1/21.9
C2034	4030017780	S.CER C1005 JB 1H 472K-T	B	64.9/5.6
C2035	4030017780	S.CER C1005 JB 1H 472K-T	B	25.7/130.2
C2036	4030017330	S.CER C1005 JF 1C 104Z-T	B	88.2/8.0
C2037	4030017330	S.CER C1005 JF 1C 104Z-T	B	76.4/16.5
C2038	4030017780	S.CER C1005 JB 1H 472K-T	T	14.5/126.5
C2039	4030017780	S.CER C1005 JB 1H 472K-T	B	80.2/6.8
C2040	4030017780	S.CER C1005 JB 1H 472K-T	B	64.6/17.7
C2041	4030017330	S.CER C1005 JF 1C 104Z-T	B	75.2/10.5
C2042	4030017330	S.CER C1005 JF 1C 104Z-T	B	62.8/18.2
C2043	4030017780	S.CER C1005 JB 1H 472K-T	B	55.4/8.9
C2044	4030017780	S.CER C1005 JB 1H 472K-T	B	62.8/19.5
C2045	4030017780	S.CER C1005 JB 1H 472K-T	B	64.4/21.9
C2046	4030017780	S.CER C1005 JB 1H 472K-T	B	63.7/14.6
C2047	4030017780	S.CER C1005 JB 1H 472K-T	B	57.8/22.0
C2048	4030017780	S.CER C1005 JB 1H 472K-T	B	63.2/5.6
C2049	4030017780	S.CER C1005 JB 1H 472K-T	T	45.1/101.9
C2050	4030017780	S.CER C1005 JB 1H 472K-T	T	42.9/100.3
C2051	4030017330	S.CER C1005 JF 1C 104Z-T	T	56.3/100.0
C2052	4030017780	S.CER C1005 JB 1H 472K-T	T	21.6/108.1
C2053	4030017780	S.CER C1005 JB 1H 472K-T	T	49.9/107.6
C2054	4030018960	S.CER C3216 JB 1C 106MT-N	B	55.4/83.4
C2055	4030018960	S.CER C3216 JB 1C 106MT-N	B	28.2/88.6
C2058	4030018960	S.CER C3216 JB 1C 106MT-N	B	16.4/95.6
C2062	4550008170	S.TAN F931A476MBA	[EUR]	B 26.6/13.0
	4550007710	S.TAN TEESVB2 1A 476M8R	[EUR]	
C2062	4550007710	S.TAN TEESVB2 1A 476M8R	[FRA]	B 26.6/13.0
	4550008170	S.TAN F931A476MBA	[FRA]	
C2062	4550007710	S.TAN TEESVB2 1A 476M8R	[ESP]	B 26.6/13.0
	4550008170	S.TAN F931A476MBA	[ESP]	
C2062	4550008170	S.TAN F931A476MBA	[USA]	B 26.6/13.0
	4550007710	S.TAN TEESVB2 1A 476M8R	[USA]	
C2062	4550007710	S.TAN TEESVB2 1A 476M8R	[ITR]	B 26.6/13.0
	4550008170	S.TAN F931A476MBA	[ITR]	
C2062	4550008170	S.TAN F931A476MBA	[UK]	B 26.6/13.0
	4550007710	S.TAN TEESVB2 1A 476M8R	[UK]	
C2062	4550007710	S.TAN TEESVB2 1A 476M8R	[KOR]	B 26.6/13.0
	4550008170	S.TAN F931A476MBA	[KOR]	
C2062	4550007710	S.TAN TEESVB2 1A 476M8R	[AUS]	B 26.6/13.0
	4550008170	S.TAN F931A476MBA	[AUS]	
C2062	4550008170	S.TAN F931A476MBA	[CHN]	B 26.6/13.0
	4550007710	S.TAN TEESVB2 1A 476M8R	[CHN]	
C2063	4030017330	S.CER C1005 JB 1H 471K-T	B	46.1/13.8
C2064	4030018960	S.CER C3216 JB 1C 106MT-N	B	61.1/23.1
C2065	4030016930	S.CER C1005 JB 1A 104K-T	B	73.4/1.3
C2066	4030016930	S.CER C1005 JB 1A 104K-T	B	75.1/1.3
C2067	4030017430	S.CER C1005 CH 1		

[MAIN UNIT]

REF NO.	PARTS NO.	DESCRIPTION	M.	H/V LOCATION
C2233	4030017780	S.CER C1005 JB 1H 472K-T	T	4.7/123.3
C2234	4550007310	S.TAN F930J227MNMBA	T	70.1/130.6
C2235	4030018960	S.CER C3216 JB 1C 106MT-N	T	41.0/108.8
C2236	4030018960	S.CER C3216 JB 1C 106MT-N	T	39.9/111.2
C2237	4030017460	S.CER C1005 JB 1H 102K-T	T	60.6/123.4
C2254	4030017330	S.CER C1005 JF 1C 104Z-T	T	7.7/92.5
C2255	4030017330	S.CER C1005 JF 1C 104Z-T	B	2.5/98.2
C2256	4030017330	S.CER C1005 JF 1C 104Z-T	B	2.6/95.7
C2257	4030017330	S.CER C1005 JF 1C 104Z-T	T	9.9/88.0
C2260	4030017330	S.CER C1005 JF 1C 104Z-T	T	18.6/103.7
C2261	4030017330	S.CER C1005 JF 1C 104Z-T	T	6.7/104.4
C2262	4030017330	S.CER C1005 JF 1C 104Z-T	T	58.5/100.4
C2264	4030017330	S.CER C1005 JF 1C 104Z-T	T	61.9/88.9
C2266	4030017330	S.CER C1005 JF 1C 104Z-T	T	72.0/85.3
C2268	4030017330	S.CER C1005 JF 1C 104Z-T	T	68.6/89.5
C2269	4030017330	S.CER C1005 JF 1C 104Z-T	B	78.5/92.4
C2270	4030017780	S.CER C1005 JB 1H 472K-T	T	61.9/89.8
C2272	4030017330	S.CER C1005 JF 1C 104Z-T	T	56.3/92.3
C2274	4030017330	S.CER C1005 JF 1C 104Z-T	T	55.8/95.0
C2275	4030017330	S.CER C1005 JF 1C 104Z-T	B	68.2/99.3
C2276	4030017330	S.CER C1005 JF 1C 104Z-T	B	64.2/100.6
C2277	4030017330	S.CER C1005 JF 1C 104Z-T	T	63.6/103.5
C2278	4030017330	S.CER C1005 JF 1C 104Z-T	T	63.7/108.0
C2279	4030017330	S.CER C1005 JF 1C 104Z-T	T	62.8/108.9
C2280	4030017420	S.CER C1005 CH 1H 470J-T	T	51.8/37.9
C2281	4030017330	S.CER C1005 JF 1C 104Z-T	T	68.6/90.4
C2282	4030017330	S.CER C1005 JF 1C 104Z-T	B	80.5/93.1
C2283	4030017330	S.CER C1005 JF 1C 104Z-T	B	81.7/92.2
C2285	4030017330	S.CER C1005 JF 1C 104Z-T	T	50.8/99.1
C2286	4030017330	S.CER C1005 JF 1C 104Z-T	T	14.2/88.9
C2301	4030018910	S.CER C1608 JB 0J 475K-T	T	30.8/106.9
C2302	4030018910	S.CER C1608 JB 0J 475K-T	T	27.9/109.5
C2303	4550007310	S.TAN F930J227MNMBA	T	84.4/110.4
C2311	4030017330	S.CER C1005 JF 1C 104Z-T	B	68.1/110.3
C2312	4030018910	S.CER C1608 JB 0J 475K-T	B	67.4/105.0
C2401	4030017330	S.CER C1005 JF 1C 104Z-T	B	90.8/103.8
C2402	4030017330	S.CER C1005 JF 1C 104Z-T	B	81.2/100.7
C2403	4030017780	S.CER C1005 JB 1H 472K-T	B	77.2/28.8
C2405	4030017330	S.CER C1005 JF 1C 104Z-T	T	74.3/79.3
C2406	4030017460	S.CER C1005 JB 1H 102K-T	B	88.5/99.8
C2407	4030017330	S.CER C1005 JF 1C 104Z-T	T	74.1/78.2
C2408	4030017330	S.CER C1005 JF 1C 104Z-T	B	84.9/96.2
C2409	4030017330	S.CER C1005 JF 1C 104Z-T	T	75.6/77.6
C2410	4030017330	S.CER C1005 JF 1C 104Z-T	B	88.5/85.8
C2411	4030017330	S.CER C1005 JF 1C 104Z-T	B	81.1/96.5
C2412	4510008630	S.ELE 16 CE 47 FE	B	62.1/30.4
C2413	4030017330	S.CER C1005 JF 1C 104Z-T	B	88.5/93.7
C2414	4030017780	S.CER C1005 JB 1H 472K-T	T	84.0/95.6
C2415	4030017780	S.CER C1005 JB 1H 472K-T	B	88.4/28.1
C2417	4030017330	S.CER C1005 JF 1C 104Z-T	B	88.4/27.2
C2418	4030017330	S.CER C1005 JF 1C 104Z-T	B	82.6/94.1
C2419	4030017330	S.CER C1005 JF 1C 104Z-T	B	88.5/86.7
C2422	4030017330	S.CER C1005 JF 1C 104Z-T	T	84.8/87.3
C2423	4030017420	S.CER C1005 CH 1H 470J-T	B	62.2/141.2
C2424	4510008630	S.ELE 16 CE 47 FE	B	69.2/31.4
C2426	4030017330	S.CER C1005 JF 1C 104Z-T	B	68.8/82.2
C2427	4030012600	S.CER C2012 JB 1A 105M-T	T	85.1/91.4
C2501	4030017330	S.CER C1005 JF 1C 104Z-T	B	8.1/94.3
C2502	4030018960	S.CER C3216 JB 1C 106MT-N	B	11.5/95.2
C2503	4030016970	S.CER C1005 JB 1E 223K-T	B	14.9/89.3
C2505	4030016940	S.CER C1005 JB 1A 393K-T	B	17.4/91.4
C2506	4030017780	S.CER C1005 JB 1H 472K-T	B	18.3/93.8
C2507	4030017490	S.CER C1608 JB 1A 105K-T	B	12.8/89.3
C2551	4030017330	S.CER C1005 JF 1C 104Z-T	B	43.0/124.1
C2552	4030018960	S.CER C3216 JB 1C 106MT-N	B	47.9/118.8
C2553	4030016970	S.CER C1005 JB 1E 223K-T	B	51.4/124.7
C2554	4030018390	S.CER C1005 JB 1A 563K-T	B	53.9/122.0
C2555	4030017760	S.CER C1005 JB 1H 222K-T	B	53.9/121.1
C2556	4030017770	S.CER C1005 JB 1H 332K-T	B	52.9/123.8
C2557	4030017330	S.CER C1005 JF 1C 104Z-T	B	41.8/120.9
C2558	4030018960	S.CER C3216 JB 1C 106MT-N	B	43.0/118.5
C2561	4030018960	S.CER C3216 JB 1C 106MT-N	B	56.5/124.4
C2562	4030018960	S.CER C3216 JB 1C 106MT-N	B	53.4/126.5
C2563	4550007970	S.TAN TMCMC1A107MTRF	B	75.3/122.8
C2564	4030018080	S.CER C1005 JB 1H 182K-T	B	47.8/125.6
C2565	4030017430	S.CER C1005 CH 1H 101J-T	B	44.6/122.6
C2566	4030018090	S.CER C1005 JB 1E 822K-T	B	46.2/124.3
C2601	4030017330	S.CER C1005 JF 1C 104Z-T	B	59.8/125.2
C2603	4030010210	S.CER C3216 JB 1C 105M-T	B	87.6/126.1
C2604	4030016970	S.CER C1005 JB 1E 223K-T	B	89.2/128.6
C2605	4030017330	S.CER C1005 JF 1C 104Z-T	B	83.9/133.7
C2606	4510009250	S.ELE EEEFK1C471P	T	69.2/137.4
C2607	4510008650	S.ELE EEEFK1C221P	T	58.5/138.4
C2608	4030017330	S.CER C1005 JF 1C 104Z-T	B	87.6/128.6
C2610	4510009250	S.ELE EEEFK1C471P	T	6.2/65.3
C2612	4030017330	S.CER C1005 JF 1C 104Z-T	B	34.0/123.9
C2613	4510009250	S.ELE EEEFK1C471P	T	31.8/131.5
C2616	4030017780	S.CER C1005 JB 1H 472K-T	B	31.6/134.3
C2617	4030017780	S.CER C1005 JB 1H 472K-T	T	33.5/126.0
C2618	4030017430	S.CER C1005 CH 1H 101J-T	B	31.6/133.4
C2619	4030017780	S.CER C1005 JB 1H 472K-T	T	67.8/112.7
C2620	4510008630	S.ELE 16 CE 47 FE	B	82.9/119.2
C2621	4510008500	S.ELE EEE1CA101WP	T	49.2/138.4
C2622	4510008500	S.ELE EEE1CA101WP	T	60.2/130.4
C2624	4030017330	S.CER C1005 JF 1C 104Z-T	B	38.5/124.5
CP1601	6910009670	S.CHE HK3-S-T	T	11.8/54.7
J1	6510028210	CON SJ050010 (TMP-J01X-V6)		
J101	6510028210	CON SJ050010 (TMP-J01X-V6)		
J401	6510028210	CON SJ050010 (TMP-J01X-V6)		
J801	6510028210	CON SJ050010 (TMP-J01X-V6)		
J2002	6510019971	S.CON 52808-1071	T	39.0/12.6

Eqv.= This component is equivalent to the REF No. component listed above, and may be substituted on parts orders and repairs.

[MAIN UNIT]

REF NO.	PARTS NO.	DESCRIPTION	M.	H/V LOCATION
J2003	6510024861	S.CON 5406721-2	T	18.7/137.8
J2004	6510023512	S.CON 28FLT-SM2-TB(LF)(SN)(M)	T	82.4/4.9
J2005	6510023512	S.CON 28FLT-SM2-TB(LF)(SN)(M)	T	66.0/4.9
J2231	6510018961	S.CON B2B-PH-SM4-TB(LF)(SN)	T	51.6/129.5
J2251	6510022881	S.CON AXK5S30347YG	T	12.3/96.6
J2252	6510024821	S.CON AXK5S60347YG	T	72.4/101.1
J2401	6510025771	S.CON 03-935H1-72BKA	B	57.7/136.6
J2402	6510025771	S.CON 03-935H1-72BKA	B	47.0/136.6
J2403	6510019371	S.CON B3B-ZR-SM4-TF(LF)(SN)	T	94.8/1.9
J2405	6510024880	S.CON 52689-3087	T	90.3/93.9
J2406	6510024880	S.CON 52689-3087	T	90.3/71.0
J2407	6510025771	S.CON 03-935H1-72BKA	B	68.4/136.6
J2601	6510014961	S.CON B2B-ZR-SM4-TF(LF)(SN)	T	42.7/128.8
J2602	6510025771	S.CON 03-935H1-72BKA	B	36.3/136.6
W1	9029701008	WIR 72/98/020/X98/X98		
W601	9029701008	WIR 72/98/020/X98/X98		
EP511	6910012350	S.BEA MMZ1608Y 102BT	T	44.2/26.5
EP1951	6910014730	S.BEA MPZ2012S331A-T	B	61.4/116.7
EP1952	6910014730	S.BEA MPZ2012S331A-T	B	26.8/113.4
EP1953	6910014730	S.BEA MPZ2012S331A-T	B	10.0/104.5
EP1954	6910014730	S.BEA MPZ2012S331A-T	B	50.4/107.3
EP2001	6910012350	S.BEA MMZ1608Y 102BT	B	74.2/5.3
EP2002	6910012350	S.BEA MMZ1608Y 102BT	B	34.7/12.6
EP2003	6910012350	S.BEA MMZ1608Y 102BT	B	33.5/13.8
EP2004	6910012350	S.BEA MMZ1608Y 102BT	B	39.6/15.9
EP2006	6910014730	S.BEA MPZ2012S331A-T	B	42.2/13.4
EP2007	6910012350	S.BEA MMZ1608Y 102BT	B	45.2/11.1
EP2008	6910012350	S.BEA MMZ1608Y 102BT	B	45.2/14.8
EP2231	6910012350	S.BEA MMZ1608Y 102BT	T	59.9/125.8
EP2251	6910012350	S.BEA MMZ1608Y 102BT	T	4.6/95.5
EP2252	6910012350	S.BEA MMZ1608Y 102BT	T	7.5/98.3
EP2253	6910012350	S.BEA MMZ1608Y 102BT	T	66.1/109.3
EP2254	6910012350	S.BEA MMZ1608Y 102BT	T	65.8/108.1
EP2255	6910012350	S.BEA MMZ1608Y 102BT	T	17.9/101.5
EP2256	6910012350	S.BEA MMZ1608Y 102BT	T	65.1/106.0
EP2257	6910012350	S.BEA MMZ1608Y 102BT	T	65.1/104.8
EP2258	6910012350	S.BEA MMZ1608Y 102BT	B	78.0/93.5
EP2259	6910012350	S.BEA MMZ1608Y 102BT	B	68.1/102.6
EP2260	6910012350	S.BEA MMZ1608Y 102BT	B	68.2/101.4
EP2261	6910012350	S.BEA MMZ1608Y 102BT	B	66.1/98.3
EP2262	6910012350	S.BEA MMZ1608Y 102BT	T	69.9/85.6
EP2263	6910014730	S.BEA MPZ2012S331A-T	T	6.5/93.9
EP2264	6910012350	S.BEA MMZ1608Y 102BT	B	69.4/111.3
EP2265	6910012350	S.BEA MMZ1608Y 102BT	B	68.7/98.3
EP2266	6910012350	S.BEA MMZ1608Y 102BT	T	56.3/93.1
EP2271	6910012350	S.BEA MMZ1608Y 102BT	T	74.6/91.1
EP2402	6910012350	S.BEA MMZ1608Y 102BT	B	51.2/129.6
EP2403	6910012350	S.BEA MMZ1608Y 102BT	B	48.5/129.6
EP2404	6910012350	S.BEA MMZ1608Y 102BT	B	68.6/129.4
EP2405	6910012350	S.BEA MMZ1608Y 102BT	B	62.2/134.9
EP2408	6910012350	S.BEA MMZ1608Y 102BT	B	91.3/102.8
EP2409	6910012350	S.BEA MMZ1608Y 102BT	T	85.3/101.2
EP2410	6910012350	S.BEA MMZ1608Y 102BT	T	84.7/98.4
EP2411	6910012350	S.BEA MMZ1608Y 102BT	T	85.2/79.2
EP2412	6910012350	S.BEA MMZ1608Y 102BT	T	82.6/78.5
EP2413	6910012350	S.BEA MMZ1608Y 102BT	B	72.5/129.3
EP2414	6910012350	S.BEA MMZ1608Y 102BT	B	89.4/91.1
EP2415	6910012350	S.BEA MMZ1608Y 102BT	T	85.0/100.0
EP2416	6910012350	S.BEA MMZ1608Y 102BT	T	80.0/77.6
EP2417	6910012350	S.BEA MMZ1608Y 102BT	B	87.2/78.8
EP2602	6910014730	S.BEA MPZ2012S331A-T	T	36.0/125.7
EP2604	6910014730	S.BEA MPZ2012S331A-T	T	31.6/135.7
EP2605	6910014730	S.BEA MPZ2012S331A-T	B	43.0/135.5
EP2606	6910014730	S.BEA MPZ2012S331A-T	T	41.4/133.7

M.=Mounted side (T: Mounted on the Top side, B: Mounted on the Bottom side) S.=Surface mount

[PA UNIT]

REF NO.	PARTS NO.	DESCRIPTION	M.	H/V LOCATION
IC471	1110005630	S.IC UPC3215TB-E3-A	B	67.6/96.4
IC701	1180002010	S.REG BA08FF-E2	B	126.3/41.9
IC960	1110002700	S.IC NJM2904M-TE1-#FMZB	B	41.0/132.1
IC981	1130012720	S.IC CD74HC4094PWR	T	26.2/5.9
Q101	1560001091	S.FET 2SK2854(T2LICOMF)	T	149.2/28.5
Q102	1560001241	S.FET RD01MUS1-T113	T	146.0/40.1
Q301	1560001601	FET RD70HHF1C-102		
Q302	1560001601	FET RD70HHF1C-102		
Q401	1560001611	FET RD60HUF1C-101		
Q402	1590000680	S.TRA DTC114EUA T106	B	87.7/132.8
Q403	1590000680	S.TRA DTC114EUA T106	B	90.1/130.4
Q451	1580000691	S.FET 3SK291(TE85RF)	B	76.8/108.4
Q452	1590003940	S.TRA RN1105(TE85LF)	B	67.5/115.8
Q453	1590003940	S.TRA RN1105(TE85LF)	B	75.1/119.9
Q501	1560001591	FET RD70HVF1C-121		
Q502	1590000680	S.TRA DTC114EUA T106	T	87.7/107.5
Q503	1590000680	S.TRA DTC114EUA T106	T	87.7/110.0
Q551	1580000691	S.FET 3SK291(TE85RF)	T	68.4/108.9
Q552	1590003940	S.TRA RN1105(TE85LF)	T	63.0/110.1
Q700	1590003940	S.TRA RN1105(TE85LF)	B	126.5/25.0
Q741	1590003940	S.TRA RN1105(TE85LF)	B	79.4/9.0
Q742	1520000460	S.TRA 2SB1132 T100 R	B	83.7/8.3
Q980	1590003940	S.TRA RN1105(TE85LF)	T	51.3/84.6
Q981	1590003940	S.TRA RN1105(TE85LF)	T	51.5/13.8
Q982	1590003940	S.TRA RN1105(TE85LF)	T	53.8/97.3
Q983	1590003940	S.TRA RN1105(TE85LF)	T	51.3/57.0
Q984	1590003940	S.TRA RN1105(TE85LF)	T	51.6/97.2
Q985	1590003940	S.TRA RN1105(TE85LF)	T	51.3/27.9
Q986	1590003940	S.TRA RN1105(TE85LF)	T	51.3/71.5
Q987	1590003940	S.TRA RN1105(TE85LF)	T	52.5/41.6
Q988	1590004030	S.TRA KRX204U-RTK/P	T	58.3/90.3
D102	1750000301	S.DIO 1SS302(TE85RF)	T	152.5/19.9
D151	1750000581	S.DIO 1SV307(TPH3F)	T	59.6/56.4
D152	1790001251	S.DIO MA251110GL	T	56.4/58.5
D301	1160000060	S.DIO DAN202U T106	T	105.1/80.8
D302	1160000060	S.DIO DAN202U T106	T	74.9/87.3
D401	1790001241	S.DIO MA257280GL	B	128.0/133.6
D402	1790001241	S.DIO MA257280GL	B	127.5/139.6
D403	1790001241	S.DIO MA257280GL	B	123.5/140.6
D404	1790001241	S.DIO MA257280GL	B	125.6/132.8
D406	1710001061	DIO L407CDB		
D407	1710001061	DIO L407CDB		
D408	1750000511	S.DIO UX9401F-STD/TR <INT>	B	97.7/136.4
D409	1750000511	S.DIO UX9401F-STD/TR <INT>	B	103.6/133.1
D410	1750000511	S.DIO UX9401F-STD/TR <INT>	B	104.8/130.1
D411	1790001251	S.DIO MA251110GL	B	94.2/129.2
D412	1160000070	S.DIO DAN202K T146	B	91.7/127.1
D451	1750000581	S.DIO 1SV307(TPH3F)	B	85.5/116.4
D452	1750000581	S.DIO 1SV307(TPH3F)	B	82.4/116.0
D453	1720000701	S.VAR 1SV305(TPL3F)	T	75.6/117.3
D454	1720000701	S.VAR 1SV305(TPL3F)	T	77.8/116.6
D455	1720000701	S.VAR 1SV305(TPL3F)	B	75.7/99.2
D456	1720000701	S.VAR 1SV305(TPL3F)	B	67.4/104.2
D461	1750000581	S.DIO 1SV307(TPH3F)	B	65.1/93.6
D462	1750000581	S.DIO 1SV307(TPH3F)	T	65.6/94.7
D501	1790000971	S.DIO MA2J7290GL	B	113.7/123.5
D502	1790000971	S.DIO MA2J7290GL	B	116.4/122.8
D503	1790000971	S.DIO MA2J7290GL	B	114.5/129.5
D504	1790000971	S.DIO MA2J7290GL	B	111.0/129.5
D506	1710001061	DIO L407CDB		
D507	1750000511	S.DIO UX9401F-STD/TR <INT>	B	92.7/117.4
D508	1750000511	S.DIO UX9401F-STD/TR <INT>	T	87.0/114.4
D509	1750000511	S.DIO UX9401F-STD/TR <INT>	T	81.9/120.3
D510	1710001061	DIO L407CDB		
D511	1750000581	S.DIO 1SV307(TPH3F)	B	95.4/112.2
D551	1750000581	S.DIO 1SV307(TPH3F)	T	74.0/116.8
D552	1750000581	S.DIO 1SV307(TPH3F)	T	72.3/116.8
D553	1750000610	S.VAR MA2SV0500L	T	67.2/118.6
D554	1750000610	S.VAR MA2SV0500L	T	69.6/117.9
D555	1750000581	S.DIO 1SV307(TPH3F)	T	66.9/116.7
D556	1720000590	S.VAR MA357(TX)	T	71.6/113.3
D557	1750000581	S.DIO 1SV307(TPH3F)	T	68.1/105.0
D558	1720000590	S.VAR MA357(TX)	T	72.2/104.3
D559	1750000610	S.VAR MA2SV0500L	T	69.0/102.7
D560	1750000610	S.VAR MA2SV0500L	T	71.8/101.3
D701	1790000700	DIO DSA3A1		
D702	1790000700	DIO DSA3A1		
D703	1160000070	S.DIO DAN202K T146	B	126.5/21.5
D704	1790001241	S.DIO MA257280GL	B	87.9/114.0
D705	1160000070	S.DIO DAN202K T146	B	137.5/14.3
D706	1790001241	S.DIO MA257280GL	B	86.0/113.1
D801	1750000301	S.DIO 1SS302(TE85RF)	B	42.7/41.8
D820	1750000301	S.DIO 1SS302(TE85RF)	B	54.4/94.6
D840	1750000301	S.DIO 1SS302(TE85RF)	B	43.4/99.8
D860	1750000301	S.DIO 1SS302(TE85RF)	B	43.0/86.0
D880	1750000301	S.DIO 1SS302(TE85RF)	B	43.3/71.7
D900	1750000301	S.DIO 1SS302(TE85RF)	B	43.7/56.9
D920	1750000301	S.DIO 1SS302(TE85RF)	B	43.0/28.1
D940	1750000301	S.DIO 1SS302(TE85RF)	B	41.1/14.3
D961	1790000491	S.DIO HSM88ASTR-E	B	28.2/130.2
D962	1790000491	S.DIO HSM88ASTR-E	B	28.2/133.8
D964	1750000511	S.DIO UX9401F-STD/TR <INT>	B	40.1/43.9
D965	1750000511	S.DIO UX9401F-STD/TR <INT>	B	42.8/48.0
L101	6200005051	S.COI NLV25T-330J	T	151.3/33.6
L102	6200008570	S.COI LQW2BHN6N8D03L	T	152.3/37.3
L103	6180003960	COI AL04 TB 101K <TRIA>		
L104	6180003960	COI AL04 TB 101K <TRIA>		
L105	6200003950	S.COI HF50ACC 322513-T	B	135.7/34.1
L107	6200002631	S.COI NLV25T-R10J	T	141.0/47.9

Eqv.= This component is equivalent to the REF No. component listed above, and may be substituted on parts orders and repairs.

[PA UNIT]

REF NO.	PARTS NO.	DESCRIPTION	M.	H/V LOCATION
L108	6200003031	S.COI NLV32T-R47J	B	138.1/41.8
L151	6200003941	S.COI NLV25T-5R6J	B	64.2/41.0
L152	6200005521	S.COI NLV25T-470J	B	64.8/38.1
L201	6140004580	S.COI LR-515	T	150.4/52.5
L203	6200010040	S.COI AS100340-10N	T	113.8/79.5
L204	6200010040	S.COI AS100340-10N	T	123.5/69.7
L301	6140003410	COI LR-383		
L302	2040000490	COI EXC-ELDR25C		
L303	6140003590	COI LR-400 (TR10X5X5 6H3)		
L304	6140004570	COI LR-507		
L305	6140004560	COI LR-506		
L306	6110001730	COI LA-262		
L404	6200010060	S.COI AS080647-56N	T	141.1/109.0
L407	6200010170	S.COI AS080447-33N	T	146.6/110.8
L408	2040000490	COI EXC-ELDR25C		
L409	2040000490	COI EXC-ELDR25C		
L410	6200010040	S.COI AS100340-10N	T	126.6/137.8
L411	6200010420	S.COI FHW1210HC 1R0JGT <JJE>	T	118.3/136.7
L412	6200010160	S.COI AS080440-22N	T	104.5/134.4
L413	6200010150	S.COI AS080340-15N	T	88.3/139.6
L414	6200010150	S.COI AS080340-15N	T	81.0/133.6
L415	6200012960	S.COI 0.45-1.4-4-TL 12.1N <COMO>	T	99.2/134.0
L416	6200013000	S.COI 0.25-1.9-13TL 135N <COMO>	T	93.8/132.1
L417	6200007790	S.COI LQW2BHN15N03L	B	98.3/131.1
L441	6200010040	S.COI AS100340-10N	T	133.4/137.8
L451	6200005621	S.COI ELJRE 4N7ZFA	B	81.5/120.1
L452	6200012660	S.COI 0.30-1.0-4TR 9.1N <COMO>	T	76.7/114.9
L453	6200007230	S.COI LQW2BHN15N03L	B	74.1/104.1
L454	6200007230	S.COI LQW2BHN15N03L	B	70.0/102.4
L501	6200010780	S.COI C2520C-1R0G-A	T	117.1/86.6
L502	6200010600	S.COI AS080647-56N	T	118.1/125.0
L504	6200010780	S.COI C2520C-1R0G-A	T	105.8/123.5
L505	6200010070	S.COI AS080747-68N	T	90.2/118.6
L506	6200010170	S.COI AS080447-33N	T	92.0/124.3
L507	6200012910	S.COI 0.35-1.6-8TL 45.5N <COMO>	T	84.7/118.0
L508	6200010050	S.COI AS080547-47N	T	81.9/127.7
L509	6200010780	S.COI C2520C-1R0G-A	T	93.2/113.2
L510	6200010050	S.COI AS080547-47N	T	75.5/127.5
L531	6110003980	COI LA-604		
L541	6200010070	S.COI AS080747-68N	T	128.6/129.9
L551	6200007700	S.COI LQW2BHN22N03L	T	76.1/120.8
L552	6200007720	S.COI LQW2BHN33N03L	T	70.9/121.3
L553	6200008090	S.COI LQW2BHN68N03L	T	65.2/121.7
L554	6200003640	S.COI MLF1608E 100K-T	T	64.9/114.8
L555	6200003711	S.COI NLV25T-2R7J	T	65.2/105.4
L556	6200003640	S.COI MLF1608E 100K-T	B	65.0/109.6
L557	6200007760	S.COI LQW2BHN82N03L	T	66.8/100.5
L558	6200007710	S.COI LQW2BHN27N03L	T	69.9/98.4
L560	6200002611	S.COI NLV25T-R47J	T	62.9/97.3
L601	6200010040	S.COI AS100340-10N	T	69.3/127.6
L602	6200010160	S.COI AS080440-22N	T	65.7/132.8
L603	6200010150	S.COI AS080340-15N	T	60.9/133.6
L705	6200003550	S.COI MLF1608A 4R7K-T	B	68.2/10.3
L706	6200011300	S.COI EXCML16A270U	T	91.0/6.9
L707	6200011300	S.COI EXCML16A270U	T	91.0/5.6
L801	6200011410	S.COI C2520C-82NG-A	T	55.8/55.5
L802	6200010650	S.COI C2520C-R12G-A (0.12U)	T	58.5/52.1
L803	6200007420	S.COI ELJFC 101K-F	B	50.5/39.8
L820	6200006430	S.COI ELJFC 180K-F	B	52.9/97.4
L821	6140002020	COI LR-229 (T50-10)		
L822	6140003540	COI LR-396		
L823	6200006430	S.COI ELJFC 180K-F	B	2.8/106.8
L840	6200007420	S.COI ELJFC 101K-F	B	49.3/98.5
L841	6140001820	COI LR-218 (T50-10)		
L842	6140001800	COI LR-216 (T50-2)		
L843	6140001800	COI LR-216 (T50-2)		
L844	6200007420	S.COI ELJFC 101K-F	B	2.6/90.7
L860	6200004440	S.COI ELJFC 4R7M-F	B	50.3/83.8
L861	6110003550	COI LA-547 (LA-214A)		
L862	6110003570	COI LA-550		
L863	6110003540	COI LA-548 (LA-215A)		
L864	6200004440	S.COI ELJFC 4R7M-F	B	2.8/74.5
L880	6200007420	S.COI ELJFC 101K-F	B	50.4/69.1
L881	6140002570	COI LR-294 (T50-2)		
L882	6140002580	COI LR-295 (T50-2)		
L883	6200007420	S.COI ELJFC 101K-F	B	2.6/58.4
L900	6200008600	S.COI ELJFC 560K-F	B	50.0/54.6
L901	6140002560	COI LR-293 (T50-10)		
L902	6140002560	COI LR-293 (T50-10)		
L903	6140002560	COI LR-293 (T50-10)		
L904	6200008600	S.COI ELJFC 560K-F	B	2.6/42.3
L920	6200007420	S.COI ELJFC 101K-F	B	50.4/25.4
L921	6140001780	COI LR-214 (T50-2)		
L922	6140001780	COI LR-214 (T50-2)		
L923	6200007420	S.COI ELJFC 101K-F	B	2.6/26.1
L940	6200007390	S.COI ELJFC 120K-F	B	47.3/9.9
L941	6140003450	COI LR-387 (T50-10)		
L942	6140003460	COI LR-388 (T50-10)		
L943	6200007420	S.COI ELJFC 101K-F	B	41.1/11.1
L944	6200007390	S.COI ELJFC 120K-F	B	9.0/10.5
L960	6200007420	S.COI ELJFC 101K-F	B	45.3/130.6
L961	6140003490	COI LR-391 (TR10X5X5 3A6)		

[PA UNIT]

REF NO.	PARTS NO.	DESCRIPTION	M.	H/V LOCATION
R109	7030008190	S.RES ERJ12YJ330U (33)	B	145.5/32.7
R110	7030002030	S.RES MCR10EZJH 56 (560)	T	149.4/39.8
R111	7030003410	S.RES ERJ3GEYJ 561 V (560)	B	143.8/42.1
R112	7030003510	S.RES ERJ3GEYJ 392 V (3.9K)	B	146.1/37.5
R113	7030003540	S.RES ERJ3GEYJ 682 V (6.8K)	B	146.1/37.5
R116	7030000340	S.RES MCR10EZJH 470 (471)	B	141.4/40.9
R117	7030003860	S.RES ERJ3GE JPW V	T	146.7/47.7
R151	7030003380	S.RES ERJ3GEYJ 331 V (330)	B	61.6/37.8
R152	7030003440	S.RES ERJ3GEYJ 102 V (1K)	B	61.8/60.1
R153	7030003520	S.RES ERJ3GEYJ 472 V (4.7K)	T	59.2/58.0
R201	7030003320	S.RES ERJ3GEYJ 101 V (100)	B	123.0/50.1
R202	7030003520	S.RES ERJ3GEYJ 472 V (4.7K)	B	136.0/49.9
R204	7030003440	S.RES ERJ3GEYJ 102 V (1K)	B	138.0/52.8
R205	7030010420	S.RES ERJ1TYJ 560U (56)	B	145.0/51.5
R301	7030009300	S.RES ERJ1WYOR00U	B	92.2/84.4
R302	7030010520	S.RES ERJ1TYJ 101U (100)	T	89.4/86.1
R303	7030009300	S.RES ERJ1WYOR00U	B	85.4/84.4
R304	7030003320	S.RES ERJ3GEYJ 101 V (100)	T	107.1/79.8
R305	7030010410	S.RES ERJ1TYJ 220U (22)	T	100.2/84.1
R306	7030003320	S.RES ERJ3GEYJ 101 V (100)	B	71.3/83.3
R307	7030010410	S.RES ERJ1TYJ 220U (22)	T	77.5/84.1
R308	7030003480	S.RES ERJ3GEYJ 222 V (2.2K)	B	99.1/85.0
R309	7030003480	S.RES ERJ3GEYJ 222 V (2.2K)	B	78.8/85.0
R310	7030007630	S.RES MCR100JZHJ 0.68 (R68)	B	100.1/82.2
R311	7030007630	S.RES MCR100JZHJ 0.68 (R68)	B	78.3/82.1
R312	7030011250	S.RES ERJ1TYJ 390U (39)	T	100.9/77.7
R313	7030010540	S.RES ERJ1TYJ 330U (33)	T	97.2/77.7
R314	7030010540	S.RES ERJ1TYJ 330U (33)	T	81.6/77.7
R315	7030011250	S.RES ERJ1TYJ 390U (39)	T	77.9/77.7
R317	7030010950	S.RES ERJ1TYJ 100U (10)	B	104.0/20.6
R318	7030010950	S.RES ERJ1TYJ 100U (10)	B	99.6/20.6
R319	7030010660	S.RES ERJ1TYJ 6R8U (6.8)	B	89.4/54.6
R402	7030003320	S.RES ERJ3GEYJ 101 V (100)	B	151.7/73.2
R403	7030003520	S.RES ERJ3GEYJ 472 V (4.7K)	T	151.8/71.3
R404	7030000260	S.RES MCR10EZJH 100 (101)	T	149.5/76.0
R405	7030003540	S.RES ERJ3GEYJ 682 V (6.8K)	B	126.8/137.6
R406	7030003860	S.RES ERJ3GE JPW V	B	128.4/136.1
R407	7030003440	S.RES ERJ3GEYJ 102 V (1K)	B	129.7/133.6
R408	7030003860	S.RES ERJ3GE JPW V	B	124.1/137.6
R409	7030003440	S.RES ERJ3GEYJ 102 V (1K)	B	127.1/130.4
R410	7030003440	S.RES ERJ3GEYJ 102 V (1K)	B	131.6/133.0
R411	7030003540	S.RES ERJ3GEYJ 682 V (6.8K)	B	125.2/135.5
R412	7030003500	S.RES ERJ3GEYJ 332 V (3.3K)	B	131.1/129.7
R413	7030007160	S.RES ERJ12YJ3R3U (3.3)	B	123.6/125.2
R415	7030008350	S.RES ERJ12YJ390U	B	86.8/136.5
R416	7030000140	S.RES MCR10EZJH 10 (100)	B	93.8/130.8
R417	7030000140	S.RES MCR10EZJH 10 (100)	B	95.6/132.5
R418	7030000010	S.RES MCR10EZJH JPW (000)	B	99.4/133.9
R451	7030003470	S.RES ERJ3GEYJ 182 V (1.8K)	B	81.5/121.7
R452	7030004040	S.RES ERJ3GEYJ 4R7 V (4.7)	B	85.5/119.3
R453	7030003260	S.RES ERJ3GEYJ 330 V (33)	B	81.6/118.4
R454	7030003860	S.RES ERJ3GE JPW V	B	77.3/116.0
R455	7030003640	S.RES ERJ3GEYJ 473 V (47K)	B	73.2/117.5
R456	7030003700	S.RES ERJ3GEYJ 154 V (150K)	B	72.0/114.5
R457	7030003750	S.RES ERJ3GEYJ 394 V (390K)	B	71.2/111.9
R458	7030003710	S.RES ERJ3GEYJ 184 V (180K)	B	73.9/112.5
R459	7030003740	S.RES ERJ3GEYJ 334 V (330K)	B	69.6/111.3
R460	7030003740	S.RES ERJ3GEYJ 334 V (330K)	B	76.7/112.1
R461	7030003270	S.RES ERJ3GEYJ 390 V (39)	B	77.7/103.4
R462	7030003680	S.RES ERJ3GEYJ 104 V (100K)	B	72.9/99.6
R463	7030003520	S.RES ERJ3GEYJ 472 V (4.7K)	B	74.4/102.4
R464	7030003210	S.RES ERJ3GEYJ 120 V (12)	B	74.1/105.7
R465	7030003680	S.RES ERJ3GEYJ 104 V (100K)	B	66.6/101.8
R466	7030003860	S.RES ERJ3GE JPW V	B	62.2/100.2
R467	7030003640	S.RES ERJ3GEYJ 473 V (47K)	B	75.1/117.2
R468	7030008240	S.RES ERJ12YR00U	B	89.2/122.0
R470	7030003320	S.RES ERJ3GEYJ 101 V (100)	B	67.8/98.9
R471	7030003270	S.RES ERJ3GEYJ 390 V (39)	B	69.7/98.3
R472	7030003340	S.RES ERJ3GEYJ 151 V (150)	B	69.7/99.5
R473	7030003340	S.RES ERJ3GEYJ 151 V (150)	B	69.7/100.7
R474	7030003340	S.RES ERJ3GEYJ 151 V (150)	B	63.5/97.0
R475	7030003340	S.RES ERJ3GEYJ 151 V (150)	B	60.9/97.0
R476	7030003270	S.RES ERJ3GEYJ 390 V (39)	B	64.9/95.1
R477	7030003360	S.RES ERJ3GEYJ 221 V (220)	B	61.8/97.6
R502	7030003320	S.RES ERJ3GEYJ 101 V (100)	T	112.1/87.9
R503	7030003520	S.RES ERJ3GEYJ 472 V (4.7K)	T	112.6/86.0
R504	7030000260	S.RES MCR10EZJH 100 (101)	T	114.2/86.2
R505	7030003540	S.RES ERJ3GEYJ 682 V (6.8K)	B	120.0/124.8
R507	7030003440	S.RES ERJ3GEYJ 102 V (1K)	B	110.2/123.1
R508	7030003520	S.RES ERJ3GEYJ 472 V (4.7K)	B	107.1/121.5
R510	7030003440	S.RES ERJ3GEYJ 102 V (1K)	B	110.4/125.8
R511	7030003540	S.RES ERJ3GEYJ 682 V (6.8K)	B	112.1/134.0
R512	7030003560	S.RES ERJ3GEYJ 103 V (10K)	B	107.1/123.1
R513	7030010520	S.RES ERJ1TYJ 101U (100)	B	103.7/114.2
R515	7030006060	S.RES ERJ12YJ100U (10)	T	92.1/109.0
R516	7030003860	S.RES ERJ3GE JPW V	T	90.6/114.3
R517	7030010520	S.RES ERJ1TYJ 101U (100)	B	103.7/118.4
R518	7030003440	S.RES ERJ3GEYJ 102 V (1K)	B	97.5/112.7
R519	7030000010	S.RES MCR10EZJH JPW (000)	B	111.2/119.1
R551	7030003470	S.RES ERJ3GEYJ 182 V (1.8K)	T	78.2/117.8
R552	7030004040	S.RES ERJ3GEYJ 4R7 V (4.7)	T	76.7/119.1
R553	7030003260	S.RES ERJ3GEYJ 330 V (33)	T	73.1/119.0
R554	7030003680	S.RES ERJ3GEYJ 104 V (100K)	T	66.8/120.5
R555	7030003440	S.RES ERJ3GEYJ 102 V (1K)	T	68.1/114.7
R556	7030003680	S.RES ERJ3GEYJ 104 V (100K)	T	70.0/116.7
R557	7030003740	S.RES ERJ3GEYJ 334 V (330K)	T	65.7/112.9
R558	7030003710	S.RES ERJ3GEYJ 184 V (180K)	T	70.5/111.2
R559	7030003720	S.RES ERJ3GEYJ 224 V (220K)	T	65.7/111.7
R560	7030003720	S.RES ERJ3GEYJ 224 V (220K)	T	65.6/110.5
R561	7030003740	S.RES ERJ3GEYJ 334 V (330K)	T	68.3/112.4
R562	7030003270	S.RES ERJ3GEYJ 390 V (39)	T	70.1/106.6
R563	7030003420	S.RES ERJ3GEYJ 681 V (680)	T	65.4/107.3
R564	7030003210	S.RES ERJ3GEYJ 120 V (12)	T	63.5/103.0
R565	7030003440	S.RES ERJ3GEYJ 102 V (1K)	B	65.7/106.4
R567	7030003680	S.RES ERJ3GEYJ 104 V (100K)	T	70.1/104.0

Eqv.= This component is equivalent to the REF No. component listed above, and may be substituted on parts orders and repairs.

[PA UNIT]

REF NO.	PARTS NO.	DESCRIPTION	M.	H/V LOCATION
R568	7030003680	S.RES ERJ3GEYJ 104 V (100K)	T	69.8/100.8
R570	7030003380	S.RES ERJ3GEYJ 331 V (330)	T	62.8/100.3
R575	7030003520	S.RES ERJ3GEYJ 472 V (4.7K)	T	68.5/100.8
R576	7030003540	S.RES ERJ3GEYJ 682 V (6.8K)	T	71.8/100.0
R577	7030003520	S.RES ERJ3GEYJ 472 V (4.7K)	T	68.0/120.5
R578	7030003540	S.RES ERJ3GEYJ 682 V (6.8K)	T	70.0/119.1
R701	7030003500	S.RES ERJ3GEYJ 332 V (3.3K)	B	82.2/16.9
R702	7030003500	S.RES ERJ3GEYJ 332 V (3.3K)	B	83.1/14.6
R703	7030003500	S.RES ERJ3GEYJ 332 V (3.3K)	B	80.6/16.9
R704	7030003500	S.RES ERJ3GEYJ 332 V (3.3K)	B	79.8/14.6
R705	7030009300	S.RES ERJ1WYOR00U	B	134.7/23.9
R721	7030011240	S.RES LRF3W-LF-01-R020F	B	83.0/22.3
R722	7030011240	S.RES LRF3W-LF-01-R020F	B	83.0/29.6
R723	7030004040	S.RES ERJ3GEYJ 4R7 V (4.7)	B	140.6/14.7
R733	7030009591	S.RES ERA3YED 472V (4.7K)	B	138.6/10.4
R734	7510001470	S.THE NTCG20 4AG 473JT	T	111.9/58.2
R735	7030009591	S.RES ERA3YED 472V (4.7K)	B	140.2/12.5
R736	7510001470	S.THE NTCG20 4AG 473JT	T	153.4/77.2
R742	7030003640	S.RES ERJ3GEYJ 473 V (47K)	B	83.4/11.5
R743	7030003440	S.RES ERJ3GEYJ 102 V (1K)	B	80.2/11.0
R744	7030003860	S.RES ERJ3GE JPW V	T	67.8/9.6
R749	7030003860	S.RES ERJ3GE JPW V	B	65.0/5.3
R750	7030003860	S.RES ERJ3GE JPW V	B	66.7/5.3
R773	7030003860	S.RES ERJ3GE JPW V	T	103.4/9.6
R960	7030003860	S.RES ERJ3GE JPW V	B	43.2/125.7
R961	7030003380	S.RES ERJ3GEYJ 331 V (330)	B	42.0/138.3
R962	7030003440	S.RES ERJ3GEYJ 102 V (1K)	B	37.4/137.9
R963	7030003440	S.RES ERJ3GEYJ 102 V (1K)	B	40.3/126.3
R964	7030003860	S.RES ERJ3GE JPW V	B	24.8/131.2
R965	7030003640	S.RES ERJ3GEYJ 473 V (47K)	B	32.6/130.6
R966	7030008190	S.RES ERJ12YJ330U (33)	B	11.1/129.6
R967	7030003640	S.RES ERJ3GEYJ 473 V (47K)	B	34.2/130.6
R968	7030003860	S.RES ERJ3GE JPW V	B	24.8/132.8
R969	7030003860	S.RES ERJ3GEYJ 223 V (22K)	B	32.6/133.7
R970	7030003680	S.RES ERJ3GEYJ 104 V (100K)	B	34.2/133.7
R971	7540000130	ABS 2P-50A-301		
R972	7030003620	S.RES ERJ3GEYJ 333 V (33K)	B	17.4/140.1
R973	7030003620	S.RES ERJ3GEYJ 333 V (33K)	B	18.9/138.5
R974	7030003620	S.RES ERJ3GEYJ 333 V (33K)	B	19.4/136.6
R994	7030003560	S.RES ERJ3GEYJ 103 V (10K)	B	22.4/2.6
R995	7030003650	S.RES ERJ3GEYJ 103 V (10K)	B	22.4/6.8
R996	7030003560	S.RES ERJ3GEYJ 103 V (10K)	B	21.6/5.4
R997	7030003560	S.RES ERJ3GEYJ 103 V (10K)	B	21.6/8.2
R998	7030003320	S.RES ERJ3GEYJ 101 V (100)	T	54.1/4.4
R999	7030003320	S.RES ERJ3GEYJ 101 V (100)	T	54.5/3.1
R1000	7030003320	S.RES ERJ3GEYJ 101 V (100)	T	51.2/3.5
R1001	7030003320	S.RES ERJ3GEYJ 101 V (100)	T	49.4/4.9
R1002	7030000280	S.RES MCR10EZJH 150 (151)	T	48.0/9.7
R1003	7030000290	S.RES MCR10EZJH 180 (181)	T	47.5/7.9
C101	4030011600	S.CER C1608 JB 1E 104K-T	T	152.0/25.2
C102	4030011600	S.CER C1608 JB 1E 104K-T	B	150.8/29.3
C103	4030011340	S.CER C1608 CH 1H 471J-T	T	152.7/27.2
C104	4030011600	S.CER C1608 JB 1E 104K-T	T	147.8/32.2
C105	4510004591	ELE 16 ME 470 HC		
C106	4030011600	S.CER C1608 JB 1E 104K-T	B	142.7/29.2
C107	4030011600	S.CER C1608 JB 1E 104K-T	T	151.6/39.7
C108	4030011600	S.CER C1608 JB 1E 104K-T	T	149.2/36.5
C109	4030007130	S.CER C1608 CH 1H 101J-T	B	146.6/42.1
C112	4030011600	S.CER C1608 JB 1E 104K-T	B	139.2/35.1
C113	4030011600	S.CER C1608 JB 1E 104K-T	T	144.6/44.4
C114	4030011600	S.CER C1608 JB 1E 104K-T	B	134.1/37.0
C116	4030007090	S.CER C1608 CH 1H 470J-T	T	144.6/45.8
C118	4030007130	S.CER C1608 CH 1H 101J-T	T	143.5/48.5
C119	4030007130	S.CER C1608 CH 1H 101J-T	T	144.0/50.4
C120	4030007120	S.CER C1608 CH 1H 120J-T	T	143.5/47.2
C122	4510008500	S.ELE EEE1CA101WP	T	121.5/11.2
C151	4030011600	S.CER C1608 JB 1E 104K-T	T	59.2/54.9
C152	4030006880	S.CER C1608 JB 1H 472K-T	B	61.6/36.2
C153	4030011600	S.CER C1608 JB 1E 104K-T	B	63.1/56.0
C154	4030006860	S.CER C1608 JB 1H 102K-T	B	63.1/54.0
C201	4030006860	S.CER C1608 JB 1H 102K-T	T	145.6/53.1
C202	4030006860	S.CER C1608 JB 1H 102K		

[PA UNIT]

REF NO.	PARTS NO.	DESCRIPTION	M.	H/V LOCATION
C303	4030011600	S.CER C1608 JB 1E 104K-T	B	110.8/85.5
C304	4030017320	S.CER GRM21BB11H104KA01L (GRM40-034)	B	94.8/97.6
C305	4510004591	ELE 16 ME 470 HC	B	83.6/39.9
C306	4030004720	S.CER C2012 JB 1H 102K-T [EUR]	B	
	4030004720	S.CER C2012 JB 1H 102K-T [FRA]		
	4030004720	S.CER C2012 JB 1H 102K-T [ESP]		
	4030004720	S.CER C2012 JB 1H 102K-T [USA]		
	4030004720	S.CER C2012 JB 1H 102K-T [ITR]		
	4030004720	S.CER C2012 JB 1H 102K-T [UK]		
	4030004720	S.CER C2012 JB 1H 102K-T [KOR]		
	4030006860	S.CER C1608 JB 1H 102K-T [AUS]		
	4030004720	S.CER C2012 JB 1H 102K-T [CHN]		
C307	4030004720	S.CER C2012 JB 1H 102K-T [EUR]	B	100.7/39.9
	4030004720	S.CER C2012 JB 1H 102K-T [FRA]		
	4030004720	S.CER C2012 JB 1H 102K-T [ESP]		
	4030004720	S.CER C2012 JB 1H 102K-T [USA]		
	4030004720	S.CER C2012 JB 1H 102K-T [ITR]		
	4030004720	S.CER C2012 JB 1H 102K-T [UK]		
	4030006860	S.CER C1608 JB 1H 102K-T [AUS]		
	4030004720	S.CER C2012 JB 1H 102K-T [CHN]		
C308	4030004720	S.CER C2012 JB 1H 102K-T [EUR]	B	92.0/11.0
	4030004720	S.CER C2012 JB 1H 102K-T [FRA]		
	4030004720	S.CER C2012 JB 1H 102K-T [ESP]		
	4030004720	S.CER C2012 JB 1H 102K-T [USA]		
	4030004720	S.CER C2012 JB 1H 102K-T [ITR]		
	4030004720	S.CER C2012 JB 1H 102K-T [UK]		
	4030004720	S.CER C2012 JB 1H 102K-T [KOR]		
	4030006860	S.CER C1608 JB 1H 102K-T [AUS]		
	4030004720	S.CER C2012 JB 1H 102K-T [CHN]		
C309	4030011600	S.CER C1608 JB 1E 104K-T	T	105.8/78.3
C311	4030018750	S.CER C3225 CH 2J 682K-T	B	92.7/78.5
C312	4030018750	S.CER C3225 CH 2J 682K-T	B	86.1/78.5
C313	4030011600	S.CER C1608 JB 1E 104K-T	T	76.8/87.8
C314	4030018750	S.CER C3225 CH 2J 682K-T	B	96.9/77.6
C315	4030018750	S.CER C3225 CH 2J 682K-T	B	81.9/77.6
C319	4030011730	S.CER GRM31M2C2H101JV01L (GRM42-6 CH)	B	110.0/48.8
C320	4030011730	S.CER GRM31M2C2H101JV01L (GRM42-6 CH)	B	71.1/48.9
C323	4030003810	S.MIC UC342H 1200J-T	B	91.5/46.4
C324	4320001050	S.MIC UC342H 3900J-T	T	94.4/40.2
C325	4320001070	S.MIC UC342H 3300J-T	B	94.4/40.7
C327	4030011790	S.CER GRM55RF52A684ZD01L (GRM44-1)	T	65.9/46.3
C331	4030011600	S.CER C1608 JB 1E 104K-T	T	108.3/78.3
C332	4030011600	S.CER C1608 JB 1E 104K-T	B	69.5/81.4
C333	4030018940	S.CER GRM31A7U2J331JW31D	B	88.4/101.8
C340	4030006860	S.CER C1608 JB 1H 102K-T	B	82.3/107.4
C341	4030006860	S.CER C1608 JB 1H 102K-T	B	92.5/107.4
C342	4030006860	S.CER C1608 JB 1H 102K-T	B	87.2/91.7
C350	4030004720	S.CER C2012 JB 1H 102K-T [EUR]	B	103.4/39.9
	4030004720	S.CER C2012 JB 1H 102K-T [FRA]		
	4030004720	S.CER C2012 JB 1H 102K-T [ESP]		
	4030004720	S.CER C2012 JB 1H 102K-T [USA]		
	4030004720	S.CER C2012 JB 1H 102K-T [ITR]		
	4030004720	S.CER C2012 JB 1H 102K-T [UK]		
	4030004720	S.CER C2012 JB 1H 102K-T [KOR]		
	4030004720	S.CER C2012 JB 1H 102K-T [CHN]		
C351	4030004720	S.CER C2012 JB 1H 102K-T [EUR]	B	106.2/39.9
	4030004720	S.CER C2012 JB 1H 102K-T [FRA]		
	4030004720	S.CER C2012 JB 1H 102K-T [ESP]		
	4030004720	S.CER C2012 JB 1H 102K-T [USA]		
	4030004720	S.CER C2012 JB 1H 102K-T [ITR]		
	4030004720	S.CER C2012 JB 1H 102K-T [UK]		
	4030004720	S.CER C2012 JB 1H 102K-T [KOR]		
	4030004720	S.CER C2012 JB 1H 102K-T [CHN]		
C354	4030004720	S.CER C2012 JB 1H 102K-T [EUR]	B	89.2/39.9
	4030004720	S.CER C2012 JB 1H 102K-T [FRA]		
	4030004720	S.CER C2012 JB 1H 102K-T [ESP]		
	4030004720	S.CER C2012 JB 1H 102K-T [USA]		
	4030004720	S.CER C2012 JB 1H 102K-T [ITR]		
	4030004720	S.CER C2012 JB 1H 102K-T [UK]		
	4030004720	S.CER C2012 JB 1H 102K-T [KOR]		
	4030004720	S.CER C2012 JB 1H 102K-T [CHN]		
C356	4030004720	S.CER C2012 JB 1H 102K-T [EUR]	B	97.5/11.0
	4030004720	S.CER C2012 JB 1H 102K-T [FRA]		
	4030004720	S.CER C2012 JB 1H 102K-T [ESP]		
	4030004720	S.CER C2012 JB 1H 102K-T [USA]		
	4030004720	S.CER C2012 JB 1H 102K-T [ITR]		
	4030004720	S.CER C2012 JB 1H 102K-T [UK]		
	4030004720	S.CER C2012 JB 1H 102K-T [KOR]		
	4030004720	S.CER C2012 JB 1H 102K-T [CHN]		
C357	4030004720	S.CER C2012 JB 1H 102K-T [EUR]	B	94.8/11.0
	4030004720	S.CER C2012 JB 1H 102K-T [FRA]		
	4030004720	S.CER C2012 JB 1H 102K-T [ESP]		
	4030004720	S.CER C2012 JB 1H 102K-T [USA]		
	4030004720	S.CER C2012 JB 1H 102K-T [ITR]		
	4030004720	S.CER C2012 JB 1H 102K-T [UK]		
	4030004720	S.CER C2012 JB 1H 102K-T [KOR]		
	4030004720	S.CER C2012 JB 1H 102K-T [CHN]		

Eqv.= This component is equivalent to the REF No. component listed above, and may be substituted on parts orders and repairs.

[PA UNIT]

REF NO.	PARTS NO.	DESCRIPTION	M.	H/V LOCATION
C358	4030006860	S.CER C1608 JB 1H 102K-T [EUR]	B	90.1/91.7
	4030006860	S.CER C1608 JB 1H 102K-T [FRA]		
	4030006860	S.CER C1608 JB 1H 102K-T [ESP]		
	4030006860	S.CER C1608 JB 1H 102K-T [USA]		
	4030006860	S.CER C1608 JB 1H 102K-T [ITR]		
	4030006860	S.CER C1608 JB 1H 102K-T [UK]		
	4030006860	S.CER C1608 JB 1H 102K-T [KOR]		
	4030006860	S.CER C1608 JB 1H 102K-T [CHN]		
C359	4030006860	S.CER C1608 JB 1H 102K-T [EUR]	B	94.9/107.4
	4030006860	S.CER C1608 JB 1H 102K-T [FRA]		
	4030006860	S.CER C1608 JB 1H 102K-T [ESP]		
	4030006860	S.CER C1608 JB 1H 102K-T [USA]		
	4030006860	S.CER C1608 JB 1H 102K-T [ITR]		
	4030006860	S.CER C1608 JB 1H 102K-T [UK]		
	4030006860	S.CER C1608 JB 1H 102K-T [KOR]		
	4030006860	S.CER C1608 JB 1H 102K-T [CHN]		
C360	4030006860	S.CER C1608 JB 1H 102K-T [EUR]	B	85.1/107.4
	4030006860	S.CER C1608 JB 1H 102K-T [FRA]		
	4030006860	S.CER C1608 JB 1H 102K-T [ESP]		
	4030006860	S.CER C1608 JB 1H 102K-T [USA]		
	4030006860	S.CER C1608 JB 1H 102K-T [ITR]		
	4030006860	S.CER C1608 JB 1H 102K-T [UK]		
	4030006860	S.CER C1608 JB 1H 102K-T [KOR]		
	4030006860	S.CER C1608 JB 1H 102K-T [CHN]		
C403	4030006860	S.CER C1608 JB 1H 102K-T	B	89.6/133.4
C404	4030006860	S.CER C1608 JB 1H 102K-T	B	151.7/71.5
C405	4030011740	S.CER GRM32N2C2H201JV01L (GRM42-2 CH)	T	145.4/105.7
C406	4030006860	S.CER C1608 JB 1H 102K-T	B	132.4/129.7
C408	4030018040	S.CER ERF22X 6C2H 180J D01L	B	134.2/93.0
C409	4030018040	S.CER ERF22X 6C2H 180J D01L	B	145.4/93.0
C410	4030018260	S.CER ERF22X 6C2H 150J D01L	B	145.4/96.4
C411	4030018260	S.CER ERF22X 6C2H 150J D01L	B	134.2/96.4
C412	4030018770	S.CER C3216 CH 2J 102J-T	T	136.0/111.5
C413	4030018770	S.CER C3216 CH 2J 102J-T	T	139.9/102.8
C415	4030018410	S.CER ERF22X 6C2H 2R0C D01L	T	143.1/139.4
C416	4030006880	S.CER C1608 JB 1H 472K-T	T	103.1/96.7
C417	4030018040	S.CER ERF22X 6C2H 180J D01L	T	139.2/136.2
C418	4030011120	S.CER GRM31M2C2H100JV01L (GRM42-6 CH)	B	134.1/134.2
C419	4030011020	S.CER GRM31M4C2H1R0CY21L (GRM42-6 CK)	B	132.6/138.3
C420	4030011080	S.CER GRM31M2C2H6R0DV01L (GRM42-6 CH)	B	129.2/139.5
C421	4030011020	S.CER GRM31M4C2H1R0CY21L (GRM42-6 CK)	B	120.6/136.8
C422	4030011120	S.CER GRM31M2C2H100JV01L (GRM42-6 CH)	B	121.7/141.1
C423	4030007090	S.CER C1608 CH 1H 470J-T	B	127.8/131.7
C425	4030011180	S.CER GRM31M2C2H220JV01L (GRM42-6 CH)	T	121.6/137.4
C426	4030006860	S.CER C1608 JB 1H 102K-T	B	106.8/133.9
C427	4030011020	S.CER GRM31M4C2H1R0CY21L (GRM42-6 CK)	B	102.1/139.6
C428	4030011090	S.CER GRM31M2C2H7R0DV01L (GRM42-6 CH)	T	97.0/138.1
C429	4030017940	S.CER ERF22X 6C2H 680J D01L	T	92.3/136.9
C430	4030019410	S.CER GRM31A7U2J471JW31D	B	94.3/138.1
C431	4030011070	S.CER GRM31M2C2H5R0CY21L (GRM42-6 CH)	T	86.9/133.8
C432	4030004820	S.CER C2012 CH 1H 050C-T	B	99.2/139.3
C433	4030011090	S.CER GRM31M2C2H7R0DV01L (GRM42-6 CH)	T	76.1/132.2
C434	4030006860	S.CER C1608 JB 1H 102K-T	B	90.0/124.9
C435	4030006860	S.CER C1608 JB 1H 102K-T	B	97.2/127.8
C436	4030006860	S.CER C1608 JB 1H 102K-T	T	98.4/130.9
C438	4030006880	S.CER C1608 JB 1H 471K-T	B	90.8/134.1
C439	4030006860	S.CER C1608 JB 1H 102K-T	B	92.9/133.2
C440	4030004710	S.CER C2012 JB 1H 471K-T	B	103.6/135.6
C441	4030011090	S.CER GRM31M2C2H7R0DV01L (GRM42-6 CH)	T	137.6/140.4
C444	4030006860	S.CER C1608 JB 1H 102K-T	B	59.3/117.9
C445	4030011090	S.CER GRM31M2C2H7R0DV01L (GRM42-6 CH)	B	109.8/139.2
C452	4030007020	S.CER C1608 CH 1H 120J-T	B	87.3/119.3
C453	4030006860	S.CER C1608 JB 1H 102K-T	T	63.9/117.3
C456	4030009350	S.CER C1608 CH 1H 3R5B-T	B	78.2/118.4
C458	4030006860	S.CER C1608 JB 1H 102K-T	T	73.8/113.1
C461	4030011600	S.CER C1608 JB 1E 104K-T	B	68.9/113.4
C462	4030011600	S.CER C1608 JB 1E 104K-T	B	77.1/110.8
C463	4030006860	S.CER C1608 JB 1H 102K-T	B	79.7/109.6
C464	4030011600	S.CER C1608 JB 1E 104K-T	B	77.7/106.0
C465	4030011600	S.CER C1608 JB 1E 104K-T	B	67.8/109.0
C466	4030006860	S.CER C1608 JB 1H 102K-T	B	77.7/104.7
C467	4030006860	S.CER C1608 JB 1H 102K-T	B	67.8/107.7
C468	4030007020	S.CER C1608 CH 1H 120J-T	B	73.7/101.1
C470	4030011600	S.CER C1608 JB 1E 104K-T	B	77.8/101.8
C471	4030006860	S.CER C1608 JB 1H 102K-T	B	77.8/100.5
C472	4030009500	S.CER C1608 CH 1H 0R5B-T	B	69.8/105.2
C473	4030007040	S.CER C1608 CH 1H 180J-T	B	69.7/104.0
C474	4030009530	S.CER C1608 CH 1H 030B-T	B	67.8/101.8
C475	4030006860	S.CER C1608 JB 1H 102K-T	B	66.6/98.9
C476	4030006860	S.CER C1608 JB 1H 102K-T	B	68.0/111.3

[PA UNIT]

REF NO.	PARTS NO.	DESCRIPTION	M.	H/V LOCATION
C504	4030017960	S.CER ERF22X 6C2H 330J D01L	T	111.8/122.1
C505	4030011040	S.CER GRM31M4C2H2R0CY21L (GRM42-6 CK)	B	114.4/125.4
C506	4030011120	S.CER GRM31M2C2H100JV01L (GRM42-6 CH)	B	118.3/125.6
C507	4030011040	S.CER GRM31M4C2H2R0CY21L (GRM42-6 CK)	B	113.9/131.5
C508	4030011070	S.CER GRM31M2C2H5R0CY21L (GRM42-6 CH)	B	110.4/132.9
C509	4030007150	S.CER C1608 CH 1H 151J-T	B	110.2/121.5
C511	4030018770	S.CER C3216 CH 2J 102J-T	T	109.6/125.5
C513	4030006860	S.CER C1608 JB 1H 102K-T	B	97.1/117.6
C514	4030011170	S.CER GRM31M2C2H180JV01L (GRM42-6 CH)	T	98.4/118.1
C515	4030018770	S.CER C3216 CH 2J 102J-T	T	96.9/120.4
C516	4030011100	S.CER GRM31M2C2H8R0DV01L (GRM42-6 CH)	T	88.2/124.1
C517	4030004880	S.CER C2012 CH 1H 120J-T	B	92.6/115.2
C518	4030018770	S.CER C3216 CH 2J 102J-T	B	94.1/121.5
C519	4030011190	S.CER GRM31M2C2H270JV01L (GRM42-6 CH)	T	86.1/124.1
C520	4030004870	S.CER C2012 CH 1H 100D-T	B	93.4/112.5
C521	4030011290	S.CER GRM31M2C2H240JV01L (GRM42-6 CH)	T	81.3/124.0
C522	4030006850	S.CER C1608 JB 1H 471K-T	T	96.4/107.8
C523	4030006860	S.CER C1608 JB 1H 102K-T	T	79.3/119.1
C524	4030006910	S.CER C1608 CH 1H 0R5C-T	T	79.9/121.0
C525	4030004720	S.CER C2012 JB 1H 102K-T	T	86.7/112.2
C526	4030007150	S.CER C1608 CH 1H 151J-T	B	113.4/121.5
C527	4030007150	S.CER C1608 CH 1H 151J-T	B	111.1/127.8
C528	4030006860	S.CER C1608 JB 1H 102K-T	B	96.2/114.5
C530	4030011230	S.CER GRM31M2C2H390JV01L (GRM42-6 CH)	T	120.8/113.4
C531	4030018770	S.CER C3216 CH 2J 102J-T	B	106.0/109.3
C532	4030018770	S.CER C3216 CH 2J 102J-T	B	103.1/109.2
C533	4030018770	S.CER C3216 CH 2J 102J-T	T	118.6/107.0
C534	4030017880	S.CER ERF22X 6C2H 560J D01L (GRM111)	B	112.7/103.9
C535	4030017880	S.CER ERF22X 6C2H 560J D01L (GRM111)	B	124.1/103.9
C536	4030017980	S.CER ERF22X 6C2H 470J D01L	T	101.0/110.8
C537	4030017940	S.CER ERF22X 6C2H 680J D01L	T	101.0/114.2
C538	4030017880	S.CER ERF22X 6C2H 560J D01L (GRM111)	T	131.2/117.6
C541	4030011060	S.CER GRM31M2C2H4R0CY21L (GRM42-6 CH)	T	125.1/123.8
C542	4030012480	S.CER GRM31M2C2H121JV01L (GRM42-6 CH)	T	123.4/128.8
C544	4030011730	S.CER GRM31M2C2H101JV01L (GRM42-6 CH)	T	129.9/123.5
C545	4030017940	S.CER ERF22X 6C2H 680J D01L	B	112.7/109.9
C551	4030006880	S.CER C1608 JB 1H 472K-T	T	80.1/117.1
C552	4030006860	S.CER C1608 JB 1H 102K-T	T	73.1/120.5
C553	4030006850	S.CER C1608 JB 1H 471K-T	T	69.4/114.8
C554	4030006860	S.CER C1608 JB 1H 102K-T	T	66.8/114.8
C555	4030006860	S.CER C1608 JB 1H 102K-T	T	63.1/111.7
C556	4030011600	S.CER C1608 JB 1E 104K-T	T	68.3/111.2
C557	4030006860	S.CER C1608 JB 1H 102K-T	T	70.8/108.5
C558	4030006860	S.CER C1608 JB 1H 102K-T	T	65.4/108.6
C559	4030006860	S.CER C1608 JB 1H 102K-T	T	66.1/103.5
C560	4030006860	S.CER C1608 JB 1H 102K-T	B	65.3/113.0
C561	4030006850	S.CER C1608 JB 1H 471K-T	T	70.1/105.0
C562	4030006860	S.CER C1608 JB 1H 102K-T	T	69.2/94.9
C563	4030006860	S.CER C1608 JB 1H 102K-T	T	62.3/106.1
C564	4030006860	S.CER C1608 JB 1H 102K-T	T	65.0/97.0
C565	4030006860	S.CER C1608 JB 1H 102K-T	T	62.3/103.0
C567	4030006860	S.CER C1608 JB 1H 102K-T	T	69.2/120.9
C601	4030011070	S.CER GRM31M2C2H5R0CY21L (GRM42-6 CH)	T	69.5/132.7
C602	4030011090	S.CER GRM31M2C2H7R0DV01L (GRM42-6 CH)	T	67.0/136.8
C701	4030017320	S.CER GRM21BB11H104KA01L (GRM40-034)	B	109.8/33.4
C702	4030006860	S.CER C1608 JB 1H 102K-T	B	107.7/33.2
C703	4030011600	S.CER C1608 JB 1E 104K-T	B	83.8/16.9
C704	4510004601	ELE 16 ME 1000 HC		
C705	4030011600	S.CER C1608 JB 1E 104K-T	B	79.0/16.9
C706	4510004601	ELE 16 ME 1000 HC		
C707	4030017320	S.CER GRM21BB11H104KA01L (GRM40-034)	B	67.1/18.6
C708	4030006900	S.CER C1608 JB 1H 103K-T	T	63.3/27.9
C709	4030006860	S.CER C1608 JB 1H 102K-T	T	63.3/26.6
C710	4030006850	S.CER C1608 JB 1H 471K-T	T	63.3/25.3
C711	4030007170	S.CER C1608 CH 1H 221J-T	T	63.3/24.0
C712	4030007170	S.CER C1608 CH 1H 221J-T	B	70.5/18.7
C713	4510004591	ELE 16 ME 470 HC		
C715	4030006860	S.CER C1608 JB 1H 102K-T	B	97.1/118.9
C718	4030011600	S.CER C1608 JB 1E 104K-T	B	128.4/19.3
C719	4030011600	S.CER C1608 JB 1E 104K-T	T	125.9/16.5
C720	4030011600	S.CER C1608 JB 1E 104K-T	B	130.6/38.8
C722	4030007130	S.CER C1608 CH 1H 101J-T	T	89.0/6.7
C723	4030007130	S.CER C1608 CH 1H 101J-T	T	78.3/3.1
C724	4030011340	S.CER C1608 CH 1H 471J-T	B	134.8/12.2
C725	4550007350	S.TAN F931C226MCMCMBMA	B	126.6/35.3
C726	4030006860	S.CER C1608 JB 1H 102K-T	B	91.4/111.1
C727	4030006860	S.CER C1608 JB 1H 102K-T	B	84.4/114.2
C728	4030006860	S.CER C1608 JB 1H 102K-T	B	91.3/112.6
C729	4030006860	S.CER C1608 JB 1H 102K-T	B	65.1/114.9
C732	4030011600	S.CER C1608 JB 1E 104K-T	T	71.9/2.6
C733	4030011600	S.CER C1608 JB 1E 104K-T	T	66.8/12.9
C734	4030006860	S.CER C1608 JB 1H 102K-T	B	63.6/1.9
C735	4030011600	S.CER C1608 JB 1E 104K-T	T	74.1/13.2
C736	4030011600	S.CER C1608 JB 1E 104K-T	B	67.4/1.9
C737	4030011600	S.CER C1608 JB 1E 104K-T	B	65.5/1.9
C738	4030011600	S.CER C1608 JB 1E 104K-T	B	68.2/14.5

Eqv.= This component is equivalent to the REF No. component listed above, and may be substituted on parts orders and repairs.

[PA UNIT]

REF NO.	PARTS NO.	DESCRIPTION	M.	H/V LOCATION
C739	4030011600	S.CER C1608 JB 1E 104K-T	B	69.8/14.5
C741	4030011600	S.CER C1608 JB 1E 104K-T	B	78.6/6.4
C742	4030011600	S.CER C1608 JB 1E 104K-T	T	69.4/12.9
C743	4030006860	S.CER C1608 JB 1H 102K-T	T	68.1/12.9
C744	4030011600	S.CER C1608 JB 1E 104K-T	T	70.7/12.9
C745	4030011600	S.CER C1608 JB 1E 104K-T	B	77.7/14.3
C746	4030011600	S.CER C1608 JB 1E 104K-T	B	76.3/15.1
C747	4030011600	S.CER C1608 JB 1E 104K-T	T	98.5/4.1
C749	4030011600	S.CER C1608 JB 1E 104K-T	T	96.7/6.4
C750	4030006880	S.CER C1608 JB 1H 472K-T	T	94.3/6.4
C751	4030006860	S.CER C1608 JB 1H 102K-T	T	95.5/6.4
C752	4030011600	S.CER C1608 JB 1E 104K-T	T	93.1/6.4
C753	4030006880	S.CER C1608 JB 1H 472K-T	B	59.9/10.7
C754	4030006860	S.CER C1608 JB 1H 102K-T	B	66.6/14.5
C755	4030006860	S.CER C1608 JB 1H 102K-T	B	58.5/119.2
C757	4030011600	S.CER C1608 JB 1E 104K-T	B	76.4/8.0
C759	4030006880	S.CER C1608 JB 1H 472K-T	T	72.8/13.2
C760	4030006880	S.CER C1608 JB 1H 472K-T	B	74.8/8.0
C761	4030006880	S.CER C1608 JB 1H 472K-T	B	73.2/8.0
C762	4030006880	S.CER C1608 JB 1H 472K-T	B	70.0/8.0
C763	4030006880	S.CER C1608 JB 1H 472K-T	B	71.6/8.0
C764	4030006880	S.CER C1608 JB 1H 472K-T	B	62.0/1.9
C765	4030011600	S.CER C1608 JB 1E 104K-T	B	69.0/1.9
C766	4030006860	S.CER C1608 JB 1H 102K-T	B	66.6/8.7
C781	4030006860	S.CER C1608 JB 1H 102K-T	T	73.1/90.1
C782	4030006900	S.CER C1608 JB 1H 103K-T	T	71.9/84.3
C783	4030006880	S.CER C1608 JB 1H 472K-T	T	71.9/83.1
C801	4030007070	S.CER C1608 CH 1H 330J-T	T	55.1/58.5
C802	4030009470	S.CER C1608 CH 1H R75C-T	T	53.8/58.4
C803	4030007100	S.CER C1608 CH 1H 560J-T	T	53.8/53.3
C804	4030007030	S.CER C1608 CH 1H 150J-T	T	56.2/52.5
C805	4030007080	S.CER C1608 CH 1H 390J-T	T	53.8/51.7
C806	4030006880	S.CER C1608 JB 1H 472K-T	B	47.1/39.8
C807	4030011600	S.CER C1608 JB 1E 104K-T	B	43.2/58.6
C808	4030011600	S.CER C1608 JB 1E 104K-T	B	43.2/44.6
C820	4030011600	S.CER C1608 JB 1E 104K-T	B	54.2/91.3
C821	4030006880	S.CER C1608 JB 1H 472K-T	B	53.6/99.3
C822	4030011510	S.CER GRM31M2C2H560JV01L (GRM42-6 CH)	B	42.3/21.9
C823	4030011190	S.CER GRM31M2C2H270JV01L (GRM42-6 CH)	B	33.0/18.3
C824	4030012480	S.CER GRM31M2C2H121JV01L (GRM42-6 CH)	B	25.2/17.1
C825	4030011240	S.CER GRM31M2C2H470JV01L (GRM42-6 CH)	B	17.9/15.7
C826	4030011550	S.CER GRM31M2C2H680JV01L (GRM42-6 CH)	B	11.2/19.9
C827	4030011510	S.CER GRM31M2C2H560JV01L (GRM42-6 CH)	B	8.8/19.9
C828	4030006880	S.CER C1608 JB 1H 472K-T	T	5.2/106.8
C829	4030011600	S.CER C1608 JB 1E 104K-T	T	2.6/106.8
C830	4030011210	S.CER GRM31M2C2H330JV01L (GRM42-6 CH)	B	22.5/17.1
C831	4030006880	S.CER C1608 JB 1H 472K-T	B	8.1/110.4
C832	4030006880	S.CER C1608 JB 1H 472K-T	B	51.6/95.5
C833	4030011730	S.CER GRM31M2C2H101JV01L (GRM42-6 CH)	B	27.6/17.1
C835	4030012480	S.CER GRM31M2C2H121JV01L (GRM42-6 CH)	B	16.7/107.2
C836	4030012480	S.CER GRM31M2C2H121JV01L (GRM42-6 CH)	B	12.6/107.9
C837	4030012480	S.CER GRM31M2C2H121JV01L (GRM42-6 CH)	B	12.6/105.8
C840	4030011600	S.CER C1608 JB 1E 104K-T	B	42.8/97.3
C841	4030006880	S.CER C1608 JB 1H 472K-T	B	46.1/98.5
C842	4030011730	S.CER GRM31M2C2H101JV01L (GRM42-6 CH)	B	39.0/106.8
C843	4010008160	CER HM13SJ SL 431J 500V		
C844	4030011730	S.CER GRM31M2C2H101JV01L (GRM42-6 CH)	B	25.9/102.9
C845	4030014460	S.CER GRM31M2C2H820JV01L (GRM42-6 CH)	B	19.7/91.9
C846	4010005370	CER HM11SJ SL 331J 500V		
C847	4010005930	CER HM11SJ SL 391J 500V		
C848	4030011190	S.CER GRM31M2C2H270JV01L (GRM42-6 CH)	B	12.6/98.3
C849	4030011180	S.CER GRM31M2C2H220JV01L (GRM42-6 CH)	B	12.6/96.2
C850	4010005930	CER HM11SJ SL 391J 500V		
C851	4030012480	S.CER GRM31M2C2H121JV01L (GRM42-6 CH)	B	20.3/112.1
C852	4030006880	S.CER C1608 JB 1H 472K-T	T	5.3/90.6
C853	4030011600	S.CER C1608 JB 1E 104K-T	T	2.6/90.6
C854	4030006880	S.CER C1608 JB 1H 472K-T	B	7.8/92.7
C855	4030011730	S.CER GRM31M2C2H101JV01L (GRM42-6 CH)	B	28.0/104.9
C856	4030011510	S.CER GRM31M2C2H560JV01L (GRM42-6 CH)	B	31.2/105.5
C857	4030012480	S.CER GRM31M2C2H121JV01L (GRM42-6 CH)	B	43.1/108.4
C858	4030011730	S.CER GRM31M2C2H101JV01L (GRM42-6 CH)	B	20.3/110.0
C860	4030011600	S.CER C1608 JB 1E 104K-T	B	43.4/83.8
C861	4030006880	S.CER C1608 JB 1H 472K-T	B	46.6/83.8
C863	4030011270	S.CER GRM31M2C2H200JV01L (GRM42-6 CH)	B	37.5/93.5
C864	4030011510	S.CER GRM31M2C2H560JV01L (GRM42-6 CH)	B	28.5/82.6
C865	4030011110	S.CER GRM31M2C2H9R0DV01L (GRM42-6 CH)	B	29.5/78.6
C866	4030011230	S.CER GRM31M2C2H390JV01L (GRM42-6 CH)	B	24.5/78.1
C868	4030011240	S.CER GRM31M2C2H470JV01L (GRM42-6 CH)	B	26.9/78.6

M.=Mounted side (T: Mounted on the Top side, B: Mounted on the Bottom side) S.=Surface mount

[PA UNIT]

REF NO.	PARTS NO.	DESCRIPTION	M.	H/V LOCATION
C869	4030011180	S.CER GRM31M2C2H220JV01L (GRM42-6 CH)	B	10.3/83.6
C870	4030011190	S.CER GRM31M2C2H270JV01L (GRM42-6 CH)	B	17.0/77.7
C871	4030006880	S.CER C1608 JB 1H 472K-T	T	5.2/74.5
C872	4030011600	S.CER C1608 JB 1E 104K-T	T	2.5/74.5
C873	4030011070	S.CER GRM31M2C2H5R0CY21L (GRM42-6 CH)	B	33.2/92.6
C874	4030006880	S.CER C1608 JB 1H 472K-T	B	9.0/74.5
C876	4030011160	S.CER GRM31M2C2H150JV01L (GRM42-6 CH)	B	22.1/77.5
C880	4030011600	S.CER C1608 JB 1E 104K-T	B	43.4/69.1
C881	4030006880	S.CER C1608 JB 1H 472K-T	B	47.0/69.1
C882	4010007590	CER HM15SJ SL 681J 500V		
C883	4010007590	CER HM15SJ SL 681J 500V		
C884	4010005930	CER HM11SJ SL 391J 500V		
C885	4320000320	DIP DM20C 222J5		
C886	4030012480	S.CER GRM31M2C2H121JV01L (GRM42-6 CH)	B	31.5/57.2
C887	4030011730	S.CER GRM31M2C2H101JV01L (GRM42-6 CH)	B	33.9/57.2
C889	4030014460	S.CER GRM31M2C2H820JV01L (GRM42-6 CH)	B	18.0/65.3
C890	4320001250	DIP DM19C 162J5		
C893	4030006880	S.CER C1608 JB 1H 472K-T	T	5.3/58.4
C894	4030011600	S.CER C1608 JB 1E 104K-T	T	2.6/58.4
C900	4030011600	S.CER C1608 JB 1E 104K-T	B	44.1/54.4
C901	4030006880	S.CER C1608 JB 1H 472K-T	B	46.9/54.4
C902	4010005870	CER HM95SJ SL 221J 500V		
C903	4030011190	S.CER GRM31M2C2H270JV01L (GRM42-6 CH)	B	30.9/42.7
C904	4030014460	S.CER GRM31M2C2H820JV01L (GRM42-6 CH)	B	28.4/42.7
C905	4010005870	CER HM95SJ SL 221J 500V		
C906	4030011510	S.CER GRM31M2C2H560JV01L (GRM42-6 CH)	B	17.0/44.0
C907	4030011510	S.CER GRM31M2C2H560JV01L (GRM42-6 CH)	B	10.8/49.5
C908	4030006880	S.CER C1608 JB 1H 472K-T	T	5.3/42.2
C909	4030011600	S.CER C1608 JB 1E 104K-T	T	2.6/42.2
C920	4030011600	S.CER C1608 JB 1E 104K-T	B	43.2/25.1
C921	4030006880	S.CER C1608 JB 1H 472K-T	B	47.1/25.4
C922	4010007590	CER HM15SJ SL 681J 500V		
C923	4030011730	S.CER GRM31M2C2H101JV01L (GRM42-6 CH)	B	31.4/27.3
C924	4010006410	CER HM13SJ SL 471J 500V		
C925	4030014460	S.CER GRM31M2C2H820JV01L (GRM42-6 CH)	B	15.8/29.5
C926	4010006410	CER HM13SJ SL 471J 500V		
C927	4010005930	CER HM11SJ SL 391J 500V		
C928	4010005930	CER HM11SJ SL 391J 500V		
C929	4030006880	S.CER C1608 JB 1H 472K-T	T	5.3/25.9
C930	4030011600	S.CER C1608 JB 1E 104K-T	T	2.6/25.9
C931	4030014460	S.CER GRM31M2C2H820JV01L (GRM42-6 CH)	B	34.1/27.3
C932	4030011730	S.CER GRM31M2C2H101JV01L (GRM42-6 CH)	B	33.3/32.4
C933	4030011730	S.CER GRM31M2C2H101JV01L (GRM42-6 CH)	B	29.7/30.9
C940	4030011600	S.CER C1608 JB 1E 104K-T	B	43.6/11.1
C941	4030006880	S.CER C1608 JB 1H 472K-T	B	43.6/14.2
C942	4030014460	S.CER GRM31M2C2H820JV01L (GRM42-6 CH)	B	39.5/119.2
C943	4030011210	S.CER GRM31M2C2H330JV01L (GRM42-6 CH)	B	28.9/111.7
C944	4030014460	S.CER GRM31M2C2H820JV01L (GRM42-6 CH)	B	24.7/118.4
C945	4030011170	S.CER GRM31M2C2H180JV01L (GRM42-6 CH)	B	16.5/118.1
C947	4030006880	S.CER C1608 JB 1H 472K-T	T	5.3/9.9
C948	4030011600	S.CER C1608 JB 1E 104K-T	T	2.6/9.9
C949	4030011050	S.CER GRM31M3C2H3R0CY21L (GRM42-6 CJ)	B	28.9/109.6
C960	4030010760	S.CER C1608 CH 1H 331J-T	T	18.2/130.2
C961	4030011600	S.CER C1608 JB 1E 104K-T	B	45.1/134.1
C962	4030006880	S.CER C1608 JB 1H 472K-T	B	39.0/137.9
C963	4030006880	S.CER C1608 JB 1H 472K-T	B	38.7/126.3
C964	4610002120	S.TRI TZB4Z100EB10R00 (TZBX4Z100BE110)	T	3.3/126.6
C966	4030006880	S.CER C1608 JB 1H 472K-T	B	21.3/131.2
C968	4030011340	S.CER C1608 CH 1H 471J-T	B	31.0/130.6
C969	4030011340	S.CER C1608 CH 1H 471J-T	B	31.0/133.7
C970	4030010760	S.CER C1608 CH 1H 331J-T	B	22.0/132.8
C971	4030011340	S.CER C1608 CH 1H 471J-T	B	35.8/133.7
C972	4030011790	S.CER GRM55RF52A684ZD01L (GRM44-1)	B	3.4/136.4
C973	4030007090	S.CER C1608 CH 1H 470J-T	B	8.4/129.8
C979	4030006880	S.CER C1608 JB 1H 472K-T	T	51.8/38.6
C987	4030006880	S.CER C1608 JB 1H 472K-T	B	28.9/3.3
C988	4030006880	S.CER C1608 JB 1H 472K-T	B	26.3/3.3
C989	4030006880	S.CER C1608 JB 1H 472K-T	B	25.0/2.6
C990	4030006880	S.CER C1608 JB 1H 472K-T	T	20.6/3.0
C991	4030006880	S.CER C1608 JB 1H 472K-T	T	20.6/4.2
C992	4030006880	S.CER C1608 JB 1H 472K-T	T	20.6/5.4
C993	4030006880	S.CER C1608 JB 1H 472K-T	T	20.6/6.6
C994	4030011600	S.CER C1608 JB 1E 104K-T	B	29.5/6.2
C995	4030006880	S.CER C1608 JB 1H 472K-T	B	23.7/3.4
C996	4030007090	S.CER C1608 CH 1H 470J-T	T	20.6/9.0
C997	4030007090	S.CER C1608 CH 1H 470J-T	T	20.6/7.8
C998	4030007090	S.CER C1608 CH 1H 470J-T	T	20.6/10.2
C999	4030006860	S.CER C1608 JB 1H 102K-T	T	56.9/9.5
C1000	4030006860	S.CER C1608 JB 1H 102K-T	B	55.6/5.1
C1001	4030011600	S.CER C1608 JB 1E 104K-T	B	51.7/1.7
C1002	4030006880	S.CER C1608 JB 1H 472K-T	B	27.6/2.6
C1003	4030011600	S.CER C1608 JB 1E 104K-T	T	49.8/7.6

Eqv.= This component is equivalent to the REF No. component listed above, and may be substituted on parts orders and repairs.

[PA UNIT]

REF NO.	PARTS NO.	DESCRIPTION	M.	H/V LOCATION
C1004	4030011510	S.CER GRM31M2C2H560JV01L (GRM42-6 CH)	B	39.9/21.9
C1005	4030011550	S.CER GRM31M2C2H680JV01L (GRM42-6 CH)	B	16.8/91.9
C1006	4030014460	S.CER GRM31M2C2H820JV01L (GRM42-6 CH)	B	39.0/109.2
C1007	4030011550	S.CER GRM31M2C2H680JV01L (GRM42-6 CH)	B	18.1/62.1
C1009	4030011510	S.CER GRM31M2C2H560JV01L (GRM42-6 CH)	B	20.6/118.7
C1010	4030014460	S.CER GRM31M2C2H820JV01L (GRM42-6 CH)	B	27.1/119.6
C1121	4010006410	CER HM13SJ SL 471J 500V		
RL701	6330001550	REL JV-12-KT		
RL801	6330001721	REL ATN207-K1		
RL820	6330001721	REL ATN207-K1		
RL821	6330001721	REL ATN207-K1		
RL840	6330001721	REL ATN207-K1		
RL841	6330001721	REL ATN207-K1		
RL860	6330001721	REL ATN207-K1		
RL861	6330001721	REL ATN207-K1		
RL880	6330001721	REL ATN207-K1		
RL881	6330001721	REL ATN207-K1		
RL900	6330001721	REL ATN207-K1		
RL901	6330001721	REL ATN207-K1		
RL920	6330001721	REL ATN207-K1		
RL921	6330001721	REL ATN207-K1		
RL940	6330001721	REL ATN207-K1		
RL941	6330001721	REL ATN207-K1		
J2	6510023512	S.CON 28FLT-SM2-TB(LF)(SN)(M)	T	80.1/6.0
J980	6510023512	S.CON 28FLT-SM2-TB(LF)(SN)(M)	T	63.7/6.0
F1	5220000341	HOL FHA010-03F		
F2	5210000940	FUS 1205		
W701	8900013900	CAB OPC-1455		
W702	8900013910	CAB OPC-1456		
W801	7120000480	S.JUM MJP-0.4-T	B	8.3/101.0
W901	7120000480	S.JUM MJP-0.4-T	T	56.7/22.0
EP202	6910012350	S.BEA MMZ1608Y 102BT	B	136.0/51.4
EP703	6910012350	S.BEA MMZ1608Y 102BT	B	142.6/13.9
EP741	6910012350	S.BEA MMZ1608Y 102BT	B	76.4/12.0
EP742	6910012350	S.BEA MMZ1608Y 102BT	B	77.8/11.3
EP743	6910012350	S.BEA MMZ1608Y 102BT	B	59.8/99.6
EP747	6910012350	S.BEA MMZ1608Y 102BT	T	65.1/9.7
EP748	6910012350	S.BEA MMZ1608Y 102BT	T	63.8/9.7
EP751	6910012350	S.BEA MMZ1608Y 102BT	T	74.1/9.6
EP752	6910012350	S.BEA MMZ1608Y 102BT	B	63.4/5.3
EP753	6910012350	S.BEA MMZ1608Y 102BT	T	66.4/9.7
EP754	6910012350	S.BEA MMZ1608Y 102BT	B	59.4/115.9
EP756	6910012350	S.BEA MMZ1608Y 102BT	T	68.6/2.6
EP758	6910012350	S.BEA MMZ1608Y 102BT	T	70.4/9.6
EP759	6910012350	S.BEA MMZ1608Y 102BT	T	69.1/9.6
EP760	6910012350	S.BEA MMZ1608Y 102BT	T	60.7/10.0
EP761	6910012350	S.BEA MMZ1608Y 102BT	T	62.6/9.7
EP762	6910012350	S.BEA MMZ1608Y 102BT	B	61.0/4.6
EP763	6910012350	S.BEA MMZ1608Y 102BT	B	63.4/105.7
EP767	6910012350	S.BEA MMZ1608Y 102BT	B	76.4/5.2
EP772	6910012350	S.BEA MMZ1608Y 102BT	T	96.5/3.8
EP774	6910012350	S.BEA MMZ1608Y 102BT	T	72.8/9.6
EP775	6910012350	S.BEA MMZ1608Y 102BT	B	74.8/5.2
EP776	6910012350	S.BEA MMZ1608Y 102BT	B	73.2/5.2
EP777	6910012350	S.BEA MMZ1608Y 102BT	B	70.0/5.2
EP778	6910012350	S.BEA MMZ1608Y 102BT	B	71.6/5.2
EP779	6910012350	S.BEA MMZ1608Y 102BT	B	68.2/5.3

M.=Mounted side (T: Mounted on the Top side, B: Mounted on the Bottom side) S.=Surface mount

[DRIVER UNIT]

REF NO.	PARTS NO.	DESCRIPTION	M.	H/V LOCATION
Q504	1590003061	S.FET PD55015-E	T	20.0/9.7
R102	7070000271	RES ERG1SJ 101 (100)		
R103	7030000020	S.RES MCR10EZJH 1 (010)	T	14.3/4.1
C101	4030004750	S.CER C2012 JB 1H 103K-T	T	24.6/18.2
C102	4030011230	S.CER GRM31M2C2H390JV01L (GRM42-6 CH)	T	10.2/4.3
J101	6910016830	CON IMSA-9230B-1-04Z149-PT1		
J102	6910016830	CON IMSA-9230B-1-04Z149-PT1		
J103	6910016830	CON IMSA-9230B-1-04Z149-PT1		
J104	6910016830	CON IMSA-9230B-1-04Z149-PT1		
J107	6910016830	CON IMSA-9230B-1-04Z149-PT1		

[DISPLAY UNIT]

REF NO.	PARTS NO.	DESCRIPTION	M.	H/V LOCATION
IC1	6910016731	S.DC XC9504B092AR-G	B	44.5/9.4
IC101	1180001072	S.IC TA7805F(TE16L1NQ)	B	90.3/6.9
IC151	1180002202	S.IC RN5RZ33BA-TR-FE	B	99.9/4.8
IC301	1110002751	S.IC TA75S01F(TE85RF)	B	113.8/7.6
IC506	1120003010	S.IC AN2533FH-V	B	69.0/38.5
IC651	1110005420	S.IC BA15532F-E2	B	4.1/25.6
IC2003	1140013140	S.IC HD643380205B68HV(SX-2427C)	B	93.0/26.3
IC2007	1110005822	S.IC R3112N281A-TR-FE	B	108.7/46.9
Q1	1550000090	S.FET RSQ035P03TR	B	39.5/9.9
Q51	1560001330	S.FET RSR025N03	B	52.1/10.6
Q301	1560001290	S.FET 2SK3065 T100	T	110.8/31.4
Q302	1590003940	S.TRA RN1105(TE85LF)	T	116.7/10.2
Q303	1590004030	S.TRA KRX204U-RTK/P	T	113.1/11.6
Q651	1590001650	S.TRA XP4601(TX)	B	10.6/28.8
Q652	1590001650	S.TRA XP4601(TX)	B	11.1/20.6
Q653	1590001650	S.TRA XP4601(TX)	B	10.7/26.2
Q654	1590001650	S.TRA XP4601(TX)	B	11.1/17.0
Q701	1530004140	S.TRA L2SC4081RT1G <SLVJ>	T	19.1/50.3
Q721	1530004140	S.TRA L2SC4081RT1G <SLVJ>	T	22.0/5.9
Q741	1530004140	S.TRA L2SC4081RT1G <SLVJ>	T	94.0/50.1
Q761	1530004140	S.TRA L2SC4081RT1G <SLVJ>	T	104.2/50.1
Q771	1530004140	S.TRA L2SC4081RT1G <SLVJ>	T	18.4/25.2
Q781	1530004140	S.TRA L2SC4081RT1G <SLVJ>	T	5.3/23.6
Q802	1520000460	S.TRA 2SB1132 T100 R	B	58.8/21.6
Q851	1590004770	S.FET CPH3455-TL-H	B	39.9/18.4
Q2001	1590003940	S.TRA RN1105(TE85LF)	B	81.6/23.8
Q2002	1590001870	S.TRA DTA114EE TL	B	80.2/29.8
Q2003	1590003480	S.TRA DTC114TE TL	B	82.2/32.3
D1	1790000971	S.DIO MA2J7290GL	B	36.9/10.2
D51	1750000731	S.DIO MA2SD100GL	B	51.0/8.1
D301	1790001251	S.DIO MA2S1110GL	B	111.1/32.1
D302	1790001521	S.ZEN MAZ8075GLL	B	109.9/7.6
D601	1750000951	S.DIO MA2J7320GL	B	51.6/39.9
D602	1750000951	S.DIO MA2J7320GL	B	53.4/39.9
D801	1730002341	S.ZEN MAZ8047GML	B	35.0/40.5
D802	1730002341	S.ZEN MAZ8047GML	B	39.8/25.9
D803	1730002341	S.ZEN MAZ8047GML	B	39.5/22.9
D804	1730002341	S.ZEN MAZ8047GML	B	42.1/22.9
D2001	1750000951	S.DIO MA2J7320GL	T	107.5/26.5
D2002	1790001670	S.DIO RB706F-40T106	B	76.6/16.9
D2003	1790001670	S.DIO RB706F-40T106	T	116.5/36.8
D2004	1750000370	S.DIO DA221 TL	T	100.6/41.8
D2005	1750000370	S.DIO DA221 TL	B	101.7/42.8
D2006	1750000370	S.DIO DA221 TL	B	107.3/5.9
X501	6050012150	S.XTA CR-806 SMD-49TA 4.433619 MHz<KDS>	[EUR] B	87.0/43.5
	6050012150	S.XTA CR-806 SMD-49TA 4.433619 MHz<KDS>	[FRA]	
	6050012150	S.XTA CR-806 SMD-49TA 4.433619 MHz<KDS>	[ESP]	
	6050012140	S.XTA CR-805 SMD-49TA 3.579545 MHz<KDS>	[USA]	
	6050012150	S.XTA CR-806 SMD-49TA 4.433619 MHz<KDS>	[ITR]	
	6050012150	S.XTA CR-806 SMD-49TA 4.433619 MHz<KDS>	[UK]	
	6050012140	S.XTA CR-805 SMD-49TA 3.579545 MHz<KDS>	[KOR]	
	6050012150	S.XTA CR-806 SMD-49TA 4.433619 MHz<KDS>	[AUS]	
	6050012150	S.XTA CR-806 SMD-49TA 4.433619 MHz<KDS>	[CHN]	
X2001	6050011550	S.XTA CR-747 SMD-49TA 9.8304 MHz<KDS>	B	106.5/27.0
L1	6190001561	S.COI CDRH5D18NP-101NCI	B	68.4/6.4
L2	6190001561	S.COI CDRH5D18NP-101NCI	B	34.6/5.2
L3	6200002041	S.COI NLV25T-101J	B	30.7/10.4
L51	6190001561	S.COI CDRH5D18NP-101NCI	B	56.0/6.2
L53	6200002041	S.COI NLV25T-101J	B	60.9/11.0
L101	6200001831	S.COI NLV32T-100J	B	96.0/11.6
L151	6200001831	S.COI NLV32T-100J	B	96.0/8.6
L152	6200001831	S.COI NLV32T-100J	B	100.6/11.4
L251	6200003950	S.COI HF50ACC 322513-T	B	145.8/44.0
L252	6200003950	S.COI HF50ACC 322513-T	B	145.2/50.9
L301	6200002041	S.COI NLV25T-101J	B	109.7/16.8
L302	6200005011	S.COI NLV25T-100J	T	112.6/24.1
L303	6200002041	S.COI NLV25T-101J	T	112.1/20.4
L306	6200003261	S.COI NLV32T-101J	T	109.9/25.6
L307	6200002041	S.COI NLV25T-101J	T	115.4/26.6
L309	6200002041	S.COI NLV25T-101J	T	115.4/24.1
L310	6200002041	S.COI NLV25T-101J	T	115.5/21.6
L312	6200002041	S.COI NLV25T-101J	T	115.5/19.1
L313	6200002041	S.COI NLV25T-101J	T	115.8/16.3
L505	6200005521	S.COI NLV25T-470J	B	71.2/47.9
L506	6200005011	S.COI NLV25T-100J	B	68.0/20.2
L507	6200005011	S.COI NLV25T-100J	B	50.3/29.0
L508	6200005011	S.COI NLV25T-100J	B	49.3/24.4
L509	6200005011	S.COI NLV25T-100J	B	17.4/35.7
L601	6200002041	S.COI NLV25T-101J	B	70.6/25.2
L602	6200005011	S.COI NLV25T-100J	B	53.5/36.2
L603	6200005011	S.COI NLV25T-100J	B	51.0/43.3
L604	6200005011	S.COI NLV25T-100J	B	53.5/43.3
L605	6200005011	S.COI NLV25T-100J	B	50.9/36.2
L651	6200002041	S.COI NLV25T-101J	B	19.1/42.8
L701	6200002041	S.COI NLV25T-101J	B	21.1/37.5
L702	6200002041	S.COI NLV25T-101J	B	65.4/11.0
L703	6200002041	S.COI NLV25T-101J	B	28.0/11.3

Eqv.= This component is equivalent to the REF No. component listed above, and may be substituted on parts orders and repairs.

M.=Mounted side (T: Mounted on the Top side, B: Mounted on the Bottom side) S.=Surface mount

[DISPLAY UNIT]

REF NO.	PARTS NO.	DESCRIPTION	M.	H/V LOCATION
L801	6200005011	S.COI NLV25T-100J	B	63.5/17.0
L802	6200002041	S.COI NLV25T-101J	B	19.1/47.5
L851	6200003950	S.COI HF50ACC 322513-T	B	33.2/17.2
L852	6200003950	S.COI HF50ACC 322513-T	B	35.0/21.4
L853	6200002041	S.COI NLV25T-101J	B	34.4/26.6
L854	6200002041	S.COI NLV25T-101J	B	34.4/24.1
L855	6200003950	S.COI HF50ACC 322513-T	B	36.5/17.2
R1	7030008141	S.RES ERA3YKD 224V (220K)	B	33.5/9.7
R2	7030005671	S.RES ERA3YKD 393V (39K)	B	33.5/11.6
R3	7030008051	S.RES ERA3YKD 184V (180K)	B	42.6/6.4
R4	7030005050	S.RES ERJ2GEJ 103 X (10K)	B	40.9/6.8
R5	7030005050	S.RES ERJ2GEJ 103 X (10K)	B	40.9/7.7
R51	7030008141	S.RES ERA3YKD 224V (220K)	B	49.8/10.8
R52	7030007911	S.RES ERA3YKD 563V (56K)	B	48.6/10.8
R53	7030006561	S.RES ERA3YED 223V (22K)	B	46.6/11.8
R54	7030005050	S.RES ERJ2GEJ 103 X (10K)	B	48.0/8.4
R55	7030005050	S.RES ERJ2GEJ 103 X (10K)	B	48.9/8.4
R201	7030010040	S.RES ERJ2GEJ-JPW	B	109.7/38.1
R202	7030010040	S.RES ERJ2GEJ-JPW	B	109.7/39.1
R251	7030005120	S.RES ERJ2GEJ 102 X (1K)	B	136.6/49.6
R252	7030000300	S.RES MCR10EZHJ 220 (221)	B	133.9/47.3
R253	7030000300	S.RES MCR10EZHJ 220 (221)	B	141.3/51.5
R254	7030000300	S.RES MCR10EZHJ 220 (221)	B	133.9/49.1
R255	7030000300	S.RES MCR10EZHJ 220 (221)	T	142.6/51.4
R301	7030005120	S.RES ERJ2GEJ 102 X (1K)	B	113.3/32.1
R302	7030005050	S.RES ERJ2GEJ 103 X (10K)	T	114.0/30.5
R303	7030005120	S.RES ERJ2GEJ 102 X (1K)	B	111.1/33.4
R304	7030007300	S.RES ERJ2GEJ 332 X (3.3K)	B	112.0/33.4
R305	7030007300	S.RES ERJ2GEJ 332 X (3.3K)	B	113.3/33.0
R306	7030005120	S.RES ERJ2GEJ 102 X (1K)	T	114.9/11.0
R307	7030005050	S.RES ERJ2GEJ 103 X (10K)	B	111.3/8.4
R308	7030005230	S.RES ERJ2GEJ 334 X (330K)	B	113.8/5.4
R309	7030005310	S.RES ERJ2GEJ 124 X (120K)	B	112.0/5.4
R310	7030008010	S.RES ERJ2GEJ 123 X (12K)	B	110.2/5.4
R521	7030008370	S.RES ERJ2GEJ 561 X (560)	B	61.9/46.3
R522	7030010040	S.RES ERJ2GEJ-JPW	B	65.3/47.4
R523	7030010040	S.RES ERJ2GEJ-JPW	B	65.4/48.7
R524	7030010900	S.RES ERJ3GEYJ 750 V (75)	B	63.2/49.0
R528	7030010040	S.RES ERJ2GEJ-JPW	B	60.8/42.7
R529	7030005050	S.RES ERJ2GEJ 103 X (10K)	B	58.6/43.9
R530	7030005080	S.RES ERJ2GEJ 823 X (82K)	B	60.8/43.7
R531	7030009290	S.RES ERJ2GEJ 562 X (5.6K)	B	76.3/43.0
R532	7030005050	S.RES ERJ2GEJ 103 X (10K)	B	60.8/37.2
R533	7030010040	S.RES ERJ2GEJ-JPW	B	56.6/32.3
R534	7030010040	S.RES ERJ2GEJ-JPW	B	60.8/36.0
R536	7030010040	S.RES ERJ2GEJ-JPW	B	62.6/29.0
R537	7030010040	S.RES ERJ2GEJ-JPW	B	64.6/29.0
R538	7030010040	S.RES ERJ2GEJ-JPW	B	66.6/29.0
R539	7030005720	S.RES ERJ2GEJ 563 X (56K)	B	69.7/29.0
R540	7030010040	S.RES ERJ2GEJ-JPW	B	68.6/29.0
R541	7310004650	S.TRI EVM-2WSX80 B53 (502)	B	53.3/49.3
R544	7030010040	S.RES ERJ2GEJ-JPW	B	60.8/39.6
R545	7030005720	S.RES ERJ2GEJ 563 X (56K)	B	60.8/32.0
R546	7030010040	S.RES ERJ2GEJ-JPW	B	60.8/34.0
R547	7030010040	S.RES ERJ2GEJ-JPW	B	59.2/34.8
R548	7030010040	S.RES ERJ2GEJ-JPW	B	60.8/33.0
R549	7030010040	S.RES ERJ2GEJ-JPW	B	63.6/29.0
R550	7030010040	S.RES ERJ2GEJ-JPW	B	65.6/29.0
R551	7030010040	S.RES ERJ2GEJ-JPW	B	67.6/29.0
R553	7030010040	S.RES ERJ2GEJ-JPW	B	59.5/43.9
R601	7030008410	S.RES ERJ2GEJ 392 X (3.9K)	B	72.7/24.9
R602	7030008410	S.RES ERJ2GEJ 392 X (3.9K)	B	74.5/24.9
R603	7030008410	S.RES ERJ2GEJ 392 X (3.9K)	B	75.4/24.9
R604	7030008410	S.RES ERJ2GEJ 392 X (3.9K)	B	77.2/24.9
R605	7030008410	S.RES ERJ2GEJ 392 X (3.9K)	B	75.4/30.2
R606	7030008410	S.RES ERJ2GEJ 392 X (3.9K)	B	76.3/24.9
R608	7030010040	S.RES ERJ2GEJ-JPW	B	48.8/36.8
R609	7030005040	S.RES ERJ2GEJ 472 X (4.7K)	B	48.5/44.4
R610	7030010040	S.RES ERJ2GEJ-JPW	B	48.8/41.7
R612	7030005040	S.RES ERJ2GEJ 472 X (4.7K)	B	48.8/42.6
R613	7030003470	S.RES ERJ3GEYJ 182 V (1.8K)	B	52.6/46.1
R614	7030003470	S.RES ERJ3GEYJ 182 V (1.8K)	B	50.0/46.3
R651	7030005050	S.RES ERJ2GEJ 103 X (10K)	B	5.5/19.7
R652	7030005220	S.RES ERJ2GEJ 223 X (22K)	B	0.8/25.7
R653	7030005060	S.RES ERJ2GEJ 333 X (33K)	B	5.5/21.5
R654	7030005070	S.RES ERJ2GEJ 683 X (68K)	B	8.1/23.9
R655	7030005090	S.RES ERJ2GEJ 104 X (100K)	B	4.1/30.7
R656	7030005110	S.RES ERJ2GEJ 224 X (220K)	B	0.8/27.4
R657	7030005060	S.RES ERJ2GEJ 333 X (33K)	B	1.8/30.3
R658	7030005090	S.RES ERJ2GEJ 104 X (100K)	B	4.1/29.8
R659	7030003600	S.RES ERJ3GEYJ 223 V (22K)	B	8.4/28.5
R660	7030005720	S.RES ERJ2GEJ 563 X (56K)	B	13.3/30.0
R661	7030005220	S.RES ERJ2GEJ 223 X (22K)	B	13.7/27.2
R662	7030007350	S.RES ERJ2GEJ 393 X (39K)	B	13.7/28.8
R663	7030005220	S.RES ERJ2GEJ 223 X (22K)	B	13.2/20.6
R664	7030007340	S.RES ERJ2GEJ 153 X (15K)	B	5.7/29.8
R665	7030003600	S.RES ERJ3GEYJ 223 V (22K)	B	8.9/20.6
R666	7030004980	S.RES ERJ2GEJ 101 X (100)	B	13.1/25.3
R667	7030004980	S.RES ERJ2GEJ 101 X (100)	B	11.1/18.8
R668	7030004980	S.RES ERJ2GEJ 101 X (100)	B	9.8/24.2
R669	7030004980	S.RES ERJ2GEJ 101 X (100)	B	13.6/16.2
R701	7030004990	S.RES ERJ2GEJ 221 X (220)	T	18.5/48.0
R702	7030007280	S.RES ERJ2GEJ 331 X (330)	T	19.8/48.0
R703	7030007290	S.RES ERJ2GEJ 222 X (2.2K)	T	25.1/41.0
R704	7030005040	S.RES ERJ2GEJ 472 X (4.7K)	T	16.6/17.3
R705	7030007340	S.RES ERJ2GEJ 153 X (15K)	T	18.7/6.4
R721	7030004990	S.RES ERJ2GEJ 221 X (220)	T	20.2/6.3
R722	7030007280	S.RES ERJ2GEJ 331 X (330)	T	23.8/5.7
R723	7030003480	S.RES ERJ3GEYJ 222 V (2.2K)	T	47.5/2.4
R724	7030003520	S.RES ERJ3GEYJ 472 V (4.7K)	T	61.8/2.4
R725	7030003580	S.RES ERJ3GEYJ 153 V (15K)	T	75.9/2.4
R741	7030004990	S.RES ERJ2GEJ 221 X (220)	T	92.3/49.8
R742	7030007280	S.RES ERJ2GEJ 331 X (330)	T	95.8/49.7

Eqv.= This component is equivalent to the REF No. component listed above, and may be substituted on parts orders and repairs.

DISPLAY UNIT]

REF NO.	PARTS NO.	DESCRIPTION	M.	H/V LOCATION
R743	7030007290	S.RES ERJ2GEJ 222 X (2.2K)	T	102.1/35.0
R744	7030005040	S.RES ERJ2GEJ 472 X (4.7K)	T	102.1/25.5
R745	7030007340	S.RES ERJ2GEJ 153 X (15K)	T	100.6/8.6
R761	7030004990	S.RES ERJ2GEJ 221 X (220)	T	103.1/48.2
R762	7030007280	S.RES ERJ2GEJ 331 X (330)	T	104.9/47.9
R771	7030004990	S.RES ERJ2GEJ 221 X (220)	T	18.7/28.9
R772	7030007280	S.RES ERJ2GEJ 331 X (330)	T	18.1/29.9
R781	7030004990	S.RES ERJ2GEJ 221 X (220)	T	3.5/22.4
R782	7030007280	S.RES ERJ2GEJ 331 X (330)	T	3.5/24.2
R801	7030005240	S.RES ERJ2GEJ 473 X (47K)	B	62.1/21.8
R802	7030007270	S.RES ERJ2GEJ 151 X (150)	B	62.1/20.0
R803	7030005120	S.RES ERJ2GEJ 102 X (1K)	B	62.1/23.6
R2002	7030005240	S.RES ERJ2GEJ 473 X (47K)	T	110.4/40.7
R2003	7030005050	S.RES ERJ2GEJ 103 X (10K)	T	24.6/24.2
R2004	7030005050	S.RES ERJ2GEJ 103 X (10K)	T	24.6/26.3
R2005	7030005050	S.RES ERJ2GEJ 103 X (10K)	T	24.6/23.3
R2006	7030005050	S.RES ERJ2GEJ 103 X (10K)	T	24.6/25.3
R2007	7030007290	S.RES ERJ2GEJ 222 X (2.2K)	B	107.6/24.5
R2008	7030005220	S.RES ERJ2GEJ 223 X (22K)	T	78.3/18.4
R2009	7030005240	S.RES ERJ2GEJ 473 X (47K)	T	107.9/33.1
R2010	7030005090	S.RES ERJ2GEJ 104 X (100K)	B	79.7/16.9
R2011	7030005160	S.RES ERJ2GEJ 105 X (1M)	B	103.3/26.9
R2012	7030008010	S.RES ERJ2GEJ 123 X (12K)	B	103.3/37.3
R2013	7030005240	S.RES ERJ2GEJ 473 X (47K)	B	96.7/23.9
R2014	7030005290	S.RES ERJ2GEJ 682 X (6.8K)	T	24.1/41.0
R2015	7030005050	S.RES ERJ2GEJ 103 X (10K)	B	106.0/44.6
R2016	7030005240	S.RES ERJ2GEJ 473 X (47K)	B	92.2/37.9
R2017	7030005290	S.RES ERJ2GEJ 682 X (6.8K)	T	33.4/3.7
R2018	7030005240	S.RES ERJ2GEJ 473 X (47K)	T	102.2/41.8
R2019	7030005240	S.RES ERJ2GEJ 473 X (47K)	B	84.9/33.9
R2020	7030003450	S.RES ERJ3GEYJ 122 V (1.2K)	B	91.3/43.1
R2021	7030005240	S.RES ERJ2GEJ 473 X (47K)	B	97.1/40.8
R2022	7030005240	S.RES ERJ2GEJ 473 X (47K)	B	92.3/42.3
R2023	7030005240	S.RES ERJ2GEJ 473 X (47K)	B	100.1/42.8
R2024	7030005240	S.RES ERJ2GEJ 473 X (47K)	B	94.3/42.3
R2025	7030005240	S.RES ERJ2GEJ 473 X (47K)	B	93.3/42.3
R2026	7030005240	S.RES ERJ2GEJ 473 X (47K)	B	72.4/16.8
R2027	7030005240	S.RES ERJ2GEJ 473 X (47K)	B	70.6/16.9
R2028	7030005240	S.RES ERJ2GEJ 473 X (47K)	B	98.9/42.8
R2029	7030005240	S.RES ERJ2GEJ 473 X (47K)	B	73.5/16.8
R2030	7030007270	S.RES ERJ2GEJ 151 X (150)	T	108.0/11.8
R2031	7030007280	S.RES ERJ2GEJ 331 X (330)	T	108.8/40.2
R2033	7030007270	S.RES ERJ2GEJ 151 X (150)	T	19.5/20.3
R2034	7030005120	S.RES ERJ2GEJ 102 X (1K)	B	32.2/28.3
R2035	7030005120	S.RES ERJ2GEJ 102 X (1K)	B	32.6/30.9
R2036	7030005240	S.RES ERJ2GEJ 473 X (47K)	B	94.9/37.9
R2037	7030005240	S.RES ERJ2GEJ 473 X (47K)	B	94.0/37.9
R2039	7030005240	S.RES ERJ2GEJ 473 X (47K)	T	107.6/23.6
R2040	7030007340	S.RES ERJ2GEJ 153 X (15K)	B	116.4/8.8
R2041	7030007340	S.RES ERJ2GEJ 153 X (15K)	B	116.3/7.7
R2042	7030005050	S.RES ERJ2GEJ 103 X (10K)	B	79.7/31.3
R2043	7030005090	S.RES ERJ2GEJ 104 X (100K)	B	82.0/30.4
C2	4030018960	S.CER C3216 JB 1C 106MT-N	B	62.2/7.0
C3	4030018960	S.CER C3216 JB 1C 106MT-N	B	77.0/9.8
C4	4030017420	S.CER C1005 CH 1H 470J-T	B	35.4/10.7
C6	4030018960	S.CER C3216 JB 1C 106MT-N	B	28.1/6.1
C8	4030018960	S.CER C3216 JB 1C 106MT-N	B	30.2/6.1
C9	4030018960	S.CER C3216 JB 1C 106MT-N	B	39.2/4.5
C51	4030017420	S.CER C1005 CH 1H 470J-T	B	49.8/8.4
C53	4030018960	S.CER C3216 JB 1C 106MT-N	B	51.6/4.4
C55	4030018960	S.CER C3216 JB 1C 106MT-N	B	56.3/11.1
C56	4030018960	S.CER C3216 JB 1C 106MT-N	B	61.9/3.6
C57	4030017420	S.CER C1608 JB 1A 105K-T	B	44.0/11.8
C101	4030018960	S.CER C3216 JB 1C 106MT-N	B	85.7/6.3
C102	4030018960	S.CER C3216 JB 1C 106MT-N	B	94.7/4.6
C103	4030016930	S.CER C1005 JB 1A 104K-T	B	91.1/12.2
C104	4030016930	S.CER C1005 JB 1A 104K-T	B	89.5/12.2
C151	4550007520	S.TAN F931A106MAABMA [EUR]	B	97.0/4.6
Eqv.	4550006250	S.TAN TEESVA 1A 106M8R [EUR]		
C151	4550006250	S.TAN TEESVA 1A 106M8R [FRA]	B	97.0/4.6
Eqv.	4550007520	S.TAN F931A106MAABMA [FRA]		
C151	4550006250	S.TAN TEESVA 1A 106M8R [ESP]	B	97.0/4.6
Eqv.	4550007520	S.TAN F931A106MAABMA [ESP]		
C151	4550007520	S.TAN F931A106MAABMA [USA]	B	97.0/4.6
Eqv.	4550006250	S.TAN TEESVA 1A 106M8R [USA]		
C151	4550006250	S.TAN TEESVA 1A 106M8R [ITR]	B	97.0/4.6
Eqv.	4550007520	S.TAN F931A106MAABMA [ITR]		
C151	4550007520	S.TAN F931A106MAABMA [UK]	B	97.0/4.6

[DISPLAY UNIT]

REF NO.	PARTS NO.	DESCRIPTION	M.	H/V LOCATION
C153	4030016930	S.CER C1005 JB 1A 104K-T	B	99.7/2.6
C154	4030016930	S.CER C1005 JB 1A 104K-T	B	99.6/9.3
C251	4030017730	S.CER C1005 JB 1H 471K-T	B	147.5/46.4
C252	4030017730	S.CER C1005 JB 1H 471K-T	B	146.5/48.3
C253	4030017730	S.CER C1005 JB 1H 471K-T	B	144.7/48.3
C254	4030017730	S.CER C1005 JB 1H 471K-T	B	144.4/46.4
C255	4030017490	S.CER C1608 JB 1A 105K-T	T	149.0/51.0
C256	4030017490	S.CER C1608 JB 1A 105K-T	B	134.2/45.8
C301	4030017780	S.CER C1005 JB 1H 472K-T	T	108.3/20.0
C302	4030017780	S.CER C1005 JB 1H 472K-T	T	108.2/28.8
C303	4030006880	S.CER C1608 JB 1H 472K-T	T	113.1/27.1
C304	4030017780	S.CER C1005 JB 1H 472K-T	B	113.3/33.9
C305	4030017780	S.CER C1005 JB 1H 472K-T	T	114.9/12.6
C306	4030017780	S.CER C1005 JB 1H 472K-T	B	113.8/4.4
C312	4030017780	S.CER C1005 JB 1H 472K-T	T	108.2/29.7
C315	4030017780	S.CER C1005 JB 1H 472K-T	B	25.2/20.0
C316	4030017780	S.CER C1005 JB 1H 472K-T	B	26.1/20.0
C317	4030017780	S.CER C1005 JB 1H 472K-T	B	27.0/20.0
C318	4030017780	S.CER C1005 JB 1H 472K-T	B	24.0/19.9
C319	4030017780	S.CER C1005 JB 1H 472K-T	B	27.2/32.5
C320	4030017780	S.CER C1005 JB 1H 472K-T	B	26.3/32.5
C321	4030017780	S.CER C1005 JB 1H 472K-T	B	25.6/31.2
C322	4030017780	S.CER C1005 JB 1H 472K-T	T	24.6/27.3
C501	4550008190	S.TAN F931C107MNC [EUR]	B	53.4/21.0
Eqv.	4550007140	S.TAN TEESVD 1C 107M12R [EUR]		
C501	4550007140	S.TAN TEESVD 1C 107M12R [FRA]	B	53.4/21.0
Eqv.	4550008190	S.TAN F931C107MNC [FRA]		
C501	4550007140	S.TAN TEESVD 1C 107M12R [ESP]	B	53.4/21.0
Eqv.	4550008190	S.TAN F931C107MNC [ESP]		
C501	4550008190	S.TAN F931C107MNC [USA]	B	53.4/21.0
Eqv.	4550007140	S.TAN TEESVD 1C 107M12R [USA]		
C501	4550007140	S.TAN TEESVD 1C 107M12R [ITR]	B	53.4/21.0
Eqv.	4550008190	S.TAN F931C107MNC [ITR]		
C501	4550008190	S.TAN F931C107MNC [UK]	B	53.4/21.0
Eqv.	4550007140	S.TAN TEESVD 1C 107M12R [UK]		
C501	4550007140	S.TAN TEESVD 1C 107M12R [KOR]	B	53.4/21.0
Eqv.	4550008190	S.TAN F931C107MNC [KOR]		
C501	4550007140	S.TAN TEESVD 1C 107M12R [AUS]	B	53.4/21.0
Eqv.	4550008190	S.TAN F931C107MNC [AUS]		
C501	4550008190	S.TAN F931C107MNC [CHN]	B	53.4/21.0
Eqv.	4550007140	S.TAN TEESVD 1C 107M12R [CHN]		
C502	4550008190	S.TAN F931C107MNC [EUR]	B	45.4/21.0
Eqv.	4550007140	S.TAN TEESVD 1C 107M12R [EUR]		
C502	4550007140	S.TAN TEESVD 1C 107M12R [FRA]	B	45.4/21.0
Eqv.	4550008190	S.TAN F931C107MNC [FRA]		
C502	4550007140	S.TAN TEESVD 1C 107M12R [ESP]	B	45.4/21.0
Eqv.	4550008190	S.TAN F931C107MNC [ESP]		
C502	4550008190	S.TAN F931C107MNC [USA]	B	45.4/21.0
Eqv.	4550007140	S.TAN TEESVD 1C 107M12R [USA]		
C502	4550007140	S.TAN TEESVD 1C 107M12R [ITR]	B	45.4/21.0
Eqv.	4550008190	S.TAN F931C107MNC [ITR]		
C502	4550008190	S.TAN F931C107MNC [UK]	B	45.4/21.0
Eqv.	4550007140	S.TAN TEESVD 1C 107M12R [UK]		
C502	4550007140	S.TAN TEESVD 1C 107M12R [KOR]	B	45.4/21.0
Eqv.	4550008190	S.TAN F931C107MNC [KOR]		
C502	4550007140	S.TAN TEESVD 1C 107M12R [AUS]	B	45.4/21.0
Eqv.	4550008190	S.TAN F931C107MNC [AUS]		
C502	4550008190	S.TAN F931C107MNC [CHN]	B	45.4/21.0
Eqv.	4550007140	S.TAN TEESVD 1C 107M12R [CHN]		
C513	4030016930	S.CER C1005 JB 1A 104K-T	B	64.3/47.4
C514	4030016930	S.CER C1005 JB 1A 104K-T	B	63.3/47.4
C515	4030017490	S.CER C1608 JB 1A 105K-T	B	61.5/44.9
C516	4030018910	S.CER C1608 JB 0J 475K-T	B	67.7/48.9
C517	4030017490	S.CER C1608 JB 1A 105K-T	B	75.6/47.9
C518	4030017650	S.CER C1005 CH 1H 270J-T [EUR]	B	73.4/47.4
	4030017650	S.CER C1005 CH 1H 270J-T [FRA]		
	4030017650	S.CER C1005 CH 1H 270J-T [ESP]		
	4030017670	S.CER C1005 CH 1H 390J-T [USA]		
	4030017650	S.CER C1005 CH 1H 270J-T [ITR]		
	4030017650	S.CER C1005 CH 1H 270J-T [UK]		
	4030017670	S.CER C1005 CH 1H 390J-T [KOR]		
	4030017650	S.CER C1005 CH 1H 270J-T [AUS]		
	4030017650	S.CER C1005 CH 1H 270J-T [CHN]		
C519	4030016930	S.CER C1005 JB 1A 104K-T	B	77.0/48.5
C520	4030016930	S.CER C1005 JB 1A 104K-T	B	74.4/47.4
C521	4030018960	S.CER C3216 JB 1C 106MT-N	B	65.7/20.6
C522	4030016930	S.CER C1005 JB 1A 104K-T	B	69.7/19.9
C523	4030018970	S.CER C3225 JB 1C 226MT-N	B	53.4/28.9
C524	4030017700	S.CER C1005 CH 1H 151J-T	B	59.0/42.7
C525	4030016930	S.CER C1005 JB 1A 104K-T	B	55.4/30.3
C526	4030018090	S.CER C1005 JB 1E 822K-T	B	59.2/35.8
C527	4030018100	S.CER C1005 JB 1H 681K-T	B	59.0/46.0
C528	4030017730	S.CER C1005 JB 1H 471K-T	B	59.0/45.1
C529	4030018970	S.CER C3225 JB 1C 226MT-N	B	58.4/40.0
C530	4030016930	S.CER C1005 JB 1A 104K-T	B	77.2/39.1
C531	4030018970	S.CER C3225 JB 1C 226MT-N	B	81.3/35.9
C532	4030016930	S.CER C1005 JB 1A 104K-T	B	77.2/36.6
C533	4030017490	S.CER C1608 JB 1A 105K-T	B	77.1/44.5
C534	4030016970	S.CER C1005 JB 1E 223K-T	B	77.5/42.5
C536	4610001850	S.TRI TZBX4R200AB10R00	B	81.0/39.7
C537	4030016930	S.CER C1005 JB 1A 104K-T	B	77.2/40.1
C538	4030016930	S.CER C1005 JB 1A 104K-T	B	77.2/37.6
C539	4030018910	S.CER C1608 JB 0J 475K-T	B	77.7/34.9
C540	4030018910	S.CER C1608 JB 0J 475K-T	B	58.5/37.0
C541	4030018970	S.CER C3225 JB 1C 226MT-N	B	59.2/28.9
C542	4030018910	S.CER C1608 JB 0J 475K-T	B	77.7/33.6
C543	4030018960	S.CER C3216 JB 1C 106MT-N	B	80.0/46.6
C544	4030018910	S.CER C1608 JB 0J 475K-T	B	77.7/32.3
C545	4030011600	S.CER C1608 JB 1E 104K-T	B	77.0/46.4
C549	4030018960	S.CER C3216 JB 1C 106MT-N	B	71.7/28.8
C550	4030018960	S.CER C3216 JB 1C 106MT-N	B	77.1/28.8
C551	4030018960	S.CER C3216 JB 1C 106MT-N	B	73.8/28.8
C559	4030017460	S.CER C1005 JB 1H 102K-T	B	29.4/43.9
C560	4030018960	S.CER C3216 JB 1C 106MT-N	B	17.0/33.2

Eqv.= This component is equivalent to the REF No. component listed above, and may be substituted on parts orders and repairs.

[DISPLAY UNIT]

REF NO.	PARTS NO.	DESCRIPTION	M.	H/V LOCATION
C561	4030017330	S.CER C1005 JF 1C 104Z-T	B	7.3/30.8
C562	4030017780	S.CER C1005 JB 1H 472K-T	B	6.1/30.9
C601	4030016930	S.CER C1005 JB 1A 104K-T	B	73.6/24.9
C602	4030016930	S.CER C1005 JB 1A 104K-T	B	48.8/43.5
C603	4030016930	S.CER C1005 JB 1A 104K-T	B	55.0/39.4
C604	4030018960	S.CER C3216 JB 1C 106MT-N	B	55.8/36.3
C605	4030016930	S.CER C1005 JB 1A 104K-T	B	50.9/48.0
C606	4030018960	S.CER C3216 JB 1C 106MT-N	B	49.1/47.5
C607	4030011600	S.CER C1608 JB 1E 104K-T	B	55.5/40.6
C608	4030018960	S.CER C3216 JB 1C 106MT-N	B	55.8/43.7
C609	4030011600	S.CER C1608 JB 1E 104K-T	B	50.6/31.7
C610	4030018960	S.CER C3216 JB 1C 106MT-N	B	52.3/33.5
C611	4550007220	S.TAN F931A476MCMBMA	B	73.5/22.1
C651	4030018960	S.CER C3216 JB 1C 106MT-N	B	16.9/17.6
C652	4030018960	S.CER C3216 JB 1C 106MT-N	B	6.7/17.1
C653	4030011600	S.CER C1608 JB 1E 104K-T	B	15.8/19.3
C654	4030017490	S.CER C1608 JB 1A 104K-T	B	3.5/20.4
C655	4030016790	S.CER C1005 JB 1E 103K-T	B	0.8/30.3
C656	4030019090	S.CER C2012 JB 1C 225M-T	B	7.8/25.6
C657	4030018520	S.CER C1608 JB 0J 225M-T	B	7.0/20.6
C658	4030017650	S.CER C1005 CH 1H 270J-T	B	5.5/20.6
C659	4030017780	S.CER C1005 JB 1H 472K-T	B	15.3/20.4
C701	4030018960	S.CER C3216 JB 1C 106MT-N	B	4.7/32.5
C702	4030018960	S.CER C3216 JB 1C 106MT-N	B	49.0/19.1
C801	4030016930	S.CER C1005 JB 1A 104K-T	B	63.0/19.8
C802	4030011600	S.CER C1608 JB 1E 104K-T	B	21.6/48.6
C851	4030017780	S.CER C1005 JB 1H 472K-T	B	32.1/23.9
C852	4030018960	S.CER C3216 JB 1C 106MT-N	B	40.3/15.9
C853	4030016930	S.CER C1005 JB 1A 104K-T	B	43.2/27.6
C2001	4030018520	S.CER C1608 JB 0J 225M-T	B	78.5/16.7
C2002	4030017780	S.CER C1005 JB 1H 472K-T	T	114.8/34.7
C2003	4030017630	S.CER C1005 CH 1H 120J-T	B	103.3/28.7
C2004	4030017630	S.CER C1005 CH 1H 120J-T	B	103.3/25.1
C2005	4030016790	S.CER C1005 JB 1E 103K-T	B	103.3/34.9
C2006	4030016930	S.CER C1005 JB 1A 104K-T	B	98.0/37.9
C2007	4030018960	S.CER C3216 JB 1C 106MT-N	B	105.8/47.7
C2008	4030017030	S.CER C1005 JB 1A 273K-T	B	109.7/44.6
C2009	4030016930	S.CER C1005 JB 1A 104K-T	B	99.0/37.9
C2010	4030016930	S.CER C1005 JB 1A 104K-T	B	100.0/37.9
C2011	4030016930	S.CER C1005 JB 1A 104K-T	B	78.7/29.9
C2012	4030017780	S.CER C1005 JB 1H 472K-T	B	95.8/37.9
C2013	4030017780	S.CER C1005 JB 1H 472K-T	B	93.1/37.9
C2014	4030016930	S.CER C1005 JB 1A 104K-T	T	110.4/41.7
C2015	4030016930	S.CER C1005 JB 1A 104K-T	B	103.1/35.8
C2016	4030016930	S.CER C1005 JB 1A 104K-T	B	82.8/28.5
J202	6510023801	S.CON S4B-ZR-SM4A-TF(LF)(SN)	B	115.9/39.4
J251	6510025771	S.CON 03-935H1-72BKA	B	154.2/45.8
J303	6510021431	S.CON S8B-ZR-SM4A-TF(LF)(SN)	B	115.9/20.9
J401	6510024840	S.CON 52746-1070	B	21.3/26.3
J601	6510024780	S.CON 52437-2472	B	45.1/42.1
J2001	6510024790	S.CON 52559-1072	B	96.9/47.6
DS805	5040003610	S.LED NSSW008C-P1	T	29.5/39.5
DS806	5040003610	S.LED NSSW008C-P1	T	29.5/31.5
DS807	5040003610	S.LED NSSW008C-P1	T	29.5/24.2
DS808	5040003610	S.LED NSSW008C-P1	T	29.5/16.2
DS2001	5040002930	S.LED SML-512MW T86	T	110.3/25.8
DS2002	5040002020	S.LED CL-170UR-CD-T	T	110.3/36.8
DS2004	5040002930	S.LED SML-512MW T86	T	11.5/20.6
S201	2230001160	S.SWI SPVP110100	T	157.4/34.3
S251	2220000330	S.SWI HSW0880-01-210	B	139.7/46.6
S701	2230001150	S.SWI LS9J2M-1FG-T	T	22.2/48.3
S702	2230001150	S.SWI LS9J2M-1FG-T	T	21.7/36.5
S703	2230001150	S.SWI LS9J2M-1FG-T	T	20.9/17.0
S704	2230001150	S.SWI LS9J2M-1FG-T	T	21.6/2.7
S721	2230001150	S.SWI LS9J2M-1FG-T	T	40.2/2.4
S722	2230001150	S.SWI LS9J2M-1FG-T	T	54.3/2.4
S723	2230001150	S.SWI LS9J2M-1FG-T	T	68.5/2.4
S724	2230001150	S.SWI LS9J2M-1FG-T	T	82.6/2.4
S741	2230001150	S.SWI LS9J2M-1FG-T	T	98.1/47.9
S742	2230001150	S.SWI LS9J2M-1FG-T	T	99.1/32.1
S743	2230001150	S.SWI LS9J2M-1FG-T	T	99.1/20.5
S744	2230001150	S.SWI LS9J2M-1FG-T	T	98.1/5.8
S761	2230001150	S.SWI LS9J2M-1FG-T	T	109.5/49.1
S762	2230001150	S.SWI LS9J2M-1FG-T	T	109.5/3.5
S763	2230001150	S.SWI LS9J2M-1FG-T	T	154.9/47.5
S764	2230001150	S.SWI LS9J2M-1FG-T	T	154.9/5.2
S781	22300			

[VR UNIT]

REF NO.	PARTS NO.	DESCRIPTION	M.	H/V LOCATION
R1	7210003230	VAR TP96D00A-17F-10KBX2-2427	T	1.3/32.6
R2	7030003860	S.RES ERJ3GE JPW V	T	2.3/30.0
R3	7030003860	S.RES ERJ3GE JPW V	T	
J1	6510024850	S.CON 54550-1094	T	3.4/22.3
S1	2250000170	ENC TP90D96AE20-17F (1352)		
EP4	6910012350	S.BEA MMZ1608Y 102BT	T	2.7/32.6
EP5	6910012350	S.BEA MMZ1608Y 102BT	T	3.7/30.0
EP6	6910012350	S.BEA MMZ1608Y 102BT	T	0.9/30.0
EP7	6910012350	S.BEA MMZ1608Y 102BT	T	0.9/14.5
EP8	6910012350	S.BEA MMZ1608Y 102BT	T	3.7/14.5
EP9	6910012350	S.BEA MMZ1608Y 102BT	T	2.7/11.8
EP10	6910012350	S.BEA MMZ1608Y 102BT	T	2.3/14.5
EP11	6910012350	S.BEA MMZ1608Y 102BT	T	1.3/11.8

[LOGIC UNIT]

REF NO.	PARTS NO.	DESCRIPTION	M.	H/V LOCATION
IC1	1130013281	S.IC TC58FVM6T5BTG65GCT (2427D-6) 1	T	28.0/30.2
IC2	1130011151	S.IC SN74AHC2G08HDCT3	B	40.3/38.3
IC3	1130011151	S.IC SN74AHC2G08HDCT3	B	40.7/32.5
IC4	1130012600	S.IC SN74AHC1G04DCKR	B	43.6/33.8
IC51	1130012842	S.IC CY7C1021DV33-10BVXIT <FE>	B	24.5/28.6
IC301	1140012541	S.IC ADSP-BF532SBBCZ400 <FE>	B	28.6/39.2
IC401	1110004770	S.IC BU9480F-E2	T	77.5/27.9
IC451	1110006570	S.IC TS462CPT	T	34.1/50.2
IC502	1110006570	S.IC TS462CPT	T	30.7/5.4
IC551	1190001611	S.IC AK4528VFP-E2/P	T	17.9/8.1
IC601	1110006570	S.IC TS462CPT	B	12.7/10.8
IC701	1130012600	S.IC SN74AHC1G04DCKR	B	2.7/15.9
IC1201	1130012792	S.IC CY22150KFZXCX <FE>	B	44.6/4.6
IC1212	1140012170	S.IC BH7236AF-E2	T	57.7/7.3
IC1217	1130007181	S.IC TC7WU04FU(TE12LF)	B	63.5/9.9
IC1218	1130012761	S.IC SN74AHC2G86HDCT3	B	52.7/6.6
IC1226	1130010871	S.IC S1D13706F00A200	B	53.8/19.9
IC1251	1180002020	S.REG BA033FP-E2	T	79.5/5.2
IC1301	1130016310	S.IC BR24T256FJ-WE2	T	81.4/36.2
IC1302	1140013137	S.IC HD6432375A23FQV(SX-2427B-7)	T	54.9/25.2
IC1303	1110005771	S.IC S-80942CNMC-G9CT2G	T	81.2/10.4
IC1304	1130011551	S.IC RX-4581NB-F	B	71.9/7.3
IC1402	1130012781	S.IC SN74AHC2G04HDCT3	T	79.1/18.9
IC2002	1130012842	S.IC CY7C1021DV33-10BVXIT <FE>	B	32.7/28.4
IC2101	1130012850	S.IC SN74LVC3G34DCUR	T	44.5/44.8
IC2102	1130012850	S.IC SN74LVC3G34DCUR	T	44.5/41.3
IC2201	1140012541	S.IC ADSP-BF532SBBCZ400 <FE>	B	28.6/17.7
Q201	1550000110	S.FET RTQ035P02TR	B	18.9/42.7
Q1101	1530004140	S.TRA L2SC4081RT1G <SLVJ>	T	82.2/20.4
Q1102	1590003940	S.TRA RN1105(TE85LF)	T	81.9/22.8
Q1103	1510000510	S.TRA 2SA1576A T106R	T	81.9/16.4
Q1201	1590003940	S.TRA RN1105(TE85LF)	T	44.8/13.3
D201	1750001280	S.DIO CUS02(TE85LQ)	B	19.2/45.3
D1001	1750000370	S.DIO DA221 TL	B	64.6/36.9
D1002	1750000370	S.DIO DA221 TL	B	65.0/34.6
D1101	1790001251	S.DIO MA2S1110GL	T	82.0/18.4
D1106	1750000951	S.DIO MA2J7320GL	T	80.1/29.7
D1107	1790001670	S.DIO RB706F-40T106	T	82.4/31.4
D1110	1790001670	S.DIO RB706F-40T106	T	75.8/32.4
D1111	1790001670	S.DIO RB706F-40T106	T	75.3/29.4
D1112	1790001670	S.DIO RB706F-40T106	B	79.2/29.2
D1113	1790001670	S.DIO RB706F-40T106	B	82.4/30.7
D1201	1790001251	S.DIO MA2S1110GL	B	83.0/40.5
D1301	1790000661	S.DIO MA2J7280GL	B	77.6/2.9
D1304	1750000370	S.DIO DA221 TL	T	76.1/19.9
D1305	1750000370	S.DIO DA221 TL	T	75.9/16.8
D1306	1750000370	S.DIO DA221 TL	B	49.3/32.9
D1307	1750000370	S.DIO DA221 TL	B	51.4/33.3
D1311	1790001251	S.DIO MA2S1110GL	B	81.0/19.7
D1312	1790001251	S.DIO MA2S1110GL	B	83.1/18.6
D1313	1790001251	S.DIO MA2S1110GL	B	80.1/22.7
D1314	1790001241	S.DIO MA2S7280GL	B	81.7/22.5
D1331	1790001251	S.DIO MA2S1110GL	B	65.6/17.5
X1201	6050012150	S.XTA CR-806 SMD-49TA 4.433619 MHz<KDS> [EUR]	B	61.4/3.1
	6050012150	S.XTA CR-806 SMD-49TA 4.433619 MHz<KDS> [FRA]		
	6050012150	S.XTA CR-806 SMD-49TA 4.433619 MHz<KDS> [ESP]		
	6050012140	S.XTA CR-805 SMD-49TA 3.579545 MHz<KDS> [USA]		
	6050012150	S.XTA CR-806 SMD-49TA 4.433619 MHz<KDS> [ITR]		
	6050012150	S.XTA CR-806 SMD-49TA 4.433619 MHz<KDS> [UK]		
	6050012140	S.XTA CR-805 SMD-49TA 3.579545 MHz<KDS> [KOR]		
	6050012150	S.XTA CR-806 SMD-49TA 4.433619 MHz<KDS> [AUS]		
	6050012150	S.XTA CR-806 SMD-49TA 4.433619 MHz<KDS> [CHN]		
X1301	6050012190	S.XTA CR-809 SMD-49TA 1539744 MHz <KDS>	B	60.5/30.8
L201	6200011900	S.COI LQH43CN100K03L	T	16.0/42.0
L202	6200009491	S.COI CDRH6D28NP-100NCI	B	13.3/42.3
L551	6200005011	S.COI NLV25T-100J	T	11.2/10.5
L552	6200005011	S.COI NLV25T-100J	T	11.2/5.9
L1202	6200002041	S.COI NLV25T-101J	B	52.4/2.3
L1203	6200002041	S.COI NLV25T-101J	T	66.7/3.5
L1204	6200002041	S.COI NLV25T-101J	B	58.0/10.4
L2101	6200005011	S.COI NLV25T-100J	T	41.0/45.1
L2102	6200005011	S.COI NLV25T-100J	T	40.3/41.6
R2	7030005090	S.RES ERJ2GEJ 104 X (100K)	T	39.6/30.2
R3	7030005090	S.RES ERJ2GEJ 104 X (100K)	T	39.6/32.3
R4	7030005090	S.RES ERJ2GEJ 104 X (100K)	T	31.8/45.9
R5	7030005090	S.RES ERJ2GEJ 104 X (100K)	T	30.9/45.9
R6	7030005090	S.RES ERJ2GEJ 104 X (100K)	T	30.0/45.9
R203	7030000010	S.RES MCR10EZJH JPW (000)	T	20.8/45.7
R301	7030004980	S.RES ERJ2GEJ 101 X (100)	T	25.4/45.9
R302	7030005050	S.RES ERJ2GEJ 103 X (10K)	T	26.9/45.9
R303	7030005050	S.RES ERJ2GEJ 103 X (10K)	T	27.8/45.9
R306	7030005050	S.RES ERJ2GEJ 103 X (10K)	B	38.2/31.2
R307	7030005050	S.RES ERJ2GEJ 103 X (10K)	T	22.1/41.4
R308	7030005050	S.RES ERJ2GEJ 103 X (10K)	T	22.1/40.5

Eqv.= This component is equivalent to the REF No. component listed above, and may be substituted on parts orders and repairs.

M.=Mounted side (T: Mounted on the Top side, B: Mounted on the Bottom side) S.=Surface mount

[LOGIC UNIT]

REF NO.	PARTS NO.	DESCRIPTION	M.	H/V LOCATION
R310	7030005050	S.RES ERJ2GGEJ 103 X (10K)	B	35.4/38.0
R312	7030010040	S.RES ERJ2GGEJ-JPW	B	33.7/46.0
R313	7030010040	S.RES ERJ2GGEJ-JPW	B	35.6/43.3
R314	7030010040	S.RES ERJ2GGEJ-JPW	B	35.6/40.6
R413	7030004980	S.RES ERJ2GGEJ 101 X (100)	B	18.2/16.8
R414	7030004980	S.RES ERJ2GGEJ 101 X (100)	T	16.3/19.9
R415	7030004980	S.RES ERJ2GGEJ 101 X (100)	B	19.1/16.8
R416	7030004980	S.RES ERJ2GGEJ 101 X (100)	B	17.3/16.8
R462	7030004980	S.RES ERJ2GGEJ 101 X (100)	B	33.8/7.4
R463	7030004980	S.RES ERJ2GGEJ 101 X (100)	T	43.6/8.8
R464	7030004980	S.RES ERJ2GGEJ 101 X (100)	B	26.2/5.7
R465	7030009270	S.RES ERJ2GGEJ 821 X (820)	B	28.7/5.2
R467	7030004980	S.RES ERJ2GGEJ 101 X (100)	B	31.4/4.3
R469	7030009270	S.RES ERJ2GGEJ 821 X (820)	B	30.5/4.3
R470	7030009140	S.RES ERJ2GGEJ 272 X (2.7K)	T	29.4/3.1
R471	7030009140	S.RES ERJ2GGEJ 272 X (2.7K)	T	34.0/3.3
R472	7030005040	S.RES ERJ2GGEJ 472 X (4.7K)	T	38.7/4.2
R473	7030005040	S.RES ERJ2GGEJ 472 X (4.7K)	T	38.7/3.2
R474	7030009140	S.RES ERJ2GGEJ 272 X (2.7K)	B	24.8/7.2
R475	7030009140	S.RES ERJ2GGEJ 272 X (2.7K)	B	33.8/9.2
R476	7030005040	S.RES ERJ2GGEJ 472 X (4.7K)	T	40.3/3.3
R507	7030004980	S.RES ERJ2GGEJ 101 X (100)	T	26.1/3.6
R508	7030004980	S.RES ERJ2GGEJ 101 X (100)	T	31.7/9.0
R510	7030005040	S.RES ERJ2GGEJ 472 X (4.7K)	T	32.6/9.0
R511	7030005040	S.RES ERJ2GGEJ 472 X (4.7K)	T	29.0/9.0
R512	7030004980	S.RES ERJ2GGEJ 101 X (100)	T	29.9/9.0
R514	7030005050	S.RES ERJ2GGEJ 103 X (10K)	T	34.9/8.8
R515	7030005050	S.RES ERJ2GGEJ 103 X (10K)	T	34.9/7.9
R516	7030005040	S.RES ERJ2GGEJ 472 X (4.7K)	T	39.1/12.8
R517	7030005040	S.RES ERJ2GGEJ 472 X (4.7K)	T	36.5/11.1
R518	7030009140	S.RES ERJ2GGEJ 272 X (2.7K)	T	36.5/5.7
R519	7030009140	S.RES ERJ2GGEJ 272 X (2.7K)	T	26.5/5.7
R520	7030005040	S.RES ERJ2GGEJ 472 X (4.7K)	T	41.4/12.8
R551	7030004980	S.RES ERJ2GGEJ 101 X (100)	T	16.6/13.5
R553	7030004980	S.RES ERJ2GGEJ 101 X (100)	T	14.8/13.5
R554	7030005090	S.RES ERJ2GGEJ 104 X (100K)	T	15.5/3.3
R568	7030004980	S.RES ERJ2GGEJ 101 X (100)	T	13.0/13.5
R569	7030004980	S.RES ERJ2GGEJ 101 X (100)	T	15.7/13.5
R570	7030004980	S.RES ERJ2GGEJ 101 X (100)	T	13.9/13.5
R571	7030009320	S.RES ERJ2GGEJ 4R7 X (4.7)	B	20.7/8.4
R601	7030004980	S.RES ERJ2GGEJ 101 X (100)	T	3.1/12.4
R602	7030007300	S.RES ERJ2GGEJ 332 X (3.3K)	T	11.9/8.5
R603	7030005040	S.RES ERJ2GGEJ 472 X (4.7K)	B	12.4/4.9
R604	7030005040	S.RES ERJ2GGEJ 472 X (4.7K)	B	13.3/4.9
R605	7030007300	S.RES ERJ2GGEJ 332 X (3.3K)	B	14.5/5.2
R606	7030007300	S.RES ERJ2GGEJ 332 X (3.3K)	B	12.9/7.3
R607	7030005290	S.RES ERJ2GGEJ 682 X (6.8K)	B	13.9/7.3
R608	7030005290	S.RES ERJ2GGEJ 682 X (6.8K)	B	14.9/6.5
R609	7030005040	S.RES ERJ2GGEJ 472 X (4.7K)	T	11.0/8.5
R610	7030005040	S.RES ERJ2GGEJ 472 X (4.7K)	B	9.0/4.3
R611	7030005040	S.RES ERJ2GGEJ 472 X (4.7K)	B	9.9/4.3
R612	7030007300	S.RES ERJ2GGEJ 332 X (3.3K)	B	11.5/5.7
R613	7030007300	S.RES ERJ2GGEJ 332 X (3.3K)	B	8.9/7.0
R614	7030005290	S.RES ERJ2GGEJ 682 X (6.8K)	B	9.8/7.0
R615	7030005290	S.RES ERJ2GGEJ 682 X (6.8K)	B	10.7/7.0
R618	7030005120	S.RES ERJ2GGEJ 102 X (1K)	B	14.5/4.3
R619	7030005120	S.RES ERJ2GGEJ 102 X (1K)	B	10.8/4.3
R701	7030005050	S.RES ERJ2GGEJ 103 X (10K)	B	4.6/22.8
R702	7030005050	S.RES ERJ2GGEJ 103 X (10K)	B	4.6/23.7
R703	7030005050	S.RES ERJ2GGEJ 103 X (10K)	B	4.5/25.9
R705	7030005120	S.RES ERJ2GGEJ 102 X (1K)	B	5.0/21.0
R706	7030005050	S.RES ERJ2GGEJ 103 X (10K)	B	4.5/17.2
R707	7030007250	S.RES ERJ2GGEJ 220 X (22)	B	4.5/15.5
R1001	7030005120	S.RES ERJ2GGEJ 102 X (1K)	B	70.9/37.0
R1002	7030005050	S.RES ERJ2GGEJ 103 X (10K)	B	66.0/32.4
R1003	7030005160	S.RES ERJ2GGEJ 105 X (1M)	B	70.4/35.8
R1004	7030005240	S.RES ERJ2GGEJ 473 X (47K)	B	66.2/18.6
R1006	7030005120	S.RES ERJ2GGEJ 102 X (1K)	B	52.0/34.9
R1007	7030005120	S.RES ERJ2GGEJ 102 X (1K)	B	53.2/32.0
R1008	7030005120	S.RES ERJ2GGEJ 102 X (1K)	B	75.1/20.5
R1010	7030005240	S.RES ERJ2GGEJ 473 X (47K)	B	76.8/19.9
R1012	7030005000	S.RES ERJ2GGEJ 471 X (470)	B	66.5/34.1
R1013	7030005000	S.RES ERJ2GGEJ 471 X (470)	B	66.5/36.5
R1015	7030005240	S.RES ERJ2GGEJ 473 X (47K)	B	50.4/34.9
R1016	7030005240	S.RES ERJ2GGEJ 473 X (47K)	B	51.1/31.8
R1018	7030007340	S.RES ERJ2GGEJ 153 X (15K)	B	63.4/34.5
R1019	7030007340	S.RES ERJ2GGEJ 153 X (15K)	B	63.0/36.1
R1101	7030008290	S.RES ERJ2GGEJ 183 X (18K)	T	80.1/15.5
R1102	7030008010	S.RES ERJ2GGEJ 123 X (12K)	T	80.0/22.0
R1103	7030005120	S.RES ERJ2GGEJ 102 X (1K)	T	80.0/22.9
R1104	7030005120	S.RES ERJ2GGEJ 102 X (1K)	T	74.6/20.7
R1105	7030005050	S.RES ERJ2GGEJ 103 X (10K)	T	79.7/14.3
R1106	7030005240	S.RES ERJ2GGEJ 473 X (47K)	T	83.4/14.4
R1107	7030005090	S.RES ERJ2GGEJ 104 X (100K)	T	79.2/15.5
R1108	7030005090	S.RES ERJ2GGEJ 104 X (100K)	T	78.3/14.9
R1109	7030005160	S.RES ERJ2GGEJ 105 X (1M)	T	78.4/22.0
R1110	7030005240	S.RES ERJ2GGEJ 473 X (47K)	T	76.8/21.5
R1111	7030005090	S.RES ERJ2GGEJ 104 X (100K)	T	77.4/14.9
R1113	7030007290	S.RES ERJ2GGEJ 222 X (2.2K)	T	83.2/29.4
R1114	7030007300	S.RES ERJ2GGEJ 332 X (3.3K)	T	82.3/29.4
R1115	7030005120	S.RES ERJ2GGEJ 102 X (1K)	T	76.8/26.3
R1116	7030005120	S.RES ERJ2GGEJ 102 X (1K)	T	77.0/28.2
R1117	7030005120	S.RES ERJ2GGEJ 102 X (1K)	B	82.8/22.3
R1118	7030007300	S.RES ERJ2GGEJ 332 X (3.3K)	B	83.1/23.9
R1119	7030007300	S.RES ERJ2GGEJ 332 X (3.3K)	B	83.9/22.3
R1120	7030005120	S.RES ERJ2GGEJ 102 X (1K)	B	84.2/23.9
R1123	7030005160	S.RES ERJ2GGEJ 105 X (1M)	B	66.9/24.5
R1124	7030005120	S.RES ERJ2GGEJ 102 X (1K)	B	82.0/20.0
R1126	7030005160	S.RES ERJ2GGEJ 105 X (1M)	B	66.9/23.6
R1127	7030010040	S.RES ERJ2GGEJ-JPW	T	73.7/18.5
R1128	7030005120	S.RES ERJ2GGEJ 102 X (1K)	B	83.3/20.2
R1129	7030007300	S.RES ERJ2GGEJ 332 X (3.3K)	B	82.0/28.4
R1131	7030005090	S.RES ERJ2GGEJ 104 X (100K)	B	78.6/26.2
R1132	7030005040	S.RES ERJ2GGEJ 472 X (4.7K)	B	81.4/24.5
R1201	7030005160	S.RES ERJ2GGEJ 105 X (1M)	B	62.8/7.7

Eqv.= This component is equivalent to the REF No. component listed above, and may be substituted on parts orders and repairs.

[LOGIC UNIT]

REF NO.	PARTS NO.	DESCRIPTION	M.	H/V LOCATION
R1202	7030005050	S.RES ERJ2GGEJ 103 X (10K)	B	49.2/7.5
R1203	7030005050	S.RES ERJ2GGEJ 103 X (10K)	B	49.2/8.4
R1204	7030005050	S.RES ERJ2GGEJ 103 X (10K)	B	49.7/9.6
R1205	7030010040	S.RES ERJ2GGEJ-JPW	B	49.2/3.2
R1206	7030007570	S.RES ERJ2GGEJ 122 X (1.2K)	B	46.1/9.6
R1207	7030007570	S.RES ERJ2GGEJ 122 X (1.2K)	B	44.0/9.6
R1208	7030007570	S.RES ERJ2GGEJ 122 X (1.2K)	B	43.5/11.4
R1209	7030009710	S.RES ERJ2GGEJ 203 X (20K)	B	48.8/9.6
R1210	7030007570	S.RES ERJ2GGEJ 122 X (1.2K)	B	47.9/9.6
R1211	7030005050	S.RES ERJ2GGEJ 103 X (10K)	B	48.9/11.4
R1212	7030005050	S.RES ERJ2GGEJ 103 X (10K)	B	48.0/11.4
R1213	7030005050	S.RES ERJ2GGEJ 103 X (10K)	B	47.1/11.4
R1214	7030009710	S.RES ERJ2GGEJ 203 X (20K)	B	46.2/11.4
R1215	7030007350	S.RES ERJ2GGEJ 393 X (39K)	B	45.3/11.4
R1216	7030005050	S.RES ERJ2GGEJ 103 X (10K)	B	44.7/12.6
R1217	7030005050	S.RES ERJ2GGEJ 103 X (10K)	B	44.7/13.5
R1218	7030005050	S.RES ERJ2GGEJ 103 X (10K)	B	44.7/14.4
R1219	7030005040	S.RES ERJ2GGEJ 472 X (4.7K)	B	74.4/41.2
R1220	7030009710	S.RES ERJ2GGEJ 203 X (20K)	B	44.7/15.3
R1221	7030005040	S.RES ERJ2GGEJ 472 X (4.7K)	B	83.0/41.6
R1222	7030005040	S.RES ERJ2GGEJ 472 X (4.7K)	B	74.4/40.3
R1223	7030005040	S.RES ERJ2GGEJ 472 X (4.7K)	B	74.4/39.4
R1224	7030005040	S.RES ERJ2GGEJ 472 X (4.7K)	B	83.0/39.3
R1225	7030005240	S.RES ERJ2GGEJ 473 X (47K)	B	83.1/35.7
R1226	7030005240	S.RES ERJ2GGEJ 473 X (47K)	B	74.4/37.6
R1227	7030005240	S.RES ERJ2GGEJ 473 X (47K)	B	73.8/38.5
R1228	7030005240	S.RES ERJ2GGEJ 473 X (47K)	B	82.2/35.7
R1229	7030007350	S.RES ERJ2GGEJ 393 X (39K)	B	43.5/15.4
R1230	7030004970	S.RES ERJ2GGEJ 107 X (47)	B	49.2/2.3
R1231	7030005050	S.RES ERJ2GGEJ 103 X (10K)	B	48.8/5.4
R1232	7030005220	S.RES ERJ2GGEJ 224 X (22K)	B	40.3/3.3
R1235	7030007270	S.RES ERJ2GGEJ 151 X (150)	T	66.2/5.9
R1236	7030007270	S.RES ERJ2GGEJ 151 X (150)	T	66.2/7.0
R1237	7030007290	S.RES ERJ2GGEJ 222 X (2.2K)	B	61.2/7.7
R1251	7030011250	S.RES ERJ1TY 390U (39)	T	70.3/6.4
R1301	7030005220	S.RES ERJ2GGEJ 224 X (22K)	T	78.2/37.9
R1302	7030005050	S.RES ERJ2GGEJ 103 X (10K)	T	78.2/36.1
R1303	7030005240	S.RES ERJ2GGEJ 473 X (47K)	B	66.1/21.3
R1304	7030005240	S.RES ERJ2GGEJ 473 X (47K)	B	66.1/20.4
R1305	7030009160	S.RES ERJ2GGEJ 181 X (180)	T	68.6/26.0
R1306	7030005060	S.RES ERJ2GGEJ 333 X (33K)	T	78.8/11.5
R1307	7030005040	S.RES ERJ2GGEJ 472 X (4.7K)	T	68.0/22.0
R1308	7030005110	S.RES ERJ2GGEJ 224 X (220K)	T	67.6/20.1
R1309	7030005110	S.RES ERJ2GGEJ 224 X (220K)	T	69.1/19.5
R1310	7030005110	S.RES ERJ2GGEJ 224 X (220K)	T	67.6/18.9
R1311	7030005110	S.RES ERJ2GGEJ 224 X (220K)	T	69.1/18.3
R1312	7030005110	S.RES ERJ2GGEJ 224 X (220K)	T	67.6/17.7
R1313	7030005110	S.RES ERJ2GGEJ 224 X (220K)	T	69.1/17.1
R1314	7030005110	S.RES ERJ2GGEJ 224 X (220K)	T	67.6/16.5
R1315	7030005110	S.RES ERJ2GGEJ 224 X (220K)	T	69.1/15.9
R1316	7030005110	S.RES ERJ2GGEJ 224 X (220K)	B	66.6/12.4
R1317	7030005110	S.RES ERJ2GGEJ 224 X (220K)	B	65.7/12.4
R1318	7030005110	S.RES ERJ2GGEJ 224 X (220K)	B	64.8/12.4
R1319	7030005110	S.RES ERJ2GGEJ 224 X (220K)	B	63.9/12.4
R1320	7030005110	S.RES ERJ2GGEJ 224 X (220K)	B	63.0/12.4
R1321	7030005110	S.RES ERJ2GGEJ 224 X (220K)	B	62.1/12.4
R1322	7030005110	S.RES ERJ2GGEJ 224 X (220K)	B	61.2/12.4
R1323	7030005110	S.RES ERJ2GGEJ 224 X (220K)	B	60.3/12.2
R1324	7030005050	S.RES ERJ2GGEJ 103 X (10K)	T	80.5/12.6
R1325	7030007350	S.RES ERJ2GGEJ 393 X (39K)	T	78.2/9.9
R1326	7030005010	S.RES ERJ2GGEJ 681 X (680)	B	79.0/2.1
R1327	7030005240	S.RES ERJ2GGEJ 473 X (47K)	B	66.1/19.5
R1328	7030005050	S.RES ERJ2GGEJ 103 X (10K)	B	75.9/6.4
R1329	7030005240	S.RES ERJ2GGEJ 473 X (47K)	B	75.9/5.0
R1331	7030010040	S.RES ERJ2GGEJ-JPW	B	75.9/3.2
R1332	7030005040	S.RES ERJ2GGEJ 472 X (4.7K)	B	75.9/4.1
R1333	7030005110	S.RES ERJ2GGEJ 224 X (220K)	T	67.5/27.0
R1334	7030005050	S.RES ERJ2GGEJ 103 X (10K)	T	78.4/12.7
R1335	7030010040	S.RES ERJ2GGEJ-JPW	B	78.5/5.2
R1337	7030005240	S.RES ERJ2GGEJ 473 X (47K)	T	41.0/15.6
R1338	7030005240	S.RES ERJ2GGEJ 473 X (47		

[LOGIC UNIT]

REF NO.	PARTS NO.	DESCRIPTION	M.	H/V LOCATION
C1	4030016930	S.CER C1005 JB 1A 104K-T	T	16.9/25.2
C2	4030016930	S.CER C1005 JB 1A 104K-T	B	38.2/36.1
C3	4030016930	S.CER C1005 JB 1A 104K-T	B	39.6/29.0
C4	4030016930	S.CER C1005 JB 1A 104K-T	B	42.4/35.9
C5	4550007310	S.TAN F930J227MNMBA	T	40.8/23.5
C51	4030016930	S.CER C1005 JB 1A 104K-T	B	19.3/27.5
C52	4030016930	S.CER C1005 JB 1A 104K-T	B	19.3/28.4
C53	4550007310	S.TAN F930J227MNMBA	B	11.4/30.3
C54	4550007310	S.TAN F930J227MNMBA	T	7.2/8.1
C201	4030016930	S.CER C1005 JB 1A 104K-T	B	19.1/40.3
C203	4030018960	S.CER C3216 JB 1C 106MT-N	T	18.8/45.5
C204	4030016930	S.CER C1005 JB 1A 104K-T	T	12.0/40.2
C205	4030016930	S.CER C1005 JB 1A 104K-T	T	12.0/41.8
C206	4030016930	S.CER C1005 JB 1A 104K-T	B	8.9/43.5
C207	4030019460	S.CER C1608 JB 0J 106M-T	T	9.9/45.0
C302	4030016930	S.CER C1005 JB 1A 104K-T	T	30.3/40.5
C303	4030016930	S.CER C1005 JB 1A 104K-T	T	30.5/37.9
C304	4030016930	S.CER C1005 JB 1A 104K-T	T	27.0/37.3
C305	4030016930	S.CER C1005 JB 1A 104K-T	T	34.1/45.9
C306	4030016930	S.CER C1005 JB 1A 104K-T	T	29.3/37.3
C307	4030016930	S.CER C1005 JB 1A 104K-T	B	38.3/35.1
C308	4030016930	S.CER C1005 JB 1A 104K-T	T	27.4/39.4
C309	4030016930	S.CER C1005 JB 1A 104K-T	T	30.7/39.2
C310	4030016930	S.CER C1005 JB 1A 104K-T	T	24.5/45.9
C311	4030016930	S.CER C1005 JB 1A 104K-T	T	22.0/42.3
C312	4030016930	S.CER C1005 JB 1A 104K-T	T	27.9/40.6
C313	4030016930	S.CER C1005 JB 1A 104K-T	T	22.0/39.6
C314	4030016930	S.CER C1005 JB 1A 104K-T	T	29.1/45.9
C315	4030016930	S.CER C1005 JB 1A 104K-T	T	27.4/38.5
C316	4030016930	S.CER C1005 JB 1A 104K-T	T	30.5/37.0
C317	4030016930	S.CER C1005 JB 1A 104K-T	T	27.0/40.6
C318	4030016930	S.CER C1005 JB 1A 104K-T	T	31.2/40.5
C319	4030016930	S.CER C1005 JB 1A 104K-T	T	29.4/40.5
C320	4030016930	S.CER C1005 JB 1A 104K-T	T	27.9/37.3
C413	4030018960	S.CER C3216 JB 1C 106MT-N	B	21.3/19.7
C414	4030016930	S.CER C1005 JB 1A 104K-T	B	16.4/16.8
C415	4030018960	S.CER C3216 JB 1C 106MT-N	B	15.6/26.4
C461	4030016930	S.CER C1005 JB 1A 104K-T	B	34.2/4.3
C462	4030018960	S.CER C3216 JB 1C 106MT-N	B	35.3/5.9
C463	4030018960	S.CER C3216 JB 1C 106MT-N	T	42.1/8.8
C464	4030016930	S.CER C1005 JB 1A 104K-T	T	43.6/10.4
C465	4030017740	S.CER C1005 JB 1H 821K-T	B	27.5/5.5
C466	4030017760	S.CER C1005 JB 1H 222K-T	B	29.6/4.3
C467	4030017740	S.CER C1005 JB 1H 821K-T	B	30.8/5.5
C468	4030018560	S.CER C2012 JB 1A 475K-T	T	31.9/2.7
C469	4030016930	S.CER C1005 JB 1A 104K-T	B	24.8/8.8
C470	4030016930	S.CER C1005 JB 1A 104K-T	B	36.8/8.3
C471	4030018560	S.CER C2012 JB 1A 475K-T	T	32.3/4.3
C472	4030018560	S.CER C2012 JB 1A 475K-T	T	36.2/2.5
C473	4030016930	S.CER C1005 JB 1A 104K-T	T	40.3/4.2
C509	4030018960	S.CER C3216 JB 1C 106MT-N	T	24.3/5.6
C510	4030016930	S.CER C1005 JB 1A 104K-T	T	26.1/4.5
C511	4030017760	S.CER C1005 JB 1H 222K-T	T	30.8/9.0
C512	4030017690	S.CER C1005 CH 1H 121J-T	T	32.1/7.8
C513	4030017690	S.CER C1005 CH 1H 121J-T	T	29.4/7.8
C514	4030016930	S.CER C1005 JB 1A 104K-T	T	36.5/6.6
C515	4030018860	S.CER C1005 JB 0J 105K-T	T	36.5/9.3
C516	4030018860	S.CER C1005 JB 0J 105K-T	T	36.5/8.4
C517	4030018860	S.CER C1005 JB 0J 105K-T	T	36.5/10.2
C518	4030016930	S.CER C1005 JB 1A 104K-T	T	26.2/6.9
C519	4030016930	S.CER C1005 JB 1A 104K-T	T	41.4/11.9
C522	4030017780	S.CER C1005 JB 1H 472K-T	B	39.0/9.9
C523	4030017780	S.CER C1005 JB 1H 472K-T	B	38.1/2.9
C524	4030017780	S.CER C1005 JB 1H 472K-T	T	3.9/2.7
C525	4030017780	S.CER C1005 JB 1H 472K-T	T	22.5/2.8
C526	4030017780	S.CER C1005 JB 1H 472K-T	T	43.0/3.9
C527	4030017780	S.CER C1005 JB 1H 472K-T	B	24.1/2.9
C551	4030018520	S.CER C1608 JB 0J 225M-T	T	20.1/13.9
C553	4030016930	S.CER C1005 JB 1A 104K-T	T	19.0/13.9
C563	4030018960	S.CER C3216 JB 1C 106MT-N	B	18.9/6.7
C564	4030016930	S.CER C1005 JB 1A 104K-T	T	18.1/13.9
C565	4030016930	S.CER C1005 JB 1A 104K-T	T	17.8/3.3
C566	4030016930	S.CER C1005 JB 1A 104K-T	T	19.4/3.3
C567	4030018960	S.CER C3216 JB 1C 106MT-N	B	21.3/12.3
C569	4030018960	S.CER C3216 JB 1C 106MT-N	B	19.2/12.3
C601	4030018960	S.CER C3216 JB 1C 106MT-N	B	3.7/12.0
C602	4030016930	S.CER C1005 JB 1A 104K-T	T	4.0/11.0
C603	4030018820	S.CER C1005 JB 1H 561K-T	B	13.5/6.1
C604	4510008640	S.ELE 6 CE 100 FE	B	4.8/6.7
C605	4030016930	S.CER C1005 JB 1A 104K-T	T	10.1/8.5
C606	4030018580	S.CER C1608 CH 1H 821J-T	B	9.7/5.6
C607	4030017440	S.CER C1005 CH 1H 221J-T	B	13.4/8.5
C608	4030017440	S.CER C1005 CH 1H 221J-T	B	14.9/8.1
C609	4030018860	S.CER C1005 JB 0J 105K-T	B	15.8/14.6
C610	4030010760	S.CER C1608 CH 1H 331J-T	B	9.7/8.3
C611	4030010760	S.CER C1608 CH 1H 331J-T	B	11.8/7.8
C612	4030018960	S.CER C3216 JB 1C 106MT-N	B	7.5/13.2
C613	4550006780	S.TAN TEESVB2 0J 476M8R	B	20.6/2.8
Eqv.	4550007200	S.TAN F930J476MBA	T	3.1/6.6
C614	4550006780	S.TAN TEESVB2 0J 476M8R	T	3.1/6.6
Eqv.	4550007200	S.TAN F930J476MBA	T	3.1/6.6
C651	4030017460	S.CER C1005 JB 1H 102K-T	B	65.5/31.5
C652	4030017460	S.CER C1005 JB 1H 102K-T	B	66.0/16.5
C653	4030017460	S.CER C1005 JB 1H 102K-T	B	77.1/21.0
C654	4030017430	S.CER C1005 CH 1H 101J-T	B	77.2/28.2
C655	4030017430	S.CER C1005 CH 1H 101J-T	B	76.6/27.1
C656	4030017430	S.CER C1005 CH 1H 101J-T	B	76.2/26.2
C701	4030016930	S.CER C1005 JB 1A 104K-T	B	3.1/13.6
C702	4030017780	S.CER C1005 JB 1H 472K-T	B	4.5/18.8
C703	4030017780	S.CER C1005 JB 1H 472K-T	B	7.5/26.1
C704	4030017780	S.CER C1005 JB 1H 472K-T	B	19.8/26.2
C705	4030017430	S.CER C1005 CH 1H 101J-T	B	4.6/21.9
C706	4030017430	S.CER C1005 CH 1H 101J-T	B	4.6/24.6
C707	4030017430	S.CER C1005 CH 1H 101J-T	B	4.0/27.2
C708	4030017430	S.CER C1005 CH 1H 101J-T	B	6.6/26.1

Eqv.= This component is equivalent to the REF No. component listed above, and may be substituted on parts orders and repairs.

[LOGIC UNIT]

REF NO.	PARTS NO.	DESCRIPTION	M.	H/V LOCATION
C709	4030017430	S.CER C1005 CH 1H 101J-T	T	2.6/20.2
C711	4550007310	S.TAN F930J227MNMBA	T	5.6/19.0
C715	4030017460	S.CER C1005 JB 1H 102K-T	T	2.3/17.7
C716	4030017460	S.CER C1005 JB 1H 102K-T	T	2.3/16.7
C717	4030017460	S.CER C1005 JB 1H 102K-T	T	2.3/16.7
C1001	4030017780	S.CER C1005 JB 1H 472K-T	B	76.8/19.0
C1002	4030017780	S.CER C1005 JB 1H 472K-T	B	70.4/38.2
C1101	4030017780	S.CER C1005 JB 1H 472K-T	T	80.0/23.8
C1102	4030017780	S.CER C1005 JB 1H 472K-T	T	73.7/20.7
C1103	4030016930	S.CER C1005 JB 1A 104K-T	T	81.9/14.6
C1106	4030017780	S.CER C1005 JB 1H 472K-T	T	79.8/31.9
C1107	4030016930	S.CER C1005 JB 1A 473K-T	B	80.2/25.6
C1108	4030018900	S.CER C1005 JB 0J 474K-T	B	81.4/25.4
C1109	4030017780	S.CER C1005 JB 1H 472K-T	T	79.7/26.3
C1110	4030017780	S.CER C1005 JB 1H 472K-T	T	80.7/26.3
C1111	4030017780	S.CER C1005 JB 1H 472K-T	T	81.7/26.3
C1112	4030017780	S.CER C1005 JB 1H 472K-T	B	83.0/28.4
C1201	4030016930	S.CER C1005 JB 1A 104K-T	B	50.6/4.4
C1202	4030017780	S.CER C1005 JB 1H 472K-T	B	53.2/4.4
C1203	4030017650	S.CER C1005 CH 1H 270J-T	B	62.8/6.8
C1204	4030016930	S.CER C1005 JB 1A 104K-T	B	47.9/8.0
C1205	4030016930	S.CER C1005 JB 1A 104K-T	B	45.2/9.6
C1206	4030016930	S.CER C1005 JB 1A 104K-T	B	43.5/13.8
C1207	4030017430	S.CER C1005 CH 1H 101J-T	B	47.0/9.6
C1208	4030017430	S.CER C1005 CH 1H 101J-T	B	44.0/8.7
C1209	4030017430	S.CER C1005 CH 1H 101J-T	B	44.4/11.4
C1210	4030017650	S.CER C1005 CH 1H 270J-T	B	61.2/6.8
C1211	4030018860	S.CER C1005 JB 0J 105K-T	B	60.3/10.6
C1212	4030016930	S.CER C1005 JB 1A 104K-T	B	49.7/4.4
C1213	4030016930	S.CER C1005 JB 1A 104K-T	B	49.2/6.6
C1214	4030016930	S.CER C1005 JB 1A 104K-T	B	40.3/4.9
C1215	4030016930	S.CER C1005 JB 1A 104K-T	B	64.3/19.4
C1216	4030016930	S.CER C1005 JB 1A 104K-T	B	53.8/30.3
C1217	4030016930	S.CER C1005 JB 1A 104K-T	B	57.5/29.3
C1218	4030016930	S.CER C1005 JB 1A 104K-T	B	44.9/24.0
C1219	4030016930	S.CER C1005 JB 1A 104K-T	B	46.3/13.2
C1220	4030016930	S.CER C1005 JB 1A 104K-T	B	56.0/8.8
C1221	4030016930	S.CER C1005 JB 1A 104K-T	B	60.5/13.8
C1222	4030016930	S.CER C1005 JB 1A 104K-T	B	60.9/25.6
C1223	4030016930	S.CER C1005 JB 1A 104K-T	T	52.8/12.3
C1225	4030018960	S.CER C3216 JB 1C 106MT-N	T	66.8/10.2
C1251	4030012610	S.CER C2012 JB 1C 474K-T	T	73.5/9.4
C1252	4550007320	S.TAN F930J226MAABMA	T	73.5/4.5
C1301	4030016930	S.CER C1005 JB 1A 104K-T	T	80.2/40.3
C1302	4030018960	S.CER C3216 JB 1C 106MT-N	T	47.9/11.4
C1303	4030016790	S.CER C1005 JB 1E 103K-T	T	68.0/30.5
C1304	4030016930	S.CER C1005 JB 1A 104K-T	T	41.7/31.6
C1305	4030018960	S.CER C3216 JB 1C 106MT-N	T	44.3/37.3
C1306	4030016790	S.CER C1005 JB 1E 103K-T	T	64.1/37.6
C1307	4030016930	S.CER C1005 JB 1A 104K-T	T	48.5/13.0
C1308	4030016930	S.CER C1005 JB 1A 104K-T	T	63.2/13.2
C1309	4030016930	S.CER C1005 JB 1A 104K-T	T	46.2/37.3
C1310	4030016930	S.CER C1005 JB 1A 104K-T	T	67.1/31.0
C1311	4030016930	S.CER C1005 JB 1A 104K-T	T	67.1/25.8
C1312	4030017620	S.CER C1005 CH 1H 100C-T	T	67.5/29.2
C1313	4030017620	S.CER C1005 CH 1H 100C-T	T	67.5/28.3
C1314	4030016930	S.CER C1005 JB 1A 104K-T	T	79.1/9.9
C1315	4030017030	S.CER C1005 JB 1A 273K-T	T	83.4/10.9
C1316	4030016930	S.CER C1005 JB 1A 104K-T	B	75.9/2.3
C1317	4030018960	S.CER C3216 JB 1C 106MT-N	B	84.5/3.0
C1319	4030018960	S.CER C3216 JB 1C 106MT-N	B	16.8/6.7
C2016	4030016930	S.CER C1005 JB 1A 104K-T	B	37.7/29.4
C2017	4030016930	S.CER C1005 JB 1A 104K-T	B	37.7/30.3
C2101	4030016930	S.CER C1005 JB 1A 104K-T	T	44.1/43.0
C2102	4030016930	S.CER C1005 JB 1A 104K-T	T	45.8/43.0
C2202	4030016930	S.CER C1005 JB 1A 104K-T	T	27.1/16.6
C2204	4030016930	S.CER C1005 JB 1A 104K-T	T	26.6/19.3
C2205	4030016930	S.CER C1005 JB 1A 104K-T	T	30.2/19.8
C2206	4030016930	S.CER C1005 JB 1A 104K-T	T	26.6/11.1
C2207	4030016930	S.CER C1005 JB 1A 104K-T		

[CONNECT UNIT]

REF NO.	PARTS NO.	DESCRIPTION	M.	H/V LOCATION
J1	6510019971	S.CON 52808-1071	T	7.1/11.9
W1	8900016410	CAB OPC-1579A		

[DDS UNIT]

REF NO.	PARTS NO.	DESCRIPTION	M.	H/V LOCATION
IC51	1190001811	S.IC AD9833BRMZ-REEL7 <FE>	T	38.7/3.5
IC52	1130012781	S.IC SN74AHC2G04HDCT3	T	45.0/5.7
IC61	1130012610	S.IC SN74AHC1GU04DCKR	T	37.5/7.6
IC62	1130012850	S.IC SN74LVC3G34DCUR	T	51.4/24.7
IC251	1180002322	S.REG TK11218CMCL-GH	B	29.5/16.2
IC301	1190002101	S.IC AD9951YSVZ <FE>	T	37.5/28.2
IC401	1110004080	S.IC UPC2709T-E3	B	17.5/21.6
IC451	1110006430	S.IC UPC1678GV-E1-A	B	29.2/7.9
IC801	1110006430	S.IC UPC1678GV-E1-A	T	18.1/13.8
IC901	1130012720	S.IC CD74HC4094PWR	T	5.4/64.7
Q1	1530002381	S.TRA 2SC4215-Y(TE85LF)	T	20.5/3.2
Q101	1530002561	S.TRA 2SC4403-3-TL-E	T	26.6/6.4
Q151	1530003151	S.TRA 2SC4673D-TD-E	T	41.5/13.7
Q201	1530003432	S.TRA 2SC5226A-4-TL-E	T	43.5/19.5
Q211	1530003432	S.TRA 2SC5226A-4-TL-E	B	43.5/15.3
Q301	1590000680	S.TRA DTC114EUA T106	B	45.4/32.3
Q901	1590004030	S.TRA KRX204U-RTK/P	T	4.1/58.7
Q902	1590004030	S.TRA KRX204U-RTK/P	T	4.1/55.1
Q903	1590004030	S.TRA KRX204U-RTK/P	T	7.2/55.1
Q904	1590004030	S.TRA KRX204U-RTK/P	T	7.2/58.7
Q905	1590004030	S.TRA KRX204U-RTK/P	T	4.1/70.7
Q906	1590004030	S.TRA KRX204U-RTK/P	T	4.1/74.2
Q907	1590004030	S.TRA KRX204U-RTK/P	T	7.1/70.7
Q908	1590004030	S.TRA KRX204U-RTK/P	T	7.1/74.2
Q1101	1530004140	S.TRA L2SC4081RT1G <SLVJ>	T	40.9/53.9
Q1102	1540000451	S.TRA 2SD1623T-TD-E	T	45.5/54.3
D301	1750000620	S.DIO MA717WK(TX)	B	44.8/35.9
D341	1790001621	S.DIO 1SV308(TPL3F)	B	45.2/39.8
D451	1750000581	S.DIO 1SV307(TPH3F)	T	44.3/47.8
D452	1750000581	S.DIO 1SV307(TPH3F)	T	44.0/44.9
D453	1790001621	S.DIO 1SV308(TPL3F)	T	43.3/36.7
D454	1750000581	S.DIO 1SV307(TPH3F)	T	38.4/48.3
D456	1750000620	S.DIO MA717WK(TX)	B	35.2/42.9
D458	1750000581	S.DIO 1SV307(TPH3F)	T	33.8/45.6
D459	1750000581	S.DIO 1SV307(TPH3F)	T	31.4/38.9
D471	1750000620	S.DIO MA717WK(TX)	T	33.3/36.7
D501	1750000581	S.DIO 1SV307(TPH3F)	B	26.3/42.6
D502	1750000581	S.DIO 1SV307(TPH3F)	T	3.1/50.6
D551	1750000581	S.DIO 1SV307(TPH3F)	T	26.0/45.1
D552	1750000581	S.DIO 1SV307(TPH3F)	T	2.9/45.3
D601	1750000581	S.DIO 1SV307(TPH3F)	T	27.2/39.9
D602	1750000581	S.DIO 1SV307(TPH3F)	T	2.9/40.1
D651	1750000581	S.DIO 1SV307(TPH3F)	T	27.2/34.8
D652	1750000581	S.DIO 1SV307(TPH3F)	T	2.9/34.9
D701	1750000581	S.DIO 1SV307(TPH3F)	T	27.2/29.5
D702	1750000581	S.DIO 1SV307(TPH3F)	T	2.9/29.7
D751	1750000581	S.DIO 1SV307(TPH3F)	T	27.0/24.4
D752	1750000581	S.DIO 1SV307(TPH3F)	T	2.9/24.7
D801	1750000581	S.DIO 1SV307(TPH3F)	T	28.4/21.6
D802	1750000581	S.DIO 1SV307(TPH3F)	T	2.9/19.4
D1101	1750000301	S.DIO 1SS302(TE85RF)	T	40.9/57.7
D1102	1160000080	S.DIO DAP202K T146	B	28.0/63.1
FI101	2010002660	S.XTA DSF334SAF 124.032 MHz (FL-391)	T	29.4/10.7
FI201	2040001860	S.SAW NSVS776	T	34.5/16.6
X1	6050012800	S.XTA CR-788B VC-TCXO 24.8064 MHz	T	13.8/3.8
L51	6200005011	S.COI NLV25T-100J	B	35.6/4.2
L52	6200005011	S.COI NLV25T-100J	B	38.8/3.8
L53	6200003241	S.COI NLV32T-221J	B	43.5/8.7
L54	6200009351	S.COI ELJRE R22GFA	T	34.6/8.6
L101	6200003540	S.COI MLF1608D R22K-T	T	24.3/8.9
L105	6200012650	S.COI MLF1608A 1R5J-T	T	23.7/5.2
L151	6200004470	S.COI MLF1608D R12K-T	T	44.7/12.9
L153	6200004150	S.COI MLF1608D 47NM-T	T	46.9/15.7
L201	6200004150	S.COI MLF1608D 47NM-T	T	44.5/21.6
L202	6200005661	S.COI ELJRE 10NGFA	B	37.5/12.5
L204	6200003540	S.COI MLF1608D R22K-T	T	41.6/19.3
L205	6200005711	S.COI ELJRE 27NGFA	B	47.1/21.8
L206	6200005701	S.COI ELJRE 22NGFA	B	46.3/20.5
L210	6200005701	S.COI ELJRE 22NGFA	B	47.0/19.2
L212	6200002581	S.COI NLV25T-033J	B	41.9/12.8
L213	6200005681	S.COI ELJRE 15NGFA	B	40.1/17.9
L301	6140002810	S.COI LR-317	T	48.6/30.1
L302	6140002810	S.COI LR-317	T	48.8/38.9
L303	6200004150	S.COI MLF1608D 47NM-T	B	41.9/35.7
L304	6200003960	S.COI MLF1608A 1R0K-T	T	50.5/33.3
	6200003960	S.COI MLF1608A 1R0K-T	[EUR]	
	6200003960	S.COI MLF1608A 1R0K-T	[FRA]	
	6200003960	S.COI MLF1608A 1R0K-T	[ESP]	
	6200003960	S.COI MLF1608A 1R0K-T	[USA]	
	6200003960	S.COI MLF1608A 1R0K-T	[ITR]	
	6200003960	S.COI MLF1608A 1R0K-T	[UK]	
	6200003960	S.COI MLF1608A 1R0K-T	[KOR]	
	6200003960	S.COI MLF1608A 1R0K-T	[CHN]	
L321	6200009560	S.COI MLG1608B R10J-T	T	50.5/34.7
L322	6200011770	S.COI LQW18ANR10G00D	T	47.9/34.7
L323	6200005671	S.COI ELJRE 12NGFA	T	53.6/30.1
L331	6200009680	S.COI MLG1608B 47NJ-T	T	47.7/43.2
L332	6200009680	S.COI MLG1608B 47NJ-T	T	50.3/43.2
L341	6200004470	S.COI MLF1608D R12K-T	B	41.2/37.0
L401	6200001981	S.COI NLV25T-1R0J	T	50.3/50.0
L411	6200009610	S.COI MLG1608B 39NJ-T	T	47.3/48.4
L456	6140002810	S.COI LR-317	T	40.1/44.9
L458	6200009680	S.COI MLG1608B 47NJ-T	B	37.5/42.1
L461	6200009660	S.COI MLG1608B 10NJ-T	B	39.3/41.8
L464	6200002631	S.COI NLV25T-R10J	T	28.8/50.6

Eqv.= This component is equivalent to the REF No. component listed above, and may be substituted on parts orders and repairs.

M.=Mounted side (T: Mounted on the Top side, B: Mounted on the Bottom side) S.=Surface mount

[DDS UNIT]

REF NO.	PARTS NO.	DESCRIPTION	M.	H/V LOCATION
L465	6200004470	S.COI MLF1608D R12K-T	T	42.9/39.6
L466	6200011580	S.COI LQW18AN33NG00D	T	39.2/41.1
L467	6200009670	S.COI MLG1608B 12NJ-T	T	27.7/47.1
L468	6200009590	S.COI MLG1608B 18NJ-T	T	26.2/48.4
L469	6200009580	S.COI MLG1608B 15NJ-T	T	33.7/41.3
L471	6140002810	S.COI LR-317	T	38.7/37.3
L472	6200009680	S.COI MLG1608B 47NJ-T	T	33.4/39.4
L473	6200009540	S.COI MLG1608B 22NJ-T	T	35.5/40.5
L501	6200002611	S.COI NLV25T-R47J	B	21.8/43.7
L502	6200002631	S.COI NLV25T-R10J	B	18.2/46.8
L503	6200002431	S.COI NLV25T-082J	B	15.1/46.4
L504	6200002411	S.COI NLV25T-056J	T	14.4/49.4
L505	6200002421	S.COI NLV25T-068J	T	11.2/50.2
L506	6200002421	S.COI NLV25T-068J	T	8.3/49.7
L507	6200002611	S.COI NLV25T-R47J	T	3.9/48.2
L551	6200002611	S.COI NLV25T-R47J	T	24.9/42.6
L552	6200002421	S.COI NLV25T-068J	T	20.4/43.0
L553	6200002411	S.COI NLV25T-056J	T	17.6/42.9
L554	6200002601	S.COI NLV25T-047J	T	14.8/45.0
L555	6200002601	S.COI NLV25T-047J	T	12.0/44.3
L556	6200002581	S.COI NLV25T-033J	T	9.3/45.0
L557	6200002611	S.COI NLV25T-R47J	T	4.5/42.9
L601	6200002611	S.COI NLV25T-R47J	T	25.3/37.4
L602	6200002601	S.COI NLV25T-047J	T	22.6/39.6
L603	6200002591	S.COI NLV25T-039J	T	19.8/39.1
L604	6200003891	S.COI NLV25T-027J	T	16.9/39.9
L605	6200002601	S.COI NLV25T-047J	T	14.2/37.9
L606	6200002601	S.COI NLV25T-047J	T	11.4/37.7
L607	6200002421	S.COI NLV25T-068J	T	8.6/37.7
L608	6200002601	S.COI NLV25T-047J	T	5.1/37.7
L651	6200002611	S.COI NLV25T-R47J	T	26.0/32.2
L652	6200002591	S.COI NLV25T-039J	T	22.4/32.5
L653	6200002591	S.COI NLV25T-039J	T	19.6/32.8
L654	6200002591	S.COI NLV25T-039J	T	14.0/34.6
L655	6200002591	S.COI NLV25T-039J	T	11.2/33.9
L656	6200002601	S.COI NLV25T-047J	T	16.7/32.5
L657	6200002581	S.COI NLV25T-033J	T	7.9/34.6
L658	6200002611	S.COI NLV25T-R47J	T	5.2/32.6
L701	6200002611	S.COI NLV25T-R47J	T	26.0/26.9
L702	6200002581	S.COI NLV25T-033J	T	23.0/29.2
L703	6200002581	S.COI NLV25T-033J	T	20.2/28.8
L704	6200003891	S.COI NLV25T-027J	T	17.3/29.5
L705	6200002591	S.COI NLV25T-039J	T	14.6/27.3
L706	6200002581	S.COI NLV25T-033J	T	11.9/27.3
L707	6200002581	S.COI NLV25T-033J	T	9.1/27.3
L708	6200002611	S.COI NLV25T-R47J	T	4.6/27.3
L751	6200002611	S.COI NLV25T-R47J	T	26.0/22.0
L752	6200003881	S.COI NLV25T-022J	T	22.5/22.4
L753	6200003891	S.COI NLV25T-027J	T	19.7/22.2
L754	6200002581	S.COI NLV25T-033J	T	17.0/22.5
L755	6200003891	S.COI NLV25T-027J	T	14.2/24.2
L756	6200003891	S.COI NLV25T-027J	T	11.5/23.5
L757	6200003881	S.COI NLV25T-022J	T	8.7/24.2
L758	6200002611	S.COI NLV25T-R47J	T	4.0/22.3
L801	6200002181	S.COI NLV25T-R12J	T	28.4/17.6
L803	6200005711	S.COI ELJRE 27NGFA	T	26.3/17.6
L804	6200009070	S.COI LQW18AN18NG00D (LQW1608A18NG00)	T	25.1/15.6
L805	6200009220	S.COI LQW18AN15NG00D (LQW1608A15NG00)	T	23.2/15.0
L806	6200005641	S.COI ELJRE 6N8ZFA	T	21.6/19.0
L807	6200009670	S.COI MLG1608B 12NJ-T	T	18.7/18.3
L808	6200004720	S.COI MLF1608D R10K-T	T	18.0/10.1
L812	6200005711	S.COI ELJRE 27NGFA	T	14.9/14.5
L813	6200009070	S.COI LQW18AN18NG00D (LQW1608A18NG00)	T	15.8/17.3
L814	6200009220	S.COI LQW18AN15NG00D (LQW1608A15NG00)	T	13.9/18.3
L815	6200005641	S.COI ELJRE 6N8ZFA	T	10.1/18.1
L816	6200010700	S.COI LQW18AN12NG00D	T	6.6/17.9
L818	6200002181	S.COI NLV25T-R12J	T	4.6/17.0
L851	6200002181	S.COI NLV25T-R12J	B	26.8/30.6
L852	6200002611	S.COI NLV25T-R47J	B	26.4/34.1
L853	6200002181	S.COI NLV25T-R12J	B	3.4/22.8
L854	6200002611	S.COI NLV25T-R47J	B	5.4/26.0
L901	6200007420	S.COI ELJFC 101K-F	B	3.8/66.0
L953	6200002041	S.COI NLV25T-101J	B	56.5/44.6
L954	6200002041	S.COI NLV25T-101J	B	55.8/42.1
L955	6200002041	S.COI NLV25T-101J	B	55.9/39.6
L956	6200002041	S.COI NLV25T-101J	B	56.1/37.1
L957	6200002041	S.COI NLV25T-101J	B	56.0/34.6
L959	6200011300	S.COI EXCML16A270U	T	54.9/34.3
L960	6200002041	S.COI NLV25T-101J	B	56.7/30.3
L962	6200011300	S.COI EXCML16A270U	B	59.2/32.2
L963	6200011300	S.COI EXCML16A270U	B	60.4/32.2
L1001	6200003241	S.COI NLV32T-221J	B	53.7/50.9
L1002	6200003241	S.COI NLV32T-221J	B	47.9/55.0
L1103	6200002041	S.COI NLV25T-101J	B	42.2/61.2
L1105	6200002041	S.COI NLV25T-101J	B	40.8/71.8
L1106	6200002041	S.COI NLV25T-101J	T	36.4/62.3
L1107	6200002041	S.COI NLV25T-101J	B	34.9/74.7
L1110	6200002041	S.COI NLV25T-101J	T	32.4/62.3
L1111	6200002041	S.COI NLV25T-101J	B	26.1/69.8
L1112	6200002041	S.COI NLV25T-101J	T	29.9/62.3
L1152	6200003590	S.COI EXCCL3225U1	T	48.3/69.2
L1153	6200002041	S.COI NLV25T-101J	T	45.5/69.3
L1154	6200002041	S.COI NLV25T-101J	T	53.6/69.2
R2	7030007290	S.RES ERJ2GEJ 222 X (2.2K)	T	19.1/4.6
R3	7030005040	S.RES ERJ2GEJ 472 X (4.7K)	T	18.7/1.8
R4	7030004990	S.RES ERJ2GEJ 221 X (220)	T	22.2/2.6
R5	7030004980	S.RES ERJ2GEJ 101 X (100)	T	20.9/6.9
R8	7030003630	S.RES ERJ3GEYJ 393 V (39K)	B	13.7/7.2
R9	7030003610	S.RES ERJ3GEYJ 273 V (27K)	B	13.7/9.8

Eqv.= This component is equivalent to the REF No. component listed above, and may be substituted on parts orders and repairs.

[DDS UNIT]

REF NO.	PARTS NO.	DESCRIPTION	M.	H/V LOCATION
R10	7030005060	S.RES ERJ2GEJ 333 X (33K)	T	8.1/3.3
R11	7030010040	S.RES ERJ2GEJ-JPW	T	9.3/3.7
R51	7030005120	S.RES ERJ2GEJ 102 X (1K)	T	35.8/9.5
R52	7030005120	S.RES ERJ2GEJ 102 X (1K)	T	46.2/2.3
R53	7030005120	S.RES ERJ2GEJ 102 X (1K)	T	42.8/3.6
R54	7030005120	S.RES ERJ2GEJ 102 X (1K)	T	42.8/2.7
R61	7030005050	S.RES ERJ2GEJ 103 X (10K)	T	39.3/8.1
R62	7030005530	S.RES ERJ2GEJ 100 X (10)	T	49.3/23.2
R101	7030005000	S.RES ERJ2GEJ 471 X (470)	T	25.2/7.8
R102	7030004980	S.RES ERJ2GEJ 101 X (100)	T	22.1/7.4
R103	7030005570	S.RES ERJ2GEJ 820 X (82)	T	31.9/11.1
R104	7030004980	S.RES ERJ2GEJ 101 X (100)	T	33.1/11.6
R105	7030005570	S.RES ERJ2GEJ 820 X (82)	T	34.3/11.2
R106	7030005100	S.RES ERJ2GEJ 154 X (150K)	T	23.9/7.4
R121	7030005040	S.RES ERJ2GEJ 472 X (4.7K)	T	38.5/11.1
R150	7030005570	S.RES ERJ2GEJ 820 X (82)	T	45.9/10.7
R151	7030004980	S.RES ERJ2GEJ 101 X (100)	T	45.0/10.7
R154	7030005050	S.RES ERJ2GEJ 103 X (10K)	T	41.5/10.7
R155	7030005530	S.RES ERJ2GEJ 100 X (10)	T	46.3/11.2
R157	7030007270	S.RES ERJ2GEJ 151 X (150)	T	48.9/18.2
R158	7030009200	S.RES ERJ2GEJ 390 X (39)	T	48.0/16.8
R159	7030007270	S.RES ERJ2GEJ 151 X (150)	T	48.0/18.2
R160	7030005300	S.RES ERJ2GEJ 150 X (15)	T	44.2/16.0
R161	7030004980	S.RES ERJ2GEJ 101 X (100)	T	45.1/16.0
R162	7030005300	S.RES ERJ2GEJ 150 X (15)	T	45.0/14.7
R201	7030005530	S.RES ERJ2GEJ 100 X (10)	T	45.9/22.1
R202	7030000700	S.RES MCR10EZHJ 470 K (474)	T	45.7/18.8
R211	7030003400	S.RES ERJ3GEYJ 471 V (470)	B	37.3/17.9
R212	7030003440	S.RES ERJ3GEYJ 102 V (1K)	B	40.8/16.3
R213	7030003200	S.RES ERJ3GEYJ 100 V (10)	B	44.6/11.4
R214	7030003280	S.RES ERJ3GEYJ 470 V (47)	B	46.8/16.4
R301	7030005120	S.RES ERJ2GEJ 102 X (1K)	T	34.2/22.2
R303	7030010040	S.RES ERJ2GEJ-JPW	T	40.0/22.2
R304	7030005120	S.RES ERJ2GEJ 102 X (1K)	T	42.0/24.6
R305	7030005710	S.RES ERJ2GEJ 121 X (120)	T	44.2/29.0
R306	7030005120	S.RES ERJ2GEJ 102 X (1K)	T	31.6/25.7
R309	7030005120	S.RES ERJ2GEJ 102 X (1K)	T	31.2/29.5
R310	7030005120	S.RES ERJ2GEJ 102 X (1K)	T	31.3/30.5
R311	7030005120	S.RES ERJ2GEJ 102 X (1K)	T	31.3/31.5
R312	7030010040	S.RES ERJ2GEJ-JPW	T	32.9/31.7
R313	7030005710	S.RES ERJ2GEJ 121 X (120)	T	43.3/28.5
R314	7030009140	S.RES ERJ2GEJ 272 X (2.7K)	T	43.0/31.8
R315	7030005120	S.RES ERJ2GEJ 102 X (1K)	T	33.5/32.6
R316	7030005050	S.RES ERJ2GEJ 103 X (10K)	T	34.6/33.8
R317	7030004990	S.RES ERJ2GEJ 221 X (220)	T	43.9/31.8
R318	7030003860	S.RES ERJ3GE JPW V	B	35.8/28.4
R341	7030003440	S.RES ERJ3GEYJ 102 V (1K)	B	44.4/38.3
R342	7030003440	S.RES ERJ3GEYJ 102 V (1K)	B	46.0/41.2
R451	7030005120	S.RES ERJ2GEJ 102 X (1K)	T	44.6/46.3
R452	7030003860	S.RES ERJ3GE JPW V	B	48.6/44.6
R453	7030010090	S.RES ERJ2GEJ 180 X (18)	T	34.1/47.5
R454	7030008280	S.RES ERJ2GEJ 271 X (270)	T	32.9/47.1
R455	7030008280	S.RES ERJ2GEJ 271 X (270)	T	32.9/48.0
R456	7030010040	S.RES ERJ2GEJ-JPW	T	34.9/52.5
R457	7030005120	S.RES ERJ2GEJ 102 X (1K)	T	38.2/49.7
R458	7030004990	S.RES ERJ2GEJ 221 X (220)	T	31.6/43.6
R459	7030005090	S.RES ERJ2GEJ 104 X (100K)	T	42.1/50.0
R460	7030003680	S.RES ERJ3GEYJ 104 V (100K)	T	30.8/41.1
R461	7030005090	S.RES ERJ2GEJ 104 X (100K)	T	29.7/39.1
R462	7030003860	S.RES ERJ3GE JPW V	T	45.1/43.3
R463	7030003400	S.RES ERJ3GEYJ 471 V (470)	T	33.3/44.1
R464	7030004980	S.RES ERJ2GEJ 101 X (100)	T	40.8/49.8
R465	7030005570	S.RES ERJ2GEJ 820 X (82)	T	40.3/50.0
R467	7030005570	S.RES ERJ2GEJ 820 X (82)	T	40.8/48.8
R468	7030005570	S.RES ERJ2GEJ 820 X (82)	T	41.2/50.0
R469	7030003320	S.RES ERJ3GEYJ 101 V (100)	B	37.8/40.0
R471	7030005000	S.RES ERJ2GEJ 471 X (470)	T	41.7/37.7
R472	7030004990	S.RES ERJ2GEJ 221 X (220)	T	30.4/33.3
R473	7030007270	S.RES ERJ2GEJ 151 X (150)	T	31.8/34.5
R474	7030009200	S.RES ERJ2GEJ 390 X (39)	T	31.3/35.7
R475	7030007270	S.RES ERJ2GEJ 151 X (150)	T	30.1/35.4
R476	7030005000	S.RES ERJ2GEJ 471 X (470)	T	30.0/37.9
R477	7030003320	S.RES ERJ3GEYJ 101 V (100)	B	35.8/38.7
R501	7030003390	S.RES ERJ3GEYJ 391 V (390)	B	21.0/46.1
R502	7030009280	S.RES ERJ2GEJ 391 X	T	5.9/46.9
R503	7030005090	S.RES ERJ2GEJ 104 X (100K)	T	14.3/46.8
R505	7030005570	S.RES ERJ2GEJ 820 X (82)	T	6.5/48.6
R506	7030005570	S.RES ERJ2GEJ 820 X (82)	T	6.1/49.8
R507	7030005570	S.RES ERJ2GEJ 820 X (82)	T	5.6/48.6
R551	7030009280	S.RES ERJ2GEJ 391 X	T	23.1/42.0
R552	7030009280	S.RES ERJ2GEJ 391 X	T	6.3/42.0
R553	7030005090	S.RES ERJ2GEJ 104 X (100K)	T	10.1/41.6
R554	7030009200	S.RES ERJ2GEJ 390 X (39)	T	6.4/45.7
R555	7030007270	S.RES ERJ2GEJ 151 X (150)	T	7.2/44.5
R556	7030007270	S.RES ERJ2GEJ 151 X (150)	T	6.3

DDS UNIT]

REF NO.	PARTS NO.	DESCRIPTION	M.	H/V LOCATION
R805	7030005570	S.RES ERJ2GEJ 820 X (82)	T	14.0/10.4
R806	7030005570	S.RES ERJ2GEJ 820 X (82)	T	14.3/11.7
R807	7030005570	S.RES ERJ2GEJ 820 X (82)	T	13.1/11.3
R808	7030003390	S.RES ERJ3GEYJ 391 V (390)	B	3.6/17.9
R810	7030005090	S.RES ERJ2GEJ 104 X (100K)	T	27.3/15.5
R841	7030005710	S.RES ERJ2GEJ 121 X (120)	T	21.2/12.6
R851	7030009280	S.RES ERJ2GEJ 391 X	T	27.1/37.3
R852	7030008280	S.RES ERJ2GEJ 271 X (270)	T	5.7/13.8
R853	7030010090	S.RES ERJ2GEJ 180 X (18)	T	6.9/14.0
R854	7030008280	S.RES ERJ2GEJ 271 X (270)	T	6.9/13.0
R855	7030003390	S.RES ERJ3GEYJ 391 V (390)	B	5.5/29.5
R901	7030005120	S.RES ERJ2GEJ 102 X (1K)	T	2.1/62.6
R902	7030005120	S.RES ERJ2GEJ 102 X (1K)	T	2.2/60.9
R903	7030005120	S.RES ERJ2GEJ 102 X (1K)	T	2.3/58.7
R951	7030003360	S.RES ERJ3GEYJ 221 V (220)	B	59.2/6.9
R952	7030004990	S.RES ERJ2GEJ 221 X (220)	T	54.1/9.3
R953	7030003360	S.RES ERJ3GEYJ 221 V (220)	B	59.5/3.3
R954	7030004990	S.RES ERJ2GEJ 221 X (220)	T	53.2/8.9
R955	7030004990	S.RES ERJ2GEJ 221 X (220)	T	55.3/7.8
R956	7030003360	S.RES ERJ3GEYJ 221 V (220)	B	59.2/4.9
R957	7030003360	S.RES ERJ3GEYJ 221 V (220)	B	56.6/5.0
R958	7030004990	S.RES ERJ2GEJ 221 X (220)	T	47.3/6.2
R959	7030003360	S.RES ERJ3GEYJ 221 V (220)	B	57.9/51.0
R960	7030003280	S.RES ERJ3GEYJ 470 V (47)	B	57.6/49.0
R961	7030004990	S.RES ERJ2GEJ 221 X (220)	T	54.6/11.7
R962	7030003860	S.RES ERJ3GE JPW V	T	51.4/21.0
R1051	7030003860	S.RES ERJ3GE JPW V	B	10.8/73.0
R1101	7030005120	S.RES ERJ2GEJ 102 X (1K)	T	40.6/52.2
R1102	7030005050	S.RES ERJ2GEJ 103 X (10K)	T	42.2/52.2
R1103	7030004980	S.RES ERJ2GEJ 101 X (100)	T	39.3/63.4
R1104	7030005050	S.RES ERJ2GEJ 103 X (10K)	T	44.2/51.3
R1105	7030004980	S.RES ERJ2GEJ 101 X (100)	T	38.7/60.9
R1106	7030007290	S.RES ERJ2GEJ 222 X (2.2K)	T	31.8/59.6
R1107	7030007290	S.RES ERJ2GEJ 222 X (2.2K)	T	28.1/59.6
R1108	7030005240	S.RES ERJ2GEJ 473 X (47K)	T	46.9/8.5
R1109	7030005240	S.RES ERJ2GEJ 473 X (47K)	T	47.9/8.5
C1	4030016950	S.CER C1005 JB 1A 473K-T	T	17.5/4.6
C2	4030017780	S.CER C1005 JB 1H 472K-T	T	20.9/5.0
C3	4030017510	S.CER C1005 CH 1H 680J-T	T	24.9/17.7
C4	4030017780	S.CER C1005 JB 1H 472K-T	T	22.4/4.6
C5	4030017680	S.CER C1005 CH 1H 820J-T	T	26.1/2.0
C6	4030017510	S.CER C1005 CH 1H 680J-T	T	27.3/1.7
C7	4030016930	S.CER C1005 JB 1A 104K-T	T	8.1/4.2
C8	4030016790	S.CER C1005 JB 1E 103K-T	T	10.1/5.7
C51	4030017780	S.CER C1005 JB 1H 472K-T	T	33.8/6.5
C52	4030017780	S.CER C1005 JB 1H 472K-T	T	36.1/5.3
C53	4030017780	S.CER C1005 JB 1H 472K-T	T	37.0/9.4
C54	4030016930	S.CER C1005 JB 1A 104K-T	T	34.9/4.5
C55	4510008580	S.ELE EEEJ4A470SR	T	30.7/4.0
C56	4030016930	S.CER C1005 JB 1A 104K-T	T	34.9/2.9
C57	4030016930	S.CER C1005 JB 1A 104K-T	T	42.8/5.0
C58	4030016930	S.CER C1005 JB 1A 104K-T	T	41.0/5.9
C59	4030017720	S.CER C1005 JB 1H 331K-T	T	41.9/6.6
C60	4030017690	S.CER C1005 CH 1H 121J-T	T	42.2/7.8
C61	4030017720	S.CER C1005 JB 1H 331K-T	T	42.8/6.6
C62	4030016930	S.CER C1005 JB 1A 104K-T	T	35.7/6.5
C63	4030016930	S.CER C1005 JB 1A 104K-T	T	49.3/22.3
C64	4030017710	S.CER C1005 CH 1H 181J-T	T	34.7/6.5
C65	4030017710	S.CER C1005 CH 1H 181J-T	T	33.5/8.9
C101	4030017580	S.CER C1005 CH 1H 060C-T	T	26.5/8.7
C102	4030017660	S.CER C1005 CH 1H 330J-T	T	23.1/2.6
C104	4030017780	S.CER C1005 JB 1H 472K-T	T	20.9/7.8
C105	4030017460	S.CER C1005 JB 1H 102K-T	T	24.8/6.5
C120	4030017780	S.CER C1005 JB 1H 472K-T	T	37.3/11.6
C126	4030017780	S.CER C1005 JB 1H 472K-T	T	23.0/7.4
C150	4030017780	S.CER C1005 JB 1H 472K-T	T	44.1/10.7
C151	4030017780	S.CER C1005 JB 1H 472K-T	T	46.3/13.6
C152	4030017640	S.CER C1005 CH 1H 150J-T	T	43.3/16.0
C154	4030017660	S.CER C1005 CH 1H 330J-T	T	46.6/14.7
C155	4030017600	S.CER C1005 CH 1H 080C-T	T	46.4/16.8
C156	4030017660	S.CER C1005 CH 1H 330J-T	T	47.1/18.2
C157	4030007090	S.CER C1608 CH 1H 470J-T	B	53.0/15.3
C202	4030017590	S.CER C1005 CH 1H 070C-T	T	43.8/17.2
C203	4030007060	S.CER C1608 CH 1H 270J-T	B	37.8/16.0
C204	4030016930	S.CER C1005 JB 1A 104K-T	T	35.2/20.2
C206	4030017560	S.CER C1005 CH 1H 2R5B-T	T	43.4/21.7
C207	4030007110	S.CER C1608 CH 1H 680J-T	B	44.0/21.8
C208	4030009910	S.CER C1608 CH 1H 040B-T	B	40.9/21.8
C209	4030007060	S.CER C1608 CH 1H 270J-T	B	43.2/20.5
C210	4030009910	S.CER C1608 CH 1H 040B-T	B	40.8/19.8
C211	4030017460	S.CER C1005 JB 1H 102K-T	T	42.2/17.6
C216	4030017780	S.CER C1005 JB 1H 472K-T	T	46.3/20.9
C217	4030007120	S.CER C1608 CH 1H 820J-T	B	43.9/19.2
C218	4030011770	S.CER C1608 CH 1H 060B-T	B	43.2/17.9
C219	4030007010	S.CER C1608 CH 1H 100D-T	B	46.3/17.8
C221	4030006880	S.CER C1608 JB 1H 472K-T	B	46.1/15.1
C222	4030009910	S.CER C1608 CH 1H 040B-T	B	40.8/14.7
C223	4030006880	S.CER C1608 JB 1H 472K-T	B	46.0/13.5
C224	4030018630	S.CER C2012 CH 1H 472J-T	B	39.3/11.5
C225	4030006860	S.CER C1608 JB 1H 102K-T	B	38.5/19.4
C251	4030011600	S.CER C1608 JB 1E 104K-T	B	27.6/12.2
C252	4030011600	S.CER C1608 JB 1E 104K-T	B	28.7/23.5
C253	4550008160	S.TAN F931A226MAA [EUR]	B	29.6/21.7
Eqv.	4550007090	S.TAN TEESVA 1A 226M8R [EUR]		
C253	4550007090	S.TAN TEESVA 1A 226M8R [FRA]	B	29.6/21.7
Eqv.	4550008160	S.TAN F931A226MAA [FRA]		
C253	4550007090	S.TAN TEESVA 1A 226M8R [ESP]	B	29.6/21.7
Eqv.	4550008160	S.TAN F931A226MAA [ESP]		
C253	4550008160	S.TAN F931A226MAA [USA]	B	29.6/21.7
Eqv.	4550007090	S.TAN TEESVA 1A 226M8R [USA]		
C253	4550007090	S.TAN TEESVA 1A 226M8R [ITR]	B	29.6/21.7
Eqv.	4550008160	S.TAN F931A226MAA [ITR]		

Eqv.= This component is equivalent to the REF No. component listed above, and may be substituted on parts orders and repairs.

[DDS UNIT]

REF NO.	PARTS NO.	DESCRIPTION	M.	H/V LOCATION
C253	4550008160	S.TAN F931A226MAA [UK]	B	29.6/21.7
Eqv.	4550007090	S.TAN TEESVA 1A 226M8R [UK]		
C253	4550007090	S.TAN TEESVA 1A 226M8R [KOR]	B	29.6/21.7
Eqv.	4550008160	S.TAN F931A226MAA [KOR]		
C253	4550007090	S.TAN TEESVA 1A 226M8R [AUS]	B	29.6/21.7
Eqv.	4550008160	S.TAN F931A226MAA [AUS]		
C253	4550008160	S.TAN F931A226MAA [CHN]	B	29.6/21.7
Eqv.	4550007090	S.TAN TEESVA 1A 226M8R [CHN]		
C254	4030011600	S.CER C1608 JB 1E 104K-T	B	29.2/12.2
C255	4550008160	S.TAN F931A226MAA [EUR]	B	29.5/19.3
Eqv.	4550007090	S.TAN TEESVA 1A 226M8R [EUR]		
C255	4550007090	S.TAN TEESVA 1A 226M8R [FRA]	B	29.5/19.3
Eqv.	4550008160	S.TAN F931A226MAA [FRA]		
C255	4550007090	S.TAN TEESVA 1A 226M8R [ESP]	B	29.5/19.3
Eqv.	4550008160	S.TAN F931A226MAA [ESP]		
C255	4550008160	S.TAN F931A226MAA [USA]	B	29.5/19.3
Eqv.	4550007090	S.TAN TEESVA 1A 226M8R [USA]		
C255	4550007090	S.TAN TEESVA 1A 226M8R [ITR]	B	29.5/19.3
Eqv.	4550008160	S.TAN F931A226MAA [ITR]		
C255	4550008160	S.TAN F931A226MAA [UK]	B	29.5/19.3
Eqv.	4550007090	S.TAN TEESVA 1A 226M8R [UK]		
C255	4550007090	S.TAN TEESVA 1A 226M8R [KOR]	B	29.5/19.3
Eqv.	4550008160	S.TAN F931A226MAA [KOR]		
C255	4550007090	S.TAN TEESVA 1A 226M8R [AUS]	B	29.5/19.3
Eqv.	4550008160	S.TAN F931A226MAA [AUS]		
C255	4550008160	S.TAN F931A226MAA [CHN]	B	29.5/19.3
Eqv.	4550007090	S.TAN TEESVA 1A 226M8R [CHN]		
C302	4030016930	S.CER C1005 JB 1A 104K-T	T	36.2/22.2
C303	4030016930	S.CER C1005 JB 1A 104K-T	T	37.3/22.3
C304	4030016930	S.CER C1005 JB 1A 104K-T	T	38.2/22.2
C305	4030016930	S.CER C1005 JB 1A 104K-T	T	39.1/22.2
C306	4030016930	S.CER C1005 JB 1A 104K-T	T	43.6/24.6
C307	4030016930	S.CER C1005 JB 1A 104K-T	T	31.2/28.4
C308	4030016930	S.CER C1005 JB 1A 104K-T	T	43.6/25.5
C309	4030016930	S.CER C1005 JB 1A 104K-T	T	43.1/26.7
C310	4030016930	S.CER C1005 JB 1A 104K-T	T	44.0/26.7
C312	4030016930	S.CER C1005 JB 1A 104K-T	T	43.5/30.6
C317	4030011600	S.CER C1608 JB 1E 104K-T	B	44.0/26.1
C318	4030006880	S.CER C1608 JB 1H 472K-T	B	39.3/25.5
C321	4030017500	S.CER C1005 CH 1H 560J-T	T	51.3/30.2
C323	4030017510	S.CER C1005 CH 1H 680J-T	T	48.6/33.4
C325	4030017660	S.CER C1005 CH 1H 330J-T	T	48.8/35.8
C326	4030017640	S.CER C1005 CH 1H 150J-T	T	53.1/32.1
C328	4030006880	S.CER C1608 JB 1H 472K-T	B	39.7/29.7
C331	4030017390	S.CER C1005 CH 1H 180J-T	T	46.6/44.6
C333	4030017670	S.CER C1005 CH 1H 390J-T	T	48.4/44.5
C335	4030017390	S.CER C1005 CH 1H 180J-T	T	50.2/44.5
C341	4030007130	S.CER C1608 CH 1H 101J-T	B	42.5/39.8
C342	4030007090	S.CER C1608 CH 1H 470J-T	B	43.8/42.1
C343	4030007140	S.CER C1608 CH 1H 121J-T	B	41.3/39.0
C344	4030007100	S.CER C1608 CH 1H 560J-T	B	42.8/34.3
C345	4030017660	S.CER C1005 CH 1H 330J-T	T	45.5/37.9
C346	4030017660	S.CER C1005 CH 1H 330J-T	T	45.8/39.7
C347	4030006860	S.CER C1608 JB 1H 102K-T	B	48.5/31.7
C401	4030017460	S.CER C1005 JB 1H 102K-T	T	51.1/44.5
C402	4030017460	S.CER C1005 JB 1H 102K-T	T	52.4/49.0
C403	4030017430	S.CER C1005 CH 1H 101J-T	T	48.0/46.1
C411	4030017400	S.CER C1005 CH 1H 220J-T	T	48.2/49.8
C412	4030017630	S.CER C1005 CH 1H 120J-T	T	47.7/47.3
C413	4030017400	S.CER C1005 CH 1H 220J-T	T	46.7/49.3
C451	4030017420	S.CER C1005 CH 1H 470J-T	T	40.2/46.6
C453	4030017460	S.CER C1005 JB 1H 102K-T	T	46.1/46.8
C454	4030017460	S.CER C1005 JB 1H 102K-T	T	35.3/48.0
C456	4030016930	S.CER C1005 JB 1A 104K-T	T	31.3/48.0
C457	4030017460	S.CER C1005 JB 1H 102K-T	T	35.3/47.1
C458	4030017460	S.CER C1005 JB 1H 102K-T	T	30.6/49.8
C459	4030017460	S.CER C1005 JB 1H 102K-T	T	27.1/50.6
C460	4030017780	S.CER C1005 JB 1H 472K-T	T	39.4/50.1
C461	4030006880	S.CER C1608 JB 1H 472K-T	T	30.8/42.3
C463	4030017420	S.CER C1005 CH 1H 470J-T	T	40.7/41.9
C464	4030017690	S.CER C1005 CH 1H 121J-T	T	41.5/40.3
C465	4030017400	S.CER C1005 CH 1H 220J-T	T	37.8/41.8
C466	4030017570	S.CER C1005 CH 1H 040B-T	T	38.1/40.6
C467	4030017400	S.CER C1005 CH 1H 220J-T	T	37.2/40.6
C468	4030017360	S.CER C1005 CH 1H 030B-T	T	29.1/48.0
C469	4030017370	S.CER C1005 CH 1H 3R5B-T	T	29.1/47.1
C470	4030017380	S.CER C1005 CH 1H 050B-T	T	29.1/46.2
C471	4030017380	S.C		

[DDS UNIT]

REF NO.	PARTS NO.	DESCRIPTION	M.	H/V LOCATION
C555	4030017670	S.CER C1005 CH 1H 390J-T	T	14.5/42.0
C556	4030017350	S.CER C1005 CH 1H 020B-T	T	14.0/43.2
C557	4030017420	S.CER C1005 CH 1H 470J-T	T	13.2/42.0
C558	4030017590	S.CER C1005 CH 1H 070C-T	T	10.0/43.2
C559	4030017420	S.CER C1005 CH 1H 470J-T	T	8.9/42.0
C560	4030017630	S.CER C1005 CH 1H 120J-T	T	8.4/43.2
C561	4030017660	S.CER C1005 CH 1H 330J-T	T	7.9/42.0
C562	4030017780	S.CER C1005 JB 1H 472K-T	T	5.0/45.4
C563	4030017780	S.CER C1005 JB 1H 472K-T	T	11.7/41.6
C601	4030017780	S.CER C1005 JB 1H 472K-T	T	24.7/39.9
C602	4030017400	S.CER C1005 CH 1H 220J-T	T	23.3/37.6
C603	4030017360	S.CER C1005 CH 1H 030B-T	T	21.9/37.8
C604	4030017630	S.CER C1005 CH 1H 120J-T	T	13.3/40.4
C605	4030017620	S.CER C1005 CH 1H 100C-T	T	11.7/40.4
C606	4030017660	S.CER C1005 CH 1H 330J-T	T	18.4/36.9
C607	4030017600	S.CER C1005 CH 1H 080C-T	T	17.8/38.1
C608	4030017650	S.CER C1005 CH 1H 270J-T	T	17.2/36.9
C609	4030017640	S.CER C1005 CH 1H 150J-T	T	16.2/38.1
C610	4030017640	S.CER C1005 CH 1H 150J-T	T	15.9/36.9
C611	4030017440	S.CER C1005 CH 1H 221J-T	T	12.2/39.5
C612	4030017510	S.CER C1005 CH 1H 680J-T	T	10.3/40.0
C613	4030017620	S.CER C1005 CH 1H 100C-T	T	8.2/40.1
C614	4030017640	S.CER C1005 CH 1H 150J-T	T	5.4/40.4
C615	4030017670	S.CER C1005 CH 1H 390J-T	T	6.9/40.0
C616	4030017780	S.CER C1005 JB 1H 472K-T	T	6.9/38.2
C617	4030017780	S.CER C1005 JB 1H 472K-T	T	22.0/36.4
C618	4030017650	S.CER C1005 CH 1H 270J-T	T	3.4/37.2
C651	4030017620	S.CER C1005 CH 1H 100C-T	T	24.6/34.8
C652	4030017450	S.CER C1005 JB 1H 271K-T	T	23.7/34.8
C653	4030017590	S.CER C1005 CH 1H 070C-T	T	21.7/35.2
C654	4030017680	S.CER C1005 CH 1H 820J-T	T	20.4/34.8
C655	4030017600	S.CER C1005 CH 1H 080C-T	T	19.2/35.2
C656	4030017420	S.CER C1005 CH 1H 470J-T	T	17.9/34.8
C657	4030017630	S.CER C1005 CH 1H 120J-T	T	16.5/35.2
C658	4030017340	S.CER C1005 CH 1H 010B-T	T	13.3/32.8
C659	4030017360	S.CER C1005 CH 1H 030B-T	T	9.4/32.6
C660	4030017640	S.CER C1005 CH 1H 150J-T	T	14.6/32.3
C661	4030017650	S.CER C1005 CH 1H 270J-T	T	12.8/31.6
C662	4030017400	S.CER C1005 CH 1H 220J-T	T	8.5/31.6
C663	4030017380	S.CER C1005 CH 1H 050B-T	T	8.0/32.8
C664	4030017460	S.CER C1005 JB 1H 102K-T	T	5.4/34.9
C665	4030017390	S.CER C1005 CH 1H 180J-T	T	7.6/31.6
C666	4030017780	S.CER C1005 JB 1H 472K-T	T	11.5/31.2
C701	4030017460	S.CER C1005 JB 1H 102K-T	T	25.1/29.4
C702	4030017640	S.CER C1005 CH 1H 150J-T	T	23.7/27.2
C703	4030017540	S.CER C1005 CH 1H R75B-T	T	22.3/27.5
C704	4030017650	S.CER C1005 CH 1H 270J-T	T	18.7/26.4
C705	4030017350	S.CER C1005 CH 1H 020B-T	T	18.2/27.7
C706	4030017400	S.CER C1005 CH 1H 220J-T	T	17.5/26.4
C707	4030017570	S.CER C1005 CH 1H 040B-T	T	16.6/27.7
C708	4030017390	S.CER C1005 CH 1H 180J-T	T	16.4/26.4
C709	4030017590	S.CER C1005 CH 1H 070C-T	T	14.0/30.0
C710	4030017500	S.CER C1005 CH 1H 560J-T	T	12.6/29.1
C711	4030017380	S.CER C1005 CH 1H 050B-T	T	12.0/30.0
C712	4030017500	S.CER C1005 CH 1H 560J-T	T	10.7/29.3
C713	4030017380	S.CER C1005 CH 1H 050B-T	T	9.5/29.6
C714	4030017710	S.CER C1005 CH 1H 181J-T	T	8.2/29.7
C715	4030017630	S.CER C1005 CH 1H 120J-T	T	7.0/29.4
C716	4030017780	S.CER C1005 JB 1H 472K-T	T	21.5/26.0
C717	4030017460	S.CER C1005 JB 1H 102K-T	T	5.4/29.4
C751	4030017590	S.CER C1005 CH 1H 070C-T	T	24.9/24.5
C752	4030017710	S.CER C1005 CH 1H 181J-T	T	24.0/24.5
C753	4030017380	S.CER C1005 CH 1H 050B-T	T	21.5/24.9
C754	4030017500	S.CER C1005 CH 1H 560J-T	T	20.5/24.0
C755	4030017380	S.CER C1005 CH 1H 050B-T	T	19.9/24.9
C756	4030017650	S.CER C1005 CH 1H 270J-T	T	18.7/24.4
C757	4030017600	S.CER C1005 CH 1H 080C-T	T	16.7/24.8
C758	4030017610	S.CER C1005 CH 1H 090C-T	T	15.0/21.9
C759	4030017530	S.CER C1005 CH 1H 0R5B-T	T	14.1/22.2
C760	4030017640	S.CER C1005 CH 1H 150J-T	T	13.2/21.9
C761	4030017350	S.CER C1005 CH 1H 020B-T	T	9.7/22.2
C762	4030017630	S.CER C1005 CH 1H 120J-T	T	8.6/21.2
C763	4030017360	S.CER C1005 CH 1H 030B-T	T	8.2/22.4
C764	4030017620	S.CER C1005 CH 1H 100C-T	T	7.7/21.2
C765	4030017460	S.CER C1005 JB 1H 102K-T	T	5.4/24.7
C766	4030017780	S.CER C1005 JB 1H 472K-T	T	11.9/20.8
C802	4030017590	S.CER C1005 CH 1H 070C-T	T	26.5/19.4
C803	4030017380	S.CER C1005 CH 1H 050B-T	T	25.2/18.9
C804	4030017570	S.CER C1005 CH 1H 040B-T	T	24.3/18.9
C806	4030017600	S.CER C1005 CH 1H 080C-T	T	24.3/17.2
C807	4030017360	S.CER C1005 CH 1H 030B-T	T	23.4/19.0
C808	4030017660	S.CER C1005 CH 1H 330J-T	T	23.0/16.8
C809	4030017570	S.CER C1005 CH 1H 040B-T	T	23.0/17.7
C810	4030017570	S.CER C1005 CH 1H 040B-T	T	21.7/16.7
C811	4030017590	S.CER C1005 CH 1H 070C-T	T	21.3/18.0
C812	4030017610	S.CER C1005 CH 1H 090C-T	T	20.8/16.7
C813	4030017350	S.CER C1005 CH 1H 020B-T	T	19.8/18.8
C814	4030017580	S.CER C1005 CH 1H 060C-T	T	19.8/17.1
C815	4030017460	S.CER C1005 JB 1H 102K-T	T	20.3/12.6
C816	4030017460	S.CER C1005 JB 1H 102K-T	T	15.2/10.8
C817	4030017730	S.CER C1005 JB 1H 471K-T	T	19.0/9.0
C824	4030017590	S.CER C1005 CH 1H 070C-T	T	13.1/13.1
C825	4030017380	S.CER C1005 CH 1H 050B-T	T	14.3/13.4
C826	4030017570	S.CER C1005 CH 1H 040B-T	T	13.1/15.1
C827	4030017620	S.CER C1005 CH 1H 100C-T	T	14.6/15.6
C828	4030017360	S.CER C1005 CH 1H 030B-T	T	13.9/16.5
C829	4030017660	S.CER C1005 CH 1H 330J-T	T	12.7/16.9
C830	4030017570	S.CER C1005 CH 1H 040B-T	T	11.8/17.7
C831	4030017570	S.CER C1005 CH 1H 040B-T	T	11.8/19.3
C832	4030017590	S.CER C1005 CH 1H 070C-T	T	10.3/19.1
C833	4030017610	S.CER C1005 CH 1H 090C-T	T	8.5/19.2
C834	4030017350	S.CER C1005 CH 1H 020B-T	T	8.0/17.9
C835	4030017580	S.CER C1005 CH 1H 060C-T	T	7.1/19.6
C838	4030017460	S.CER C1005 JB 1H 102K-T	T	5.4/19.6
C839	4030017780	S.CER C1005 JB 1H 472K-T	T	25.5/14.6

Eqv.= This component is equivalent to the REF No. component listed above, and may be substituted on parts orders and repairs.

[DDS UNIT]

REF NO.	PARTS NO.	DESCRIPTION	M.	H/V LOCATION
C840	4030017460	S.CER C1005 JB 1H 102K-T	T	6.6/15.7
C841	4030006860	S.CER C1608 JB 1H 102K-T	B	5.1/15.4
C851	4030017780	S.CER C1005 JB 1H 472K-T	T	4.5/14.0
C901	4030017780	S.CER C1005 JB 1H 472K-T	T	2.4/68.4
C902	4030017430	S.CER C1005 CH 1H 101J-T	T	16.0/53.3
C951	4030016930	S.CER C1005 JB 1A 104K-T	T	52.3/38.2
C952	4030011600	S.CER C1608 JB 1E 104K-T	T	58.3/47.0
C953	4030016930	S.CER C1005 JB 1A 104K-T	T	54.1/18.4
C954	4030017780	S.CER C1005 JB 1H 472K-T	T	54.2/28.1
C955	4030016930	S.CER C1005 JB 1A 104K-T	T	52.9/33.3
C956	4030016930	S.CER C1005 JB 1A 104K-T	T	49.2/21.0
C957	4030016930	S.CER C1005 JB 1A 104K-T	T	53.9/36.0
C958	4030017780	S.CER C1005 JB 1H 472K-T	T	52.9/34.2
C959	4030017780	S.CER C1005 JB 1H 472K-T	T	52.9/35.1
C960	4030016930	S.CER C1005 JB 1A 104K-T	T	53.5/39.0
C961	4030016930	S.CER C1005 JB 1A 104K-T	T	52.3/39.8
C962	4030016930	S.CER C1005 JB 1A 104K-T	T	52.3/44.6
C963	4030016930	S.CER C1005 JB 1A 104K-T	T	53.5/38.1
C964	4030017460	S.CER C1005 JB 1H 102K-T	T	55.0/44.8
C966	4030016930	S.CER C1005 JB 1A 104K-T	T	52.3/41.4
C967	4030016930	S.CER C1005 JB 1A 104K-T	T	52.3/43.0
C968	4030018960	S.CER C3216 JB 1C 106MT-N	B	42.1/44.0
C969	4030006880	S.CER C1608 JB 1H 472K-T	B	48.2/23.1
C972	4030018970	S.CER C3225 JB 1C 226MT-N	B	42.2/36.2
C973	4030018970	S.CER C3225 JB 1C 226MT-N	B	29.0/2.8
C974	4030018970	S.CER C3225 JB 1C 226MT-N	B	32.0/2.8
C975	4550008190	S.TAN F931C107MNC [EUR]	B	16.7/4.1
Eqv.	4550007140	S.TAN TEESVD 1C 107M12R [EUR]		
C975	4550007140	S.TAN TEESVD 1C 107M12R [FRA]	B	16.7/4.1
Eqv.	4550008190	S.TAN F931C107MNC [FRA]		
C975	4550007140	S.TAN TEESVD 1C 107M12R [ESP]	B	16.7/4.1
Eqv.	4550008190	S.TAN F931C107MNC [ESP]		
C975	4550008190	S.TAN F931C107MNC [USA]	B	16.7/4.1
Eqv.	4550007140	S.TAN TEESVD 1C 107M12R [USA]		
C975	4550007140	S.TAN TEESVD 1C 107M12R [ITR]	B	16.7/4.1
Eqv.	4550008190	S.TAN F931C107MNC [ITR]		
C975	4550008190	S.TAN F931C107MNC [UK]	B	16.7/4.1
Eqv.	4550007140	S.TAN TEESVD 1C 107M12R [UK]		
C975	4550007140	S.TAN TEESVD 1C 107M12R [KOR]	B	16.7/4.1
Eqv.	4550008190	S.TAN F931C107MNC [KOR]		
C975	4550007140	S.TAN TEESVD 1C 107M12R [AUS]	B	16.7/4.1
Eqv.	4550008190	S.TAN F931C107MNC [AUS]		
C975	4550008190	S.TAN F931C107MNC [CHN]	B	16.7/4.1
Eqv.	4550007140	S.TAN TEESVD 1C 107M12R [CHN]		
C976	4550008190	S.TAN F931C107MNC [EUR]	B	23.5/10.5
Eqv.	4550007140	S.TAN TEESVD 1C 107M12R [EUR]		
C976	4550007140	S.TAN TEESVD 1C 107M12R [FRA]	B	23.5/10.5
Eqv.	4550008190	S.TAN F931C107MNC [FRA]		
C976	4550007140	S.TAN TEESVD 1C 107M12R [ESP]	B	23.5/10.5
Eqv.	4550008190	S.TAN F931C107MNC [ESP]		
C976	4550008190	S.TAN F931C107MNC [USA]	B	23.5/10.5
Eqv.	4550007140	S.TAN TEESVD 1C 107M12R [USA]		
C976	4550007140	S.TAN TEESVD 1C 107M12R [ITR]	B	23.5/10.5
Eqv.	4550008190	S.TAN F931C107MNC [ITR]		
C976	4550008190	S.TAN F931C107MNC [UK]	B	23.5/10.5
Eqv.	4550007140	S.TAN TEESVD 1C 107M12R [UK]		
C976	4550007140	S.TAN TEESVD 1C 107M12R [KOR]	B	23.5/10.5
Eqv.	4550008190	S.TAN F931C107MNC [KOR]		
C976	4550007140	S.TAN TEESVD 1C 107M12R [AUS]	B	23.5/10.5
Eqv.	4550008190	S.TAN F931C107MNC [AUS]		
C976	4550008190	S.TAN F931C107MNC [CHN]	B	23.5/10.5
Eqv.	4550007140	S.TAN TEESVD 1C 107M12R [CHN]		
C977	4550008190	S.TAN F931C107MNC [EUR]	B	23.6/19.5
Eqv.	4550007140	S.TAN TEESVD 1C 107M12R [EUR]		
C977	4550007140	S.TAN TEESVD 1C 107M12R [FRA]	B	23.6/19.5
Eqv.	4550008190	S.TAN F931C107MNC [FRA]		
C977	4550007140	S.TAN TEESVD 1C 107M12R [ESP]	B	23.6/19.5
Eqv.	4550008190	S.TAN F931C107MNC [ESP]		
C977	4550008190	S.TAN F931C107MNC [USA]	B	23.6/19.5
Eqv.	4550007140	S.TAN TEESVD 1C 107M12R [USA]		
C977	4550007140	S.TAN TEESVD 1C 107M12R [ITR]	B	23.6/19.5
Eqv.	4550008190	S.TAN F931C107MNC [ITR]		
C977	4550008190	S.TAN F931C107MNC [UK]	B	23.6/19.5
Eqv.	4550007140	S.TAN TEESVD 1C 107M		

[DDS UNIT]

REF NO.	PARTS NO.	DESCRIPTION	M.	H/V LOCATION
C994	4030006860	S.CER C1608 JB 1H 102K-T	B	5.6/71.4
C995	4030006860	S.CER C1608 JB 1H 102K-T	B	2.2/59.2
C996	4030006860	S.CER C1608 JB 1H 102K-T	B	5.1/58.8
C997	4030006860	S.CER C1608 JB 1H 102K-T	B	2.9/55.0
C998	4030006860	S.CER C1608 JB 1H 102K-T	B	3.1/62.6
C1001	4030011600	S.CER C1608 JB 1E 104K-T	T	58.4/48.4
C1051	4030006880	S.CER C1608 JB 1H 472K-T	B	20.2/65.4
C1052	4030006880	S.CER C1608 JB 1H 472K-T	B	19.2/60.3
C1101	4030017780	S.CER C1005 JB 1H 472K-T	T	39.0/52.2
C1102	4030017780	S.CER C1005 JB 1H 472K-T	T	44.2/50.4
C1104	4030017780	S.CER C1005 JB 1H 472K-T	T	42.2/62.2
C1105	4030017780	S.CER C1005 JB 1H 472K-T	T	40.6/59.9
C1106	4030017780	S.CER C1005 JB 1H 472K-T	T	40.4/55.9
C1107	4030017780	S.CER C1005 JB 1H 472K-T	T	43.3/57.0
C1108	4030017460	S.CER C1005 JB 1H 102K-T	T	40.1/62.2
C1109	4030006880	S.CER C1608 JB 1H 472K-T	B	35.1/76.9
C1110	4030017780	S.CER C1005 JB 1H 472K-T	T	33.5/59.6
C1111	4030017780	S.CER C1005 JB 1H 472K-T	T	29.7/59.6
C1112	4030017780	S.CER C1005 JB 1H 472K-T	T	38.2/63.4
C1113	4030017780	S.CER C1005 JB 1H 472K-T	T	37.1/59.7
C1114	4030017780	S.CER C1005 JB 1H 472K-T	T	24.4/60.7
C1115	4030017780	S.CER C1005 JB 1H 472K-T	T	35.3/59.8
C1116	4030017460	S.CER C1005 JB 1H 102K-T	T	23.2/63.8
C1117	4030006860	S.CER C1608 JB 1H 102K-T	B	21.0/63.9
C1151	4030017780	S.CER C1005 JB 1H 472K-T	T	50.5/66.3
C1152	4030017780	S.CER C1005 JB 1H 472K-T	T	46.4/66.3
C1153	4030017780	S.CER C1005 JB 1H 472K-T	T	43.7/68.2
C1154	4030017780	S.CER C1005 JB 1H 472K-T	T	52.0/66.3
C1155	4030017780	S.CER C1005 JB 1H 472K-T	T	57.9/68.3
RL1101	6330001721	REL ATN207-K1		
J151	6510028210	CON SJ050010 (TMP-J01X-V6)		
J851	6510018450	CON TMP-S01X-B1		
J951	6510024880	S.CON 52689-3087	T	59.3/35.4
J952	6510024880	S.CON 52689-3087	T	59.3/12.5
J1001	6510003521	CON S04B-EH-S(LF)(SN)		
J1051	6510028070	CON 01J0377-00		
J1101	6450001641	CON TCS5044-0141177		
J1151	6450001841	CON TCS7568-4320177		
EP6	6910012350	S.BEA MMZ1608Y 102BT	B	12.9/11.1
EP251	6910012350	S.BEA MMZ1608Y 102BT	B	33.1/18.7
EP301	6910012350	S.BEA MMZ1608Y 102BT	B	49.8/25.0
EP302	6910012350	S.BEA MMZ1608Y 102BT	B	32.9/27.8
EP303	6910012350	S.BEA MMZ1608Y 102BT	B	32.9/26.1
EP305	6910012350	S.BEA MMZ1608Y 102BT	B	41.1/27.2
EP306	6910012350	S.BEA MMZ1608Y 102BT	B	36.6/26.4
EP451	6910012350	S.BEA MMZ1608Y 102BT	B	39.9/47.9
EP809	6910012350	S.BEA MMZ1608Y 102BT	B	16.7/7.2
EP951	6910012350	S.BEA MMZ1608Y 102BT	B	53.3/24.4
EP952	6910012350	S.BEA MMZ1608Y 102BT	B	50.6/21.8
EP953	6910012350	S.BEA MMZ1608Y 102BT	T	54.0/43.4
EP954	6910012350	S.BEA MMZ1608Y 102BT	T	54.0/42.1
EP955	6910012350	S.BEA MMZ1608Y 102BT	T	54.2/40.0
EP956	6910012350	S.BEA MMZ1608Y 102BT	T	54.7/37.0
EP957	6910012350	S.BEA MMZ1608Y 102BT	B	39.6/46.1
EP958	6910012350	S.BEA MMZ1608Y 102BT	B	55.9/47.4
EP959	6910012350	S.BEA MMZ1608Y 102BT	B	56.7/32.5
EP960	6910012350	S.BEA MMZ1608Y 102BT	B	56.9/28.4
EP964	6910012350	S.BEA MMZ1608Y 102BT	B	53.4/22.2
EP981	6910012350	S.BEA MMZ1608Y 102BT	T	55.3/14.3
EP1003	6910018930	S.BEA MPZ2012S601A	T	57.3/50.3
EP1004	6910018930	S.BEA MPZ2012S601A	T	53.9/50.0
EP1051	6910012350	S.BEA MMZ1608Y 102BT	B	20.2/66.8
EP1052	6910012350	S.BEA MMZ1608Y 102BT	B	19.2/58.7
EP1100	6910012350	S.BEA MMZ1608Y 102BT	B	38.7/63.4
EP1101	6910012350	S.BEA MMZ1608Y 102BT	T	27.5/63.3
EP1102	6910012350	S.BEA MMZ1608Y 102BT	T	34.4/62.4
EP1103	6910012350	S.BEA MMZ1608Y 102BT	T	51.1/69.2
EP1104	6910012350	S.BEA MMZ1608Y 102BT	T	56.1/69.2
EP1105	6910014730	S.BEA MPZ2012S331A-T	B	41.0/67.9
EP1106	6910014730	S.BEA MPZ2012S331A-T	B	34.7/61.8
EP1107	6910014730	S.BEA MPZ2012S331A-T	B	31.4/61.8
EP1108	6910014730	S.BEA MPZ2012S331A-T	B	27.1/73.6

Eqv.= This component is equivalent to the REF No. component listed above, and may be substituted on parts orders and repairs.

M.=Mounted side (T: Mounted on the Top side, B: Mounted on the Bottom side)
S.=Surface mount

• PA UNIT B-6251Q
(BOTTOM VIEW)

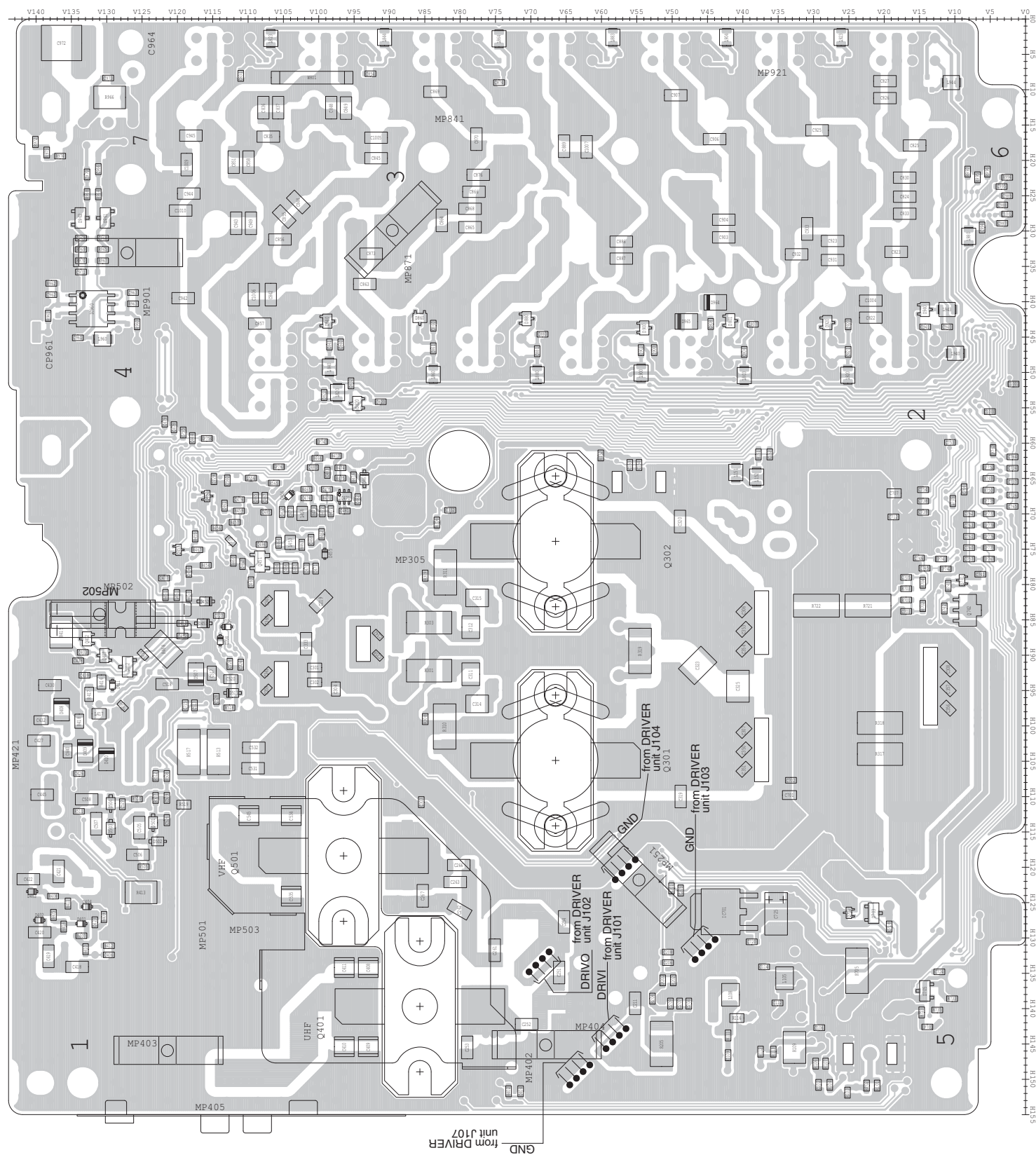

• LOGIC UNIT B-6250M
(BOTTOM VIEW)

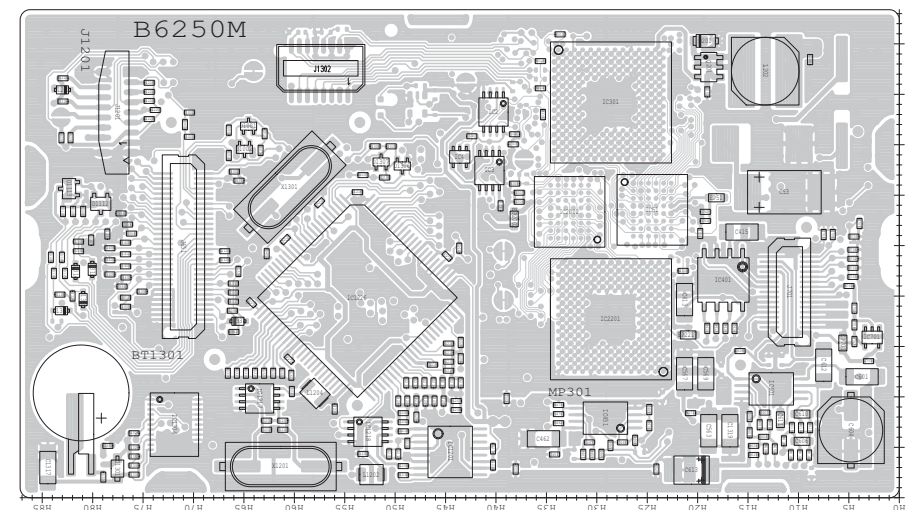

J651

60	1DST	VDL	1
	3DST	MMDK	
	PDT	SQSS	
	PCK	DOTK	
	TCNO	DASK	
	TCN1	WFML	
	PRES#	LTXD	
	LOST	LTXD	
	RS_RXD	CIV	
	RS_TXD	CIVE	
	MST	START	
	MDT	KEY	
	MCK	MUDL	
	NC	FOFL	
	SNDS	REFL	
	SDSS	ALCL	
	2T8V	SNDL	
	4T8V	DFTL	
	TXS	THML	
	RXS	CPU_P12	
	POWS	RTK1	
	VOUT	CPU_P22	
	PWRK	CPU_P94	
	GND	CPU_P95	
	GND	IMR	
</			

• DISPLAY UNIT B-6245K
(TOP VIEW)

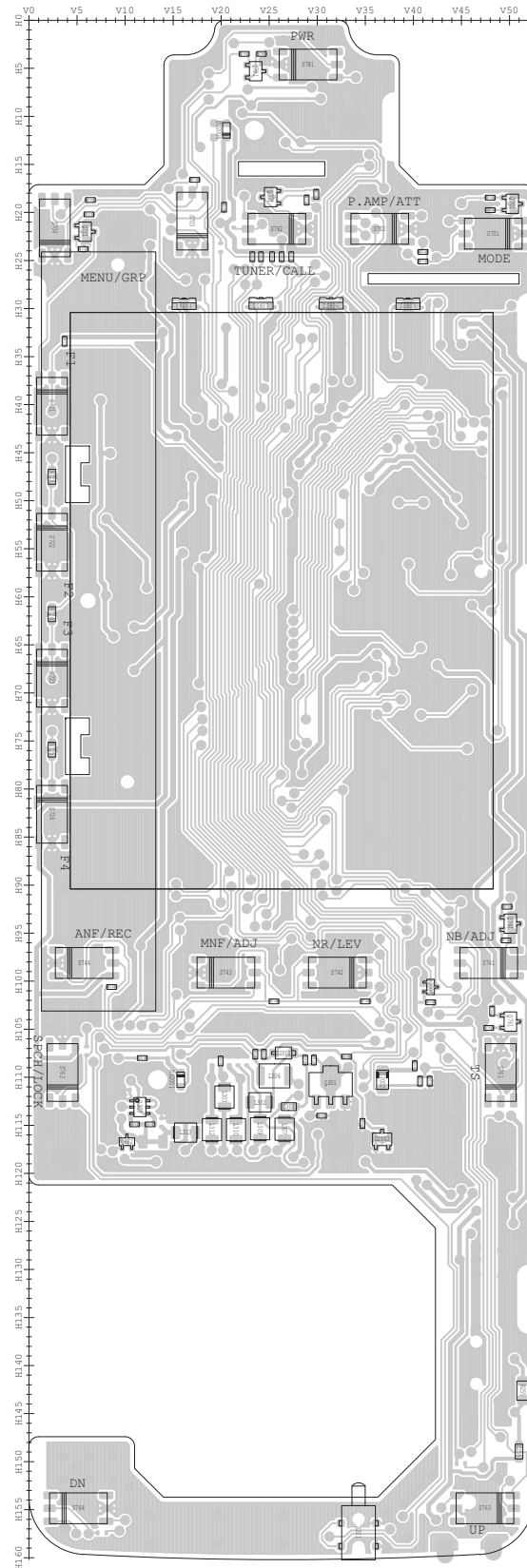

• DDS UNIT B-6673D
(TOP VIEW)

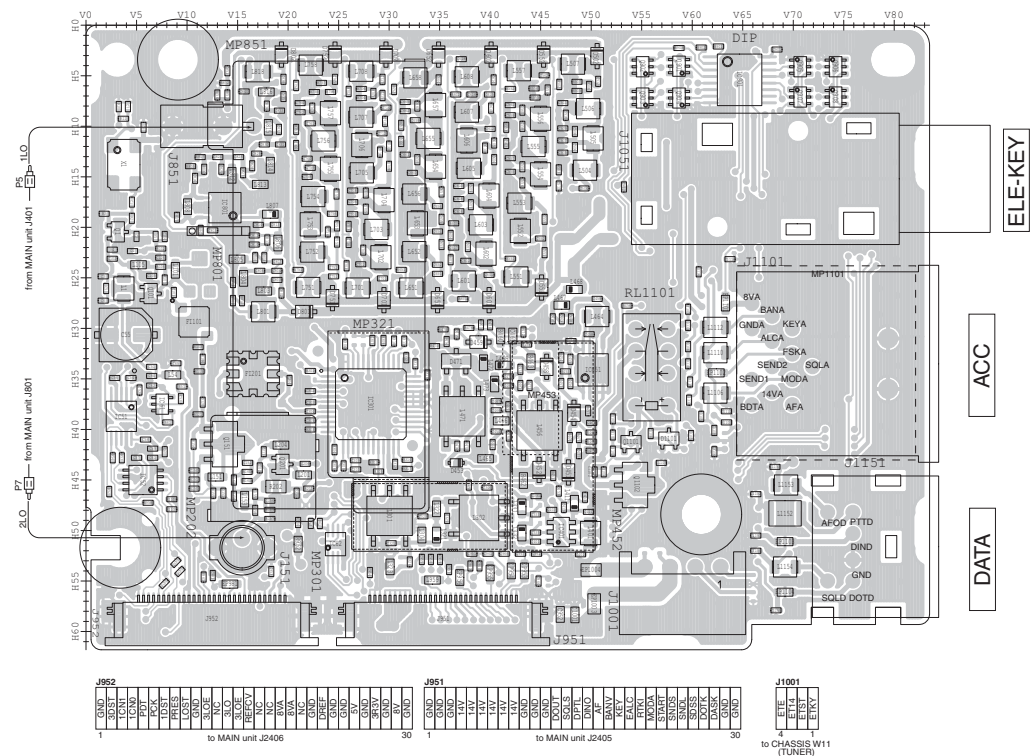

• LOGIC UNIT (3/3)

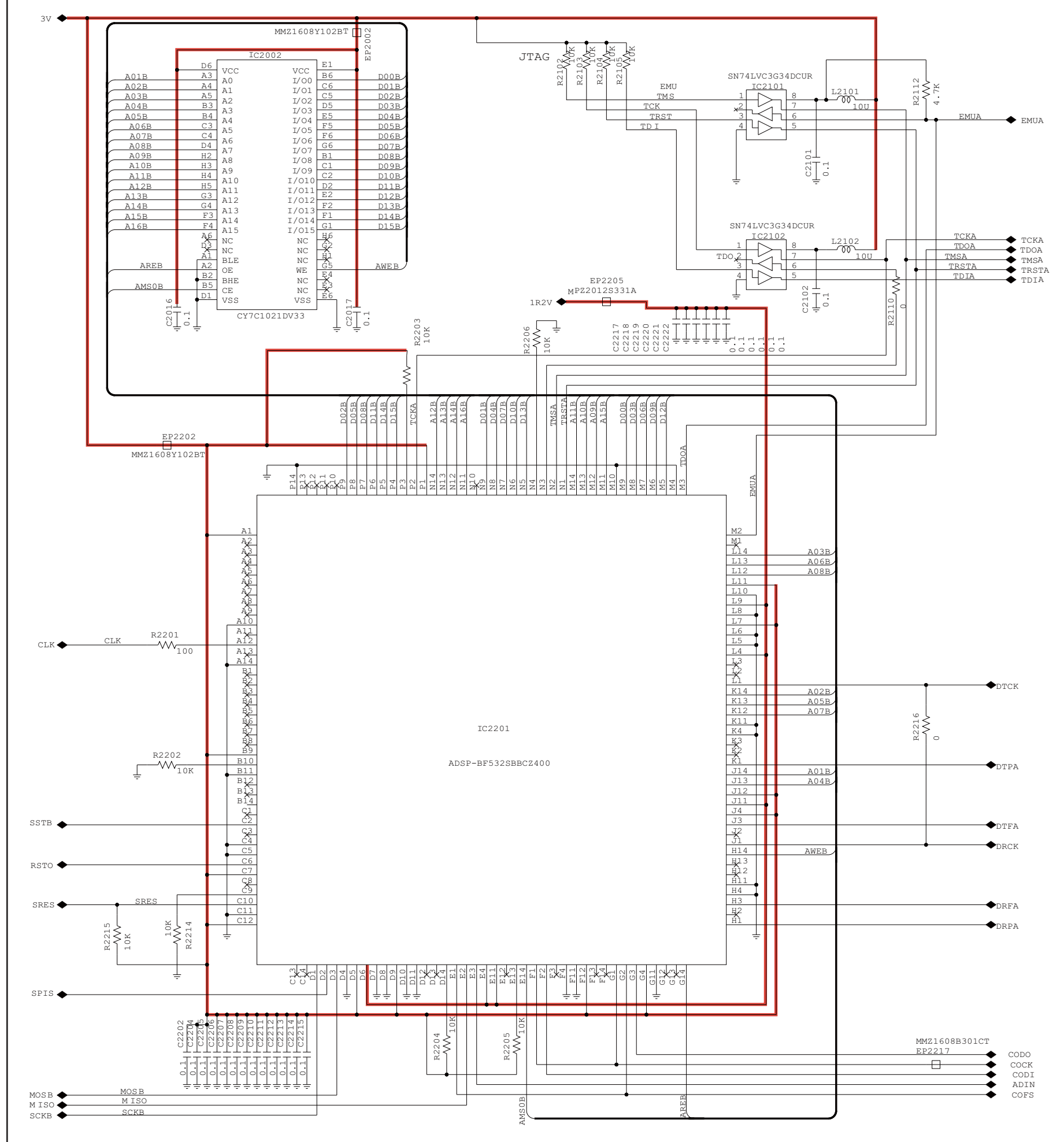

*; Refer to "PARTS LIST."

• MAIN UNIT (1/3)

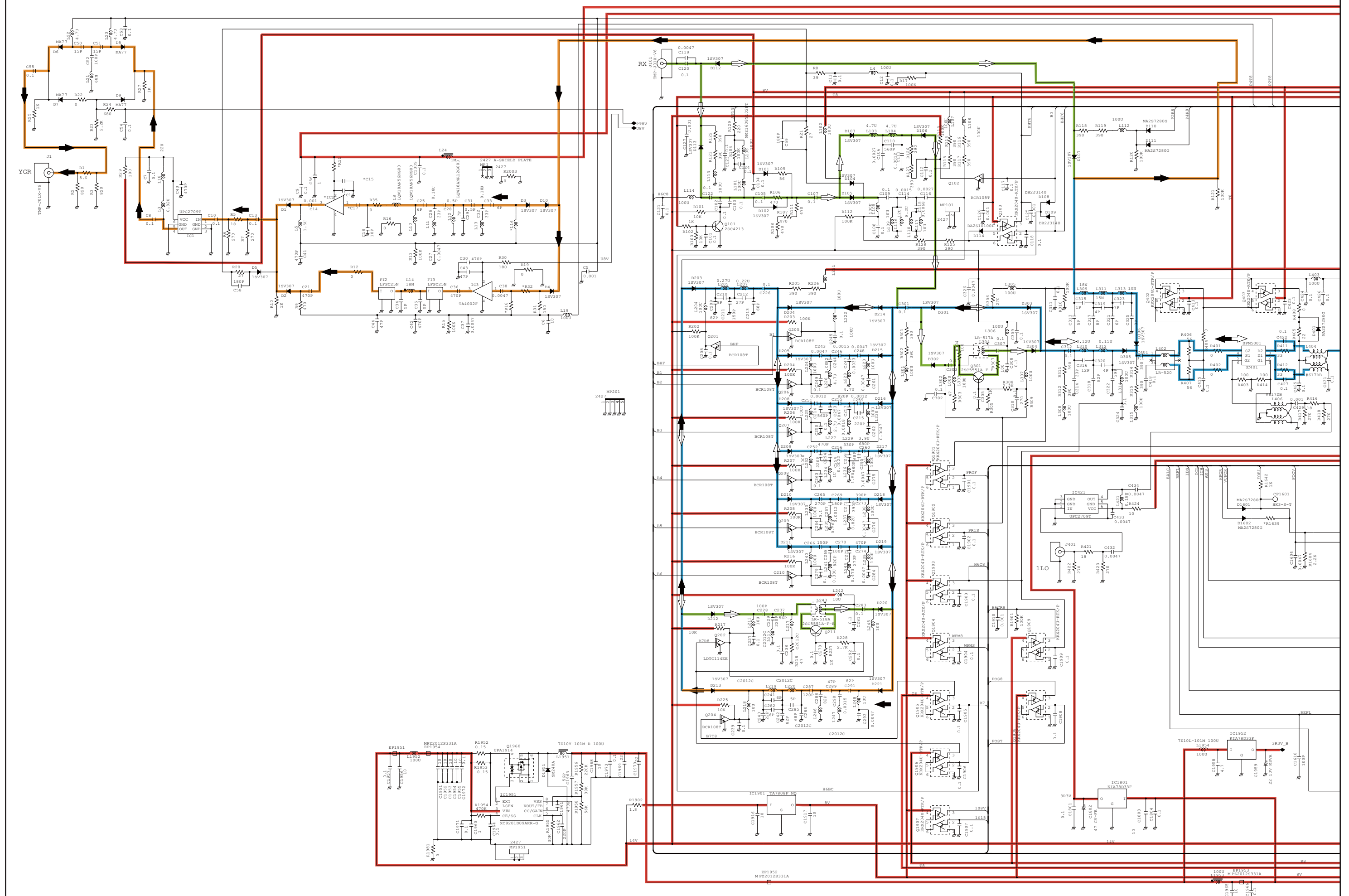

*; Refer to "PARTS LIST."

• MAIN UNIT (2/3)

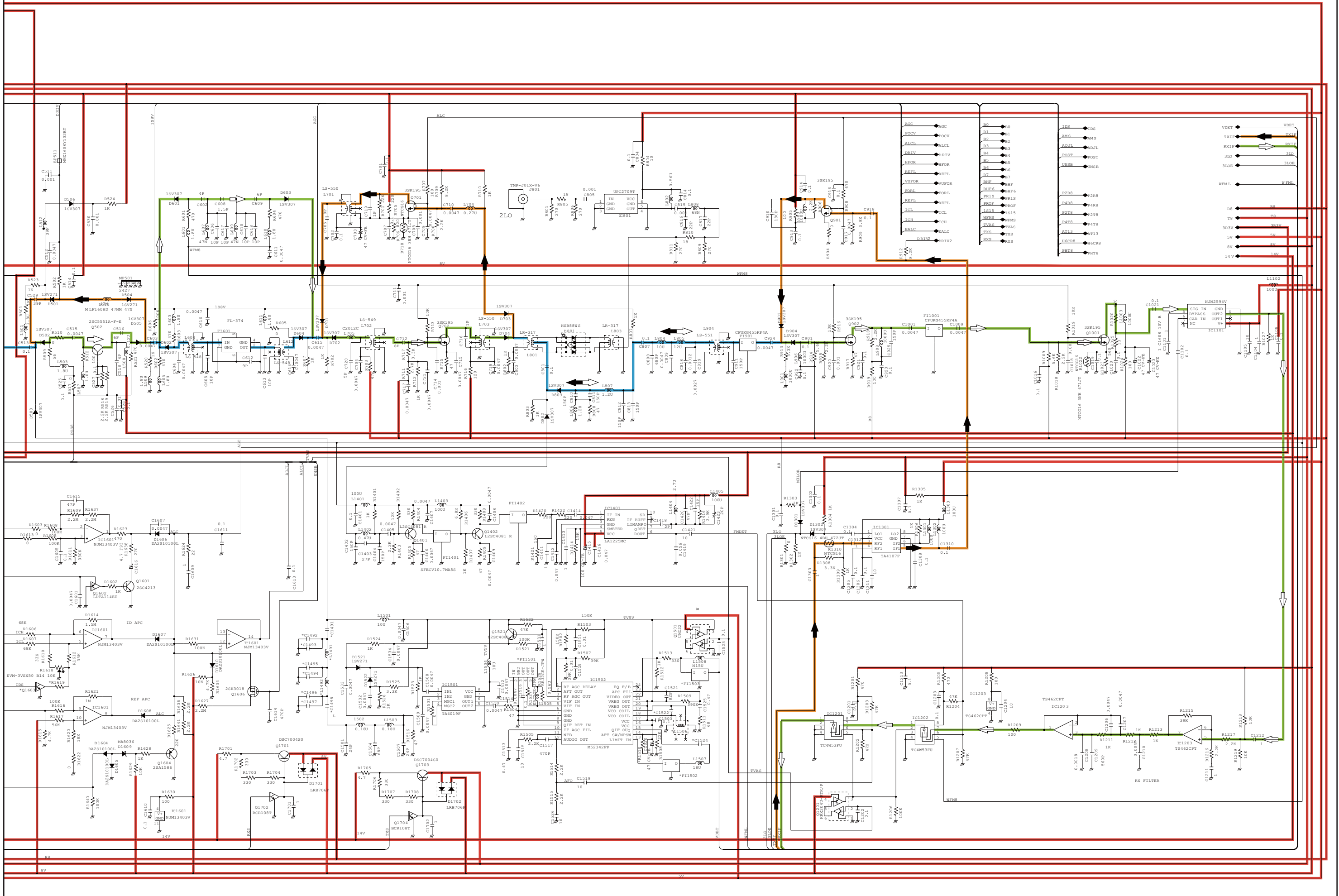

*; Refer to "PARTS LIST"

Feb. 2012



SERVICE MANUAL ADDENDUM

IC-7000

CONTENTS

PARTS LIST	1
BOARD LAYOUTS	26
VOLTAGE DIAGRAM	28

PARTS LIST

[MAIN UNIT]

REF NO.	PARTS NO.	DESCRIPTION	M.	H/V LOCATION
IC1	1110004080	S.IC UPC2709T-E3	T	75.7/12.8
IC2	1110004101	S.IC TA4001F (TE85LF)	T	64.1/18.8
IC3	1110004091	S.IC TA4002F (TE85LF)	T	48.3/17.4
IC801	1110004080	S.IC UPC2709T-E3	T	86.0/57.5
	1130016260	S.IC BR24T64FVT-WE2	[EUR]	
	1110004080	S.IC UPC2709T-E3	[FRA]	
	1110004080	S.IC UPC2709T-E3	[ESP]	
	1110004080	S.IC UPC2709T-E3	[USA]	
	1110004080	S.IC UPC2709T-E3	[UK]	
	1110004080	S.IC UPC2709T-E3	[KOR]	
	1110004080	S.IC UPC2709T-E3	[AUS]	
	1110004080	S.IC UPC2709T-E3	[CHN]	
IC1101	1110006730	S.IC NJM2594V-TE1-#ZZZB	T	5.0/83.4
IC1201	1130006221	S.IC TC4W53FU(TE12LF)	T	24.2/81.6
IC1202	1130006221	S.IC TC4W53FU(TE12LF)	T	19.8/81.4
IC1203	1110006570	S.IC TS462CPT	T	12.8/81.8
IC1301	1110005461	S.IC TA4107F(TE12LF)	T	13.7/63.4
IC1401	1110006541	S.IC LA1225M-TLM-E	B	23.4/82.2
IC1501	1110006530	S.IC TA4019F(TE12LF)	B	74.9/39.1
IC1502	1110005040	S.IC M52342FP 600C	B	79.7/57.0
IC1601	1110005320	S.IC NJM13403V-TE1-#ZZZB	T	8.6/41.5
IC1801	1180002020	S.REG BA033FP-E2	B	22.9/106.6
IC1901	1180001252	S.IC TA7808F(TE16L1NQ)	B	10.4/55.2
IC1951	1190002121	S.IC XC9201D09AKR-G	B	42.0/107.8
IC1952	1180002020	S.REG BA033FP-E2	B	14.7/125.9
IC2001	1180001252	S.IC TA7808F(TE16L1NQ)	B	8.5/19.1
IC2007	1110006570	S.IC TS462CPT	T	15.9/121.0
IC2101	1110005320	S.IC NJM13403V-TE1-#ZZZB	T	28.5/118.1
IC2102	1110005320	S.IC NJM13403V-TE1-#ZZZB	T	49.5/111.9
IC2103	1110005140	S.IC NJM3403AV-TE1-#ZZZB	T	49.5/121.2
IC2151	1130012720	S.IC CD74HC4094PWR	T	47.2/95.9
IC2152	1130012720	S.IC CD74HC4094PWR	T	37.9/95.9
IC2153	1130012720	S.IC CD74HC4094PWR	T	28.1/95.9
IC2154	1130012720	S.IC CD74HC4094PWR	T	28.2/101.5
IC2155	1110006680	S.IC BH2221FV-E2	T	38.2/118.1
IC2156	1130009100	S.IC BU4052BCFV-E2	T	10.2/107.7
IC2231	1110006640	S.IC NJM2244M-TE1-#ZZZB	T	34.8/109.4
IC2251	1130008511	S.IC TC7W53FU(TE12LF)	T	16.8/89.6
IC2501	1110006570	S.IC TS462CPT	B	12.8/91.8
IC2551	1110006570	S.IC TS462CPT	B	49.3/122.0
IC2601	1130006221	S.IC TC4W53FU(TE12LF)	B	63.2/124.0
IC2602	1110003091	IC LA4425A-E		
Q101	1530003091	S.TRA 2SC4213-B(TE85RF)	T	11.2/17.5
Q102	1590003940	S.TRA RN1105(TE85LF)	T	20.7/5.6
Q103	1590004030	S.TRA KRX204U-RTK/P	T	38.4/20.2
Q201	1590003940	S.TRA RN1105(TE85LF)	T	16.2/31.2
Q202	1590002310	S.TRA DTC114EE TL	T	23.6/28.5
Q204	1590003940	S.TRA RN1105(TE85LF)	B	44.8/38.7
Q205	1590003940	S.TRA RN1105(TE85LF)	T	43.0/61.5
Q206	1590003940	S.TRA RN1105(TE85LF)	B	24.6/55.0
Q207	1590003940	S.TRA RN1105(TE85LF)	B	24.6/51.9
Q208	1590003940	S.TRA RN1105(TE85LF)	B	24.2/48.8
Q209	1590003940	S.TRA RN1105(TE85LF)	B	23.6/45.7
Q210	1590003940	S.TRA RN1105(TE85LF)	B	43.0/41.5
Q211	1530003852	S.TRA 2SC551A-F-TD-E	T	27.6/30.2
Q301	1530003852	S.TRA 2SC551A-F-TD-E	T	56.7/32.5
Q402	1590004030	S.TRA KRX204U-RTK/P	T	82.9/22.8
Q403	1590004030	S.TRA KRX204U-RTK/P	T	69.7/23.6
Q502	1530003852	S.TRA 2SC551A-F-TD-E	T	83.1/37.1
Q701	1580000780	S.FET 3SK195(TE85LF)	T	62.1/56.6
Q702	1580000780	S.FET 3SK195(TE85LF)	T	54.7/51.9
Q901	1580000780	S.FET 3SK195(TE85LF)	T	36.6/65.7
Q902	1580000780	S.FET 3SK195(TE85LF)	T	35.9/73.2
Q1001	1580000780	S.FET 3SK195(TE85LF)	T	18.0/76.0
Q1201	1590004030	S.TRA KRX204U-RTK/P	T	28.1/78.7
Q1401	1530004140	S.TRA L2SC4081RT1G <SLVJ>	B	42.5/74.3
Q1402	1530004140	S.TRA L2SC4081RT1G <SLVJ>	B	36.7/80.1
Q1501	1590004030	S.TRA KRX204U-RTK/P	T	30.6/78.5
Q1521	1530004140	S.TRA L2SC4081RT1G <SLVJ>	B	86.0/47.6
Q1601	1530003091	S.TRA 2SC4213-B(TE85RF)	T	8.3/53.0
Q1602	1590001870	S.TRA DTA114EE TL	T	4.6/53.0
Q1603	1590003940	S.TRA RN1105(TE85LF)	T	2.8/40.8
Q1604	1510000771	S.TRA 2SA1586-GR(TE85LF)	T	5.1/32.7
Q1606	1560001260	S.FET 2SK3018 T106	T	12.6/36.9
Q1701	1530004210	S.TRA DSC7004SOL	B	52.4/48.3
Q1702	1590003940	S.TRA RN1105(TE85LF)	B	54.4/52.2
Q1703	1530004210	S.TRA DSC7004SOL	B	52.4/67.4
Q1704	1590003940	S.TRA RN1105(TE85LF)	B	54.1/72.9
Q1901	1590004030	S.TRA KRX204U-RTK/P	T	35.8/78.5
Q1902	1590004030	S.TRA KRX204U-RTK/P	T	33.3/78.5
Q1903	1590004030	S.TRA KRX204U-RTK/P	B	23.7/17.0
Q1904	1590004030	S.TRA KRX204U-RTK/P	B	33.0/88.0
Q1905	1590004030	S.TRA KRX204U-RTK/P	B	46.0/41.0
Q1906	1590004030	S.TRA KRX204U-RTK/P	B	26.3/30.9
Q1907	1590004030	S.TRA KRX204U-RTK/P	T	41.0/78.5
Q1908	1590004030	S.TRA KRX204U-RTK/P	T	38.4/78.5
Q1909	1590004030	S.TRA KRX204U-RTK/P	B	22.1/11.9
Q1960	1550000090	S.FET RSQ035P03TR	B	38.0/103.7
Q2150	1590004030	S.TRA KRX204U-RTK/P	T	48.5/100.1
Q2151	1520000460	S.TRA 2SB1132 T100 R	T	55.4/103.8
Q2152	1520000460	S.TRA 2SB1132 T100 R	T	21.4/111.1
Q2153	1520000460	S.TRA 2SB1132 T100 R	T	49.8/104.6
Q2154	1590004030	S.TRA KRX204U-RTK/P	T	44.7/100.1
Q2155	1590004030	S.TRA KRX204U-RTK/P	T	40.0/100.1
Q2156	1590003940	S.TRA RN1105(TE85LF)	T	58.9/104.5
Q2157	1590003940	S.TRA RN1105(TE85LF)	T	25.5/107.5

Eqv.= This component is equivalent to the REF No. component listed above, and may be substituted on parts orders and repairs.

[MAIN UNIT]

REF NO.	PARTS NO.	DESCRIPTION	M.	H/V LOCATION
Q2158	1590003940	S.TRA RN1105(TE85LF)	T	45.6/107.1
Q2159	1590004030	S.TRA KRX204U-RTK/P	T	6.7/118.2
Q2160	1590004030	S.TRA KRX204U-RTK/P	T	7.7/122.2
Q2231	1590003940	S.TRA RN1105(TE85LF)	T	4.7/121.7
Q2232	1590004030	S.TRA KRX204U-RTK/P	T	57.4/114.8
Q2233	1590004030	S.TRA KRX204U-RTK/P	T	54.7/115.8
Q2301	1530004140	S.TRA L2SC4081RT1G <SLVJ>	T	30.6/109.1
Q2401	1530004210	S.TRA DSC7004SOL	B	80.2/26.4
Q2601	1560001260	S.FET 2SK3018 T106	B	36.2/124.7
Q2602	1550000360	S.FET RQ1E050RPTTR	B	37.4/127.6
Q2603	1530004140	S.TRA L2SC4081RT1G <SLVJ>	T	65.4/111.4
Q2605	1590003940	S.TRA RN1105(TE85LF)	T	11.7/112.7
Q2606	1540000451	S.TRA 2SD1623T-TD-E	B	89.5/120.0
Q2607	1590003940	S.TRA RN1105(TE85LF)	B	65.5/120.5
Q2608	1590003940	S.TRA RN1105(TE85LF)	B	45.0/128.7
D1	1750000581	S.DIO 1SV307(TPH3F)	T	70.2/16.6
D2	1750000581	S.DIO 1SV307(TPH3F)	T	70.4/14.9
D3	1750000581	S.DIO 1SV307(TPH3F)	T	45.3/19.8
D4	1750000581	S.DIO 1SV307(TPH3F)	T	41.9/19.1
D5	1750000581	S.DIO 1SV307(TPH3F)	T	70.4/18.4
D6	1790000620	S.DIO MA77(TX)	B	79.9/17.1
D7	1790000620	S.DIO MA77(TX)	T	78.1/15.9
D8	1790000620	S.DIO MA77(TX)	B	81.6/10.6
D9	1790000620	S.DIO MA77(TX)	T	79.1/11.5
D10	1750000581	S.DIO 1SV307(TPH3F)	T	42.5/20.9
D101	1750000581	S.DIO 1SV307(TPH3F)	T	13.3/22.5
D102	1750000581	S.DIO 1SV307(TPH3F)	T	15.7/19.2
D103	1750000581	S.DIO 1SV307(TPH3F)	T	20.4/8.8
D104	1750000581	S.DIO 1SV307(TPH3F)	T	34.8/18.0
D105	1750000581	S.DIO 1SV307(TPH3F)	T	23.2/12.7
D106	1750000581	S.DIO 1SV307(TPH3F)	T	29.7/21.0
D107	1750000581	S.DIO 1SV307(TPH3F)	T	44.0/23.7
D108	1750000951	S.DIO MA2J7320GL	B	27.2/18.3
D109	1750000951	S.DIO MA2J7320GL	B	24.8/20.3
D110	1790001241	S.DIO MA2S7280GL	B	51.6/26.5
D111	1790001241	S.DIO MA2S7280GL	B	51.6/24.7
D112	1750000581	S.DIO 1SV307(TPH3F)	T	15.7/21.0
D113	1750000581	S.DIO 1SV307(TPH3F)	T	10.3/19.8
D114	1790001251	S.DIO MA2S1110GL	T	35.7/21.4
D203	1750000581	S.DIO 1SV307(TPH3F)	T	19.4/35.7
D204	1750000581	S.DIO 1SV307(TPH3F)	T	25.7/58.3
D205	1750000581	S.DIO 1SV307(TPH3F)	T	25.7/56.3
D208	1750000581	S.DIO 1SV307(TPH3F)	T	25.7/53.4
D209	1750000581	S.DIO 1SV307(TPH3F)	T	25.7/50.6
D210	1750000581	S.DIO 1SV307(TPH3F)	T	25.7/47.7
D211	1750000581	S.DIO 1SV307(TPH3F)	T	25.7/44.8
D212	1750000581	S.DIO 1SV307(TPH3F)	T	25.7/39.2
D213	1750000581	S.DIO 1SV307(TPH3F)	T	25.7/41.5
D214	1750000581	S.DIO 1SV307(TPH3F)	T	47.7/59.3
D215	1750000581	S.DIO 1SV307(TPH3F)	T	47.7/56.3
D216	1750000581	S.DIO 1SV307(TPH3F)	T	48.0/53.7
D217	1750000581	S.DIO 1SV307(TPH3F)	T	47.8/49.7
D218	1750000581	S.DIO 1SV307(TPH3F)	B	41.8/47.3
D219	1750000581	S.DIO 1SV307(TPH3F)	B	38.9/41.7
D220	1750000581	S.DIO 1SV307(TPH3F)	B	44.7/28.6
D221	1750000581	S.DIO 1SV307(TPH3F)	B	40.5/36.1
D301	1750000581	S.DIO 1SV307(TPH3F)	T	47.3/28.5
D302	1750000581	S.DIO 1SV307(TPH3F)	T	49.3/30.3
D303	1750000581	S.DIO 1SV307(TPH3F)	T	64.1/30.0
D304	1750000581	S.DIO 1SV307(TPH3F)	T	62.4/35.2
D305	1750000581	S.DIO 1SV307(TPH3F)	T	73.4/35.2
D306	1750000581	S.DIO 1SV307(TPH3F)	T	64.5/25.7
D401	1790001241	S.DIO MA2S7280GL	T	86.7/24.9
D501	1750000531	S.DIO 1SV271(TPH3F)	T	90.6/32.3
D502	1750000531	S.DIO 1SV307(TPH3F)	T	86.2/31.5
D503	1750000581	S.DIO 1SV307(TPH3F)	T	89.4/29.8
D504	1750000531	S.DIO 1SV271(TPH3F)	T	89.8/37.8
D505	1750000581	S.DIO 1SV307(TPH3F)	T	86.7/40.1
D506	1750000581	S.DIO 1SV307(TPH3F)	B	87.3/35.6
D601	1750000581	S.DIO 1SV307(TPH3F)	B	90.0/38.6
D602	1750000581	S.DIO 1SV307(TPH3F)	T	92.5/41.5
D603	1750000581	S.DIO 1SV307(TPH3F)	B	76.2/46.6
D604	1750000581	S.DIO 1SV307(TPH3F)	T	66.7/43.7
D701	1750000581	S.DIO 1SV307(TPH3F)	T	61.2/43.8
D702	1750000581	S.DIO 1SV307(TPH3F)	T	65.1/41.4
D703	1750000581	S.DIO 1SV307(TPH3F)	T	62.7/61.5
D704	1750000581	S.DIO 1SV307(TPH3F)	T	62.7/63.2
D801	1750000431	S.DIO HSB88WSTR-E	T	74.1/60.3
D802	1750000581	S.DIO 1SV307(TPH3F)	T	63.1/73.4
D803	1750000581	S.DIO 1SV307(TPH3F)	T	65.5/64.6
D903	1750000581	S.DIO 1SV307(TPH3F)	T	39.5/69.4
D904	1750000581	S.DIO 1SV307(TPH3F)	T	39.5/72.8
D1301	1750000581	S.DIO 1SV307(TPH3F)	T	12.8/72.6
D1302	1750000581	S.DIO 1SV307(TPH3F)	T	13.9/70.9
D1521	1750000531	S.DIO 1SV271(TPH3F)	B	79.5/40.7
D1522	1750000531	S.DIO 1SV271(TPH3F)	B	79.5/42.5
D1601	1790001241	S.DIO MA2S7280GL	T	15.2/48.8
D1602	1790001241	S.DIO MA2S7280GL	T	18.3/53.2
D1604	1790001251	S.DIO MA2S1110GL	T	7.7/31.3
D1605	1790001251	S.DIO MA2S1110GL	T	7.7/32.8
D1606	1790001251	S.DIO MA2S1110GL	T	14.2/44.9
D1607	1			

[MAIN UNIT]

REF NO.	PARTS NO.	DESCRIPTION	M.	H/V LOCATION
D1702	1790001670	S.DIO RB706F-40T106	B	51.9/71.8
D1951	1750001110	S.DIO SM240A-T <SEI>	B	36.3/100.0
D2151	1790001251	S.DIO MA2S1110GL [USA]	T	39.0/87.1
	1790001251	S.DIO MA2S1110GL [KOR]		
	1790001251	S.DIO MA2S1110GL [AUS]		
D2153	1790001251	S.DIO MA2S1110GL [USA]	T	36.5/87.1
	1790001251	S.DIO MA2S1110GL [KOR]		
D2154	1790001251	S.DIO MA2S1110GL	T	36.5/88.4
D2155	1790001251	S.DIO MA2S1110GL	T	36.6/89.7
D2156	1790001251	S.DIO MA2S1110GL	T	39.0/90.6
D2157	1790001251	S.DIO MA2S1110GL [EUR]	T	48.6/87.1
	1790001251	S.DIO MA2S1110GL [ESP]		
	1790001251	S.DIO MA2S1110GL [USA]		
	1790001251	S.DIO MA2S1110GL [ITR]		
	1790001251	S.DIO MA2S1110GL [UK]		
	1790001251	S.DIO MA2S1110GL [KOR]		
	1790001251	S.DIO MA2S1110GL [AUS]		
	1790001251	S.DIO MA2S1110GL [CHN]		
D2158	1790001251	S.DIO MA2S1110GL	T	48.6/88.4
D2159	1790001251	S.DIO MA2S1110GL	T	48.6/89.7
D2160	1790001251	S.DIO MA2S1110GL	T	48.6/91.0
D2162	1790001251	S.DIO MA2S1110GL [USA] only	T	46.1/88.4
D2163	1790001251	S.DIO MA2S1110GL [EUR]	T	46.1/89.7
	1790001251	S.DIO MA2S1110GL [FRA]		
	1790001251	S.DIO MA2S1110GL [ESP]		
	1790001251	S.DIO MA2S1110GL [ITR]		
	1790001251	S.DIO MA2S1110GL [UK]		
D2166	1790001251	S.DIO MA2S1110GL [ESP]	T	29.4/88.3
	1790001251	S.DIO MA2S1110GL [KOR]		
D2168	1790001251	S.DIO MA2S1110GL [EUR]	T	29.4/90.7
	1790001251	S.DIO MA2S1110GL [ESP]		
	1790001251	S.DIO MA2S1110GL [ITR]		
	1790001251	S.DIO MA2S1110GL [UK]		
	1790001251	S.DIO MA2S1110GL [AUS]		
D2169	1790001251	S.DIO MA2S1110GL [EUR]	T	26.9/87.1
	1790001251	S.DIO MA2S1110GL [ESP]		
	1790001251	S.DIO MA2S1110GL [USA]		
	1790001251	S.DIO MA2S1110GL [ITR]		
	1790001251	S.DIO MA2S1110GL [UK]		
	1790001251	S.DIO MA2S1110GL [KOR]		
	1790001251	S.DIO MA2S1110GL [CHN]		
D2170	1790001251	S.DIO MA2S1110GL [EUR]	T	26.9/88.4
	1790001251	S.DIO MA2S1110GL [USA]		
	1790001251	S.DIO MA2S1110GL [ITR]		
	1790001251	S.DIO MA2S1110GL [UK]		
	1790001251	S.DIO MA2S1110GL [AUS]		
	1790001251	S.DIO MA2S1110GL [CHN]		
D2171	1790001251	S.DIO MA2S1110GL [FRA]	T	26.9/89.7
	1790001251	S.DIO MA2S1110GL [ESP]		
	1790001251	S.DIO MA2S1110GL [UK]		
	1790001251	S.DIO MA2S1110GL [KOR]		
	1790001251	S.DIO MA2S1110GL [CHN]		
D2172	1790001251	S.DIO MA2S1110GL [EUR]	T	26.9/91.0
	1790001251	S.DIO MA2S1110GL [FRA]		
	1790001251	S.DIO MA2S1110GL [ESP]		
	1790001251	S.DIO MA2S1110GL [ITR]		
	1790001251	S.DIO MA2S1110GL [UK]		
	1790001251	S.DIO MA2S1110GL [KOR]		
	1790001251	S.DIO MA2S1110GL [AUS]		
D2173	1790001251	S.DIO MA2S1110GL	T	6.5/120.2
D2174	1790001251	S.DIO MA2S1110GL [EUR]	T	52.1/88.3
	1790001251	S.DIO MA2S1110GL [FRA]		
	1790001251	S.DIO MA2S1110GL [ESP]		
	1790001251	S.DIO MA2S1110GL [USA]		
	1790001251	S.DIO MA2S1110GL [UK]		
	1790001251	S.DIO MA2S1110GL [KOR]		
	1790001251	S.DIO MA2S1110GL [AUS]		
	1790001251	S.DIO MA2S1110GL [CHN]		
D2175	1790001251	S.DIO MA2S1110GL	T	52.1/87.1
D2201	1730002341	S.ZEN MAZ8047GML	T	10.5/122.8
D2205	1790001011	S.ZEN MAZ8043GLL	T	13.5/115.2
D2211	1790001011	S.ZEN MAZ8043GLL	T	21.5/118.0
D2231	1160000070	S.DIO DAN202K T146	T	57.7/117.9
D2232	1790001670	S.DIO RB706F-40T106	T	56.9/112.2
D2401	1160000070	S.DIO DAN202K T146	B	85.8/27.2
D2402	1790001251	S.DIO MA2S1110GL	T	63.6/113.3
D2551	1790001141	S.ZEN MAZ8039GLL	B	45.4/116.5
D2601	1160000070	S.DIO DAN202K T146	B	42.1/126.4
D2602	1790001251	S.DIO MA2S1110GL	B	41.3/128.5
FI2	2040001420	S.LC LFB32440MSC1-955 (LFSC25N12B0)	T	59.4/13.9
FI3	2040001420	S.LC LFB32440MSC1-955 (LFSC25N12B0)	T	53.4/13.5
FI601	2010002640	S.XTA DSF753SDF 124.487 MHz (FL-374)	T	81.0/43.8
FI901	2020002011	S.CER CFUKG455KF4A-R0	T	44.8/69.7
FI1001	2020002011	S.CER CFUKG455KF4A-R0	T	27.8/67.0
FI1401	2020001810	S.CER SFECV10M7FA00-R0 (SFECV10.7MA5S)	B	37.5/76.5
FI1402	2020001810	S.CER SFECV10M7FA00-R0 (SFECV10.7MA5S)	B	29.5/77.5
FI1501	2040002050	SAW K3561M [EUR]		
	2040002050	SAW K3561M [FRA]		
	2040002050	SAW K3561M [ESP]		
	2040002040	SAW M3565M [USA]		
	2040002050	SAW K3561M [ITR]		
	2040002050	SAW K3561M [UK]		
	2040002040	SAW M3565M [KOR]		
	2040002050	SAW K3561M [AUS]		
	2040002050	SAW K3561M [CHN]		

Eqv.= This component is equivalent to the REF No. component listed above, and may be substituted on parts orders and repairs.

[MAIN UNIT]

REF NO.	PARTS NO.	DESCRIPTION	M.	H/V LOCATION
FI1502	2020001720	S.CER SFSKA5M50CF00-R1 (SFSCC5.5MC2-T) [EUR]	B	69.4/57.8
	2020001720	S.CER SFSKA5M50CF00-R1 (SFSCC5.5MC2-T) [FRA]		
	2020001720	S.CER SFSKA5M50CF00-R1 (SFSCC5.5MC2-T) [ESP]		
	2020001700	S.CER SFSKA4M50CF00-R1 (SFSCC4.5MC2-T) [USA]		
	2020001720	S.CER SFSKA5M50CF00-R1 (SFSCC5.5MC2-T) [ITR]		
	2020001720	S.CER SFSKA5M50CF00-R1 (SFSCC5.5MC2-T) [UK]		
	2020001700	S.CER SFSKA4M50CF00-R1 (SFSCC4.5MC2-T) [KOR]		
	2020001720	S.CER SFSKA5M50CF00-R1 (SFSCC5.5MC2-T) [AUS]		
	2020001720	S.CER SFSKA5M50CF00-R1 (SFSCC5.5MC2-T) [CHN]		
FI1503	2020001730	S.CER TPSKA5M50B00-R1 (TPSCC5.5MB-TC1) [EUR]	B	73.6/78.7
	2020001730	S.CER TPSKA5M50B00-R1 (TPSCC5.5MB-TC1) [FRA]		
	2020001730	S.CER TPSKA5M50B00-R1 (TPSCC5.5MB-TC1) [ESP]		
	2020001710	S.CER TPSKA4M50B00-R1 (TPSCC4.5M0-TC1) [USA]		
	2020001730	S.CER TPSKA5M50B00-R1 (TPSCC5.5MB-TC1) [ITR]		
	2020001730	S.CER TPSKA5M50B00-R1 (TPSCC5.5MB-TC1) [UK]		
	2020001710	S.CER TPSKA4M50B00-R1 (TPSCC4.5M0-TC1) [KOR]		
	2020001730	S.CER TPSKA5M50B00-R1 (TPSCC5.5MB-TC1) [AUS]		
	2020001730	S.CER TPSKA5M50B00-R1 (TPSCC5.5MB-TC1) [CHN]		
L3	6200004480	S.COI MLF1608D R82K-T	T	76.5/10.2
L4	6200002041	S.COI NLV25T-101J	T	75.7/18.9
L5	6200004780	S.COI MLF1608A 1R5K-T	T	67.4/18.6
L8	6200010910	S.COI LQW18AN56NG00D	T	57.0/16.7
L10	6200010910	S.COI LQW18AN56NG00D	T	57.3/18.0
L11	6200011780	S.COI LQW18ANR18G00D	T	56.5/20.1
L12	6200011680	S.COI LQW18ANR12G00D	T	53.8/19.9
L13	6200011780	S.COI LQW18ANR18G00D	T	52.8/18.6
L14	6200009590	S.COI MLG1608B 18NJ-T	T	57.3/11.4
L16	6200005721	S.COI ELJRE 33NGFA	T	49.6/19.8
L18	6200005041	S.COI NLV25T-220J	T	73.4/9.6
L19	6200002041	S.COI NLV25T-101J	T	67.0/14.8
L21	6200006671	S.COI ELJRE 68NGFA	B	80.4/14.7
L22	6200002861	S.COI NLV25T-4R7J	B	79.8/20.3
L23	6200002861	S.COI NLV25T-4R7J	B	84.0/9.3
L24	6200011520	S.COI SLF7045T-102MR14-PF	B	8.9/69.0
L101	6200002041	S.COI NLV25T-101J	T	15.8/17.1
L102	6200002041	S.COI NLV25T-101J	T	20.4/10.9
L103	6200010800	S.COI C2520C-4R7G-A	T	24.4/7.4
L104	6200010800	S.COI C2520C-4R7G-A	T	27.9/10.0
L105	6200002041	S.COI NLV25T-101J	T	28.1/12.9
L106	6200002041	S.COI NLV25T-101J	B	17.6/16.4
L107	6200002041	S.COI NLV25T-101J	B	31.6/21.7
L108	6200002041	S.COI NLV25T-101J	T	25.3/20.9
L109	6200001831	S.COI NLV32T-100J	T	28.5/15.6
L110	6200003121	S.COI NLV32T-8R2J	T	21.1/15.1
L112	6200002041	S.COI NLV25T-101J	B	43.5/23.1
L113	6200002041	S.COI NLV25T-101J	T	7.2/17.6
L114	6200002041	S.COI NLV25T-101J	T	7.2/15.0
L116	6200003131	S.COI NLV32T-120J	T	28.5/18.6
L117	6200001831	S.COI NLV32T-100J	T	21.1/18.1
L204	6200002041	S.COI NLV25T-101J	T	18.8/33.0
L205	6200010740	S.COI C2520C-R27G-A	T	20.3/38.2
L207	6200010680	S.COI C2520C-R22G-A (0.22U)	T	21.8/41.3
L213	6200005011	S.COI NLV25T-100J	T	22.7/34.9
L215	6200010330	S.COI C2012C-R18G-A	B	27.8/38.6
L217	6200009990	S.COI C2012C-R22G-A	T	22.7/32.5
L218	6200005011	S.COI NLV25T-100J	B	25.7/43.4
L219	6200011050	S.COI C2012C-R12G-A	B	29.0/41.4
L220	6200010320	S.COI C2012C-R15G-A	B	34.1/37.9
L221	6200002041	S.COI NLV25T-101J	T	15.1/52.7
L222	6200002041	S.COI NLV25T-101J	T	45.6/61.5
L223	6200002041	S.COI NLV25T-101J	B	40.5/55.3
L224	6200002041	S.COI NLV25T-101J	B	27.5/55.8
L225	6200002041	S.COI NLV25T-101J	B	27.5/52.0
L226	6200002861	S.COI NLV25T-4R7J	T	40.3/57.6
L227	6200003711	S.COI NLV25T-2R7J	T	29.1/55.5
L228	6200002861	S.COI NLV25T-4R7J	T	44.6/54.7
L229	6200004671	S.COI NLV25T-3R9J	T	35.1/51.5
L230	6200002041	S.COI NLV25T-101J	B	40.5/52.3
L231	6200002041	S.COI NLV25T-101J	B	40.5/49.5
L232	6200002041	S.COI NLV25T-101J	B	27.1/49.1
L233	6200002041	S.COI NLV25T-101J	B	26.4/46.2
L234	6200010780	S.COI C2520C-1R0G-A	T	35.6/48.5
L235	6200010530	S.COI C2520C-R56G-A (0.56U)	B	33.0/49.5
L236	6200010950	S.COI C2520C-1R5G-A (1.5U)	T	43.4/50.4
L237	6200010450	S.COI C2520C-R82G-A (0.82U)	B	33.0/46.4
L238	6200002041	S.COI NLV25T-101J	B	44.0/45.1
L239	6200002041	S.COI NLV25T-101J	B	38.8/39.5
L240	6200002041	S.COI NLV25T-101J	T	29.5/42.1
L241	6200010870	S.COI C2520C-R33G-A (0.33U)	B	35.2/41.6
L242	6200005011	S.COI NLV25T-100J	T	33.5/29.9
L243	6140004601	S.COI LR-518A	T	28.4/35.2
L244	6200010960	S.COI C2520C-R47G-A (0.47U)	B	39.8/44.2
L245	6200005011	S.COI NLV25T-100J	B	41.3/28.3
L246				

[MAIN UNIT]

REF NO.	PARTS NO.	DESCRIPTION	M.	H/V LOCATION
L248	6200005011	S.COI NLV25T-100J	B	43.8/36.4
L301	6200002041	S.COI NLV25T-101J	T	36.1/27.4
L302	6200002041	S.COI NLV25T-101J	T	52.6/31.8
L303	6200002041	S.COI NLV25T-101J	T	52.3/35.4
L304	6140004591	S.COI LR-517A	T	56.4/39.0
L305	6200002041	S.COI NLV25T-101J	T	52.9/29.3
L306	6200002041	S.COI NLV25T-101J	T	61.8/39.4
L307	6200002041	S.COI NLV25T-101J	T	60.9/32.0
L308	6200002041	S.COI NLV25T-101J	T	65.0/33.1
L309	6200009070	S.COI LQW18AN18NG00D (LQW1608A18NG00)	T	49.3/24.0
L310	6200010650	S.COI C2520C-R12G-A (0.12U)	T	65.7/38.2
L311	6200009220	S.COI LQW18AN15NG00D (LQW1608A15NG00)	T	53.6/23.3
L312	6200010660	S.COI C2520C-R15G-A (0.15U)	T	69.6/34.3
L313	6200011730	S.COI LQW18AN10NG00D	T	61.6/25.7
L314	6200002041	S.COI NLV25T-101J	T	72.6/37.4
L315	6200002041	S.COI NLV25T-101J	T	75.9/31.9
L402	6140004610	S.COI LR-520	T	70.8/27.9
L403	6200002041	S.COI NLV25T-101J	T	81.1/19.8
L404	6130002961	S.COI #617DB-1327=P3	T	84.4/27.9
L406	6130002961	S.COI #617DB-1327=P3	T	77.7/24.2
L421	6200004590	S.COI MLF1608D R18K-T	T	86.4/21.7
L501	6200004660	S.COI MLF1608A 1R8K-T	T	93.4/35.8
L503	6200004660	S.COI MLF1608A 1R8K-T	T	83.3/31.2
L507	6200001981	S.COI NLV25T-1R0J	T	78.8/34.4
L508	6200010650	S.COI C2520C-R12G-A (0.12U)	T	86.4/34.4
L509	6200004660	S.COI MLF1608A 1R8K-T	T	93.2/38.8
L511	6200004150	S.COI MLF1608D 47NM-T	T	92.7/37.3
L512	6200009610	S.COI MLG1608B 39NJ-T	B	89.7/32.9
L601	6200004660	S.COI MLF1608A 1R8K-T	B	85.7/38.6
L603	6200004660	S.COI MLF1608A 1R8K-T	T	89.4/42.2
L604	6150005330	S.COI LS-548 PKI-4185	T	90.5/46.2
L605	6200004660	S.COI MLF1608A 1R8K-T	T	93.2/40.0
L607	6200011800	S.COI C2520C-47NG-A	B	85.5/43.6
L609	6200011800	S.COI C2520C-47NG-A	B	81.9/46.9
L610	6200004660	S.COI MLF1608A 1R8K-T	B	78.2/44.9
L611	6200004660	S.COI MLF1608A 1R8K-T	T	68.0/46.3
L612	6150005330	S.COI LS-548 PKI-4185	T	72.3/42.4
L701	6150005350	S.COI LS-550 PKI-4187	T	62.9/48.6
L702	6150005340	S.COI LS-549 PKI-4186	T	54.8/45.5
L703	6150005350	S.COI LS-550 PKI-4187	T	55.3/59.5
L704	6200004940	S.COI MLF1608D R27K-T	T	62.3/59.7
L705	6200009920	S.COI C2012C-R10G-A	T	61.8/41.7
L801	6140002810	S.COI LR-317	T	68.6/61.3
L802	6200005190	S.COI MLF1608D R56K-T	T	89.1/58.5
L803	6140002810	S.COI LR-317	T	79.6/60.2
L804	6200005011	S.COI NLV25T-100J	T	57.5/69.1
L805	6200009871	S.COI NLV25T-120J	T	57.6/71.9
L806	6200004741	S.COI NLV25T-1R2J	T	63.1/71.2
L807	6200004741	S.COI NLV25T-1R2J	T	63.2/66.7
L808	6200004100	S.COI MLF1608D 68NM-T	T	86.2/61.7
L901	6200003520	S.COI ELJFB 102K-F	B	37.6/72.5
L904	6150005360	S.COI LS-551 PKI-4188-1	T	51.7/70.9
L905	6200003520	S.COI ELJFB 102K-F	B	40.2/59.9
L906	6200003520	S.COI ELJFB 102K-F	B	33.7/62.5
L908	6200003520	S.COI ELJFB 102K-F	B	31.5/69.8
L1003	6200003520	S.COI ELJFB 102K-F	B	13.0/75.3
L1102	6200002041	S.COI NLV25T-101J	T	7.1/89.7
L1301	6200002041	S.COI NLV25T-101J	T	8.3/55.8
L1302	6200002041	S.COI NLV25T-101J	T	11.8/58.6
L1303	6200002041	S.COI NLV25T-101J	T	4.8/55.8
L1401	6200002041	S.COI NLV25T-101J	B	43.4/79.7
L1402	6200004790	S.COI MLF1608D R47K-T	B	44.1/70.4
L1403	6200002041	S.COI NLV25T-101J	B	17.7/85.0
L1404	6200003711	S.COI NLV25T-2R7J	B	18.3/80.4
L1405	6200002041	S.COI NLV25T-101J	B	17.7/85.0
L1491	6200010870	S.COI C2520C-R33G-A (0.33U) [EUR]	B	85.0/30.7
	6200010870	S.COI C2520C-R33G-A (0.33U) [FRA]		
	6200010870	S.COI C2520C-R33G-A (0.33U) [ESP]		
	6200010740	S.COI C2520C-R27G-A [USA]		
	6200010870	S.COI C2520C-R33G-A (0.33U) [ITR]		
	6200010870	S.COI C2520C-R33G-A (0.33U) [UK]		
	6200010740	S.COI C2520C-R27G-A [KOR]		
	6200010870	S.COI C2520C-R33G-A (0.33U) [AUS]		
	6200010870	S.COI C2520C-R33G-A (0.33U) [CHN]		
L1492	6200010870	S.COI C2520C-R33G-A (0.33U) [EUR]	B	80.6/33.1
	6200010870	S.COI C2520C-R33G-A (0.33U) [FRA]		
	6200010870	S.COI C2520C-R33G-A (0.33U) [ESP]		
	6200010740	S.COI C2520C-R27G-A [USA]		
	6200010870	S.COI C2520C-R33G-A (0.33U) [ITR]		
	6200010870	S.COI C2520C-R33G-A (0.33U) [UK]		
	6200010740	S.COI C2520C-R27G-A [KOR]		
	6200010870	S.COI C2520C-R33G-A (0.33U) [AUS]		
	6200010870	S.COI C2520C-R33G-A (0.33U) [CHN]		
L1501	6200005011	S.COI NLV25T-100J	B	91.2/27.1
L1502	6200012170	S.COI MLG1608S R18J-T	B	79.5/38.3
L1503	6200012170	S.COI MLG1608S R18J-T	B	82.1/37.5
L1504	6200005011	S.COI NLV25T-100J	B	75.7/43.4
L1505	6200005190	S.COI MLF1608D R56K-T	T	80.7/51.7
L1506	6150005080	S.COI LS-535 (4KMH) [EUR]	T	68.7/55.4
	6150005080	S.COI LS-535 (4KMH) [FRA]		
	6150005080	S.COI LS-535 (4KMH) [ESP]		
	6150005070	S.COI LS-534 (4KMH) [USA]		
	6150005080	S.COI LS-535 (4KMH) [ITR]		
	6150005080	S.COI LS-535 (4KMH) [UK]		
	6150005070	S.COI LS-534 (4KMH) [KOR]		
	6150005080	S.COI LS-535 (4KMH) [AUS]		
	6150005080	S.COI LS-535 (4KMH) [CHN]		
L1507	6200005031	S.COI NLV25T-180J	B	71.7/62.2
L1508	6200005021	S.COI NLV25T-150J	B	77.4/79.6
L1951	6180003750	S.COI 7E10Y-101M-R-0231	B	34.6/110.9
L1952	6180003750	S.COI 7E10Y-101M-R-0231	B	54.7/113.4
L1953	6180003750	S.COI 7E10Y-101M-R-0231	B	14.0/111.9
L1954	6180003750	S.COI 7E10Y-101M-R-0231	B	24.5/119.8

Eqv.= This component is equivalent to the REF No. component listed above, and may be substituted on parts orders and repairs.

[MAIN UNIT]

REF NO.	PARTS NO.	DESCRIPTION	M.	H/V LOCATION
L2001	6200005011	S.COI NLV25T-100J	B	72.5/16.4
L2002	6200002041	S.COI NLV25T-101J	B	84.6/3.8
L2003	6200002041	S.COI NLV25T-101J	B	81.1/4.3
L2004	6200002041	S.COI NLV25T-101J	B	76.4/20.4
L2006	6200002041	S.COI NLV25T-101J	B	64.2/12.9
L2007	6200002041	S.COI NLV25T-101J	B	70.9/3.9
L2008	6200002041	S.COI NLV25T-101J	B	68.0/6.2
L2009	6200005011	S.COI NLV25T-100J	B	70.9/10.6
L2010	6200002041	S.COI NLV25T-101J	B	60.8/13.7
L2011	6200011300	S.COI EXCML16A270U	T	86.6/9.2
L2012	6200011300	S.COI EXCML16A270U	B	84.8/22.0
L2013	6200002041	S.COI NLV25T-101J	B	71.9/19.4
L2015	6200002041	S.COI NLV25T-101J	B	52.5/10.4
L2016	6200002041	S.COI NLV25T-101J	B	59.2/11.2
L2017	6200002041	S.COI NLV25T-101J	B	57.1/14.1
L2018	6200002041	S.COI NLV25T-101J	B	19.7/129.5
L2019	6200002041	S.COI NLV25T-101J	T	22.3/126.9
L2020	6200002041	S.COI NLV25T-101J	B	28.0/131.4
L2021	6200005011	S.COI NLV25T-100J	B	27.9/126.5
L2022	6200002041	S.COI NLV25T-101J	B	22.6/127.6
L2023	6200002041	S.COI NLV25T-101J	B	23.3/131.4
L2024	6200002041	S.COI NLV25T-101J	T	12.8/128.2
L2025	6200002041	S.COI NLV25T-101J	B	87.5/6.3
L2026	6200002041	S.COI NLV25T-101J	B	77.7/5.0
L2027	6200002041	S.COI NLV25T-101J	B	76.6/12.3
L2028	6200002041	S.COI NLV25T-101J	B	67.5/10.8
L2029	6200002041	S.COI NLV25T-101J	B	64.1/10.4
L2030	6200002041	S.COI NLV25T-101J	B	67.5/3.7
L2031	6200002041	S.COI NLV25T-101J	B	76.5/14.8
L2032	6200002041	S.COI NLV25T-101J	B	66.2/15.4
L2033	6200011300	S.COI EXCML16A270U	B	69.6/14.6
L2034	6200009300	S.COI ELJPA 100KF 10U	B	67.9/19.4
L2035	6200002041	S.COI NLV25T-101J	B	59.8/18.5
L2036	6200002041	S.COI NLV25T-101J	B	64.1/3.8
L2037	6200002041	S.COI NLV25T-101J	B	88.4/3.8
L2041	6180003750	S.COI 7E10Y-101M-R-0231	B	62.6/86.9
L2042	6200002861	S.COI NLV25T-4R7J	B	62.9/79.3
L2053	6200002041	S.COI NLV25T-101J	B	28.7/91.0
L2151	6200002041	S.COI NLV25T-101J	B	36.9/121.1
L2152	6200002041	S.COI NLV25T-101J	B	52.3/14.7
L2201	6200005011	S.COI NLV25T-100J	T	27.4/125.9
L2202	6200005011	S.COI NLV25T-100J	T	17.1/124.3
L2231	6200002041	S.COI NLV25T-101J	T	34.0/104.3
L2256	6200002041	S.COI NLV25T-101J	T	15.0/103.5
L2257	6200002041	S.COI NLV25T-101J	T	10.5/89.7
L2260	6200002041	S.COI NLV25T-101J	T	68.6/110.9
L2263	6200002041	S.COI NLV25T-101J	T	62.3/99.4
L2264	6200002041	S.COI NLV25T-101J	T	62.3/96.9
L2265	6200002041	S.COI NLV25T-101J	T	62.5/94.4
L2266	6200002041	S.COI NLV25T-101J	T	62.5/91.6
L2267	6200002041	S.COI NLV25T-101J	T	66.1/89.7
L2268	6200002041	S.COI NLV25T-101J	T	62.5/87.2
L2272	6200002041	S.COI NLV25T-101J	T	71.1/90.2
L2402	6200002041	S.COI NLV25T-101J	B	89.4/98.0
L2403	6200002041	S.COI NLV25T-101J	B	89.2/84.0
L2404	6200002041	S.COI NLV25T-101J	T	81.6/96.8
L2405	6200002041	S.COI NLV25T-101J	B	89.3/95.5
L2406	6200002041	S.COI NLV25T-101J	T	84.8/93.8
L2408	6200011300	S.COI EXCML16A270U	T	82.2/92.3
L2409	6200002041	S.COI NLV25T-101J	B	89.3/88.5
L2411	6200011300	S.COI EXCML16A270U	T	85.1/89.7
L2601	6200009330	S.COI SLF12555T-681MR43-PF	T	87.6/119.7
L2605	6200009330	S.COI SLF12555T-681MR43-PF	T	71.1/119.7
R1	70300011400	S.RES ERJ2GEJ 5R6 X (5.6)	T	79.7/17.0
R2	7030009270	S.RES ERJ2GEJ 821 X (820)	T	81.3/17.0
R3	7030009270	S.RES ERJ2GEJ 821 X (820)	T	79.7/17.0
R5	7030010090	S.RES ERJ2GEJ 180 X (18)	T	74.2/16.9
R6	7030008280	S.RES ERJ2GEJ 271 X (270)	T	74.8/15.8
R7	7030008280	S.RES ERJ2GEJ 271 X (270)	T	73.2/15.8
R8	7030009200	S.RES ERJ2GEJ 390 X (39)	T	73.1/18.5
R9	7030003400	S.RES ERJ3GEJ 471 V (470)	T	69.9/13.3
R10	7030005120	S.RES ERJ2GEJ 102 X (1K)	T	72.8/14.9
R11	7030005300	S.RES ERJ2GEJ 150 X (15)	T	62.1/16.0
R12	7030010040	S.RES ERJ2GEJ-JPW	T	62.9/13.9
R13	7030005090	S.RES ERJ2GEJ 104 X (100K)	T	66.8/20.6
R15	7030005090	S.RES ERJ2GEJ 104 X (100K)	T	70.4/10.5
R16	7030003860	S.RES ERJ3GE JPW V	T	62.5/12.4
R17	7030005090	S.RES ERJ2GEJ 104 X (100K)	T	76.4/15.8
R18	7030007270	S.RES ERJ2GEJ 151 X (150)	T	44.3/17.3
R19	7030003860	S.RES ERJ3GE JPW V	T	50.4/14.6
R20	7030009530	S.RES ERJ2GEJ 270 X (27)	T	69.5/19.8
R21	7030009530	S.RES ERJ2GEJ 270 X (27)	T	65.5/22.8
R22	7030010040	S.RES ERJ2GEJ-JPW	T	78.1/13.8
R23	7030007290	S.RES ERJ2GEJ 222 X (2.2K)</		

[MAIN UNIT]

REF NO.	PARTS NO.	DESCRIPTION	M.	H/V LOCATION
R105	7030005580	S.RES ERJ2GEJ 560 X (56)	T	15.8/22.4
R106	7030005000	S.RES ERJ2GEJ 471 X (470)	T	13.2/20.5
R107	7030005000	S.RES ERJ2GEJ 471 X (470)	T	10.9/22.1
R108	7030005000	S.RES ERJ2GEJ 471 X (470)	T	10.9/23.0
R111	7030005000	S.RES ERJ2GEJ 471 X (470)	T	10.9/21.2
R112	7030005090	S.RES ERJ2GEJ 104 X (100K)	T	25.6/12.6
R113	7030005090	S.RES ERJ2GEJ 104 X (100K)	T	26.9/5.7
R114	7030009280	S.RES ERJ2GEJ 391 X	B	33.2/23.4
R115	7030009280	S.RES ERJ2GEJ 391 X	B	34.1/22.3
R116	7030009280	S.RES ERJ2GEJ 391 X	T	22.3/21.3
R117	7030009280	S.RES ERJ2GEJ 391 X	T	20.7/21.3
R118	7030009280	S.RES ERJ2GEJ 391 X	B	41.0/23.3
R119	7030009280	S.RES ERJ2GEJ 391 X	B	41.0/22.4
R120	7030005090	S.RES ERJ2GEJ 104 X (100K)	B	50.4/23.6
R121	7030005090	S.RES ERJ2GEJ 104 X (100K)	T	44.1/22.3
R122	7030009280	S.RES ERJ2GEJ 391 X	T	7.8/20.3
R123	7030009280	S.RES ERJ2GEJ 391 X	T	7.8/19.4
R125	7030009280	S.RES ERJ2GEJ 391 X	T	35.6/20.3
R126	7030009280	S.RES ERJ2GEJ 391 X	T	27.1/4.8
R127	7030009280	S.RES ERJ2GEJ 391 X	T	25.5/4.8
R128	7030009280	S.RES ERJ2GEJ 391 X	T	35.6/19.4
R202	7030005090	S.RES ERJ2GEJ 104 X (100K)	T	18.1/31.2
R203	7030005090	S.RES ERJ2GEJ 104 X (100K)	T	42.9/60.0
R204	7030005090	S.RES ERJ2GEJ 104 X (100K)	B	43.0/54.4
R205	7030009280	S.RES ERJ2GEJ 391 X	T	19.4/54.2
R206	7030005090	S.RES ERJ2GEJ 104 X (100K)	B	43.0/51.5
R207	7030005090	S.RES ERJ2GEJ 104 X (100K)	B	43.0/50.6
R208	7030005090	S.RES ERJ2GEJ 104 X (100K)	B	46.5/45.1
R216	7030005090	S.RES ERJ2GEJ 104 X (100K)	B	44.3/43.3
R217	7030005050	S.RES ERJ2GEJ 103 X (10K)	T	18.1/30.3
R218	7030004970	S.RES ERJ2GEJ 470 X (47)	T	21.9/30.0
R225	7030005050	S.RES ERJ2GEJ 103 X (10K)	T	19.1/29.1
R226	7030009280	S.RES ERJ2GEJ 391 X	T	17.6/54.2
R227	7030005120	S.RES ERJ2GEJ 102 X (1K)	T	30.9/31.0
R228	7030009140	S.RES ERJ2GEJ 272 X (2.7K)	T	30.9/29.2
R301	7030009280	S.RES ERJ2GEJ 391 X	T	44.5/28.8
R302	7030009280	S.RES ERJ2GEJ 391 X	T	38.6/27.9
R303	7030004970	S.RES ERJ2GEJ 470 X (47)	T	52.5/38.9
R304	7030004980	S.RES ERJ2GEJ 101 X (100)	T	55.1/35.6
R305	7030005120	S.RES ERJ2GEJ 102 X (1K)	T	60.0/33.8
R306	7030008280	S.RES ERJ2GEJ 271 X (270)	T	55.4/28.8
R307	7030004980	S.RES ERJ2GEJ 101 X (100)	T	56.8/35.6
R308	7030007290	S.RES ERJ2GEJ 222 X (2.2K)	T	59.2/30.1
R309	7030008280	S.RES ERJ2GEJ 271 X (270)	T	58.6/29.2
R310	7030005090	S.RES ERJ2GEJ 104 X (100K)	T	50.1/31.7
R311	7030009280	S.RES ERJ2GEJ 391 X	T	65.4/31.4
R312	7030009280	S.RES ERJ2GEJ 391 X	T	63.8/31.4
R314	7030009280	S.RES ERJ2GEJ 391 X	T	73.4/32.5
R315	7030009280	S.RES ERJ2GEJ 391 X	T	74.9/33.8
R401	7030010040	S.RES ERJ2GEJ-JPW	T	75.0/29.6
R402	7030010040	S.RES ERJ2GEJ-JPW	T	75.0/27.8
R403	7030004980	S.RES ERJ2GEJ 101 X (100)	T	76.7/29.7
R404	7030010040	S.RES ERJ2GEJ-JPW	T	72.0/23.2
R405	7030004980	S.RES ERJ2GEJ 101 X (100)	T	86.8/23.9
R406	7030005580	S.RES ERJ2GEJ 560 X (56)	T	73.1/30.6
R407	7030005580	S.RES ERJ2GEJ 560 X (56)	T	72.0/25.0
R408	7030010040	S.RES ERJ2GEJ-JPW	T	83.4/19.3
R411	7030007260	S.RES ERJ2GEJ 330 X (33)	T	80.1/29.5
R412	7030007260	S.RES ERJ2GEJ 330 X (33)	T	80.1/26.8
R414	7030004980	S.RES ERJ2GEJ 101 X (100)	T	78.3/29.7
R416	7030010090	S.RES ERJ2GEJ 180 X (18)	T	88.4/24.5
R417	7030008280	S.RES ERJ2GEJ 271 X (270)	T	89.3/25.3
R418	7030008280	S.RES ERJ2GEJ 271 X (270)	T	88.0/22.9
R421	7030010090	S.RES ERJ2GEJ 180 X (18)	B	88.6/20.2
R422	7030008280	S.RES ERJ2GEJ 271 X (270)	B	90.2/20.2
R423	7030008280	S.RES ERJ2GEJ 271 X (270)	B	90.2/19.3
R424	7030005530	S.RES ERJ2GEJ 100 X (10)	T	88.5/21.6
R501	7030005120	S.RES ERJ2GEJ 102 X (1K)	T	91.3/35.6
R502	7030005120	S.RES ERJ2GEJ 102 X (1K)	T	92.9/34.4
R509	7030005580	S.RES ERJ2GEJ 560 X (56)	T	83.5/33.1
R510	7030010040	S.RES ERJ2GEJ-JPW	T	83.5/34.1
R512	7030004980	S.RES ERJ2GEJ 101 X (100)	T	81.8/34.1
R517	7030010040	S.RES ERJ2GEJ-JPW	T	80.0/31.0
R518	7030007290	S.RES ERJ2GEJ 222 X (2.2K)	T	79.6/37.1
R519	7030007290	S.RES ERJ2GEJ 222 X (2.2K)	T	79.6/38.9
R520	7030005120	S.RES ERJ2GEJ 102 X (1K)	T	89.2/39.2
R521	7030005000	S.RES ERJ2GEJ 471 X (470)	T	84.3/40.4
R523	7030005120	S.RES ERJ2GEJ 102 X (1K)	T	91.3/34.7
R524	7030005120	S.RES ERJ2GEJ 102 X (1K)	B	86.9/30.2
R601	7030005000	S.RES ERJ2GEJ 471 X (470)	B	88.6/40.0
R602	7030005000	S.RES ERJ2GEJ 471 X (470)	T	91.1/39.6
R603	7030005000	S.RES ERJ2GEJ 471 X (470)	T	89.2/41.0
R604	7030005000	S.RES ERJ2GEJ 471 X (470)	B	78.7/45.9
R605	7030010040	S.RES ERJ2GEJ-JPW	T	68.3/45.3
R606	7030005090	S.RES ERJ2GEJ 104 X (100K)	T	67.1/47.4
R607	7030005120	S.RES ERJ2GEJ 102 X (1K)	T	66.7/45.3
R701	7030005220	S.RES ERJ2GEJ 223 X (22K)	T	61.2/53.0
R702	7030005120	S.RES ERJ2GEJ 102 X (1K)	T	64.3/44.0
R703	7030004970	S.RES ERJ2GEJ 470 X (47)	T	50.8/44.1
R705	7030004990	S.RES ERJ2GEJ 221 X (220)	T	59.0/51.6
R706	7030009270	S.RES ERJ2GEJ 821 X (820)	T	64.6/56.0
R707	7030004980	S.RES ERJ2GEJ 101 X (100)	T	59.6/57.0
R708	7030007290	S.RES ERJ2GEJ 222 X (2.2K)	T	63.9/58.6
R709	7030005210	S.RES ERJ2GEJ 822 X (8.2K)	T	59.6/55.2
R710	7030005120	S.RES ERJ2GEJ 102 X (1K)	T	59.9/62.5
R711	7030009140	S.RES ERJ2GEJ 272 X (2.7K)	T	50.6/51.5
R712	7030005120	S.RES ERJ2GEJ 102 X (1K)	T	51.2/50.6
R713	7030005050	S.RES ERJ2GEJ 103 X (10K)	T	57.2/51.6
R715	7030004970	S.RES ERJ2GEJ 470 X (47)	T	52.2/54.2
R716	7030005710	S.RES ERJ2GEJ 121 X (120)	T	51.3/57.5
R717	7030007300	S.RES ERJ2GEJ 332 X (3.3K)	T	52.2/51.5
R718	7510001461	S.THE NTCG16 3NH 471JT	T	63.3/54.0
R801	7030008280	S.RES ERJ2GEJ 271 X (270)	T	86.9/57.2
R802	7030005120	S.RES ERJ2GEJ 102 X (1K)	T	65.3/60.9
R803	7030005120	S.RES ERJ2GEJ 102 X (1K)	T	72.0/65.0

Eqv.= This component is equivalent to the REF No. component listed above, and may be substituted on parts orders and repairs.

[MAIN UNIT]

REF NO.	PARTS NO.	DESCRIPTION	M.	H/V LOCATION
R804	7030005530	S.RES ERJ2GEJ 100 X (10)	T	91.2/57.2
R805	7030010090	S.RES ERJ2GEJ 180 X (18)	T	84.8/54.4
R806	7030008280	S.RES ERJ2GEJ 271 X (270)	T	85.3/55.3
R807	7030005120	S.RES ERJ2GEJ 102 X (1K)	T	62.8/64.6
R808	7030004970	S.RES ERJ2GEJ 470 X (47)	T	62.3/69.4
R809	7030008280	S.RES ERJ2GEJ 271 X (270)	T	82.8/60.6
R810	7030010090	S.RES ERJ2GEJ 180 X (18)	T	84.4/60.6
R811	7030008280	S.RES ERJ2GEJ 271 X (270)	T	82.8/59.7
R904	7030003860	S.RES ERJ3GE JPW V	T	36.5/68.1
R905	7030004980	S.RES ERJ2GEJ 101 X (100)	T	39.3/64.6
R906	7030007290	S.RES ERJ2GEJ 222 X (2.2K)	T	39.3/66.6
R908	7030005000	S.RES ERJ2GEJ 471 X (470)	T	35.7/62.0
R909	7030008410	S.RES ERJ2GEJ 392 X (3.9K)	T	34.3/68.4
R912	7030005210	S.RES ERJ2GEJ 822 X (8.2K)	T	34.3/66.6
R913	7030007300	S.RES ERJ2GEJ 332 X (3.3K)	T	40.6/75.1
R914	7030009290	S.RES ERJ2GEJ 562 X (5.6K)	T	35.6/71.5
R915	7030007290	S.RES ERJ2GEJ 222 X (2.2K)	T	36.6/75.0
R916	7030005050	S.RES ERJ2GEJ 103 X (10K)	T	37.2/75.5
R917	7030004970	S.RES ERJ2GEJ 470 X (47)	T	34.3/69.3
R918	7030007290	S.RES ERJ2GEJ 222 X (2.2K)	B	31.5/72.1
R919	7030004980	S.RES ERJ2GEJ 101 X (100)	T	31.5/72.2
R1009	7030009290	S.RES ERJ2GEJ 562 X (5.6K)	T	25.9/72.9
R1018	7030007290	S.RES ERJ2GEJ 222 X (2.2K)	T	20.3/75.1
R1019	7030005050	S.RES ERJ2GEJ 103 X (10K)	T	20.3/76.9
R1020	7030005000	S.RES ERJ2GEJ 471 X (470)	T	12.7/77.6
R1022	7510001461	S.THE NTCG16 3NH 471JT	T	14.8/76.8
R1023	7030008370	S.RES ERJ2GEJ 561 X (560)	T	15.3/77.9
R1024	7030004980	S.RES ERJ2GEJ 101 X (100)	T	12.7/77.9
R1025	7030007260	S.RES ERJ2GEJ 330 X (33)	T	12.7/76.7
R1027	7030005120	S.RES ERJ2GEJ 102 X (1K)	T	4.6/87.7
R1201	7030005000	S.RES ERJ2GEJ 471 X (470)	T	25.7/77.9
R1202	7030005240	S.RES ERJ2GEJ 473 X (47K)	T	24.1/78.6
R1203	7030005240	S.RES ERJ2GEJ 473 X (47K)	T	25.7/78.6
R1204	7030005240	S.RES ERJ2GEJ 473 X (47K)	T	20.2/79.2
R1205	7030005000	S.RES ERJ2GEJ 471 X (470)	T	20.2/78.3
R1206	7030005090	S.RES ERJ2GEJ 104 X (100K)	T	21.8/79.3
R1207	7030005240	S.RES ERJ2GEJ 473 X (47K)	T	18.0/83.6
R1208	7030004980	S.RES ERJ2GEJ 101 X (100)	T	9.4/79.9
R1209	7030004980	S.RES ERJ2GEJ 101 X (100)	T	16.5/79.9
R1211	7030005120	S.RES ERJ2GEJ 102 X (1K)	T	12.7/79.4
R1212	7030005120	S.RES ERJ2GEJ 102 X (1K)	T	11.1/78.5
R1213	7030005120	S.RES ERJ2GEJ 102 X (1K)	T	11.1/79.4
R1215	7030007350	S.RES ERJ2GEJ 393 X (39K)	T	8.1/81.3
R1216	7030007290	S.RES ERJ2GEJ 222 X (2.2K)	T	9.5/83.5
R1217	7030007290	S.RES ERJ2GEJ 222 X (2.2K)	T	8.0/82.2
R1218	7030005050	S.RES ERJ2GEJ 103 X (10K)	T	7.5/78.6
R1219	7030005050	S.RES ERJ2GEJ 103 X (10K)	T	7.5/79.8
R1301	7030010040	S.RES ERJ2GEJ-JPW	T	15.3/74.9
R1302	7030005120	S.RES ERJ2GEJ 102 X (1K)	T	15.3/72.7
R1303	7030005120	S.RES ERJ2GEJ 102 X (1K)	T	12.7/74.0
R1304	7030005120	S.RES ERJ2GEJ 102 X (1K)	T	14.9/68.3
R1305	7030005120	S.RES ERJ2GEJ 102 X (1K)	T	16.2/63.9
R1306	7030005120	S.RES ERJ2GEJ 102 X (1K)	T	10.9/56.8
R1308	7030007300	S.RES ERJ2GEJ 332 X (3.3K)	T	13.0/67.4
R1309	7030005120	S.RES ERJ2GEJ 102 X (1K)	T	11.4/66.5
R1310	7510001451	S.THE NTCG16 4BH 472JT	T	12.3/68.5
R1401	7030005120	S.RES ERJ2GEJ 102 X (1K)	B	45.4/72.4
R1402	7030008010	S.RES ERJ2GEJ 123 X (12K)	B	43.7/72.4
R1403	7030007290	S.RES ERJ2GEJ 222 X (2.2K)	B	44.6/73.4
R1404	7030007280	S.RES ERJ2GEJ 331 X (330)	B	44.6/75.3
R1405	7030004970	S.RES ERJ2GEJ 470 X (47)	B	42.1/71.5
R1406	7030005290	S.RES ERJ2GEJ 682 X (6.8K)	B	38.7/79.9
R1407	7030005120	S.RES ERJ2GEJ 102 X (1K)	B	38.7/79.0
R1408	7030007280	S.RES ERJ2GEJ 331 X (330)	B	38.7/80.8
R1409	7030004970	S.RES ERJ2GEJ 470 X (47)	B	34.7/80.0
R1414	7030007340	S.RES ERJ2GEJ 153 X (15K)	B	20.3/76.4
R1416	7030008410	S.RES ERJ2GEJ 392 X (3.9K)	B	19.5/83.1
R1420	7030004990	S.RES ERJ2GEJ 221 X (220)	B	25.1/76.9
R1421	7030007270	S.RES ERJ2GEJ 151 X (150)	B	23.2/75.9
R1422	7030004990	S.RES ERJ2GEJ 221 X (220)	B	23.3/76.8
R1501	7030010040	S.RES ERJ2GEJ-JPW	B	72.4/38.3
R1502	7030005100	S.RES ERJ2GEJ 154 X (150K)	B	86.5/55.4
R1503	7030005100	S.RES ERJ2GEJ 154 X (150K)	B	85.8/54.2
R1504	7030004970	S.RES ERJ2GEJ 470 X (47)	B	72.4/40.3
R1505	7030007290	S.RES ERJ2GEJ 222 X (2.2K)	B	71.8/54.0
R1506	7030007350	S.RES ERJ2GEJ 393 X (39K)	B	85.8/52.3

[MAIN UNIT]

REF NO.	PARTS NO.	DESCRIPTION	M.	H/V LOCATION
R1612	7030005060	S.RES ERJ2GEJ 333 X (33K)	T	3.4/42.3
R1613	7030003860	S.RES ERJ3GE JPW V	T	6.7/48.7
R1614	7030007310	S.RES ERJ2GEJ 155 X (1.5M)	T	6.1/45.8
R1615	7030005040	S.RES ERJ2GEJ 472 X (4.7K)	T	4.2/35.4
R1616	7030005090	S.RES ERJ2GEJ 104 X (100K)	T	6.7/35.4
R1617	7030005720	S.RES ERJ2GEJ 563 X (56K)	T	3.5/38.2
R1618	7310005540	S.TRI TMC3ADC14X (10K)	T	3.5/46.3
R1619	7030005080	S.RES ERJ2GEJ 823 X (82K)	T	2.6/43.3
	7030005080	S.RES ERJ2GEJ 823 X (82K)	[EUR]	
	7030005080	S.RES ERJ2GEJ 823 X (82K)	[FRA]	
	7030005080	S.RES ERJ2GEJ 823 X (82K)	[ESP]	
	7030005080	S.RES ERJ2GEJ 823 X (82K)	[USA]	
	7030005080	S.RES ERJ2GEJ 823 X (82K)	[ITR]	
	7030005080	S.RES ERJ2GEJ 823 X (82K)	[UK]	
	7030005080	S.RES ERJ2GEJ 823 X (82K)	[KOR]	
	7030005720	S.RES ERJ2GEJ 563 X (56K)	[AUS]	
	7030005080	S.RES ERJ2GEJ 823 X (82K)	[CHN]	
R1620	7030008290	S.RES ERJ2GEJ 183 X (18K)	T	3.5/37.3
R1621	7030005160	S.RES ERJ2GEJ 105 X (1M)	T	6.7/37.2
R1622	7030010040	S.RES ERJ2GEJ-JPW	T	5.1/37.3
R1623	7030005000	S.RES ERJ2GEJ 471 X (470)	T	12.0/46.9
R1624	7030007250	S.RES ERJ2GEJ 220 X (22)	T	14.9/38.3
R1625	7030004990	S.RES ERJ2GEJ 221 X (220)	T	13.6/32.6
R1626	7030005050	S.RES ERJ2GEJ 103 X (10K)	T	10.3/34.6
R1627	7030007320	S.RES ERJ2GEJ 225 X (2.2M)	T	10.3/35.5
R1628	7030005120	S.RES ERJ2GEJ 102 X (1K)	T	4.9/30.8
R1629	7030005050	S.RES ERJ2GEJ 103 X (10K)	T	4.9/29.9
R1630	7030004980	S.RES ERJ2GEJ 101 X (100)	T	8.3/45.8
R1631	7030005090	S.RES ERJ2GEJ 104 X (100K)	T	9.9/37.3
R1634	7030005040	S.RES ERJ2GEJ 472 X (4.7K)	T	10.3/33.7
R1636	7030007320	S.RES ERJ2GEJ 225 X (2.2M)	T	13.0/31.7
R1637	7030007320	S.RES ERJ2GEJ 225 X (2.2M)	T	12.0/46.0
R1638	7030008280	S.RES ERJ2GEJ 271 X (270)	T	10.9/48.9
R1639	7030005120	S.RES ERJ2GEJ 102 X (1K)	T	14.6/50.5
R1640	7030005090	S.RES ERJ2GEJ 104 X (100K)	T	11.0/31.6
R1641	7030007320	S.RES ERJ2GEJ 225 X (2.2M)	T	13.0/30.8
R1642	7030005120	S.RES ERJ2GEJ 102 X (1K)	T	22.9/55.2
R1701	7030009320	S.RES ERJ2GEJ 4R7 X (4.7)	T	48.1/45.3
R1702	7030007280	S.RES ERJ2GEJ 331 X (330)	B	52.2/44.7
R1703	7030007280	S.RES ERJ2GEJ 331 X (330)	B	53.8/43.8
R1704	7030007280	S.RES ERJ2GEJ 331 X (330)	B	53.8/44.7
R1705	7030009320	S.RES ERJ2GEJ 4R7 X (4.7)	T	48.1/46.2
R1706	7030007280	S.RES ERJ2GEJ 331 X (330)	B	53.6/64.2
R1707	7030007280	S.RES ERJ2GEJ 331 X (330)	B	55.7/64.8
R1708	7030007280	S.RES ERJ2GEJ 331 X (330)	B	55.7/65.7
R1901	7030005090	S.RES ERJ2GEJ 104 X (100K)	B	20.0/14.0
R1902	7030011290	S.RES ERJ12YJ1R8U (1.8)	B	12.4/45.9
R1952	7030009980	S.RES ERJ12RSJR15U	B	42.6/102.3
R1953	7030009980	S.RES ERJ12RSJR15U	B	42.6/98.6
R1954	7030005170	S.RES ERJ2GEJ 474 X (470K)	B	42.7/111.4
R1955	7030005511	S.RES ERA3YED 303V (30K)	B	44.8/107.4
R1956	7030005110	S.RES ERJ2GEJ 224 X (220K)	B	33.7/105.2
R1957	7030007350	S.RES ERJ2GEJ 393 X (39K)	B	35.3/104.3
R1958	7030005720	S.RES ERJ2GEJ 563 X (56K)	B	35.3/103.4
R1981	7030008240	S.RES ERJ12Y0R00U	B	83.1/109.0
R2002	7030010040	S.RES ERJ2GEJ-JPW	B	36.9/12.8
R2003	7030008240	S.RES ERJ12Y0R00U	T	55.7/7.9
R2004	7030004990	S.RES ERJ2GEJ 221 X (220)	B	59.8/9.3
R2005	7030004990	S.RES ERJ2GEJ 221 X (220)	B	59.1/3.0
R2006	7030004990	S.RES ERJ2GEJ 221 X (220)	B	60.7/3.7
R2007	7030004990	S.RES ERJ2GEJ 221 X (220)	B	60.7/4.6
R2008	7030010040	S.RES ERJ2GEJ-JPW	B	34.1/17.7
R2010	7030010040	S.RES ERJ2GEJ-JPW	B	32.5/15.2
R2011	7030006210	S.RES ERJ12Y4R7U (4.7)	B	13.2/26.4
R2012	7030005120	S.RES ERJ2GEJ 102 X (1K)	B	32.5/17.3
R2101	7030005090	S.RES ERJ2GEJ 104 X (100K)	T	26.1/113.8
R2102	7030005090	S.RES ERJ2GEJ 104 X (100K)	T	33.2/114.2
R2103	7030005090	S.RES ERJ2GEJ 104 X (100K)	T	30.7/123.4
R2104	7030005090	S.RES ERJ2GEJ 104 X (100K)	T	28.1/123.2
R2105	7030005090	S.RES ERJ2GEJ 104 X (100K)	T	32.4/118.8
R2106	7030005720	S.RES ERJ2GEJ 563 X (56K)	T	25.0/115.5
R2107	7030005720	S.RES ERJ2GEJ 563 X (56K)	T	31.6/114.7
R2108	7030005100	S.RES ERJ2GEJ 154 X (150K)	T	30.8/122.3
R2109	7030007350	S.RES ERJ2GEJ 393 X (39K)	T	27.1/122.3
R2110	7030005090	S.RES ERJ2GEJ 104 X (100K)	T	44.3/111.9
R2111	7030005090	S.RES ERJ2GEJ 104 X (100K)	T	44.8/110.1
R2112	7030005090	S.RES ERJ2GEJ 104 X (100K)	T	54.2/110.9
R2113	7030005090	S.RES ERJ2GEJ 104 X (100K)	T	54.2/111.8
R2114	7030005100	S.RES ERJ2GEJ 154 X (150K)	T	44.8/112.8
R2115	7030005100	S.RES ERJ2GEJ 154 X (150K)	T	44.8/109.2
R2116	7030005100	S.RES ERJ2GEJ 154 X (150K)	T	54.4/110.0
R2117	7030005100	S.RES ERJ2GEJ 154 X (150K)	T	54.2/112.7
R2118	7030005090	S.RES ERJ2GEJ 104 X (100K)	T	54.2/120.6
R2119	7030005090	S.RES ERJ2GEJ 104 X (100K)	T	54.2/121.8
R2120	7030008300	S.RES ERJ2GEJ 184 X (180K)	T	44.8/122.1
R2121	7030008300	S.RES ERJ2GEJ 184 X (180K)	T	42.9/121.3
R2122	7030005100	S.RES ERJ2GEJ 154 X (150K)	T	54.2/119.7
R2123	7030006610	S.RES ERJ2GEJ 394 X (390K)	T	54.2/122.8
R2124	7030005110	S.RES ERJ2GEJ 224 X (220K)	T	44.8/123.0
R2125	7030005110	S.RES ERJ2GEJ 224 X (220K)	T	44.9/119.4
R2126	7030010040	S.RES ERJ2GEJ-JPW	T	33.1/116.5
R2128	7030005000	S.RES ERJ2GEJ 471 X (470)	T	32.3/123.2
R2129	7030005000	S.RES ERJ2GEJ 471 X (470)	T	54.2/118.8
R2131	7030005090	S.RES ERJ2GEJ 104 X (100K)	B	39.9/122.1
R2132	7030005090	S.RES ERJ2GEJ 104 X (100K)	T	42.9/115.2
R2133	7030005090	S.RES ERJ2GEJ 104 X (100K)	T	40.6/114.1
R2134	7030005090	S.RES ERJ2GEJ 104 X (100K)	T	36.6/114.1
R2135	7030005090	S.RES ERJ2GEJ 104 X (100K)	T	35.0/114.2
R2136	7030005000	S.RES ERJ2GEJ 471 X (470)	T	26.5/123.2
R2137	7030005230	S.RES ERJ2GEJ 334 X (330K)	T	43.3/123.7
R2138	7030005230	S.RES ERJ2GEJ 334 X (330K)	T	42.9/122.2
R2139	7030004980	S.RES ERJ2GEJ 101 X (100)	T	25.0/116.4
R2140	7030004980	S.RES ERJ2GEJ 101 X (100)	T	32.0/115.6
R2141	7030010040	S.RES ERJ2GEJ-JPW	T	44.8/113.7
R2142	7030010040	S.RES ERJ2GEJ-JPW	T	52.7/109.0
R2143	7030010040	S.RES ERJ2GEJ-JPW	T	56.0/110.0

Eqv.= This component is equivalent to the REF No. component listed above, and may be substituted on parts orders and repairs.

[MAIN UNIT]

REF NO.	PARTS NO.	DESCRIPTION	M.	H/V LOCATION
R2144	70300010040	S.RES ERJ2GEJ-JPW	T	51.3/115.2
R2145	70300010040	S.RES ERJ2GEJ-JPW	T	58.1/123.6
R2146	70300010040	S.RES ERJ2GEJ-JPW	T	46.3/124.0
R2147	70300010040	S.RES ERJ2GEJ-JPW	T	46.0/118.5
R2151	7030005240	S.RES ERJ2GEJ 473 X (47K)	T	52.4/101.8
R2152	7030005120	S.RES ERJ2GEJ 102 X (1K)	T	56.5/107.2
R2153	7030005240	S.RES ERJ2GEJ 473 X (47K)	T	24.9/112.6
R2154	7030005120	S.RES ERJ2GEJ 102 X (1K)	T	25.6/111.6
R2155	7030005240	S.RES ERJ2GEJ 473 X (47K)	T	46.2/104.7
R2156	7030005120	S.RES ERJ2GEJ 102 X (1K)	T	46.2/105.6
R2157	7030005530	S.RES ERJ2GEJ 100 X (10)	B	33.3/120.8
R2158	7030005530	S.RES ERJ2GEJ 100 X (10)	B	33.3/119.9
R2159	7030005530	S.RES ERJ2GEJ 100 X (10)	B	35.1/118.4
R2160	7030005530	S.RES ERJ2GEJ 100 X (10)	B	40.7/94.4
R2161	7030005530	S.RES ERJ2GEJ 100 X (10)	B	40.7/95.3
R2162	7030005530	S.RES ERJ2GEJ 100 X (10)	B	30.2/93.8
R2163	7030005530	S.RES ERJ2GEJ 100 X (10)	B	31.0/95.9
R2164	7030005530	S.RES ERJ2GEJ 100 X (10)	B	30.2/94.7
R2165	7030005530	S.RES ERJ2GEJ 100 X (10)	B	29.4/95.9
R2166	7030005530	S.RES ERJ2GEJ 100 X (10)	T	51.9/93.4
R2167	7030005530	S.RES ERJ2GEJ 100 X (10)	T	51.9/94.3
R2168	7030005530	S.RES ERJ2GEJ 100 X (10)	T	51.9/95.2
R2169	7030005120	S.RES ERJ2GEJ 102 X (1K)	T	8.8/118.6
R2170	7030005170	S.RES ERJ2GEJ 474 X (470K)	T	5.0/104.5
R2171	7030005240	S.RES ERJ2GEJ 473 X (47K)	T	9.8/114.3
R2172	7030005240	S.RES ERJ2GEJ 473 X (47K)	T	5.1/112.5
R2174	7030005170	S.RES ERJ2GEJ 474 X (470K)	T	5.0/105.4
R2175	7030005170	S.RES ERJ2GEJ 474 X (470K)	T	5.1/111.5
R2176	7030005170	S.RES ERJ2GEJ 474 X (470K)	T	11.4/114.3
R2177	7030005210	S.RES ERJ2GEJ 822 X (8.2K)	T	3.4/108.1
R2202	7030010040	S.RES ERJ2GEJ-JPW	T	26.5/124.1
R2203	7030005080	S.RES ERJ2GEJ 823 X (82K)	T	25.1/122.4
R2204	7030005050	S.RES ERJ2GEJ 103 X (10K)	T	23.5/122.7
R2205	7030005040	S.RES ERJ2GEJ 472 X (4.7K)	T	18.2/118.3
R2206	7030007270	S.RES ERJ2GEJ 151 X (150)	T	12.6/118.8
R2207	7030005090	S.RES ERJ2GEJ 104 X (100K)	T	23.2/121.5
R2208	7030005090	S.RES ERJ2GEJ 104 X (100K)	T	19.1/119.2
R2209	7030004980	S.RES ERJ2GEJ 101 X (100)	T	21.1/116.6
R2211	7030005230	S.RES ERJ2GEJ 334 X (330K)	T	14.6/123.4
R2212	7030005310	S.RES ERJ2GEJ 124 X (120K)	T	13.0/123.4
R2213	7030008010	S.RES ERJ2GEJ 123 X (12K)	T	12.4/124.3
R2214	7030005050	S.RES ERJ2GEJ 103 X (10K)	T	8.8/117.7
R2215	7030005040	S.RES ERJ2GEJ 472 X (4.7K)	T	11.2/120.6
R2217	7030007280	S.RES ERJ2GEJ 331 X (330)	T	24.9/121.5
R2218	7030007270	S.RES ERJ2GEJ 151 X (150)	T	15.5/127.5
R2219	7030007280	S.RES ERJ2GEJ 331 X (330)	T	17.7/126.1
R2220	7030008280	S.RES ERJ2GEJ 271 X (270)	T	9.6/126.1
R2221	7030005050	S.RES ERJ2GEJ 103 X (10K)	T	16.2/120.6
R2230	7030010900	S.RES ERJ3GEYJ 750 V (75)	T	40.5/105.8
R2231	7030005050	S.RES ERJ2GEJ 103 X (10K)	T	4.5/118.2
R2232	7030005050	S.RES ERJ2GEJ 103 X (10K)	T	54.7/117.5
R2251	7030004990	S.RES ERJ2GEJ 221 X (220)	T	6.2/96.9
R2254	7030004990	S.RES ERJ2GEJ 221 X (220)	B	6.8/100.8
R2255	7030004990	S.RES ERJ2GEJ 221 X (220)	B	6.8/101.7
R2256	7030004990	S.RES ERJ2GEJ 221 X (220)	B	6.8/102.6
R2257	7030004990	S.RES ERJ2GEJ 221 X (220)	B	75.3/109.0
R2258	7030004990	S.RES ERJ2GEJ 221 X (220)	B	71.0/106.6
R2259	7030004990	S.RES ERJ2GEJ 221 X (220)	B	75.3/107.8
R2260	7030004990	S.RES ERJ2GEJ 221 X (220)	B	71.0/105.6
R2261	7030004990	S.RES ERJ2GEJ 221 X (220)	B	75.3/106.6
R2262	7030004990	S.RES ERJ2GEJ 221 X (220)	B	75.5/104.6
R2263	7030004990	S.RES ERJ2GEJ 221 X (220)	B	71.6/104.5
R2264	7030004990	S.RES ERJ2GEJ 221 X (220)	B	72.3/103.6
R2267	7030004990	S.RES ERJ2GEJ 221 X (220)	T	78.6/104.2
R2268	7030004990	S.RES ERJ2GEJ 221 X (220)	T	78.6/103.3
R2269	7030004990	S.RES ERJ2GEJ 221 X (220)	T	78.6/102.4
R2270	7030004970	S.RES ERJ2GEJ 470 X (47)	T	76.6/101.8
R2271	7030004990	S.RES ERJ2GEJ 221 X (220)	T	76.6/100.9
R2272	7030004990	S.RES ERJ2GEJ 221 X (220)	B	78.1/97.8
R2273	7030004990	S.RES ERJ2GEJ 221 X (220)	B	78.1/98.9
R2274	7030005000	S.RES ERJ2GEJ 471 X (470)	T	14.2/89.5
R2277	7030005090	S.RES ERJ2GEJ 104 X (100K)	T	19.3/89.8
R2278	7030005090	S.RES ERJ2GEJ 104 X (100K		

[MAIN UNIT]

REF NO.	PARTS NO.	DESCRIPTION	M.	H/V LOCATION
R2510	7030005120	S.RES ERJ2GEJ 102 X (1K)	B	17.4/92.8
R2513	7030005000	S.RES ERJ2GEJ 471 X (470)	B	15.8/94.0
R2551	7030005120	S.RES ERJ2GEJ 102 X (1K)	B	43.0/123.2
R2552	7030005120	S.RES ERJ2GEJ 102 X (1K)	B	43.0/122.3
R2555	7030004980	S.RES ERJ2GEJ 101 X (100)	B	51.5/119.4
R2556	7030005040	S.RES ERJ2GEJ 472 X (4.7K)	B	44.5/125.2
R2559	7030010040	S.RES ERJ2GEJ-JPW	B	49.5/124.7
R2560	7030008410	S.RES ERJ2GEJ 392 X (3.9K)	B	49.5/125.6
R2561	7030008410	S.RES ERJ2GEJ 392 X (3.9K)	B	53.0/124.7
R2562	7030008410	S.RES ERJ2GEJ 392 X (3.9K)	B	53.9/122.9
R2564	7030005090	S.RES ERJ2GEJ 104 X (100K)	B	46.1/126.1
R2565	7030009280	S.RES ERJ2GEJ 391 X	B	41.9/116.9
R2566	7030005050	S.RES ERJ2GEJ 103 X (10K)	B	59.1/126.8
R2567	7030005050	S.RES ERJ2GEJ 103 X (10K)	B	60.7/126.8
R2568	7030005040	S.RES ERJ2GEJ 472 X (4.7K)	B	47.8/124.7
R2569	7030005040	S.RES ERJ2GEJ 472 X (4.7K)	B	46.1/125.2
R2601	7030010040	S.RES ERJ2GEJ-JPW	B	66.8/123.5
R2602	7030005000	S.RES ERJ2GEJ 471 X (470)	B	57.2/122.7
R2603	7030005240	S.RES ERJ2GEJ 473 X (47K)	B	63.5/121.8
R2604	7030008400	S.RES ERJ2GEJ 182 X (1.8K)	B	66.7/124.4
R2605	7030005120	S.RES ERJ2GEJ 102 X (1K)	B	65.6/126.0
R2607	7030010040	S.RES ERJ2GEJ-JPW	T	40.5/132.2
R2608	7030009320	S.RES ERJ2GEJ 4R7 X (4.7)	B	83.9/132.8
R2611	7030005050	S.RES ERJ2GEJ 103 X (10K)	B	34.0/124.8
R2612	7030005090	S.RES ERJ2GEJ 104 X (100K)	B	38.5/125.4
R2613	7030005080	S.RES ERJ2GEJ 823 X (82K)	B	38.5/123.6
R2614	7030005120	S.RES ERJ2GEJ 102 X (1K)	B	34.7/126.6
R2617	7030005040	S.RES ERJ2GEJ 472 X (4.7K)	T	63.4/111.1
R2618	7030007340	S.RES ERJ2GEJ 153 X (15K)	T	69.4/112.7
R2619	7030005060	S.RES ERJ2GEJ 333 X (33K)	T	63.4/112.2
R2620	7030005120	S.RES ERJ2GEJ 102 X (1K)	T	78.1/100.3
R2621	7030005120	S.RES ERJ2GEJ 102 X (1K)	T	78.1/99.4
R2623	7030005240	S.RES ERJ2GEJ 473 X (47K)	T	9.9/112.9
R2624	7030004970	S.RES ERJ2GEJ 470 X (47K)	B	86.9/122.0
R2628	7030005240	S.RES ERJ2GEJ 473 X (47K)	B	61.9/121.8
C5	4030017460	S.CER C1005 JB 1H 102K-T	B	47.5/30.8
C6	4030018960	S.CER C3216 JB 1C 106MT-N	T	66.3/12.0
C7	4030017330	S.CER C1005 JF 1C 104Z-T	T	73.1/12.2
C8	4030017330	S.CER C1005 JF 1C 104Z-T	T	77.3/9.1
C9	4030017330	S.CER C1005 JF 1C 104Z-T	T	73.1/14.0
C10	4030017330	S.CER C1005 JF 1C 104Z-T	T	74.8/14.9
C11	4030017330	S.CER C1005 JF 1C 104Z-T	T	73.1/17.6
C12	4030017330	S.CER C1005 JF 1C 104Z-T	T	76.4/16.7
C13	4030017330	S.CER C1005 JF 1C 104Z-T	T	72.6/16.7
C14	4030017460	S.CER C1005 JB 1H 102K-T	T	67.7/16.6
C15	4030017460	S.CER C1005 JB 1H 102K-T	T	63.7/14.8
C16	4030017460	S.CER C1005 JB 1H 102K-T	T	63.7/15.7
C17	4030017460	S.CER C1005 JB 1H 102K-T	T	62.3/18.8
C18	4030017620	S.CER C1005 CH 1H 100C-T	T	60.7/18.9
C21	4030017730	S.CER C1005 JB 1H 471K-T	T	64.5/13.9
C25	4030017580	S.CER C1005 CH 1H 060C-T	T	55.2/17.9
C26	4030017660	S.CER C1005 CH 1H 330J-T	T	55.2/18.8
C27	4030017780	S.CER C1005 JB 1H 472K-T	T	51.7/20.5
C28	4030017530	S.CER C1005 CH 1H 0R5B-T	T	53.8/17.2
C29	4030017590	S.CER C1005 CH 1H 070C-T	T	51.7/19.6
C30	4030017730	S.CER C1005 JB 1H 471K-T	T	45.9/17.5
C31	4030017530	S.CER C1005 CH 1H 0R5B-T	T	53.8/16.3
C32	4030017660	S.CER C1005 CH 1H 330J-T	T	52.1/17.4
C33	4030017580	S.CER C1005 CH 1H 060C-T	T	52.2/16.5
C34	4030017380	S.CER C1005 CH 1H 050B-T	T	56.0/15.0
C35	4030017380	S.CER C1005 CH 1H 050B-T	T	56.0/12.5
C36	4030017730	S.CER C1005 JB 1H 471K-T	T	51.0/15.7
C37	4030017780	S.CER C1005 JB 1H 472K-T	T	70.4/11.4
C38	4030017780	S.CER C1005 JB 1H 472K-T	T	45.9/18.4
C40	4030017730	S.CER C1005 JB 1H 471K-T	T	73.1/13.1
C41	4030017730	S.CER C1005 JB 1H 471K-T	T	66.9/19.7
C42	4030017730	S.CER C1005 JB 1H 471K-T	T	70.4/12.3
C43	4030017420	S.CER C1005 CH 1H 470J-T	T	45.9/16.6
C44	4030017420	S.CER C1005 CH 1H 470J-T	T	48.0/11.7
C50	4030017640	S.CER C1005 CH 1H 150J-T	B	80.5/13.6
C51	4030017640	S.CER C1005 CH 1H 150J-T	B	79.9/11.8
C52	4030017430	S.CER C1005 CH 1H 101J-T	B	79.9/12.7
C53	4030016930	S.CER C1005 JB 1A 104K-T	B	79.7/22.0
C54	4030016930	S.CER C1005 JB 1A 104K-T	T	79.8/12.9
C55	4030016930	S.CER C1005 JB 1A 104K-T	T	78.1/17.9
C56	4030018860	S.CER C1005 JB 0J 105K-T	B	65.6/22.7
C58	4030017710	S.CER C1005 CH 1H 181J-T	T	72.2/19.4
C59	4030017710	S.CER C1005 CH 1H 181J-T	T	65.5/23.7
C101	4030017330	S.CER C1005 JF 1C 104Z-T	T	10.3/15.5
C102	4030017330	S.CER C1005 JF 1C 104Z-T	T	13.2/16.9
C103	4030017330	S.CER C1005 JF 1C 104Z-T	T	13.2/17.8
C104	4030017330	S.CER C1005 JF 1C 104Z-T	T	3.3/29.9
C105	4030017330	S.CER C1005 JF 1C 104Z-T	T	13.2/19.6
C106	4030017850	S.CER C2012 CH 1H 272J-T	T	82.8/11.0
C107	4030017330	S.CER C1005 JF 1C 104Z-T	T	19.2/12.9
C108	4030017330	S.CER C1005 JF 1C 104Z-T	T	36.5/16.6
C109	4030017330	S.CER C1005 JF 1C 104Z-T	T	25.2/14.0
C110	4030017800	S.CER C1608 CH 1H 561J-T	T	27.9/7.8
C111	4030018590	S.CER C1608 CH 1H 122J-T	T	29.2/5.0
C112	4030017330	S.CER C1005 JF 1C 104Z-T	T	23.9/5.3
C114	4030018600	S.CER C1608 CH 1H 152J-T	T	25.2/15.1
C115	4030008490	S.CER C2012 JB 1H 682K-T	T	24.8/16.7
C116	4030017850	S.CER C2012 CH 1H 272J-T	T	24.8/18.5
C117	4030017330	S.CER C1005 JF 1C 104Z-T	T	19.9/7.1
C118	4030017330	S.CER C1005 JF 1C 104Z-T	T	38.3/17.6
C119	4030017780	S.CER C1005 JB 1H 472K-T	T	7.8/22.2
C120	4030017330	S.CER C1005 JF 1C 104Z-T	T	7.8/21.3
C121	4030017330	S.CER C1005 JF 1C 104Z-T	T	5.7/12.9
C122	4030017330	S.CER C1005 JF 1C 104Z-T	T	13.2/18.7
C123	4030017330	S.CER C1005 JF 1C 104Z-T	T	15.4/14.4
C124	4030017330	S.CER C1005 JF 1C 104Z-T	T	16.4/15.3
C125	4030017460	S.CER C1005 JB 1H 102K-T	T	40.0/21.8
C126	4030017460	S.CER C1005 JB 1H 102K-T	T	37.1/22.4

Eqv.= This component is equivalent to the REF No. component listed above, and may be substituted on parts orders and repairs.

[MAIN UNIT]

REF NO.	PARTS NO.	DESCRIPTION	M.	H/V LOCATION
C127	4030017460	S.CER C1005 JB 1H 102K-T	B	19.2/23.1
C208	4030017330	S.CER C1005 JF 1C 104Z-T	T	19.8/31.2
C209	4030017680	S.CER C1005 CH 1H 820J-T	T	18.5/41.4
C210	4030017610	S.CER C1005 CH 1H 090C-T	T	18.5/40.3
C211	4030017700	S.CER C1005 CH 1H 151J-T	T	18.5/42.3
C212	4030017650	S.CER C1005 CH 1H 270J-T	T	23.3/39.2
C213	4030017510	S.CER C1005 CH 1H 680J-T	T	21.8/43.4
C214	4030018820	S.CER C1005 JB 1H 561K-T	T	31.7/54.4
C215	4030017440	S.CER C1005 CH 1H 221J-T	T	37.0/54.6
C226	4030017330	S.CER C1005 JF 1C 104Z-T	T	24.1/43.4
C227	4030017330	S.CER C1005 JF 1C 104Z-T	T	19.8/30.3
C228	4030017430	S.CER C1005 CH 1H 101J-T	T	28.2/39.2
C229	4030017440	S.CER C1005 CH 1H 221J-T	T	29.8/39.2
C237	4030017500	S.CER C1005 CH 1H 560J-T	T	28.2/38.2
C238	4030017330	S.CER C1005 JF 1C 104Z-T	T	21.9/30.9
C239	4030017330	S.CER C1005 JF 1C 104Z-T	B	24.7/41.5
C240	4030017400	S.CER C1005 CH 1H 220J-T	B	28.2/43.7
C241	4030017580	S.CER C1005 CH 1H 060C-T	B	31.6/40.1
C242	4030017680	S.CER C1005 CH 1H 820J-T	B	31.6/41.0
C243	4030018630	S.CER C2012 CH 1H 472J-T	T	32.5/57.8
C244	4030018680	S.CER C2012 CH 1H 822J-T	T	36.8/57.8
C245	4030017330	S.CER C1005 JF 1C 104Z-T	T	45.8/63.2
C246	4030018600	S.CER C1608 CH 1H 152J-T	T	36.5/56.1
C247	4030017860	S.CER C2012 CH 1H 332J-T	T	40.3/54.1
C248	4030018630	S.CER C2012 CH 1H 472J-T	T	43.8/57.9
C249	4030017330	S.CER C1005 JF 1C 104Z-T	B	24.9/56.5
C250	4030017330	S.CER C1005 JF 1C 104Z-T	B	24.9/53.4
C251	4030018590	S.CER C1608 CH 1H 122J-T	T	30.6/51.0
C252	4030011340	S.CER C1608 CH 1H 471J-T	T	32.0/48.6
C253	4030018630	S.CER C2012 CH 1H 472J-T	T	29.1/53.3
C254	4030018620	S.CER C1608 CH 1H 222J-T	T	38.1/50.8
C255	4030018580	S.CER C1608 CH 1H 821J-T	T	32.6/55.9
C256	4030010760	S.CER C1608 CH 1H 331J-T	T	38.1/52.1
C257	4030018610	S.CER C1608 CH 1H 182J-T	T	34.4/53.4
C258	4030017870	S.CER C1608 CH 1H 681J-T	T	40.7/52.3
C259	4030018590	S.CER C1608 CH 1H 122J-T	T	37.1/53.4
C260	4030017870	S.CER C1608 CH 1H 681J-T	T	40.7/47.9
C261	4030017780	S.CER C1005 JB 1H 472K-T	B	38.0/56.3
C262	4030017780	S.CER C1005 JB 1H 472K-T	B	38.0/53.8
C263	4030017330	S.CER C1005 JF 1C 104Z-T	B	24.6/50.3
C264	4030017330	S.CER C1005 JF 1C 104Z-T	B	23.9/47.2
C265	4030011280	S.CER C1608 CH 1H 271J-T	B	36.4/44.0
C266	4030017700	S.CER C1005 CH 1H 151J-T	B	31.0/46.1
C267	4030018590	S.CER C1608 CH 1H 122J-T	B	36.4/49.6
C268	4030018580	S.CER C1608 CH 1H 821J-T	B	31.8/43.0
C269	4030017710	S.CER C1005 CH 1H 181J-T	B	36.5/47.2
C270	4030017430	S.CER C1005 CH 1H 101J-T	B	32.7/44.1
C271	4030011330	S.CER C1608 CH 1H 391J-T	B	36.4/48.3
C272	4030011280	S.CER C1608 CH 1H 271J-T	B	36.4/43.9
C273	4030011330	S.CER C1608 CH 1H 391J-T	B	38.8/47.3
C274	4030017730	S.CER C1005 JB 1H 471K-T	B	34.3/43.7
C275	4030017780	S.CER C1005 JB 1H 472K-T	B	43.0/49.7
C276	4030017780	S.CER C1005 JB 1H 472K-T	B	39.3/46.3
C278	4030017330	S.CER C1005 JF 1C 104Z-T	T	30.9/31.9
C279	4030017330	S.CER C1005 JF 1C 104Z-T	T	31.0/43.9
C281	4030017330	S.CER C1005 JF 1C 104Z-T	T	33.0/31.7
C282	4030017650	S.CER C1005 CH 1H 207J-T	B	31.6/39.2
C283	4030017330	S.CER C1005 JF 1C 104Z-T	B	35.9/35.9
C284	4030017780	S.CER C1005 JB 1H 472K-T	B	42.7/43.3
C285	4030017380	S.CER C1005 CH 1H 050B-T	B	33.2/39.5
C286	4030017510	S.CER C1005 CH 1H 680J-T	B	34.8/39.5
C287	4030017690	S.CER C1005 CH 1H 121J-T	B	36.6/37.9
C288	4030017680	S.CER C1005 CH 1H 820J-T	B	34.3/36.3
C289	4030017420	S.CER C1005 CH 1H 470J-T	B	36.4/36.8
C290	4030018600	S.CER C1608 CH 1H 152J-T	B	38.8/37.6
C291	4030017680	S.CER C1005 CH 1H 820J-T	B	38.0/36.6
C292	4030017330	S.CER C1005 JF 1C 104Z-T	T	30.9/30.0
C293	4030017780	S.CER C1005 JB 1H 472K-T	T	38.2/34.9
C294	4030017440	S.CER C1005 CH 1H 221J-T	B	38.6/49.7
C295	4030017510	S.CER C1005 CH 1H 680J-T	T	40.4/51.2
C301	4030017330	S.CER C1005 JF 1C 104Z-T	T	47.1/30.1
C302	4030017330	S.CER C1005 JF 1C 104Z-T	B	

[MAIN UNIT]

REF NO.	PARTS NO.	DESCRIPTION	M.	H/V LOCATION
C431	4030017330	S.CER C1005 JF 1C 104Z-T	T	88.6/26.7
C432	4030017780	S.CER C1005 JB 1H 472K-T	B	88.6/19.3
C433	4030017780	S.CER C1005 JB 1H 472K-T	T	88.9/20.3
C434	4030017780	S.CER C1005 JB 1H 472K-T	T	86.8/23.0
C511	4030017460	S.CER C1005 JB 1H 102K-T	T	41.9/26.8
C512	4030017780	S.CER C1005 JB 1H 472K-T	T	93.6/33.5
C513	4030017330	S.CER C1005 JF 1C 104Z-T	T	88.5/28.3
C514	4030017330	S.CER C1005 JF 1C 104Z-T	B	88.3/31.7
C515	4030017780	S.CER C1005 JB 1H 472K-T	T	81.8/33.2
C516	4030017580	S.CER C1005 CH 1H 060C-T	T	86.1/38.7
C518	4030017570	S.CER C1005 CH 1H 040B-T	T	86.9/36.5
C525	4030017330	S.CER C1005 JF 1C 104Z-T	T	81.8/32.3
C526	4030016790	S.CER C1005 JB 1E 103K-T	T	78.0/38.3
C527	4030017330	S.CER C1005 JF 1C 104Z-T	T	79.6/38.0
C528	4030017330	S.CER C1005 JF 1C 104Z-T	T	89.7/35.2
C529	4030017670	S.CER C1005 CH 1H 390J-T	T	91.3/33.8
C530	4030017460	S.CER C1005 JB 1H 102K-T	B	87.7/34.2
C602	4030017570	S.CER C1005 CH 1H 040B-T	B	85.7/39.7
C603	4030017780	S.CER C1005 JB 1H 472K-T	T	89.2/40.1
C604	4030017780	S.CER C1005 JB 1H 472K-T	T	94.1/46.5
C605	4030017620	S.CER C1005 CH 1H 100C-T	T	86.0/44.2
C606	4030017620	S.CER C1005 CH 1H 100C-T	B	85.7/41.5
C608	4030017550	S.CER C1005 CH 1H 1R5B-T	B	82.6/43.9
C609	4030017580	S.CER C1005 CH 1H 060C-T	B	78.7/46.8
C610	4030017620	S.CER C1005 CH 1H 100C-T	B	82.6/44.8
C611	4030017780	S.CER C1005 JB 1H 472K-T	B	85.2/37.6
C612	4030017610	S.CER C1005 CH 1H 090C-T	T	79.5/40.5
C613	4030017620	S.CER C1005 CH 1H 100C-T	T	76.6/43.8
C614	4030017780	S.CER C1005 JB 1H 472K-T	T	69.7/38.9
C615	4030017780	S.CER C1005 JB 1H 472K-T	T	64.3/43.1
C616	4030017780	S.CER C1005 JB 1H 472K-T	T	77.4/39.5
C617	4030017620	S.CER C1005 CH 1H 100C-T	B	85.7/40.6
C618	4030017620	S.CER C1005 CH 1H 100C-T	B	81.0/44.8
C701	4030017330	S.CER C1005 JF 1C 104Z-T	T	59.0/50.7
C702	4030017330	S.CER C1005 JF 1C 104Z-T	T	63.0/45.1
C703	4510008630	S.ELE 16 CE 47 FE	B	59.0/45.0
C704	4030017780	S.CER C1005 JB 1H 472K-T	T	58.7/43.0
C705	4030017600	S.CER C1005 CH 1H 080C-T	T	59.6/45.1
C707	4030017330	S.CER C1005 JF 1C 104Z-T	T	64.3/53.0
C708	4030017460	S.CER C1005 JB 1H 102K-T	T	64.6/55.1
C709	4030017780	S.CER C1005 JB 1H 472K-T	T	60.7/58.7
C710	4030017780	S.CER C1005 JB 1H 472K-T	T	62.3/58.6
C711	4030017460	S.CER C1005 JB 1H 102K-T	T	57.2/50.7
C712	4030017600	S.CER C1005 CH 1H 080C-T	T	52.4/50.3
C714	4030017460	S.CER C1005 JB 1H 102K-T	T	56.2/49.8
C715	4030017780	S.CER C1005 JB 1H 472K-T	T	52.2/53.3
C716	4030017340	S.CER C1005 CH 1H 010B-T	T	55.4/55.2
C717	4030017780	S.CER C1005 JB 1H 472K-T	T	51.2/52.4
C718	4030017780	S.CER C1005 JB 1H 472K-T	T	57.0/55.2
C719	4030017340	S.CER C1005 CH 1H 010B-T	T	61.2/53.9
C720	4030017380	S.CER C1005 CH 1H 050B-T	T	59.4/42.1
C721	4030017780	S.CER C1005 JB 1H 472K-T	T	51.2/49.7
C801	4030017330	S.CER C1005 JF 1C 104Z-T	T	71.5/64.1
C803	4030017780	S.CER C1005 JB 1H 472K-T	T	65.3/61.8
C804	4030017330	S.CER C1005 JF 1C 104Z-T	T	92.0/58.1
C805	4030017460	S.CER C1005 JB 1H 102K-T	T	83.5/55.8
C807	4030017330	S.CER C1005 JF 1C 104Z-T	T	60.6/66.7
C808	4030017870	S.CER C1608 CH 1H 681J-T	T	60.4/65.5
C809	4030018630	S.CER C2012 CH 1H 472J-T	T	57.5/66.8
C810	4030017700	S.CER C1005 CH 1H 151J-T	T	63.9/68.5
C811	4030017700	S.CER C1005 CH 1H 151J-T	T	63.9/69.4
C812	4030017700	S.CER C1005 CH 1H 151J-T	T	60.1/69.4
C813	4030017700	S.CER C1005 CH 1H 151J-T	T	60.1/68.5
C814	4030017330	S.CER C1005 JF 1C 104Z-T	T	88.6/57.2
C815	4030017460	S.CER C1005 JB 1H 102K-T	T	86.7/60.6
C816	4030017400	S.CER C1005 CH 1H 220J-T	T	85.8/59.7
C817	4030017400	S.CER C1005 CH 1H 220J-T	T	84.1/61.8
C818	4030018590	S.CER C1608 CH 1H 122J-T	T	54.6/65.7
C819	4030017850	S.CER C2012 CH 1H 272J-T	T	51.7/65.9
C901	4030017330	S.CER C1005 JF 1C 104Z-T	T	38.4/71.3
C910	4030017710	S.CER C1005 CH 1H 181J-T	T	39.3/65.7
C911	4030017700	S.CER C1005 CH 1H 151J-T	T	48.0/74.8
C913	4030017330	S.CER C1005 JF 1C 104Z-T	T	38.3/61.1
C914	4030017330	S.CER C1005 JF 1C 104Z-T	T	39.3/63.6
C916	4030017330	S.CER C1005 JF 1C 104Z-T	T	34.0/62.0
C917	4030017780	S.CER C1005 JB 1H 472K-T	T	35.7/63.3
C918	4030017330	S.CER C1005 JF 1C 104Z-T	T	34.3/67.5
C920	4030017460	S.CER C1005 JB 1H 102K-T	T	38.4/74.2
C921	4030017330	S.CER C1005 JF 1C 104Z-T	T	34.3/70.2
C922	4030017330	S.CER C1005 JF 1C 104Z-T	T	29.4/73.1
C923	4030017330	S.CER C1005 JF 1C 104Z-T	T	29.9/72.2
C924	4030017780	S.CER C1005 JB 1H 472K-T	T	41.2/74.2
C925	4030017700	S.CER C1005 CH 1H 151J-T	B	31.5/73.0
C1001	4030017780	S.CER C1005 JB 1H 472K-T	T	31.8/71.2
C1009	4030017780	S.CER C1005 JB 1H 472K-T	T	25.9/72.0
C1016	4030017330	S.CER C1005 JF 1C 104Z-T	T	25.9/73.8
C1018	4030017460	S.CER C1005 JB 1H 102K-T	T	20.3/76.0
C1019	4030017330	S.CER C1005 JF 1C 104Z-T	T	15.3/75.8
C1020	4030017330	S.CER C1005 JF 1C 104Z-T	T	12.7/75.8
C1021	4030017330	S.CER C1005 JF 1C 104Z-T	T	4.6/79.0
C1022	4510008630	S.ELE 16 CE 47 FE	B	6.1/86.0
C1023	4510008630	S.ELE 16 CE 47 FE	B	5.7/77.4
C1101	4030017490	S.CER C1608 JB 1A 105K-T	T	2.5/79.0
C1102	4030017330	S.CER C1005 JF 1C 104Z-T	T	4.6/78.1
C1104	4030017490	S.CER C1608 JB 1A 105K-T	T	2.5/87.8
C1105	4030018960	S.CER C3216 JB 1C 106MT-N	T	3.0/89.7
C1108	4030017330	S.CER C1005 JF 1C 104Z-T	T	2.4/91.3
C1201	4030017330	S.CER C1005 JF 1C 104Z-T	T	26.7/80.6
C1202	4030017330	S.CER C1005 JF 1C 104Z-T	T	28.7/80.5
C1203	4030017330	S.CER C1005 JF 1C 104Z-T	T	18.6/79.2
C1204	4030018960	S.CER C3216 JB 1C 106MT-N	T	9.1/77.0
C1206	4030017780	S.CER C1005 JB 1H 472K-T	T	14.3/79.4
C1207	4030017780	S.CER C1005 JB 1H 472K-T	T	12.7/78.5
C1208	4030018080	S.CER C1005 JB 1H 182K-T	T	13.0/85.0
C1209	4030018820	S.CER C1005 JB 1H 561K-T	T	13.0/84.1

Eqv.= This component is equivalent to the REF No. component listed above, and may be substituted on parts orders and repairs.

[MAIN UNIT]

REF NO.	PARTS NO.	DESCRIPTION	M.	H/V LOCATION
C1210	4030017780	S.CER C1005 JB 1H 472K-T	T	11.4/84.1
C1211	4030017490	S.CER C1608 JB 1A 105K-T	T	9.2/84.5
C1212	4030017490	S.CER C1608 JB 1A 105K-T	T	6.8/87.8
C1213	4030017330	S.CER C1005 JF 1C 104Z-T	T	21.9/78.3
C1301	4030017330	S.CER C1005 JF 1C 104Z-T	T	15.3/73.6
C1302	4030017330	S.CER C1005 JF 1C 104Z-T	T	15.1/67.4
C1303	4030018860	S.CER C1005 JB 0J 105K-T	T	11.4/67.4
C1304	4030017330	S.CER C1005 JF 1C 104Z-T	T	14.4/69.2
C1305	4030017330	S.CER C1005 JF 1C 104Z-T	T	11.6/65.6
C1306	4030017330	S.CER C1005 JF 1C 104Z-T	T	10.9/60.3
C1307	4030017330	S.CER C1005 JF 1C 104Z-T	T	16.2/65.6
C1308	4030017330	S.CER C1005 JF 1C 104Z-T	T	14.5/60.3
C1309	4030017330	S.CER C1005 JF 1C 104Z-T	T	3.8/50.8
C1310	4030017330	S.CER C1005 JF 1C 104Z-T	T	16.2/62.9
C1311	4030018960	S.CER C3216 JB 1C 106MT-N	T	5.4/58.5
C1312	4030018860	S.CER C1005 JB 0J 105K-T	T	13.0/66.5
C1401	4030017330	S.CER C1005 JF 1C 104Z-T	B	46.6/77.4
C1402	4030017700	S.CER C1005 CH 1H 151J-T	B	42.0/69.7
C1403	4030017650	S.CER C1005 CH 1H 472J-T	B	45.5/71.5
C1404	4030017700	S.CER C1005 CH 1H 151J-T	B	42.0/70.6
C1405	4030017780	S.CER C1005 JB 1H 472K-T	B	43.7/71.5
C1406	4030017780	S.CER C1005 JB 1H 472K-T	B	42.0/72.4
C1407	4030017780	S.CER C1005 JB 1H 472K-T	B	44.7/74.4
C1408	4030017780	S.CER C1005 JB 1H 472K-T	B	40.4/79.1
C1409	4030017780	S.CER C1005 JB 1H 472K-T	B	34.7/79.1
C1411	4030018860	S.CER C1005 JB 0J 105K-T	B	27.0/80.0
C1412	4030016950	S.CER C1005 JB 1A 473K-T	B	27.1/80.9
C1413	4030017490	S.CER C1608 JB 1A 105K-T	B	20.7/77.5
C1414	4030016950	S.CER C1005 JB 1A 473K-T	B	25.1/77.8
C1415	4510008630	S.ELE 6 CE 100 FE	B	13.2/81.2
C1416	4030016950	S.CER C1005 JB 1A 473K-T	B	20.2/78.5
C1418	4030017350	S.CER C1005 CH 1H 020B-T	B	23.1/86.6
C1419	4030018390	S.CER C1005 JB 1A 563K-T	B	23.1/87.5
C1420	4030017420	S.CER C1005 CH 1H 470J-T	B	17.9/83.1
C1421	4030018960	S.CER C3216 JB 1C 106MT-N	B	19.8/87.3
C1422	4030017640	S.CER C1005 CH 1H 150J-T	B	17.9/82.2
C1423	4610001970	S.TRI TZC3P200A110R00 (TZC03P200A1102)	T	3.9/72.6
C1491	4030017670	S.CER C1005 CH 1H 390J-T	[EUR] B	88.2/29.4
	4030017670	S.CER C1005 CH 1H 390J-T	[FRA]	
	4030017670	S.CER C1005 CH 1H 390J-T	[ESP]	
	4030017400	S.CER C1005 CH 1H 220J-T	[USA]	
	4030017670	S.CER C1005 CH 1H 390J-T	[ITR]	
	4030017670	S.CER C1005 CH 1H 390J-T	[UK]	
	4030017400	S.CER C1005 CH 1H 220J-T	[KOR]	
	4030017670	S.CER C1005 CH 1H 390J-T	[AUS]	
	4030017670	S.CER C1005 CH 1H 390J-T	[CHN]	
C1493	4030017670	S.CER C1005 CH 1H 390J-T	B	86.1/33.8
C1494	4030017670	S.CER C1005 CH 1H 390J-T	[EUR] B	83.7/34.0
	4030017670	S.CER C1005 CH 1H 390J-T	[FRA]	
	4030017670	S.CER C1005 CH 1H 390J-T	[ESP]	
	4030017420	S.CER C1005 CH 1H 470J-T	[USA]	
	4030017670	S.CER C1005 CH 1H 390J-T	[ITR]	
	4030017670	S.CER C1005 CH 1H 390J-T	[UK]	
	4030017670	S.CER C1005 CH 1H 390J-T	[KOR]	
	4030017670	S.CER C1005 CH 1H 390J-T	[AUS]	
	4030017670	S.CER C1005 CH 1H 390J-T	[CHN]	
C1495	4030011280	S.CER C1608 CH 1H 271J-T	B	84.0/33.0
	4030011280	S.CER C1608 CH 1H 271J-T	[FRA]	
	4030011280	S.CER C1608 CH 1H 271J-T	[ESP]	
	4030010760	S.CER C1608 CH 1H 331J-T	[USA]	
	4030011280	S.CER C1608 CH 1H 271J-T	[ITR]	
	4030011280	S.CER C1608 CH 1H 271J-T	[UK]	
	4030010760	S.CER C1608 CH 1H 331J-T	[KOR]	
	4030011280	S.CER C1608 CH 1H 271J-T	[AUS]	
	4030011280	S.CER C1608 CH 1H 271J-T	[CHN]	
C1496	4030011260	S.CER C1005 CH 1H 330J-T	B	79.3/35.3
C1498	4030017670	S.CER C1005 CH 1H 390J-T	[EUR] B	79.4/36.2
	4030017670	S.CER C1005 CH 1H 390J-T	[FRA]	
	4030017670	S.CER C1005 CH 1H 390J-T	[ESP]	
	4030017400	S.CER C1005 CH 1H 220J-T	[USA]	
	4030017670	S.CER C1005 CH 1H 390J-T	[ITR]	
	4030017670	S.CER C1005 CH 1H 390J-T	[UK]	
	4030017400	S.CER C1005 CH 1H 220J-T	[KOR]	
	4030017670			

[MAIN UNIT]

REF NO.	PARTS NO.	DESCRIPTION	M.	H/V LOCATION
C1524	4030017420	S.CER C1005 CH 1H 470J-T	[EUR]	B 73.7/60.6
	4030017420	S.CER C1005 CH 1H 470J-T	[FRA]	
	4030017420	S.CER C1005 CH 1H 470J-T	[ESP]	
	4030017510	S.CER C1005 CH 1H 680J-T	[USA]	
	4030017420	S.CER C1005 CH 1H 470J-T	[ITR]	
	4030017420	S.CER C1005 CH 1H 470J-T	[UK]	
	4030017510	S.CER C1005 CH 1H 680J-T	[KOR]	
	4030017420	S.CER C1005 CH 1H 470J-T	[AUS]	
	4030017420	S.CER C1005 CH 1H 470J-T	[CHN]	
C1525	4030018900	S.CER C1005 JB 0J 474K-T	B	85.9/60.0
C1526	4030018960	S.CER C3216 JB 1C 106MT-N	B	69.3/51.6
C1531	4030017490	S.CER C1608 JB 1A 105K-T	B	83.3/51.6
C1532	4030017780	S.CER C1005 JB 1H 472K-T	B	81.9/41.3
C1533	4030017780	S.CER C1005 JB 1H 472K-T	B	81.9/39.5
C1534	4030017780	S.CER C1005 JB 1H 472K-T	B	83.6/38.5
C1601	4030017780	S.CER C1005 JB 1H 472K-T	T	6.3/52.3
C1604	4030017780	S.CER C1005 JB 1H 472K-T	T	5.6/50.8
C1605	4030017330	S.CER C1005 JF 1C 104Z-T	T	8.8/48.7
C1607	4030017780	S.CER C1005 JB 1H 472K-T	T	14.8/46.0
C1609	4030017490	S.CER C1608 JB 1A 105K-T	T	14.1/33.7
C1610	4030017330	S.CER C1005 JF 1C 104Z-T	T	12.1/44.8
C1611	4030017330	S.CER C1005 JF 1C 104Z-T	T	14.6/41.1
C1613	4030017330	S.CER C1005 JF 1C 104Z-T	T	19.0/47.1
C1614	4030017730	S.CER C1005 JB 1H 471K-T	T	15.1/36.2
C1615	4030017420	S.CER C1005 CH 1H 470J-T	T	10.4/46.9
C1616	4550007260	S.TAN F931C475MAABMA	T	9.7/50.6
C1618	4030017430	S.CER C1005 CH 1H 101J-T	T	12.7/26.3
C1701	4030017490	S.CER C1608 JB 1A 105K-T	B	55.1/50.5
C1702	4030017490	S.CER C1608 JB 1A 105K-T	B	55.0/69.7
C1801	4030017330	S.CER C1005 JF 1C 104Z-T	B	18.4/105.0
C1802	4510008630	S.ELE 16 CE 47 FE	B	14.5/101.3
C1803	4030018960	S.CER C3216 JB 1C 106MT-N	B	22.3/112.2
C1804	4030017330	S.CER C1005 JF 1C 104Z-T	B	22.9/110.6
C1901	4030017330	S.CER C1005 JF 1C 104Z-T	T	36.2/80.4
C1902	4030017330	S.CER C1005 JF 1C 104Z-T	T	33.7/80.4
C1903	4030017330	S.CER C1005 JF 1C 104Z-T	B	23.3/18.9
C1904	4030017330	S.CER C1005 JF 1C 104Z-T	B	32.5/89.9
C1905	4030017330	S.CER C1005 JF 1C 104Z-T	B	26.0/33.8
C1906	4030017330	S.CER C1005 JF 1C 104Z-T	B	26.0/32.9
C1907	4030017330	S.CER C1005 JF 1C 104Z-T	T	41.7/80.4
C1908	4030017330	S.CER C1005 JF 1C 104Z-T	T	38.5/80.7
C1909	4030017330	S.CER C1005 JF 1C 104Z-T	B	21.7/14.0
C1910	4030017460	S.CER C1005 JB 1H 102K-T	B	45.4/25.5
C1916	4030018960	S.CER C3216 JB 1C 106MT-N	B	14.8/50.6
C1917	4030018960	S.CER C3216 JB 1C 106MT-N	B	5.4/52.8
C1951	4030018960	S.CER C3216 JB 1C 106MT-N	B	48.1/103.1
C1952	4030018960	S.CER C3216 JB 1C 106MT-N	B	48.1/98.9
C1953	4030018960	S.CER C3216 JB 1C 106MT-N	B	48.1/96.8
C1954	4030018960	S.CER C3216 JB 1C 106MT-N	B	48.7/105.2
C1955	4030018960	S.CER C3216 JB 1C 106MT-N	B	48.1/101.0
C1956	4030018960	S.CER C3216 JB 1C 106MT-N	B	60.9/118.7
C1957	4030017330	S.CER C1005 JF 1C 104Z-T	B	63.8/116.7
C1958	4030018910	S.CER C1608 JB 0J 475K-T	B	20.9/125.7
C1959	4550008160	S.TAN F931A226MAA	[EUR]	B 11.7/120.2
	Eqv. 4550007090	S.TAN TEESVA 1A 226M8R	[EUR]	
	Eqv. 4550007090	S.TAN TEESVA 1A 226M8R	[FRA]	
	Eqv. 4550008160	S.TAN F931A226MAA	[FRA]	
C1959	4550007090	S.TAN TEESVA 1A 226M8R	[ESP]	B 11.7/120.2
	Eqv. 4550008160	S.TAN F931A226MAA	[ESP]	
C1959	4550008160	S.TAN F931A226MAA	[USA]	B 11.7/120.2
	Eqv. 4550007090	S.TAN TEESVA 1A 226M8R	[USA]	
C1959	4550007090	S.TAN TEESVA 1A 226M8R	[ITR]	B 11.7/120.2
	Eqv. 4550008160	S.TAN F931A226MAA	[ITR]	
C1959	4550008160	S.TAN F931A226MAA	[UK]	B 11.7/120.2
	Eqv. 4550007090	S.TAN TEESVA 1A 226M8R	[UK]	
C1959	4550007090	S.TAN TEESVA 1A 226M8R	[KOR]	B 11.7/120.2
	Eqv. 4550008160	S.TAN F931A226MAA	[KOR]	
C1959	4550007090	S.TAN TEESVA 1A 226M8R	[AUS]	B 11.7/120.2
	Eqv. 4550008160	S.TAN F931A226MAA	[AUS]	
C1959	4550008160	S.TAN F931A226MAA	[CHN]	B 11.7/120.2
	Eqv. 4550007090	S.TAN TEESVA 1A 226M8R	[CHN]	
C1960	4030010210	S.CER C3216 JB 1C 105M-T	B	47.3/109.8
C1961	4030017730	S.CER C1005 JB 1H 471K-T	B	44.1/110.1
C1962	4030017440	S.CER C1005 CH 1H 221J-T	B	44.7/108.4
C1963	4030017500	S.CER C1005 CH 1H 560J-T	B	35.3/105.2
C1964	4030017330	S.CER C1005 JF 1C 104Z-T	B	44.3/111.4
C1965	4030018960	S.CER C3216 JB 1C 106MT-N	B	7.5/108.1
C1966	4030017330	S.CER C1005 JF 1C 104Z-T	B	10.2/103.1
C1968	4030018960	S.CER C3216 JB 1C 106MT-N	B	31.8/103.6
C1969	4030018970	S.CER C3225 JB 1C 226MT-N	B	30.9/101.0
C1970	4030018970	S.CER C3225 JB 1C 226MT-N	B	30.9/98.0
C1971	4030017330	S.CER C1005 JF 1C 104Z-T	B	45.9/111.4
C1972	4030017330	S.CER C1005 JF 1C 104Z-T	B	47.6/106.8
C1973	4030017330	S.CER C1005 JF 1C 104Z-T	B	32.1/105.2
C2001	4030017780	S.CER C1005 JB 1H 472K-T	T	33.3/10.4
C2002	4030017330	S.CER C1005 JF 1C 104Z-T	B	71.7/14.7
C2003	4030017780	S.CER C1005 JB 1H 472K-T	B	58.8/15.8
C2004	4030017780	S.CER C1005 JB 1H 472K-T	B	83.1/6.0
C2005	4030017780	S.CER C1005 JB 1H 472K-T	B	69.1/16.5
C2006	4030017330	S.CER C1005 JF 1C 104Z-T	B	83.1/6.9
C2007	4030017780	S.CER C1005 JB 1H 472K-T	B	84.7/6.0
C2008	4030017330	S.CER C1005 JF 1C 104Z-T	B	56.7/10.1
C2009	4030017330	S.CER C1005 JF 1C 104Z-T	B	75.4/18.7
C2010	4030017780	S.CER C1005 JB 1H 472K-T	B	75.7/6.7
C2011	4030017330	S.CER C1005 JF 1C 104Z-T	B	75.1/7.7
C2012	4030017780	S.CER C1005 JB 1H 472K-T	B	63.1/15.5
C2013	4030017330	S.CER C1005 JF 1C 104Z-T	B	89.0/2.0
C2014	4030017780	S.CER C1005 JB 1H 472K-T	B	32.5/11.9
C2015	4030017780	S.CER C1005 JB 1H 472K-T	B	32.5/12.8
C2016	4030017780	S.CER C1005 JB 1H 472K-T	B	19.1/131.2
C2017	4030017330	S.CER C1005 JF 1C 104Z-T	T	86.4/10.2
C2018	4030017780	S.CER C1005 JB 1H 472K-T	B	42.7/17.7
C2019	4030017780	S.CER C1005 JB 1H 472K-T	T	24.8/126.8
C2020	4030017330	S.CER C1005 JF 1C 104Z-T	B	84.2/23.1
C2021	4030017780	S.CER C1005 JB 1H 472K-T	B	32.5/16.1

Eqv.= This component is equivalent to the REF No. component listed above, and may be substituted on parts orders and repairs.

[MAIN UNIT]

REF NO.	PARTS NO.	DESCRIPTION	M.	H/V LOCATION
C2022	4030017780	S.CER C1005 JB 1H 472K-T	B	30.3/130.3
C2024	4030017780	S.CER C1005 JB 1H 472K-T	B	28.8/128.3
C2025	4030017780	S.CER C1005 JB 1H 472K-T	B	45.0/12.6
C2026	4030018960	S.CER C3216 JB 1C 106MT-N	B	10.2/23.5
C2027	4030018960	S.CER C3216 JB 1C 106MT-N	B	10.2/14.7
C2028	4030017330	S.CER C1005 JF 1C 104Z-T	B	51.8/12.7
C2029	4030017330	S.CER C1005 JF 1C 104Z-T	B	58.1/9.4
C2030	4030017330	S.CER C1005 JF 1C 104Z-T	B	55.9/15.8
C2032	4030017780	S.CER C1005 JB 1H 472K-T	B	27.4/129.0
C2033	4030017330	S.CER C1005 JF 1C 104Z-T	B	71.1/21.9
C2034	4030017780	S.CER C1005 JB 1H 472K-T	B	64.9/5.6
C2035	4030017780	S.CER C1005 JB 1H 472K-T	B	25.7/130.2
C2036	4030017330	S.CER C1005 JF 1C 104Z-T	B	88.2/8.0
C2037	4030017330	S.CER C1005 JF 1C 104Z-T	B	76.4/16.5
C2038	4030017780	S.CER C1005 JB 1H 472K-T	T	14.5/126.5
C2039	4030017780	S.CER C1005 JB 1H 472K-T	B	80.2/6.8
C2040	4030017780	S.CER C1005 JB 1H 472K-T	B	64.6/17.7
C2041	4030017330	S.CER C1005 JF 1C 104Z-T	B	75.2/10.5
C2042	4030017330	S.CER C1005 JF 1C 104Z-T	B	62.8/18.2
C2043	4030017780	S.CER C1005 JB 1H 472K-T	B	55.4/8.9
C2044	4030017780	S.CER C1005 JB 1H 472K-T	B	62.8/19.5
C2045	4030017780	S.CER C1005 JB 1H 472K-T	B	64.4/21.9
C2046	4030017780	S.CER C1005 JB 1H 472K-T	B	63.7/14.6
C2047	4030017780	S.CER C1005 JB 1H 472K-T	B	57.8/12.0
C2048	4030017780	S.CER C1005 JB 1H 472K-T	B	63.2/5.6
C2049	4030017780	S.CER C1005 JB 1H 472K-T	T	45.1/101.9
C2050	4030017780	S.CER C1005 JB 1H 472K-T	T	42.9/100.3
C2051	4030017330	S.CER C1005 JF 1C 104Z-T	T	56.3/100.0
C2052	4030017780	S.CER C1005 JB 1H 472K-T	T	21.6/108.1
C2053	4030017780	S.CER C1005 JB 1H 472K-T	T	49.9/107.6
C2054	4030018960	S.CER C3216 JB 1C 106MT-N	B	55.4/83.4
C2055	4030018960	S.CER C3216 JB 1C 106MT-N	B	28.2/88.6
C2058	4030018960	S.CER C3216 JB 1C 106MT-N	B	16.4/95.6
C2062	4550008170	S.TAN F931A476MBA	[EUR]	B 26.6/13.0
	Eqv. 4550007710	S.TAN TEESVB2 1A 476M8R	[EUR]	
C2062	4550007710	S.TAN TEESVB2 1A 476M8R	[FRA]	B 26.6/13.0
	Eqv. 4550008170	S.TAN F931A476MBA	[FRA]	
C2062	4550007710	S.TAN TEESVB2 1A 476M8R	[ESP]	B 26.6/13.0
	Eqv. 4550008170	S.TAN F931A476MBA	[ESP]	
C2062	4550008170	S.TAN F931A476MBA	[USA]	B 26.6/13.0
	Eqv. 4550007710	S.TAN TEESVB2 1A 476M8R	[USA]	
C2062	4550007710	S.TAN TEESVB2 1A 476M8R	[ITR]	B 26.6/13.0
	Eqv. 4550008170	S.TAN F931A476MBA	[ITR]	
C2062	4550008170	S.TAN F931A476MBA	[UK]	B 26.6/13.0
	Eqv. 4550007710	S.TAN TEESVB2 1A 476M8R	[UK]	
C2062	4550007710	S.TAN TEESVB2 1A 476M8R	[KOR]	B 26.6/13.0
	Eqv. 4550008170	S.TAN F931A476MBA	[KOR]	
C2062	4550007710	S.TAN TEESVB2 1A 476M8R	[AUS]	B 26.6/13.0
	Eqv. 4550008170	S.TAN F931A476MBA	[AUS]	
C2062	4550008170	S.TAN F931A476MBA	[CHN]	B 26.6/13.0
	Eqv. 4550007710	S.TAN TEESVB2 1A 476M8R	[CHN]	
C2063	4030017730	S.CER C1005 JB 1H 471K-T	B	46.1/13.8
C2064	4030018960	S.CER C3216 JB 1C 106MT-N	B	61.1/23.1
C2065	4030016930	S.CER C1005 JB 1A 104K-T	B	73.4/1.3
C2066	4030016930	S.CER C1005 JB 1A 104K-T	B	75.1/1.3

[MAIN UNIT]

REF NO.	PARTS NO.	DESCRIPTION	M.	H/V LOCATION
C2233	4030017780	S.CER C1005 JB 1H 472K-T	T	4.7/123.3
C2234	4550007310	S.TAN F930J227MNMBA	T	70.1/130.6
C2235	4030018960	S.CER C3216 JB 1C 106MT-N	T	41.0/108.8
C2236	4030018960	S.CER C3216 JB 1C 106MT-N	T	39.9/111.2
C2237	4030017460	S.CER C1005 JB 1H 102K-T	T	60.6/123.4
C2254	4030017330	S.CER C1005 JF 1C 104Z-T	T	7.7/92.5
C2255	4030017330	S.CER C1005 JF 1C 104Z-T	B	2.5/98.2
C2256	4030017330	S.CER C1005 JF 1C 104Z-T	B	2.6/95.7
C2257	4030017330	S.CER C1005 JF 1C 104Z-T	T	9.9/88.0
C2260	4030017330	S.CER C1005 JF 1C 104Z-T	T	18.6/103.7
C2261	4030017330	S.CER C1005 JF 1C 104Z-T	T	6.7/104.4
C2262	4030017330	S.CER C1005 JF 1C 104Z-T	T	58.5/100.4
C2264	4030017330	S.CER C1005 JF 1C 104Z-T	T	61.9/88.9
C2266	4030017330	S.CER C1005 JF 1C 104Z-T	T	72.0/85.3
C2268	4030017330	S.CER C1005 JF 1C 104Z-T	T	68.6/89.5
C2269	4030017330	S.CER C1005 JF 1C 104Z-T	B	78.5/92.4
C2270	4030017780	S.CER C1005 JB 1H 472K-T	T	61.9/89.8
C2272	4030017330	S.CER C1005 JF 1C 104Z-T	T	56.3/92.3
C2274	4030017330	S.CER C1005 JF 1C 104Z-T	T	55.8/95.0
C2275	4030017330	S.CER C1005 JF 1C 104Z-T	B	68.2/99.3
C2276	4030017330	S.CER C1005 JF 1C 104Z-T	B	64.2/100.6
C2277	4030017330	S.CER C1005 JF 1C 104Z-T	T	63.6/103.5
C2278	4030017330	S.CER C1005 JF 1C 104Z-T	T	63.7/108.0
C2279	4030017330	S.CER C1005 JF 1C 104Z-T	T	62.8/108.9
C2280	4030017420	S.CER C1005 CH 1H 470J-T	T	51.8/37.9
C2281	4030017330	S.CER C1005 JF 1C 104Z-T	T	68.6/90.4
C2282	4030017330	S.CER C1005 JF 1C 104Z-T	B	80.5/93.1
C2283	4030017330	S.CER C1005 JF 1C 104Z-T	B	81.7/92.2
C2285	4030017330	S.CER C1005 JF 1C 104Z-T	T	50.8/99.1
C2286	4030017330	S.CER C1005 JF 1C 104Z-T	T	14.2/88.9
C2301	4030018910	S.CER C1608 JB 0J 475K-T	T	30.8/106.9
C2302	4030018910	S.CER C1608 JB 0J 475K-T	T	27.9/109.5
C2303	4550007310	S.TAN F930J227MNMBA	T	84.4/110.4
C2311	4030017330	S.CER C1005 JF 1C 104Z-T	B	68.1/110.3
C2312	4030018910	S.CER C1608 JB 0J 475K-T	B	67.4/105.0
C2401	4030017330	S.CER C1005 JF 1C 104Z-T	B	90.8/103.8
C2402	4030017330	S.CER C1005 JF 1C 104Z-T	B	81.2/100.7
C2403	4030017780	S.CER C1005 JB 1H 472K-T	B	77.2/28.8
C2405	4030017330	S.CER C1005 JF 1C 104Z-T	T	74.3/79.3
C2406	4030017460	S.CER C1005 JB 1H 102K-T	B	88.5/99.8
C2407	4030017330	S.CER C1005 JF 1C 104Z-T	T	74.1/78.2
C2408	4030017330	S.CER C1005 JF 1C 104Z-T	B	84.9/96.2
C2409	4030017330	S.CER C1005 JF 1C 104Z-T	T	75.6/77.6
C2410	4030017330	S.CER C1005 JF 1C 104Z-T	B	88.5/85.8
C2411	4030017330	S.CER C1005 JF 1C 104Z-T	B	81.1/96.5
C2412	4510008630	S.ELE 16 CE 47 FE	B	62.1/30.4
C2413	4030017330	S.CER C1005 JF 1C 104Z-T	B	88.5/93.7
C2414	4030017780	S.CER C1005 JB 1H 472K-T	T	84.0/95.6
C2415	4030017780	S.CER C1005 JB 1H 472K-T	B	88.4/28.1
C2417	4030017330	S.CER C1005 JF 1C 104Z-T	B	88.4/27.2
C2418	4030017330	S.CER C1005 JF 1C 104Z-T	B	82.6/94.1
C2419	4030017330	S.CER C1005 JF 1C 104Z-T	B	88.5/86.7
C2422	4030017330	S.CER C1005 JF 1C 104Z-T	T	84.8/87.3
C2423	4030017420	S.CER C1005 CH 1H 470J-T	B	62.2/141.2
C2424	4510008630	S.ELE 16 CE 47 FE	B	69.2/31.4
C2426	4030017330	S.CER C1005 JF 1C 104Z-T	B	68.8/82.2
C2427	4030012600	S.CER C2012 JB 1A 105M-T	T	85.1/91.4
C2501	4030017330	S.CER C1005 JF 1C 104Z-T	B	8.1/94.3
C2502	4030018960	S.CER C3216 JB 1C 106MT-N	B	11.5/95.2
C2503	4030016970	S.CER C1005 JB 1E 223K-T	B	14.9/89.3
C2505	4030016940	S.CER C1005 JB 1A 393K-T	B	17.4/91.4
C2506	4030017780	S.CER C1005 JB 1H 472K-T	B	18.3/93.8
C2507	4030017490	S.CER C1608 JB 1A 105K-T	B	12.8/89.3
C2551	4030017330	S.CER C1005 JF 1C 104Z-T	B	43.0/124.1
C2552	4030018960	S.CER C3216 JB 1C 106MT-N	B	47.9/118.8
C2553	4030016970	S.CER C1005 JB 1E 223K-T	B	51.4/124.7
C2554	4030018390	S.CER C1005 JB 1A 563K-T	B	53.9/122.0
C2555	4030017760	S.CER C1005 JB 1H 222K-T	B	53.9/121.1
C2556	4030017770	S.CER C1005 JB 1H 332K-T	B	52.9/123.8
C2557	4030017330	S.CER C1005 JF 1C 104Z-T	B	41.8/120.9
C2558	4030018960	S.CER C3216 JB 1C 106MT-N	B	43.0/118.5
C2561	4030018960	S.CER C3216 JB 1C 106MT-N	B	56.5/124.4
C2562	4030018960	S.CER C3216 JB 1C 106MT-N	B	53.4/126.5
C2563	4550007970	S.TAN TMCMC1A107MTRF	B	75.3/122.8
C2564	4030018080	S.CER C1005 JB 1H 182K-T	B	47.8/125.6
C2565	4030017430	S.CER C1005 CH 1H 101J-T	B	44.6/122.6
C2566	4030018090	S.CER C1005 JB 1E 822K-T	B	46.2/124.3
C2601	4030017330	S.CER C1005 JF 1C 104Z-T	B	59.8/125.2
C2603	4030010210	S.CER C3216 JB 1C 105M-T	B	87.6/126.1
C2604	4030016970	S.CER C1005 JB 1E 223K-T	B	89.2/128.6
C2605	4030017330	S.CER C1005 JF 1C 104Z-T	B	83.9/133.7
C2606	4510009250	S.ELE EEEFK1C471P	T	69.2/137.4
C2607	4510008650	S.ELE EEEFK1C221P	T	58.5/138.4
C2608	4030017330	S.CER C1005 JF 1C 104Z-T	B	87.6/128.6
C2610	4510009250	S.ELE EEEFK1C471P	T	6.2/65.3
C2612	4030017330	S.CER C1005 JF 1C 104Z-T	B	34.0/123.9
C2613	4510009250	S.ELE EEEFK1C471P	T	31.8/131.5
C2616	4030017780	S.CER C1005 JB 1H 472K-T	B	31.6/134.3
C2617	4030017780	S.CER C1005 JB 1H 472K-T	T	33.5/126.0
C2618	4030017430	S.CER C1005 CH 1H 101J-T	B	31.6/133.4
C2619	4030017780	S.CER C1005 JB 1H 472K-T	T	67.8/112.7
C2620	4510008630	S.ELE 16 CE 47 FE	B	82.9/119.2
C2621	4510008500	S.ELE EEE1CA101WP	T	49.2/138.4
C2622	4510008500	S.ELE EEE1CA101WP	T	60.2/130.4
C2624	4030017330	S.CER C1005 JF 1C 104Z-T	B	38.5/124.5
CP1601	6910009670	S.CHE HK3-S-T	T	11.8/54.7
J1	6510028210	CON SJ050010 (TMP-J01X-V6)		
J101	6510028210	CON SJ050010 (TMP-J01X-V6)		
J401	6510028210	CON SJ050010 (TMP-J01X-V6)		
J801	6510028210	CON SJ050010 (TMP-J01X-V6)		
J2002	6510019971	S.CON 52808-1071	T	39.0/12.6

Eqv.= This component is equivalent to the REF No. component listed above, and may be substituted on parts orders and repairs.

[MAIN UNIT]

REF NO.	PARTS NO.	DESCRIPTION	M.	H/V LOCATION
J2003	6510024861	S.CON 5406721-2	T	18.7/137.8
J2004	6510023512	S.CON 28FLT-SM2-TB(LF)(SN)(M)	T	82.4/4.9
J2005	6510023512	S.CON 28FLT-SM2-TB(LF)(SN)(M)	T	66.0/4.9
J2231	6510018961	S.CON B2B-PH-SM4-TB(LF)(SN)	T	51.6/129.5
J2251	6510022881	S.CON AXK5S30347YG	T	12.3/96.6
J2252	6510024821	S.CON AXK5S60347YG	T	72.4/101.1
J2401	6510025771	S.CON 03-935H1-72BKA	B	57.7/136.6
J2402	6510025771	S.CON 03-935H1-72BKA	B	47.0/136.6
J2403	6510019371	S.CON B3B-ZR-SM4-TF(LF)(SN)	T	94.8/1.9
J2405	6510024880	S.CON 52689-3087	T	90.3/93.9
J2406	6510024880	S.CON 52689-3087	T	90.3/71.0
J2407	6510025771	S.CON 03-935H1-72BKA	B	68.4/136.6
J2601	6510014961	S.CON B2B-ZR-SM4-TF(LF)(SN)	T	42.7/128.8
J2602	6510025771	S.CON 03-935H1-72BKA	B	36.3/136.6
W1	9029701008	WIR 72/98/020/X98/X98		
W601	9029701008	WIR 72/98/020/X98/X98		
EP511	6910012350	S.BEA MMZ1608Y 102BT	T	44.2/26.5
EP1951	6910014730	S.BEA MPZ2012S331A-T	B	61.4/116.7
EP1952	6910014730	S.BEA MPZ2012S331A-T	B	26.8/113.4
EP1953	6910014730	S.BEA MPZ2012S331A-T	B	10.0/104.5
EP1954	6910014730	S.BEA MPZ2012S331A-T	B	50.4/107.3
EP2001	6910012350	S.BEA MMZ1608Y 102BT	B	74.2/5.3
EP2002	6910012350	S.BEA MMZ1608Y 102BT	B	34.7/12.6
EP2003	6910012350	S.BEA MMZ1608Y 102BT	B	33.5/13.8
EP2004	6910012350	S.BEA MMZ1608Y 102BT	B	39.6/15.9
EP2006	6910014730	S.BEA MPZ2012S331A-T	B	42.2/13.4
EP2007	6910012350	S.BEA MMZ1608Y 102BT	B	45.2/11.1
EP2008	6910012350	S.BEA MMZ1608Y 102BT	B	45.2/14.8
EP2231	6910012350	S.BEA MMZ1608Y 102BT	T	59.9/125.8
EP2251	6910012350	S.BEA MMZ1608Y 102BT	T	4.6/95.5
EP2252	6910012350	S.BEA MMZ1608Y 102BT	T	7.5/95.8
EP2253	6910012350	S.BEA MMZ1608Y 102BT	T	66.1/109.3
EP2254	6910012350	S.BEA MMZ1608Y 102BT	T	65.8/108.1
EP2255	6910012350	S.BEA MMZ1608Y 102BT	T	17.9/101.5
EP2256	6910012350	S.BEA MMZ1608Y 102BT	T	65.1/106.0
EP2257	6910012350	S.BEA MMZ1608Y 102BT	T	65.1/104.8
EP2258	6910012350	S.BEA MMZ1608Y 102BT	B	78.0/93.5
EP2259	6910012350	S.BEA MMZ1608Y 102BT	B	68.1/102.6
EP2260	6910012350	S.BEA MMZ1608Y 102BT	B	68.2/101.4
EP2261	6910012350	S.BEA MMZ1608Y 102BT	B	66.1/98.3
EP2262	6910012350	S.BEA MMZ1608Y 102BT	T	69.9/85.6
EP2263	6910014730	S.BEA MPZ2012S331A-T	T	6.5/93.9
EP2264	6910012350	S.BEA MMZ1608Y 102BT	B	69.4/111.3
EP2265	6910012350	S.BEA MMZ1608Y 102BT	B	68.7/98.3
EP2266	6910012350	S.BEA MMZ1608Y 102BT	T	56.3/93.3
EP2271	6910012350	S.BEA MMZ1608Y 102BT	T	74.6/91.1
EP2402	6910012350	S.BEA MMZ1608Y 102BT	B	51.2/129.6
EP2403	6910012350	S.BEA MMZ1608Y 102BT	B	48.5/129.6
EP2404	6910012350	S.BEA MMZ1608Y 102BT	B	68.6/129.4
EP2405	6910012350	S.BEA MMZ1608Y 102BT	B	62.2/134.9
EP2408	6910012350	S.BEA MMZ1608Y 102BT	B	91.3/102.8
EP2409	6910012350	S.BEA MMZ1608Y 102BT	T	85.3/101.2
EP2410	6910012350	S.BEA MMZ1608Y 102BT	T	84.7/98.4
EP2411	6910012350	S.BEA MMZ1608Y 102BT	T	85.2/79.2
EP2412	6910012350	S.BEA MMZ1608Y 102BT	T	82.6/78.5
EP2413	6910012350	S.BEA MMZ1608Y 102BT	B	72.5/129.3
EP2414	6910012350	S.BEA MMZ1608Y 102BT	B	89.4/91.1
EP2415	6910012350	S.BEA MMZ1608Y 102BT	T	85.0/100.0
EP2416	6910012350	S.BEA MMZ1608Y 102BT	T	80.0/77.6
EP2417	6910012350	S.BEA MMZ1608Y 102BT	B	87.2/78.8
EP2602	6910014730	S.BEA MPZ2012S331A-T	T	36.0/125.7
EP2604	6910014730	S.BEA MPZ2012S331A-T	T	31.6/135.7
EP2605	6910014730	S.BEA MPZ2012S331A-T	B	43.0/135.5
EP2606	6910014730	S.BEA MPZ2012S331A-T	T	41.4/133.7

M.=Mounted side (T: Mounted on the Top side, B: Mounted on the Bottom side) S.=Surface mount

[PA UNIT]

REF NO.	PARTS NO.	DESCRIPTION	M.	H/V LOCATION
IC471	1110005630	S.IC UPC3215TB-E3-A	B	67.6/96.4
IC701	1180002010	S.REG BA08FP-E2	B	126.3/41.9
IC960	1110002700	S.IC NJM2904M-TE1-#FMZB	B	41.0/132.1
IC981	1130012720	S.IC CD74HC4094PWR	T	26.2/5.9
Q101	1560001091	S.FET 2SK2854(T2LICOMF)	T	149.2/28.5
Q102	1560001241	S.FET RD01MUS1-T113	T	146.0/40.1
Q301	1560001601	FET RD70HHF1C-102		
Q302	1560001601	FET RD70HHF1C-102		
Q401	1560001611	FET RD60HUF1C-101		
Q402	1590000680	S.TRA DTC114EUA T106	B	87.7/132.8
Q403	1590000680	S.TRA DTC114EUA T106	B	90.1/130.4
Q451	1580000691	S.FET 3SK291(TE85RF)	B	76.8/108.4
Q452	1590003940	S.TRA RN1105(TE85LF)	B	67.5/115.8
Q453	1590003940	S.TRA RN1105(TE85LF)	B	75.1/119.9
Q501	1560001591	FET RD70HVF1C-121		
Q502	1590000680	S.TRA DTC114EUA T106	T	87.7/107.5
Q503	1590000680	S.TRA DTC114EUA T106	T	87.7/110.0
Q551	1580000691	S.FET 3SK291(TE85RF)	T	68.4/108.9
Q552	1590003940	S.TRA RN1105(TE85LF)	T	63.0/110.1
Q700	1590003940	S.TRA RN1105(TE85LF)	B	126.5/25.0
Q741	1590003940	S.TRA RN1105(TE85LF)	B	79.4/9.0
Q742	1520000460	S.TRA 2SB1132 T100 R	B	83.7/8.3
Q980	1590003940	S.TRA RN1105(TE85LF)	T	51.3/84.6
Q981	1590003940	S.TRA RN1105(TE85LF)	T	51.5/13.8
Q982	1590003940	S.TRA RN1105(TE85LF)	T	53.8/97.3
Q983	1590003940	S.TRA RN1105(TE85LF)	T	51.3/57.0
Q984	1590003940	S.TRA RN1105(TE85LF)	T	51.6/97.2
Q985	1590003940	S.TRA RN1105(TE85LF)	T	51.3/27.9
Q986	1590003940	S.TRA RN1105(TE85LF)	T	51.3/71.5
Q987	1590003940	S.TRA RN1105(TE85LF)	T	52.5/41.6
Q988	1590004030	S.TRA KRX204U-RTK/P	T	58.3/90.3
D102	1750000301	S.DIO 1SS302(TE85RF)	T	152.5/19.9
D151	1750000581	S.DIO 1SV307(TPH3F)	T	59.6/56.4
D152	1790001251	S.DIO MA251110GL	T	56.4/58.5
D301	1160000060	S.DIO DAN202U T106	T	105.1/80.8
D302	1160000060	S.DIO DAN202U T106	T	74.9/87.3
D401	1790001241	S.DIO MA257280GL	B	128.0/133.6
D402	1790001241	S.DIO MA257280GL	B	127.5/139.6
D403	1790001241	S.DIO MA257280GL	B	123.5/140.6
D404	1790001241	S.DIO MA257280GL	B	125.6/132.8
D406	1710001061	DIO L407CDB		
D407	1710001061	DIO L407CDB		
D408	1750000511	S.DIO UX9401F-STD/TR <INT>	B	97.7/136.4
D409	1750000511	S.DIO UX9401F-STD/TR <INT>	B	103.6/133.1
D410	1750000511	S.DIO UX9401F-STD/TR <INT>	B	104.8/130.1
D411	1790001251	S.DIO MA251110GL	B	94.2/129.2
D412	1160000070	S.DIO DAN202K T146	B	91.7/127.1
D451	1750000581	S.DIO 1SV307(TPH3F)	B	85.5/116.4
D452	1750000581	S.DIO 1SV307(TPH3F)	B	82.4/116.0
D453	1720000701	S.VAR 1SV305(TPL3F)	T	75.6/117.3
D454	1720000701	S.VAR 1SV305(TPL3F)	T	77.8/116.6
D455	1720000701	S.VAR 1SV305(TPL3F)	B	75.7/99.2
D456	1720000701	S.VAR 1SV305(TPL3F)	B	67.4/104.2
D461	1750000581	S.DIO 1SV307(TPH3F)	B	65.1/93.6
D462	1750000581	S.DIO 1SV307(TPH3F)	T	65.6/94.7
D501	1790000971	S.DIO MA2J7290GL	B	113.7/123.5
D502	1790000971	S.DIO MA2J7290GL	B	116.4/122.8
D503	1790000971	S.DIO MA2J7290GL	B	114.5/129.5
D504	1790000971	S.DIO MA2J7290GL	B	111.0/129.5
D506	1710001061	DIO L407CDB		
D507	1750000511	S.DIO UX9401F-STD/TR <INT>	B	92.7/117.4
D508	1750000511	S.DIO UX9401F-STD/TR <INT>	T	87.0/114.4
D509	1750000511	S.DIO UX9401F-STD/TR <INT>	T	81.9/120.3
D510	1710001061	DIO L407CDB		
D511	1750000581	S.DIO 1SV307(TPH3F)	B	95.4/112.2
D551	1750000581	S.DIO 1SV307(TPH3F)	T	74.0/116.8
D552	1750000581	S.DIO 1SV307(TPH3F)	T	72.3/116.8
D553	1750000610	S.VAR MA2SV0500L	T	67.2/118.6
D554	1750000610	S.VAR MA2SV0500L	T	69.6/117.9
D555	1750000581	S.DIO 1SV307(TPH3F)	T	66.9/116.7
D556	1720000590	S.VAR MA357(TX)	T	71.6/113.3
D557	1750000581	S.DIO 1SV307(TPH3F)	T	68.1/105.0
D558	1720000590	S.VAR MA357(TX)	T	72.2/104.3
D559	1750000610	S.VAR MA2SV0500L	T	69.0/102.7
D560	1750000610	S.VAR MA2SV0500L	T	71.8/101.3
D701	1790000700	DIO DSA3A1		
D702	1790000700	DIO DSA3A1		
D703	1160000070	S.DIO DAN202K T146	B	126.5/21.5
D704	1790001241	S.DIO MA257280GL	B	87.9/114.0
D705	1160000070	S.DIO DAN202K T146	B	137.5/14.3
D706	1790001241	S.DIO MA257280GL	B	86.0/113.1
D801	1750000301	S.DIO 1SS302(TE85RF)	B	42.7/41.8
D820	1750000301	S.DIO 1SS302(TE85RF)	B	54.4/94.6
D840	1750000301	S.DIO 1SS302(TE85RF)	B	43.4/99.8
D860	1750000301	S.DIO 1SS302(TE85RF)	B	43.0/86.0
D880	1750000301	S.DIO 1SS302(TE85RF)	B	43.3/71.7
D900	1750000301	S.DIO 1SS302(TE85RF)	B	43.7/56.9
D920	1750000301	S.DIO 1SS302(TE85RF)	B	43.0/28.1
D940	1750000301	S.DIO 1SS302(TE85RF)	B	41.1/14.3
D961	1790000491	S.DIO HSM88ASTR-E	B	28.2/130.2
D962	1790000491	S.DIO HSM88ASTR-E	B	28.2/133.8
D964	1750000511	S.DIO UX9401F-STD/TR <INT>	B	40.1/43.9
D965	1750000511	S.DIO UX9401F-STD/TR <INT>	B	42.8/48.0
L101	6200005051	S.COI NLV25T-330J	T	151.3/33.6
L102	6200008570	S.COI LQW2BHN6N8D03L	T	152.3/37.3
L103	6180003960	COI AL04 TB 101K <TRIA>		
L104	6180003960	COI AL04 TB 101K <TRIA>		
L105	6200003950	S.COI HF50ACC 322513-T	B	135.7/34.1
L107	6200002631	S.COI NLV25T-R10J	T	141.0/47.9

Eqv.= This component is equivalent to the REF No. component listed above, and may be substituted on parts orders and repairs.

[PA UNIT]

REF NO.	PARTS NO.	DESCRIPTION	M.	H/V LOCATION
L108	6200003031	S.COI NLV32T-R47J	B	138.1/41.8
L151	6200003941	S.COI NLV25T-5R6J	B	64.2/41.0
L152	6200005521	S.COI NLV25T-470J	B	64.8/38.1
L201	6140004580	S.COI LR-515	T	150.4/52.5
L203	6200010040	S.COI AS100340-10N	T	113.8/79.5
L204	6200010040	S.COI AS100340-10N	T	123.5/69.7
L301	6140003410	COI LR-383		
L302	2040000490	COI EXC-ELDR25C		
L303	6140003590	COI LR-400 (TR10X5X5 6H3)		
L304	6140004570	COI LR-507		
L305	6140004560	COI LR-506		
L306	6110001730	COI LA-262		
L404	6200010060	S.COI AS080647-56N	T	141.1/109.0
L407	6200010170	S.COI AS080447-33N	T	146.6/110.8
L408	2040000490	COI EXC-ELDR25C		
L409	2040000490	COI EXC-ELDR25C		
L410	6200010040	S.COI AS100340-10N	T	126.6/137.8
L411	6200010420	S.COI FHW1210HC 1R0JGT <JJE>	T	118.3/136.7
L412	6200010160	S.COI AS080440-22N	T	104.5/134.4
L413	6200010150	S.COI AS080340-15N	T	88.3/139.6
L414	6200010150	S.COI AS080340-15N	T	81.0/133.6
L415	6200012960	S.COI 0.45-1.4-4TL 12.1N <COMO>	T	99.2/134.0
L416	6200013000	S.COI 0.25-1.9-13TL 135N <COMO>	T	93.8/132.1
L417	6200007790	S.COI LQW2BHN15N03L	B	98.3/131.1
L441	6200010040	S.COI AS100340-10N	T	133.4/137.8
L451	6200005621	S.COI ELJRE 4N7ZFA	B	81.5/120.1
L452	6200012660	S.COI 0.30-1.0-4TR 9.1N <COMO>	T	76.7/114.9
L453	6200007230	S.COI LQW2BHN15N03L	B	74.1/104.1
L454	6200007230	S.COI LQW2BHN15N03L	B	70.0/102.4
L501	6200010780	S.COI C2520C-1R0G-A	T	117.1/86.6
L502	6200010600	S.COI AS080647-56N	T	118.1/125.0
L504	6200010780	S.COI C2520C-1R0G-A	T	105.8/123.5
L505	6200010070	S.COI AS080747-68N	T	90.2/118.6
L506	6200010170	S.COI AS080447-33N	T	92.0/124.3
L507	6200012910	S.COI 0.35-1.6-8TL 45.5N <COMO>	T	84.7/118.0
L508	6200010050	S.COI AS080547-47N	T	81.9/127.7
L509	6200010780	S.COI C2520C-1R0G-A	T	93.2/113.2
L510	6200010050	S.COI AS080547-47N	T	75.5/127.5
L531	6110003980	COI LA-604		
L541	6200010070	S.COI AS080747-68N	T	128.6/129.9
L551	6200007700	S.COI LQW2BHN22N03L	T	76.1/120.8
L552	6200007720	S.COI LQW2BHN33N03L	T	70.9/121.3
L553	6200008090	S.COI LQW2BHN68N03L	T	65.2/121.7
L554	6200003640	S.COI MLF1608E 100K-T	T	64.9/114.8
L555	6200003711	S.COI NLV25T-2R7J	T	65.2/105.4
L556	6200003640	S.COI MLF1608E 100K-T	B	65.0/109.6
L557	6200007760	S.COI LQW2BHN82N03L	T	66.8/100.5
L558	6200007710	S.COI LQW2BHN27N03L	T	69.9/98.4
L560	6200002611	S.COI NLV25T-R47J	T	62.9/97.3
L601	6200010040	S.COI AS100340-10N	T	69.3/127.6
L602	6200010160	S.COI AS080440-22N	T	65.7/132.8
L603	6200010150	S.COI AS080340-15N	T	60.9/133.6
L705	6200003550	S.COI MLF1608A 4R7K-T	B	68.2/10.3
L706	6200011300	S.COI EXCML16A270U	T	91.0/6.9
L707	6200011300	S.COI EXCML16A270U	T	91.0/6.9
L801	6200011410	S.COI C2520C-82NG-A	T	55.8/55.5
L802	6200010650	S.COI C2520C-R12G-A (0.12U)	T	58.5/52.1
L803	6200007420	S.COI ELJFC 101K-F	B	50.5/39.8
L820	6200006430	S.COI ELJFC 180K-F	B	52.9/97.4
L821	6140002020	COI LR-229 (T50-10)		
L822	6140003540	COI LR-396		
L823	6200006430	S.COI ELJFC 180K-F	B	2.8/106.8
L840	6200007420	S.COI ELJFC 101K-F	B	49.3/98.5
L841	6140001820	COI LR-218 (T50-10)		
L842	6140001800	COI LR-216 (T50-2)		
L843	6140001800	COI LR-216 (T50-2)		
L844	6200007420	S.COI ELJFC 101K-F	B	2.6/90.7
L860	6200004440	S.COI ELJFC 4R7M-F	B	50.3/83.8
L861	6110003550	COI LA-547 (LA-214A)		
L862	6110003570	COI LA-550		
L863	6110003540	COI LA-548 (LA-215A)		
L864	6200004440	S.COI ELJFC 4R7M-F	B	2.8/74.5
L880	6200007420	S.COI ELJFC 101K-F	B	50.4/69.1
L881	6140002570	COI LR-294 (T50-2)		
L882	6140002580	COI LR-295 (T50-2)		
L883	6200007420	S.COI ELJFC 101K-F	B	2.6/98.4
L884	6200008600	S.COI ELJFC 560K-F	B	50.0/54.6
L901	6140002560	COI LR-293 (T50-10)		
L902	6140002560	COI LR-293 (T50-10)		
L903	6140002560	COI LR-293 (T50-10)		
L904	6200008600	S.COI ELJFC 560K-F	B	2.6/42.3
L920	6200007420	S.COI ELJFC 101K-F	B	50.4/25.4
L921	6140001780	COI LR-214 (T50-2)		
L922	6140001780	COI LR-214 (T50-2)		
L923	6200007420	S.COI ELJFC 101K-F	B	2.6/26.1
L940	6200007390	S.COI ELJFC 120K-F	B	47.3/9.9
L941	6140003450	COI LR-387 (T50-10)		
L942	6140003460	COI LR-388 (T50-10)		
L943	6200007420	S.COI ELJFC 101K-F	B	41.1/11.1
L944	6200007390	S.COI ELJFC 120K-F	B	9.0/10.5
L960	6200007420	S.COI ELJFC 101K-F	B	45.3/130.6
L961	6140003490	COI LR-391 (TR10X5X5 3A6)		
L980	6200007420	S.COI ELJ		

[PA UNIT]

REF NO.	PARTS NO.	DESCRIPTION	M.	H/V LOCATION
R109	7030008190	S.RES ERJ12YJ330U (33)	B	145.5/32.7
R110	7030000230	S.RES MCR10EZHH 56 (560)	T	149.4/39.8
R111	7030003410	S.RES ERJ3GEYJ 561 V (560)	B	143.8/42.1
R112	7030003510	S.RES ERJ3GEYJ 392 V (3.9K)	B	146.1/37.5
R113	7030003540	S.RES ERJ3GEYJ 682 V (6.8K)	B	146.1/37.5
R116	7030000340	S.RES MCR10EZHH 470 (471)	B	141.4/40.9
R117	7030003860	S.RES ERJ3GE JPW V	T	146.7/47.7
R151	7030003380	S.RES ERJ3GEYJ 331 V (330)	B	61.6/37.8
R152	7030003440	S.RES ERJ3GEYJ 102 V (1K)	B	61.8/60.1
R153	7030003520	S.RES ERJ3GEYJ 472 V (4.7K)	T	59.2/58.0
R201	7030003320	S.RES ERJ3GEYJ 101 V (100)	B	123.0/50.1
R202	7030003520	S.RES ERJ3GEYJ 472 V (4.7K)	B	136.0/49.9
R204	7030003440	S.RES ERJ3GEYJ 102 V (1K)	B	138.0/52.8
R205	7030010420	S.RES ERJ1TYJ 560U (56)	B	145.0/51.5
R301	7030009300	S.RES ERJ1WYOR00U	B	92.2/84.4
R302	7030010520	S.RES ERJ1TYJ 101U (100)	T	89.4/86.1
R303	7030009300	S.RES ERJ1WYOR00U	B	85.4/84.4
R304	7030003320	S.RES ERJ3GEYJ 101 V (100)	T	107.1/79.8
R305	7030010410	S.RES ERJ1TYJ 220U (22)	T	100.2/84.1
R306	7030003320	S.RES ERJ3GEYJ 101 V (100)	B	71.3/83.3
R307	7030010410	S.RES ERJ1TYJ 220U (22)	T	77.5/84.1
R308	7030003480	S.RES ERJ3GEYJ 222 V (2.2K)	B	99.1/85.0
R309	7030003480	S.RES ERJ3GEYJ 222 V (2.2K)	B	78.8/85.0
R310	7030007630	S.RES MCR100JZHJ 0.68 (R68)	B	100.1/82.2
R311	7030007630	S.RES MCR100JZHJ 0.68 (R68)	B	78.3/82.1
R312	7030011250	S.RES ERJ1TYJ 390U (39)	T	100.9/77.7
R313	7030010540	S.RES ERJ1TYJ 330U (33)	T	97.2/77.7
R314	7030010540	S.RES ERJ1TYJ 330U (33)	T	81.6/77.7
R315	7030011250	S.RES ERJ1TYJ 390U (39)	T	77.9/77.7
R317	7030010950	S.RES ERJ1TYJ 100U (10)	B	104.0/20.6
R318	7030010950	S.RES ERJ1TYJ 100U (10)	B	99.6/20.6
R319	7030010660	S.RES ERJ1TYJ 6R8U (6.8)	B	89.4/54.6
R402	7030003320	S.RES ERJ3GEYJ 101 V (100)	B	151.7/73.2
R403	7030003520	S.RES ERJ3GEYJ 472 V (4.7K)	T	151.8/71.3
R404	7030000260	S.RES MCR10EZHH 100 (101)	T	149.5/76.0
R405	7030003540	S.RES ERJ3GEYJ 682 V (6.8K)	B	126.8/137.6
R406	7030003860	S.RES ERJ3GE JPW V	B	128.4/136.1
R407	7030003440	S.RES ERJ3GEYJ 102 V (1K)	B	129.7/133.6
R408	7030003860	S.RES ERJ3GE JPW V	B	124.1/137.6
R409	7030003440	S.RES ERJ3GEYJ 102 V (1K)	B	127.1/130.4
R410	7030003440	S.RES ERJ3GEYJ 102 V (1K)	B	131.6/133.0
R411	7030003540	S.RES ERJ3GEYJ 682 V (6.8K)	B	125.2/135.5
R412	7030003500	S.RES ERJ3GEYJ 332 V (3.3K)	B	131.1/129.7
R413	7030007160	S.RES ERJ12YJ3R3U (3.3)	B	123.6/125.2
R415	7030008350	S.RES ERJ12YJ390U	B	86.8/136.5
R416	7030000140	S.RES MCR10EZHH 10 (100)	B	93.8/130.8
R417	7030000140	S.RES MCR10EZHH 10 (100)	B	95.6/132.5
R418	7030000010	S.RES MCR10EZHH JPW (000)	B	99.4/133.9
R451	7030003470	S.RES ERJ3GEYJ 182 V (1.8K)	B	81.5/121.7
R452	7030004040	S.RES ERJ3GEYJ 4R7 V (4.7)	B	85.5/119.3
R453	7030003260	S.RES ERJ3GEYJ 330 V (33)	B	81.6/118.4
R454	7030003860	S.RES ERJ3GE JPW V	B	77.3/116.0
R455	7030003640	S.RES ERJ3GEYJ 473 V (47K)	B	73.2/117.5
R456	7030003700	S.RES ERJ3GEYJ 154 V (150K)	B	72.0/114.5
R457	7030003750	S.RES ERJ3GEYJ 394 V (390K)	B	71.2/111.9
R458	7030003710	S.RES ERJ3GEYJ 184 V (180K)	B	73.9/112.5
R459	7030003740	S.RES ERJ3GEYJ 334 V (330K)	B	69.6/111.3
R460	7030003740	S.RES ERJ3GEYJ 334 V (330K)	B	76.7/112.1
R461	7030003270	S.RES ERJ3GEYJ 390 V (39)	B	77.7/103.4
R462	7030003680	S.RES ERJ3GEYJ 104 V (100K)	B	72.9/99.6
R463	7030003520	S.RES ERJ3GEYJ 472 V (4.7K)	B	74.4/102.4
R464	7030003210	S.RES ERJ3GEYJ 120 V (12)	B	74.1/105.7
R465	7030003680	S.RES ERJ3GEYJ 104 V (100K)	B	66.6/101.8
R466	7030003860	S.RES ERJ3GE JPW V	B	62.2/100.2
R467	7030003640	S.RES ERJ3GEYJ 473 V (47K)	B	75.1/117.2
R468	7030008240	S.RES ERJ12YR00U	B	89.2/122.0
R470	7030003320	S.RES ERJ3GEYJ 101 V (100)	B	67.8/98.9
R471	7030003270	S.RES ERJ3GEYJ 390 V (39)	B	69.7/98.3
R472	7030003340	S.RES ERJ3GEYJ 151 V (150)	B	69.7/99.5
R473	7030003340	S.RES ERJ3GEYJ 151 V (150)	B	69.7/100.7
R474	7030003340	S.RES ERJ3GEYJ 151 V (150)	B	63.5/97.0
R475	7030003340	S.RES ERJ3GEYJ 151 V (150)	B	60.9/97.0
R476	7030003270	S.RES ERJ3GEYJ 390 V (39)	B	64.9/95.1
R477	7030003360	S.RES ERJ3GEYJ 221 V (220)	B	61.8/97.6
R502	7030003320	S.RES ERJ3GEYJ 101 V (100)	T	112.1/87.9
R503	7030003520	S.RES ERJ3GEYJ 472 V (4.7K)	T	112.6/86.0
R504	7030000260	S.RES MCR10EZHH 100 (101)	T	114.2/86.2
R505	7030003540	S.RES ERJ3GEYJ 682 V (6.8K)	B	120.0/124.8
R507	7030003440	S.RES ERJ3GEYJ 102 V (1K)	B	110.2/123.1
R508	7030003520	S.RES ERJ3GEYJ 472 V (4.7K)	B	107.1/121.5
R510	7030003440	S.RES ERJ3GEYJ 102 V (1K)	B	110.4/125.8
R511	7030003540	S.RES ERJ3GEYJ 682 V (6.8K)	B	112.1/134.0
R512	7030003560	S.RES ERJ3GEYJ 103 V (10K)	B	107.1/123.1
R513	7030010520	S.RES ERJ1TYJ 101U (100)	B	103.7/114.2
R515	7030006060	S.RES ERJ12YJ100U (10)	T	92.1/109.0
R516	7030003860	S.RES ERJ3GE JPW V	T	90.6/114.3
R517	7030010520	S.RES ERJ1TYJ 101U (100)	B	103.7/118.4
R518	7030003440	S.RES ERJ3GEYJ 102 V (1K)	B	97.5/112.7
R519	7030000010	S.RES MCR10EZHH JPW (000)	B	111.2/119.1
R551	7030003470	S.RES ERJ3GEYJ 182 V (1.8K)	T	78.2/117.8
R552	7030004040	S.RES ERJ3GEYJ 4R7 V (4.7)	T	76.7/119.1
R553	7030003260	S.RES ERJ3GEYJ 330 V (33)	T	73.1/119.0
R554	7030003680	S.RES ERJ3GEYJ 104 V (100K)	T	66.8/120.5
R555	7030003440	S.RES ERJ3GEYJ 102 V (1K)	T	68.1/114.7
R556	7030003680	S.RES ERJ3GEYJ 104 V (100K)	T	70.0/116.7
R557	7030003740	S.RES ERJ3GEYJ 334 V (330K)	T	65.7/112.9
R558	7030003710	S.RES ERJ3GEYJ 184 V (180K)	T	70.5/111.2
R559	7030003720	S.RES ERJ3GEYJ 224 V (220K)	T	65.7/111.7
R560	7030003720	S.RES ERJ3GEYJ 224 V (220K)	T	65.6/110.5
R561	7030003740	S.RES ERJ3GEYJ 334 V (330K)	T	68.3/112.4
R562	7030003270	S.RES ERJ3GEYJ 390 V (39)	T	70.1/106.6
R563	7030003420	S.RES ERJ3GEYJ 681 V (680)	T	65.4/107.3
R564	7030003210	S.RES ERJ3GEYJ 120 V (12)	T	63.5/103.0
R565	7030003440	S.RES ERJ3GEYJ 102 V (1K)	B	65.7/106.4
R567	7030003680	S.RES ERJ3GEYJ 104 V (100K)	T	70.1/104.0

Eqv.= This component is equivalent to the REF No. component listed above, and may be substituted on parts orders and repairs.

[PA UNIT]

REF NO.	PARTS NO.	DESCRIPTION	M.	H/V LOCATION
R568	7030003680	S.RES ERJ3GEYJ 104 V (100K)	T	69.8/100.8
R570	7030003380	S.RES ERJ3GEYJ 331 V (330)	T	62.8/100.3
R575	7030003520	S.RES ERJ3GEYJ 472 V (4.7K)	T	68.5/100.8
R576	7030003540	S.RES ERJ3GEYJ 682 V (6.8K)	T	71.8/100.0
R577	7030003520	S.RES ERJ3GEYJ 472 V (4.7K)	T	68.0/120.5
R578	7030003540	S.RES ERJ3GEYJ 682 V (6.8K)	T	70.0/119.1
R701	7030003500	S.RES ERJ3GEYJ 332 V (3.3K)	B	82.2/16.9
R702	7030003500	S.RES ERJ3GEYJ 332 V (3.3K)	B	83.1/14.6
R703	7030003500	S.RES ERJ3GEYJ 332 V (3.3K)	B	80.6/16.9
R704	7030003500	S.RES ERJ3GEYJ 332 V (3.3K)	B	79.8/14.6
R705	7030009300	S.RES ERJ1WYOR00U	B	134.7/23.9
R721	7030011240	S.RES LRF3W-LF-01-R020F	B	83.0/22.3
R722	7030011240	S.RES LRF3W-LF-01-R020F	B	83.0/29.6
R723	7030004040	S.RES ERJ3GEYJ 4R7 V (4.7)	B	140.6/14.7
R733	7030009591	S.RES ERA3YED 472V (4.7K)	B	138.6/10.4
R734	7510001470	S.THE NTCG20 4AG 473JT	T	111.9/58.2
R735	7030009591	S.RES ERA3YED 472V (4.7K)	B	140.2/12.5
R736	7510001470	S.THE NTCG20 4AG 473JT	T	153.4/77.2
R742	7030003640	S.RES ERJ3GEYJ 473 V (47K)	B	83.4/11.5
R743	7030003440	S.RES ERJ3GEYJ 102 V (1K)	B	80.2/11.0
R744	7030003860	S.RES ERJ3GE JPW V	T	67.8/9.6
R749	7030003860	S.RES ERJ3GE JPW V	B	65.0/5.3
R750	7030003860	S.RES ERJ3GE JPW V	B	66.7/5.3
R773	7030003860	S.RES ERJ3GE JPW V	T	103.4/9.6
R960	7030003860	S.RES ERJ3GE JPW V	B	43.2/125.7
R961	7030003380	S.RES ERJ3GEYJ 331 V (330)	B	42.0/138.3
R962	7030003440	S.RES ERJ3GEYJ 102 V (1K)	B	37.4/137.9
R963	7030003440	S.RES ERJ3GEYJ 102 V (1K)	B	40.3/126.3
R964	7030003860	S.RES ERJ3GE JPW V	B	24.8/131.2
R965	7030003640	S.RES ERJ3GEYJ 473 V (47K)	B	32.6/130.6
R966	7030008190	S.RES ERJ12YJ330U (33)	B	11.1/129.6
R967	7030003640	S.RES ERJ3GEYJ 473 V (47K)	B	34.2/130.6
R968	7030003860	S.RES ERJ3GE JPW V	B	24.8/132.8
R969	7030003860	S.RES ERJ3GEYJ 223 V (22K)	B	32.6/133.7
R970	7030003680	S.RES ERJ3GEYJ 104 V (100K)	B	34.2/133.7
R971	7540000130	ABS 2P-50A-301	B	17.4/140.1
R972	7030003620	S.RES ERJ3GEYJ 333 V (33K)	B	18.9/138.5
R973	7030003620	S.RES ERJ3GEYJ 333 V (33K)	B	19.4/136.6
R974	7030003620	S.RES ERJ3GEYJ 333 V (33K)	B	22.4/136.6
R994	7030003560	S.RES ERJ3GEYJ 103 V (10K)	B	22.4/6.8
R995	7030003560	S.RES ERJ3GEYJ 103 V (10K)	B	21.6/5.4
R996	7030003560	S.RES ERJ3GEYJ 103 V (10K)	B	21.6/5.4
R997	7030003560	S.RES ERJ3GEYJ 103 V (10K)	B	21.6/8.2
R998	7030003320	S.RES ERJ3GEYJ 101 V (100)	T	54.1/4.4
R999	7030003320	S.RES ERJ3GEYJ 101 V (100)	T	54.5/3.1
R1000	7030003320	S.RES ERJ3GEYJ 101 V (100)	T	51.2/3.5
R1001	7030003320	S.RES ERJ3GEYJ 101 V (100)	T	49.4/4.9
R1002	7030000280	S.RES MCR10EZHH 150 (151)	T	48.0/9.7
R1003	7030000290	S.RES MCR10EZHH 180 (181)	T	47.5/7.9
C101	4030011600	S.CER C1608 JB 1E 104K-T	T	152.0/25.2
C102	4030011600	S.CER C1608 JB 1E 104K-T	B	150.8/29.3
C103	4030011340	S.CER C1608 CH 1H 471J-T	T	152.7/27.2
C104	4030011600	S.CER C1608 JB 1E 104K-T	T	147.8/32.2
C105	4510004591	ELE 16 ME 470 HC	B	142.7/29.2
C106	4030011600	S.CER C1608 JB 1E 104K-T	B	151.6/39.7
C107	4030011600	S.CER C1608 JB 1E 104K-T	T	149.2/36.5
C108	4030011600	S.CER C1608 JB 1E 104K-T	B	146.6/42.1
C109	4030007130	S.CER C1608 CH 1H 101J-T	B	139.2/35.1
C112	4030011600	S.CER C1608 JB 1E 104K-T	T	144.6/44.4
C113	4030011600	S.CER C1608 JB 1E 104K-T	T	134.1/37.0
C114	4030011600	S.CER C1608 JB 1E 104K-T	B	144.6/45.8
C116	4030007090	S.CER C1608 CH 1H 470J-T	T	143.5/48.5
C118	4030007130	S.CER C1608 CH 1H 101J-T	T	144.0/50.4
C119	4030007130	S.CER C1608 CH 1H 101J-T	T	143.5/47.2
C120	4030007130	S.CER C1608 CH 1H 120J-T	T	121.5/11.2
C122	4510008500	S.ELE EEE1CA101WP	T	59.2/54.9
C151	4030011600	S.CER C1608 JB 1E 104K-T	B	61.6/36.2
C152	4030006880	S.CER C1608 JB 1H 472K-T	B	63.1/56.0
C153	4030011600	S.CER C1608 JB 1E 104K-T	B	63.1/56.0
C154	4030006880	S.CER C1608 JB 1H 102K-T	T	145.6/53.1
C201	4030006880	S.CER C1608 JB 1H 102K-T	T	143.0/53.1
C202	4030006880	S.CER C1608 JB 1H 102K-T	B	139.3/48.4

[PA UNIT]

REF NO.	PARTS NO.	DESCRIPTION	M.	H/V LOCATION
C303	4030011600	S.CER C1608 JB 1E 104K-T	B	110.8/85.5
C304	4030017320	S.CER GRM21BB11H104KA01L (GRM40-034)	B	94.8/97.6
C305	4510004591	ELE 16 ME 470 HC	B	83.6/39.9
C306	4030004720	S.CER C2012 JB 1H 102K-T [EUR]	B	
	4030004720	S.CER C2012 JB 1H 102K-T [FRA]		
	4030004720	S.CER C2012 JB 1H 102K-T [ESP]		
	4030004720	S.CER C2012 JB 1H 102K-T [USA]		
	4030004720	S.CER C2012 JB 1H 102K-T [ITR]		
	4030004720	S.CER C2012 JB 1H 102K-T [UK]		
	4030004720	S.CER C2012 JB 1H 102K-T [KOR]		
	4030006860	S.CER C1608 JB 1H 102K-T [AUS]		
	4030004720	S.CER C2012 JB 1H 102K-T [CHN]		
C307	4030004720	S.CER C2012 JB 1H 102K-T [EUR]	B	100.7/39.9
	4030004720	S.CER C2012 JB 1H 102K-T [FRA]		
	4030004720	S.CER C2012 JB 1H 102K-T [ESP]		
	4030004720	S.CER C2012 JB 1H 102K-T [USA]		
	4030004720	S.CER C2012 JB 1H 102K-T [ITR]		
	4030004720	S.CER C2012 JB 1H 102K-T [UK]		
	4030006860	S.CER C1608 JB 1H 102K-T [AUS]		
	4030004720	S.CER C2012 JB 1H 102K-T [CHN]		
C308	4030004720	S.CER C2012 JB 1H 102K-T [EUR]	B	92.0/11.0
	4030004720	S.CER C2012 JB 1H 102K-T [FRA]		
	4030004720	S.CER C2012 JB 1H 102K-T [ESP]		
	4030004720	S.CER C2012 JB 1H 102K-T [USA]		
	4030004720	S.CER C2012 JB 1H 102K-T [ITR]		
	4030004720	S.CER C2012 JB 1H 102K-T [UK]		
	4030004720	S.CER C2012 JB 1H 102K-T [KOR]		
	4030006860	S.CER C1608 JB 1H 102K-T [AUS]		
	4030004720	S.CER C2012 JB 1H 102K-T [CHN]		
C309	4030011600	S.CER C1608 JB 1E 104K-T	T	105.8/78.3
C311	4030018750	S.CER C3225 CH 2J 682K-T	B	92.7/78.5
C312	4030018750	S.CER C3225 CH 2J 682K-T	B	86.1/78.5
C313	4030011600	S.CER C1608 JB 1E 104K-T	T	76.8/87.8
C314	4030018750	S.CER C3225 CH 2J 682K-T	B	96.9/77.6
C315	4030018750	S.CER C3225 CH 2J 682K-T	B	81.9/77.6
C319	4030011730	S.CER GRM31M2C2H101JV01L (GRM42-6 CH)	B	110.0/48.8
C320	4030011730	S.CER GRM31M2C2H101JV01L (GRM42-6 CH)	B	71.1/48.9
C323	4030003810	S.MIC UC342H 1200J-T	B	91.5/46.4
C324	4320001050	S.MIC UC342H 3900J-T	T	94.4/40.2
C325	4320001070	S.MIC UC342H 3300J-T	B	94.4/40.7
C327	4030011790	S.CER GRM55RF52A684ZD01L (GRM44-1)	T	65.9/46.3
C331	4030011600	S.CER C1608 JB 1E 104K-T	T	108.3/78.3
C332	4030011600	S.CER C1608 JB 1E 104K-T	B	69.5/81.4
C333	4030018940	S.CER GRM31A7U2J331JW31D	B	88.4/101.8
C340	4030006860	S.CER C1608 JB 1H 102K-T	B	82.3/107.4
C341	4030006860	S.CER C1608 JB 1H 102K-T	B	92.5/107.4
C342	4030006860	S.CER C1608 JB 1H 102K-T	B	87.2/91.7
C350	4030004720	S.CER C2012 JB 1H 102K-T [EUR]	B	103.4/39.9
	4030004720	S.CER C2012 JB 1H 102K-T [FRA]		
	4030004720	S.CER C2012 JB 1H 102K-T [ESP]		
	4030004720	S.CER C2012 JB 1H 102K-T [USA]		
	4030004720	S.CER C2012 JB 1H 102K-T [ITR]		
	4030004720	S.CER C2012 JB 1H 102K-T [UK]		
	4030004720	S.CER C2012 JB 1H 102K-T [KOR]		
	4030004720	S.CER C2012 JB 1H 102K-T [CHN]		
C351	4030004720	S.CER C2012 JB 1H 102K-T [EUR]	B	106.2/39.9
	4030004720	S.CER C2012 JB 1H 102K-T [FRA]		
	4030004720	S.CER C2012 JB 1H 102K-T [ESP]		
	4030004720	S.CER C2012 JB 1H 102K-T [USA]		
	4030004720	S.CER C2012 JB 1H 102K-T [ITR]		
	4030004720	S.CER C2012 JB 1H 102K-T [UK]		
	4030004720	S.CER C2012 JB 1H 102K-T [KOR]		
	4030004720	S.CER C2012 JB 1H 102K-T [CHN]		
C353	4030004720	S.CER C2012 JB 1H 102K-T [EUR]	B	86.4/39.9
	4030004720	S.CER C2012 JB 1H 102K-T [FRA]		
	4030004720	S.CER C2012 JB 1H 102K-T [ESP]		
	4030004720	S.CER C2012 JB 1H 102K-T [USA]		
	4030004720	S.CER C2012 JB 1H 102K-T [ITR]		
	4030004720	S.CER C2012 JB 1H 102K-T [UK]		
	4030004720	S.CER C2012 JB 1H 102K-T [KOR]		
	4030004720	S.CER C2012 JB 1H 102K-T [CHN]		
C354	4030004720	S.CER C2012 JB 1H 102K-T [EUR]	B	89.2/39.9
	4030004720	S.CER C2012 JB 1H 102K-T [FRA]		
	4030004720	S.CER C2012 JB 1H 102K-T [ESP]		
	4030004720	S.CER C2012 JB 1H 102K-T [USA]		
	4030004720	S.CER C2012 JB 1H 102K-T [ITR]		
	4030004720	S.CER C2012 JB 1H 102K-T [UK]		
	4030004720	S.CER C2012 JB 1H 102K-T [KOR]		
	4030004720	S.CER C2012 JB 1H 102K-T [CHN]		
C356	4030004720	S.CER C2012 JB 1H 102K-T [EUR]	B	97.5/11.0
	4030004720	S.CER C2012 JB 1H 102K-T [FRA]		
	4030004720	S.CER C2012 JB 1H 102K-T [ESP]		
	4030004720	S.CER C2012 JB 1H 102K-T [USA]		
	4030004720	S.CER C2012 JB 1H 102K-T [ITR]		
	4030004720	S.CER C2012 JB 1H 102K-T [UK]		
	4030004720	S.CER C2012 JB 1H 102K-T [KOR]		
	4030004720	S.CER C2012 JB 1H 102K-T [CHN]		
C357	4030004720	S.CER C2012 JB 1H 102K-T [EUR]	B	94.8/11.0
	4030004720	S.CER C2012 JB 1H 102K-T [FRA]		
	4030004720	S.CER C2012 JB 1H 102K-T [ESP]		
	4030004720	S.CER C2012 JB 1H 102K-T [USA]		
	4030004720	S.CER C2012 JB 1H 102K-T [ITR]		
	4030004720	S.CER C2012 JB 1H 102K-T [UK]		
	4030004720	S.CER C2012 JB 1H 102K-T [KOR]		
	4030004720	S.CER C2012 JB 1H 102K-T [CHN]		

Eqv.= This component is equivalent to the REF No. component listed above, and may be substituted on parts orders and repairs.

[PA UNIT]

REF NO.	PARTS NO.	DESCRIPTION	M.	H/V LOCATION
C358	4030006860	S.CER C1608 JB 1H 102K-T [EUR]	B	90.1/91.7
	4030006860	S.CER C1608 JB 1H 102K-T [FRA]		
	4030006860	S.CER C1608 JB 1H 102K-T [ESP]		
	4030006860	S.CER C1608 JB 1H 102K-T [USA]		
	4030006860	S.CER C1608 JB 1H 102K-T [ITR]		
	4030006860	S.CER C1608 JB 1H 102K-T [UK]		
	4030006860	S.CER C1608 JB 1H 102K-T [KOR]		
	4030006860	S.CER C1608 JB 1H 102K-T [CHN]		
C359	4030006860	S.CER C1608 JB 1H 102K-T [EUR]	B	94.9/107.4
	4030006860	S.CER C1608 JB 1H 102K-T [FRA]		
	4030006860	S.CER C1608 JB 1H 102K-T [ESP]		
	4030006860	S.CER C1608 JB 1H 102K-T [USA]		
	4030006860	S.CER C1608 JB 1H 102K-T [ITR]		
	4030006860	S.CER C1608 JB 1H 102K-T [UK]		
	4030006860	S.CER C1608 JB 1H 102K-T [KOR]		
	4030006860	S.CER C1608 JB 1H 102K-T [CHN]		
C360	4030006860	S.CER C1608 JB 1H 102K-T [EUR]	B	85.1/107.4
	4030006860	S.CER C1608 JB 1H 102K-T [FRA]		
	4030006860	S.CER C1608 JB 1H 102K-T [ESP]		
	4030006860	S.CER C1608 JB 1H 102K-T [USA]		
	4030006860	S.CER C1608 JB 1H 102K-T [ITR]		
	4030006860	S.CER C1608 JB 1H 102K-T [UK]		
	4030006860	S.CER C1608 JB 1H 102K-T [KOR]		
	4030006860	S.CER C1608 JB 1H 102K-T [CHN]		
C403	4030006860	S.CER C1608 JB 1H 102K-T	B	89.6/133.4
C404	4030006860	S.CER C1608 JB 1H 102K-T	B	151.7/71.5
C405	4030011740	S.CER GRM32N2C2H201JV01L (GRM42-2 CH)	T	145.4/105.7
C406	4030006860	S.CER C1608 JB 1H 102K-T	B	132.4/129.7
C408	4030018040	S.CER ERF22X 6C2H 180J D01L	B	134.2/93.0
C409	4030018040	S.CER ERF22X 6C2H 180J D01L	B	145.4/93.0
C410	4030018260	S.CER ERF22X 6C2H 150J D01L	B	145.4/96.4
C411	4030018260	S.CER ERF22X 6C2H 150J D01L	B	134.2/96.4
C412	4030018770	S.CER C3216 CH 2J 102J-T	T	136.0/111.5
C413	4030018770	S.CER C3216 CH 2J 102J-T	T	139.9/102.8
C415	4030018410	S.CER ERF22X 6C2H 2R0C D01L	T	143.1/139.4
C416	4030006880	S.CER C1608 JB 1H 472K-T	T	103.1/96.7
C417	4030018040	S.CER ERF22X 6C2H 180J D01L	T	139.2/136.2
C418	4030011120	S.CER GRM31M2C2H100JV01L (GRM42-6 CH)	B	134.1/134.2
C419	4030011020	S.CER GRM31M4C2H1R0CY21L (GRM42-6 CK)	B	132.6/138.3
C420	4030011080	S.CER GRM31M2C2H6R0DV01L (GRM42-6 CH)	B	129.2/139.5
C421	4030011020	S.CER GRM31M4C2H1R0CY21L (GRM42-6 CK)	B	120.6/136.8
C422	4030011120	S.CER GRM31M2C2H100JV01L (GRM42-6 CH)	B	121.7/141.1
C423	4030007090	S.CER C1608 CH 1H 470J-T	B	127.8/131.7
C425	4030011180	S.CER GRM31M2C2H220JV01L (GRM42-6 CH)	T	121.6/137.4
C426	4030006860	S.CER C1608 JB 1H 102K-T	B	106.8/133.9
C427	4030011020	S.CER GRM31M4C2H1R0CY21L (GRM42-6 CK)	B	102.1/139.6
C428	4030011090	S.CER GRM31M2C2H7R0DV01L (GRM42-6 CH)	T	97.0/138.1
C429	4030017940	S.CER ERF22X 6C2H 680J D01L	T	92.3/136.9
C430	4030019410	S.CER GRM31A7U2J471JW31D	B	94.3/138.1
C431	4030011070	S.CER GRM31M2C2H5R0CY21L (GRM42-6 CH)	T	86.9/133.8
C432	4030004820	S.CER C2012 CH 1H 050C-T	B	99.2/139.3
C433	4030011090	S.CER GRM31M2C2H7R0DV01L (GRM42-6 CH)	T	76.1/132.2
C434	4030006860	S.CER C1608 JB 1H 102K-T	B	90.0/124.9
C435	4030006860	S.CER C1608 JB 1H 102K-T	B	97.2/127.8
C436	4030006860	S.CER C1608 JB 1H 102K-T	T	98.4/130.9
C438	4030006880	S.CER C1608 JB 1H 471K-T	B	90.8/134.1
C439	4030006860	S.CER C1608 JB 1H 102K-T	B	92.9/133.2
C440	4030004710	S.CER C2012 JB 1H 471K-T	B	103.6/135.6
C441	4030011090	S.CER GRM31M2C2H7R0DV01L (GRM42-6 CH)	T	137.6/140.4
C444	4030006860	S.CER C1608 JB 1H 102K-T	B	59.3/117.9
C445	4030011090	S.CER GRM31M2C2H7R0DV01L (GRM42-6 CH)	B	109.8/139.2
C452	4030007020	S.CER C1608 CH 1H 120J-T	B	87.3/119.3
C453	4030006860	S.CER C1608 JB 1H 102K-T	T	63.9/117.3
C456	4030009350	S.CER C1608 CH 1H 3R5B-T	B	78.2/118.4
C458	4030006860	S.CER C1608 JB 1H 102K-T	T	73.8/113.1
C461	4030011600	S.CER C1608 JB 1E 104K-T	B	68.9/113.4
C462	4030011600	S.CER C1608 JB 1E 104K-T	B	77.1/110.8
C463	4030006860	S.CER C1608 JB 1H 102K-T	B	79.7/109.6
C464	4030011600	S.CER C1608 JB 1E 104K-T	B	77.7/106.0
C465	4030011600	S.CER C1608 JB 1E 104K-T	B	67.8/109.0
C466	4030006860	S.CER C1608 JB 1H 102K-T	B	77.7/104.7
C467	4030006860	S.CER C1608 JB 1H 102K-T	B	67.8/107.7
C468	4030007020	S.CER C1608 CH 1H 120J-T	B	73.7/101.1
C470	4030011600	S.CER C1608 JB 1E 104K-T	B	

[PA UNIT]

REF NO.	PARTS NO.	DESCRIPTION	M.	H/V LOCATION
C504	4030017960	S.CER ERF22X 6C2H 330J D01L	T	111.8/122.1
C505	4030011040	S.CER GRM31M4C2H2R0CY21L (GRM42-6 CK)	B	114.4/125.4
C506	4030011120	S.CER GRM31M2C2H100JV01L (GRM42-6 CH)	B	118.3/125.6
C507	4030011040	S.CER GRM31M4C2H2R0CY21L (GRM42-6 CK)	B	113.9/131.5
C508	4030011070	S.CER GRM31M2C2H5R0CY21L (GRM42-6 CH)	B	110.4/132.9
C509	4030007150	S.CER C1608 CH 1H 151J-T	B	110.2/121.5
C511	4030018770	S.CER C3216 CH 2J 102J-T	T	109.6/125.5
C513	4030006860	S.CER C1608 JB 1H 102K-T	B	97.1/117.6
C514	4030011170	S.CER GRM31M2C2H180JV01L (GRM42-6 CH)	T	98.4/118.1
C515	4030018770	S.CER C3216 CH 2J 102J-T	T	96.9/120.4
C516	4030011100	S.CER GRM31M2C2H8R0DV01L (GRM42-6 CH)	T	88.2/124.1
C517	4030004880	S.CER C2012 CH 1H 120J-T	B	92.6/115.2
C518	4030018770	S.CER C3216 CH 2J 102J-T	B	94.1/121.5
C519	4030011190	S.CER GRM31M2C2H270JV01L (GRM42-6 CH)	T	86.1/124.1
C520	4030004870	S.CER C2012 CH 1H 100D-T	B	93.4/112.5
C521	4030011290	S.CER GRM31M2C2H240JV01L (GRM42-6 CH)	T	81.3/124.0
C522	4030006850	S.CER C1608 JB 1H 471K-T	T	96.4/107.8
C523	4030006860	S.CER C1608 JB 1H 102K-T	T	79.3/119.1
C524	4030006910	S.CER C1608 CH 1H 0R5C-T	T	79.9/121.0
C525	4030004720	S.CER C2012 JB 1H 102K-T	B	86.7/112.2
C526	4030007150	S.CER C1608 CH 1H 151J-T	B	113.4/121.5
C527	4030007150	S.CER C1608 CH 1H 151J-T	B	111.1/127.8
C528	4030006860	S.CER C1608 JB 1H 102K-T	B	96.2/114.5
C530	4030011230	S.CER GRM31M2C2H390JV01L (GRM42-6 CH)	T	120.8/113.4
C531	4030018770	S.CER C3216 CH 2J 102J-T	B	106.0/109.3
C532	4030018770	S.CER C3216 CH 2J 102J-T	B	103.1/109.2
C533	4030018770	S.CER C3216 CH 2J 102J-T	T	118.6/107.0
C534	4030017880	S.CER ERF22X 6C2H 560J D01L (GRM111)	B	112.7/103.9
C535	4030017880	S.CER ERF22X 6C2H 560J D01L (GRM111)	B	124.1/103.9
C536	4030017980	S.CER ERF22X 6C2H 470J D01L	T	101.0/110.8
C537	4030017940	S.CER ERF22X 6C2H 680J D01L	T	101.0/114.2
C538	4030017880	S.CER ERF22X 6C2H 560J D01L (GRM111)	T	131.2/117.6
C541	4030011060	S.CER GRM31M2C2H4R0CY21L (GRM42-6 CH)	T	125.1/123.8
C542	4030012480	S.CER GRM31M2C2H121JV01L (GRM42-6 CH)	T	123.4/128.8
C544	4030011730	S.CER GRM31M2C2H101JV01L (GRM42-6 CH)	T	129.9/123.5
C545	4030017940	S.CER ERF22X 6C2H 680J D01L	T	112.7/109.9
C551	4030006880	S.CER C1608 JB 1H 472K-T	T	80.1/117.1
C552	4030006860	S.CER C1608 JB 1H 102K-T	T	73.1/120.5
C553	4030006850	S.CER C1608 JB 1H 471K-T	T	69.4/114.8
C554	4030006860	S.CER C1608 JB 1H 102K-T	T	66.8/114.8
C555	4030006860	S.CER C1608 JB 1H 102K-T	T	63.1/111.7
C556	4030011600	S.CER C1608 JB 1E 104K-T	T	68.3/111.2
C557	4030006860	S.CER C1608 JB 1H 102K-T	T	70.8/108.5
C558	4030006860	S.CER C1608 JB 1H 102K-T	T	65.4/108.6
C559	4030006860	S.CER C1608 JB 1H 102K-T	T	66.1/103.5
C560	4030006860	S.CER C1608 JB 1H 102K-T	B	65.3/113.0
C561	4030006850	S.CER C1608 JB 1H 471K-T	T	70.1/105.0
C562	4030006860	S.CER C1608 JB 1H 102K-T	T	69.2/94.9
C563	4030006860	S.CER C1608 JB 1H 102K-T	T	62.3/106.1
C564	4030006860	S.CER C1608 JB 1H 102K-T	T	65.0/97.0
C565	4030006860	S.CER C1608 JB 1H 102K-T	T	62.3/103.0
C567	4030006860	S.CER C1608 JB 1H 102K-T	T	69.2/120.9
C601	4030011070	S.CER GRM31M2C2H5R0CY21L (GRM42-6 CH)	T	69.5/132.7
C602	4030011090	S.CER GRM31M2C2H7R0DV01L (GRM42-6 CH)	T	67.0/136.8
C701	4030017320	S.CER GRM21BB11H104KA01L (GRM40-034)	B	109.8/33.4
C702	4030006860	S.CER C1608 JB 1H 102K-T	B	107.7/33.2
C703	4030011600	S.CER C1608 JB 1E 104K-T	B	83.8/16.9
C704	4510004601	ELE 16 ME 1000 HC		
C705	4030011600	S.CER C1608 JB 1E 104K-T	B	79.0/16.9
C706	4510004601	ELE 16 ME 1000 HC		
C707	4030017320	S.CER GRM21BB11H104KA01L (GRM40-034)	B	67.1/18.6
C708	4030006900	S.CER C1608 JB 1H 103K-T	T	63.3/27.9
C709	4030006860	S.CER C1608 JB 1H 102K-T	T	63.3/26.6
C710	4030006850	S.CER C1608 JB 1H 471K-T	T	63.3/25.3
C711	4030007170	S.CER C1608 CH 1H 221J-T	T	63.3/24.0
C712	4030007170	S.CER C1608 CH 1H 221J-T	B	70.5/18.7
C713	4510004591	ELE 16 ME 470 HC		
C715	4030006860	S.CER C1608 JB 1H 102K-T	B	97.1/118.9
C718	4030011600	S.CER C1608 JB 1E 104K-T	B	128.4/19.3
C719	4030011600	S.CER C1608 JB 1E 104K-T	T	125.9/16.5
C720	4030011600	S.CER C1608 JB 1E 104K-T	B	130.6/38.8
C722	4030007130	S.CER C1608 CH 1H 101J-T	T	89.0/6.7
C723	4030007130	S.CER C1608 CH 1H 101J-T	T	78.3/3.1
C724	4030011340	S.CER C1608 CH 1H 471J-T	B	134.8/12.2
C725	4550007350	S.TAN F931C226MCMBMA	B	126.6/35.3
C726	4030006860	S.CER C1608 JB 1H 102K-T	B	91.4/111.1
C727	4030006860	S.CER C1608 JB 1H 102K-T	B	84.4/114.2
C728	4030006860	S.CER C1608 JB 1H 102K-T	B	91.3/112.6
C729	4030006860	S.CER C1608 JB 1H 102K-T	B	65.1/114.9
C732	4030011600	S.CER C1608 JB 1E 104K-T	T	71.9/2.6
C733	4030011600	S.CER C1608 JB 1E 104K-T	T	66.8/12.9
C734	4030006860	S.CER C1608 JB 1H 102K-T	B	63.6/1.9
C735	4030011600	S.CER C1608 JB 1E 104K-T	T	74.1/13.2
C736	4030011600	S.CER C1608 JB 1E 104K-T	B	67.4/1.9
C737	4030011600	S.CER C1608 JB 1E 104K-T	B	65.5/1.9
C738	4030011600	S.CER C1608 JB 1E 104K-T	B	68.2/14.5

Eqv.= This component is equivalent to the REF No. component listed above, and may be substituted on parts orders and repairs.

[PA UNIT]

REF NO.	PARTS NO.	DESCRIPTION	M.	H/V LOCATION
C739	4030011600	S.CER C1608 JB 1E 104K-T	B	69.8/14.5
C741	4030011600	S.CER C1608 JB 1E 104K-T	B	78.6/6.4
C742	4030011600	S.CER C1608 JB 1E 104K-T	T	69.4/12.9
C743	4030006860	S.CER C1608 JB 1H 102K-T	T	68.1/12.9
C744	4030011600	S.CER C1608 JB 1E 104K-T	T	70.7/12.9
C745	4030011600	S.CER C1608 JB 1E 104K-T	B	77.7/14.3
C746	4030011600	S.CER C1608 JB 1E 104K-T	B	76.3/15.1
C747	4030011600	S.CER C1608 JB 1E 104K-T	T	98.5/4.1
C749	4030011600	S.CER C1608 JB 1E 104K-T	T	96.7/6.4
C750	4030006880	S.CER C1608 JB 1H 472K-T	T	94.3/6.4
C751	4030006860	S.CER C1608 JB 1H 102K-T	T	95.5/6.4
C752	4030011600	S.CER C1608 JB 1E 104K-T	T	93.1/6.4
C753	4030006880	S.CER C1608 JB 1H 472K-T	B	59.9/10.7
C754	4030006860	S.CER C1608 JB 1H 102K-T	B	66.6/14.5
C755	4030006860	S.CER C1608 JB 1H 102K-T	B	58.5/119.2
C757	4030011600	S.CER C1608 JB 1E 104K-T	B	76.4/8.0
C759	4030006880	S.CER C1608 JB 1H 472K-T	T	72.8/13.2
C760	4030006880	S.CER C1608 JB 1H 472K-T	B	74.8/8.0
C761	4030006880	S.CER C1608 JB 1H 472K-T	B	73.2/8.0
C762	4030006880	S.CER C1608 JB 1H 472K-T	B	70.0/8.0
C763	4030006880	S.CER C1608 JB 1H 472K-T	B	71.6/8.0
C764	4030006880	S.CER C1608 JB 1H 472K-T	B	62.0/1.9
C765	4030011600	S.CER C1608 JB 1E 104K-T	B	69.0/1.9
C766	4030006860	S.CER C1608 JB 1H 102K-T	B	66.6/8.7
C781	4030006860	S.CER C1608 JB 1H 102K-T	T	73.1/90.1
C782	4030006900	S.CER C1608 JB 1H 103K-T	T	71.9/84.3
C783	4030006880	S.CER C1608 JB 1H 472K-T	T	71.9/83.1
C801	4030007070	S.CER C1608 CH 1H 330J-T	T	55.1/58.5
C802	4030009470	S.CER C1608 CH 1H R75C-T	T	53.8/58.5
C803	4030007100	S.CER C1608 CH 1H 560J-T	T	53.8/53.3
C804	4030007030	S.CER C1608 CH 1H 150J-T	T	56.2/52.5
C805	4030007080	S.CER C1608 CH 1H 390J-T	T	53.8/51.7
C806	4030006880	S.CER C1608 JB 1H 472K-T	B	47.1/39.8
C807	4030011600	S.CER C1608 JB 1E 104K-T	B	43.2/38.6
C808	4030011600	S.CER C1608 JB 1E 104K-T	B	43.2/44.6
C820	4030011600	S.CER C1608 JB 1E 104K-T	B	54.2/91.3
C821	4030006880	S.CER C1608 JB 1H 472K-T	B	53.6/99.3
C822	4030011510	S.CER GRM31M2C2H560JV01L (GRM42-6 CH)	B	42.3/21.9
C823	4030011190	S.CER GRM31M2C2H270JV01L (GRM42-6 CH)	B	33.0/18.3
C824	4030012480	S.CER GRM31M2C2H121JV01L (GRM42-6 CH)	B	25.2/17.1
C825	4030011240	S.CER GRM31M2C2H470JV01L (GRM42-6 CH)	B	17.9/15.7
C826	4030011550	S.CER GRM31M2C2H680JV01L (GRM42-6 CH)	B	11.2/19.9
C827	4030011510	S.CER GRM31M2C2H560JV01L (GRM42-6 CH)	B	8.8/19.9
C828	4030006880	S.CER C1608 JB 1H 472K-T	T	5.2/106.8
C829	4030011600	S.CER C1608 JB 1E 104K-T	T	2.6/106.8
C830	4030011210	S.CER GRM31M2C2H330JV01L (GRM42-6 CH)	B	22.5/17.1
C831	4030006880	S.CER C1608 JB 1H 472K-T	B	8.1/110.4
C832	4030006880	S.CER C1608 JB 1H 472K-T	B	51.6/95.5
C833	4030011730	S.CER GRM31M2C2H101JV01L (GRM42-6 CH)	B	27.6/17.1
C835	4030012480	S.CER GRM31M2C2H121JV01L (GRM42-6 CH)	B	16.7/107.2
C836	4030012480	S.CER GRM31M2C2H121JV01L (GRM42-6 CH)	B	12.6/107.9
C837	4030012480	S.CER GRM31M2C2H121JV01L (GRM42-6 CH)	B	12.6/105.8
C840	4030011600	S.CER C1608 JB 1E 104K-T	B	42.8/97.3
C841	4030006880	S.CER C1608 JB 1H 472K-T	B	46.1/98.5
C842	4030011730	S.CER GRM31M2C2H101JV01L (GRM42-6 CH)	B	39.0/106.8
C843	4010008160	CER HM13SJ SL 431J 500V		
C844	4030011730	S.CER GRM31M2C2H101JV01L (GRM42-6 CH)	B	25.9/102.9
C845	4030014460	S.CER GRM31M2C2H820JV01L (GRM42-6 CH)	B	19.7/91.9
C846	4010005370	CER HM11SJ SL 331J 500V		
C847	4010005930	CER HM11SJ SL 391J 500V		
C848	4030011190	S.CER GRM31M2C2H270JV01L (GRM42-6 CH)	B	12.6/98.3
C849	4030011180	S.CER GRM31M2C2H220JV01L (GRM42-6 CH)	B	12.6/96.2
C850	4010005930	CER HM11SJ SL 391J 500V		
C851	4030012480	S.CER GRM31M2C2H121JV01L (GRM42-6 CH)	B	20.3/112.1
C852	4030006880	S.CER C1608 JB 1H 472K-T	T	5.3/90.6
C853	4030011600	S.CER C1608 JB 1E 104K-T	T	2.6/90.6
C854	4030006880	S.CER C1608 JB 1H 472K-T	B	7.8/92.7
C855	4030011730	S.CER GRM31M2C2H101JV01L (GRM42-6 CH)	B	28.0/104.9
C856	4030011510	S.CER GRM31M2C2H560JV01L (GRM42-6 CH)	B	31.2/105.5
C857	4030012480	S.CER GRM31M2C2H121JV01L (GRM42-6 CH)	B	43.1/108.4
C858	4030011730	S.CER GRM31M2C2H101JV01L (GRM42-6 CH)	B	20.3/110.0
C860	4030011600	S.CER C1608 JB 1E 104K-T	B	43.4/83.8
C861	4030006880	S.CER C1608 JB 1H 472K-T	B	46.6/83.8
C863	4030011270	S.CER GRM31M2C2H200JV01L (GRM42-6 CH)	B	37.5/93.5
C864	4030011510	S.CER GRM31M2C2H560JV01L (GRM42-6 CH)	B	28.5/82.6
C865	4030011110	S.CER GRM31M2C2H9R0DV01L (GRM42-6 CH)	B	29.5/78.6
C866	4030011230	S.CER GRM31M2C2H390JV01L (GRM42-6 CH)	B	24.5/78.1
C868	4030011240	S.CER GRM31M2C2H470JV01L (GRM42-6 CH)	B	26.9/78.6

M.=Mounted side (T: Mounted on the Top side, B: Mounted on the Bottom side) S.=Surface mount

[PA UNIT]

REF NO.	PARTS NO.	DESCRIPTION	M.	H/V LOCATION
C869	4030011180	S.CER GRM31M2C2H220JV01L (GRM42-6 CH)	B	10.3/83.6
C870	4030011190	S.CER GRM31M2C2H270JV01L (GRM42-6 CH)	B	17.0/77.7
C871	4030006880	S.CER C1608 JB 1H 472K-T	T	5.2/74.5
C872	4030011600	S.CER C1608 JB 1E 104K-T	T	2.5/74.5
C873	4030011070	S.CER GRM31M2C2H5R0CY21L (GRM42-6 CH)	B	33.2/92.6
C874	4030006880	S.CER C1608 JB 1H 472K-T	B	9.0/74.5
C876	4030011160	S.CER GRM31M2C2H150JV01L (GRM42-6 CH)	B	22.1/77.5
C880	4030011600	S.CER C1608 JB 1E 104K-T	B	43.4/69.1
C881	4030006880	S.CER C1608 JB 1H 472K-T	B	47.0/69.1
C882	4010007590	CER HM15SJ SL 681J 500V		
C883	4010007590	CER HM15SJ SL 681J 500V		
C884	4010005930	CER HM11SJ SL 391J 500V		
C885	4320000320	DIP DM20C 222J5		
C886	4030012480	S.CER GRM31M2C2H121JV01L (GRM42-6 CH)	B	31.5/57.2
C887	4030011730	S.CER GRM31M2C2H101JV01L (GRM42-6 CH)	B	33.9/57.2
C889	4030014460	S.CER GRM31M2C2H820JV01L (GRM42-6 CH)	B	18.0/65.3
C890	4320001250	DIP DM19C 162J5		
C893	4030006880	S.CER C1608 JB 1H 472K-T	T	5.3/58.4
C894	4030011600	S.CER C1608 JB 1E 104K-T	T	2.6/58.4
C900	4030011600	S.CER C1608 JB 1E 104K-T	B	44.1/54.4
C901	4030006880	S.CER C1608 JB 1H 472K-T	B	46.9/54.4
C902	4010005870	CER HM95SJ SL 221J 500V		
C903	4030011190	S.CER GRM31M2C2H270JV01L (GRM42-6 CH)	B	30.9/42.7
C904	4030014460	S.CER GRM31M2C2H820JV01L (GRM42-6 CH)	B	28.4/42.7
C905	4010005870	CER HM95SJ SL 221J 500V		
C906	4030011510	S.CER GRM31M2C2H560JV01L (GRM42-6 CH)	B	17.0/44.0
C907	4030011510	S.CER GRM31M2C2H560JV01L (GRM42-6 CH)	B	10.8/49.5
C908	4030006880	S.CER C1608 JB 1H 472K-T	T	5.3/42.2
C909	4030011600	S.CER C1608 JB 1E 104K-T	T	2.6/42.2
C920	4030011600	S.CER C1608 JB 1E 104K-T	B	43.2/25.1
C921	4030006880	S.CER C1608 JB 1H 472K-T	B	47.1/25.4
C922	4010007590	CER HM15SJ SL 681J 500V		
C923	4030011730	S.CER GRM31M2C2H101JV01L (GRM42-6 CH)	B	31.4/27.3
C924	4010006410	CER HM13SJ SL 471J 500V		
C925	4030014460	S.CER GRM31M2C2H820JV01L (GRM42-6 CH)	B	15.8/29.5
C926	4010006410	CER HM13SJ SL 471J 500V		
C927	4010005930	CER HM11SJ SL 391J 500V		
C928	4010005930	CER HM11SJ SL 391J 500V		
C929	4030006880	S.CER C1608 JB 1H 472K-T	T	5.3/25.9
C930	4030011600	S.CER C1608 JB 1E 104K-T	T	2.6/25.9
C931	4030014460	S.CER GRM31M2C2H820JV01L (GRM42-6 CH)	B	34.1/27.3
C932	4030011730	S.CER GRM31M2C2H101JV01L (GRM42-6 CH)	B	33.3/32.4
C933	4030011730	S.CER GRM31M2C2H101JV01L (GRM42-6 CH)	B	29.7/30.9
C940	4030011600	S.CER C1608 JB 1E 104K-T	B	43.6/11.1
C941	4030006880	S.CER C1608 JB 1H 472K-T	B	43.6/14.2
C942	4030014460	S.CER GRM31M2C2H820JV01L (GRM42-6 CH)	B	39.5/119.2
C943	4030011210	S.CER GRM31M2C2H330JV01L (GRM42-6 CH)	B	28.9/111.7
C944	4030014460	S.CER GRM31M2C2H820JV01L (GRM42-6 CH)	B	24.7/118.4
C945	4030011170	S.CER GRM31M2C2H180JV01L (GRM42-6 CH)	B	16.5/118.1
C947	4030006880	S.CER C1608 JB 1H 472K-T	T	5.3/9.9
C948	4030011600	S.CER C1608 JB 1E 104K-T	T	2.6/9.9
C949	4030011050	S.CER GRM31M3C2H3R0CY21L (GRM42-6 CJ)	B	28.9/109.6
C960	4030010760	S.CER C1608 CH 1H 331J-T	T	18.2/130.2
C961	4030011600	S.CER C1608 JB 1E 104K-T	B	45.1/134.1
C962	4030006880	S.CER C1608 JB 1H 472K-T	B	39.0/137.9
C963	4030006880	S.CER C1608 JB 1H 472K-T	B	38.7/126.3
C964	4610002120	S.TRI TZB4Z100EB10R00 (TZBX4Z100BE110)	T	3.3/126.6
C966	4030006880	S.CER C1608 JB 1H 472K-T	B	21.3/131.2
C968	4030011340	S.CER C1608 CH 1H 471J-T	B	31.0/130.6
C969	4030011340	S.CER C1608 CH 1H 471J-T	B	31.0/133.7
C970	4030010760	S.CER C1608 CH 1H 331J-T	B	22.0/132.8
C971	4030011340	S.CER C1608 CH 1H 471J-T	B	35.8/133.7
C972	4030011790	S.CER GRM55RF52A684ZD01L (GRM44-1)	B	3.4/136.4
C973	4030007090	S.CER C1608 CH 1H 470J-T	B	8.4/129.8
C979	4030006880	S.CER C1608 JB 1H 472K-T	T	51.8/38.6
C987	4030006880	S.CER C1608 JB 1H 472K-T	B	28.9/3.3
C988	4030006880	S.CER C1608 JB 1H 472K-T	B	26.3/3.3
C989	4030006880	S.CER C1608 JB 1H 472K-T	B	25.0/2.6
C990	4030006880	S.CER C1608 JB 1H 472K-T	T	20.6/3.0
C991	4030006880	S.CER C1608 JB 1H 472K-T	T	20.6/4.2
C992	4030006880	S.CER C1608 JB 1H 472K-T	T	20.6/5.4
C993	4030006880	S.CER C1608 JB 1H 472K-T	T	20.6/6.6
C994	4030011600	S.CER C1608 JB 1E 104K-T	B	29.5/6.2
C995	4030006880	S.CER C1608 JB 1H 472K-T	B	23.7/3.4
C996	4030007090	S.CER C1608 CH 1H 470J-T	T	20.6/9.0
C997	4030007090	S.CER C1608 CH 1H 470J-T	T	20.6/7.8
C998	4030007090	S.CER C1608 CH 1H 470J-T	T	20.6/10.2
C999	4030006860	S.CER C1608 JB 1H 102K-T	T	56.9/9.5
C1000	4030006860	S.CER C1608 JB 1H 102K-T	B	55.6/5.1
C1001	4030011600	S.CER C1608 JB 1E 104K-T	B	51.7/1.7
C1002	4030006880	S.CER C1608 JB 1H 472K-T	B	27.6/2.6
C1003	4030011600	S.CER C1608 JB 1E 104K-T	T	49.8/7.6

Eqv.= This component is equivalent to the REF No. component listed above, and may be substituted on parts orders and repairs.

[PA UNIT]

REF NO.	PARTS NO.	DESCRIPTION	M.	H/V LOCATION
C1004	4030011510	S.CER GRM31M2C2H560JV01L (GRM42-6 CH)	B	39.9/21.9
C1005	4030011550	S.CER GRM31M2C2H680JV01L (GRM42-6 CH)	B	16.8/91.9
C1006	4030014460	S.CER GRM31M2C2H820JV01L (GRM42-6 CH)	B	39.0/109.2
C1007	4030011550	S.CER GRM31M2C2H680JV01L (GRM42-6 CH)	B	18.1/62.1
C1009	4030011510	S.CER GRM31M2C2H560JV01L (GRM42-6 CH)	B	20.6/118.7
C1010	4030014460	S.CER GRM31M2C2H820JV01L (GRM42-6 CH)	B	27.1/119.6
C1121	4010006410	CER HM13SJ SL 471J 500V		
RL701	6330001550	REL JV-12-KT		
RL801	6330001721	REL ATN207-K1		
RL820	6330001721	REL ATN207-K1		
RL821	6330001721	REL ATN207-K1		
RL840	6330001721	REL ATN207-K1		
RL841	6330001721	REL ATN207-K1		
RL860	6330001721	REL ATN207-K1		
RL861	6330001721	REL ATN207-K1		
RL880	6330001721	REL ATN207-K1		
RL881	6330001721	REL ATN207-K1		
RL900	6330001721	REL ATN207-K1		
RL901	6330001721	REL ATN207-K1		
RL920	6330001721	REL ATN207-K1		
RL921	6330001721	REL ATN207-K1		
RL940	6330001721	REL ATN207-K1		
RL941	6330001721	REL ATN207-K1		
J2	6510023512	S.CON 28FLT-SM2-TB(LF)(SN)(M)	T	80.1/6.0
J980	6510023512	S.CON 28FLT-SM2-TB(LF)(SN)(M)	T	63.7/6.0
F1	5220000341	HOL FHA010-03F		
F2	5210000940	FUS 1205		
W701	8900013900	CAB OPC-1455		
W702	8900013910	CAB OPC-1456		
W801	7120000480	S.JUM MJP-0.4-T	B	8.3/101.0
W901	7120000480	S.JUM MJP-0.4-T	T	56.7/22.0
EP202	6910012350	S.BEA MMZ1608Y 102BT	B	136.0/51.4
EP703	6910012350	S.BEA MMZ1608Y 102BT	B	142.6/13.9
EP741	6910012350	S.BEA MMZ1608Y 102BT	B	76.4/12.0
EP742	6910012350	S.BEA MMZ1608Y 102BT	B	77.8/11.3
EP743	6910012350	S.BEA MMZ1608Y 102BT	B	59.8/99.6
EP747	6910012350	S.BEA MMZ1608Y 102BT	T	65.1/9.7
EP748	6910012350	S.BEA MMZ1608Y 102BT	T	63.8/9.7
EP751	6910012350	S.BEA MMZ1608Y 102BT	T	74.1/9.6
EP752	6910012350	S.BEA MMZ1608Y 102BT	B	63.4/5.3
EP753	6910012350	S.BEA MMZ1608Y 102BT	T	66.4/9.7
EP754	6910012350	S.BEA MMZ1608Y 102BT	B	59.4/115.9
EP756	6910012350	S.BEA MMZ1608Y 102BT	T	68.6/2.6
EP758	6910012350	S.BEA MMZ1608Y 102BT	T	70.4/9.6
EP759	6910012350	S.BEA MMZ1608Y 102BT	T	69.1/9.6
EP760	6910012350	S.BEA MMZ1608Y 102BT	T	60.7/10.0
EP761	6910012350	S.BEA MMZ1608Y 102BT	T	62.6/9.7
EP762	6910012350	S.BEA MMZ1608Y 102BT	B	61.0/4.6
EP763	6910012350	S.BEA MMZ1608Y 102BT	B	63.4/105.7
EP767	6910012350	S.BEA MMZ1608Y 102BT	B	76.4/5.2
EP772	6910012350	S.BEA MMZ1608Y 102BT	T	96.5/3.8
EP774	6910012350	S.BEA MMZ1608Y 102BT	T	72.8/9.6
EP775	6910012350	S.BEA MMZ1608Y 102BT	B	74.8/5.2
EP776	6910012350	S.BEA MMZ1608Y 102BT	B	73.2/5.2
EP777	6910012350	S.BEA MMZ1608Y 102BT	B	70.0/5.2
EP778	6910012350	S.BEA MMZ1608Y 102BT	B	71.6/5.2
EP779	6910012350	S.BEA MMZ1608Y 102BT	B	68.2/5.3

M.=Mounted side (T: Mounted on the Top side, B: Mounted on the Bottom side) S.=Surface mount

[DRIVER UNIT]

REF NO.	PARTS NO.	DESCRIPTION	M.	H/V LOCATION
Q504	1590003061	S.FET PD55015-E	T	20.0/9.7
R102	7070000271	RES ERG1SJ 101 (100)		
R103	7030000020	S.RES MCR10EZJH 1 (010)	T	14.3/4.1
C101	4030004750	S.CER C2012 JB 1H 103K-T	T	24.6/18.2
C102	4030011230	S.CER GRM31M2C2H390JV01L (GRM42-6 CH)	T	10.2/4.3
J101	6910016830	CON IMSA-9230B-1-04Z149-PT1		
J102	6910016830	CON IMSA-9230B-1-04Z149-PT1		
J103	6910016830	CON IMSA-9230B-1-04Z149-PT1		
J104	6910016830	CON IMSA-9230B-1-04Z149-PT1		
J107	6910016830	CON IMSA-9230B-1-04Z149-PT1		

[DISPLAY UNIT]

REF NO.	PARTS NO.	DESCRIPTION	M.	H/V LOCATION
IC1	6910016731	S.DC XC9504B092AR-G	B	44.5/9.4
IC101	1180001072	S.IC TA7805F(TE16L1NQ)	B	90.3/6.9
IC151	1180002202	S.IC RN5RZ33BA-TR-FE	B	99.9/4.8
IC301	1110002751	S.IC TA75S01F(TE85RF)	B	113.8/7.6
IC506	1120003010	S.IC AN2533FH-V	B	69.0/38.5
IC651	1110005420	S.IC BA15532F-E2	B	4.1/25.6
IC2003	1140013140	S.IC HD643380205B68HV(SX-2427C)	B	93.0/26.3
IC2007	1110005822	S.IC R3112N281A-TR-FE	B	108.7/46.9
Q1	1550000090	S.FET RSQ035P03TR	B	39.5/9.9
Q51	1560001330	S.FET RSR025N03	B	52.1/10.6
Q301	1560001290	S.FET 2SK3065 T100	T	110.8/31.4
Q302	1590003940	S.TRA RN1105(TE85LF)	T	116.7/10.2
Q303	1590004030	S.TRA KRX204U-RTK/P	T	113.1/11.6
Q651	1590001650	S.TRA XP4601(TX)	B	10.6/28.8
Q652	1590001650	S.TRA XP4601(TX)	B	11.1/20.6
Q653	1590001650	S.TRA XP4601(TX)	B	10.7/26.2
Q654	1590001650	S.TRA XP4601(TX)	B	11.1/17.0
Q701	1530004140	S.TRA L2SC4081RT1G <SLVJ>	T	19.1/50.3
Q721	1530004140	S.TRA L2SC4081RT1G <SLVJ>	T	22.0/5.9
Q741	1530004140	S.TRA L2SC4081RT1G <SLVJ>	T	94.0/50.1
Q761	1530004140	S.TRA L2SC4081RT1G <SLVJ>	T	104.2/50.1
Q771	1530004140	S.TRA L2SC4081RT1G <SLVJ>	T	18.4/25.2
Q781	1530004140	S.TRA L2SC4081RT1G <SLVJ>	T	5.3/23.6
Q802	1520000460	S.TRA 2SB1132 T100 R	B	58.8/21.6
Q851	1590004770	S.FET CPH3455-TL-H	B	39.9/18.4
Q2001	1590003940	S.TRA RN1105(TE85LF)	B	81.6/23.8
Q2002	1590001870	S.TRA DTA114EE TL	B	80.2/29.8
Q2003	1590003480	S.TRA DTC114TE TL	B	82.2/32.3
D1	1790000971	S.DIO MA2J7290GL	B	36.9/10.2
D51	1750000731	S.DIO MA2SD100GL	B	51.0/8.1
D301	1790001251	S.DIO MA2S1110GL	B	111.1/32.1
D302	1790001521	S.ZEN MAZ8075GLL	B	109.9/7.6
D601	1750000951	S.DIO MA2J7320GL	B	51.6/39.9
D602	1750000951	S.DIO MA2J7320GL	B	53.4/39.9
D801	1730002341	S.ZEN MAZ8047GML	B	35.0/40.5
D802	1730002341	S.ZEN MAZ8047GML	B	39.8/25.9
D803	1730002341	S.ZEN MAZ8047GML	B	39.5/22.9
D804	1730002341	S.ZEN MAZ8047GML	B	42.1/22.9
D2001	1750000951	S.DIO MA2J7320GL	T	107.5/26.5
D2002	1790001670	S.DIO RB706F-40T106	B	76.6/16.9
D2003	1790001670	S.DIO RB706F-40T106	T	116.5/36.8
D2004	1750000370	S.DIO DA221 TL	T	100.6/41.8
D2005	1750000370	S.DIO DA221 TL	B	101.7/42.8
D2006	1750000370	S.DIO DA221 TL	B	107.3/5.9
X501	6050012150	S.XTA CR-806 SMD-49TA		
		4.433619 MHz<KDS>	[EUR]	B 87.0/43.5
	6050012150	S.XTA CR-806 SMD-49TA		
		4.433619 MHz<KDS>	[FRA]	B
	6050012150	S.XTA CR-806 SMD-49TA		
		4.433619 MHz<KDS>	[ESP]	B
	6050012140	S.XTA CR-805 SMD-49TA		
		3.579545 MHz<KDS>	[USA]	B
	6050012150	S.XTA CR-806 SMD-49TA		
		4.433619 MHz<KDS>	[ITR]	B
	6050012150	S.XTA CR-806 SMD-49TA		
		4.433619 MHz<KDS>	[UK]	B
	6050012140	S.XTA CR-805 SMD-49TA		
		3.579545 MHz<KDS>	[KOR]	B
	6050012150	S.XTA CR-806 SMD-49TA		
		4.433619 MHz<KDS>	[AUS]	B
	6050012150	S.XTA CR-806 SMD-49TA		
		4.433619 MHz<KDS>	[CHN]	B
X2001	6050011550	S.XTA CR-747 SMD-49TA		
		9.8304 MHz<KDS>		B 106.5/27.0
L1	6190001561	S.COI CDRH5D18NP-101NCI	B	68.4/6.4
L2	6190001561	S.COI CDRH5D18NP-101NCI	B	34.6/5.2
L3	6200002041	S.COI NLV25T-101J	B	30.7/10.4
L51	6190001561	S.COI CDRH5D18NP-101NCI	B	56.0/6.2
L53	6200002041	S.COI NLV25T-101J	B	60.9/11.0
L101	6200001831	S.COI NLV32T-100J	B	96.0/11.6
L151	6200001831	S.COI NLV32T-100J	B	96.0/8.6
L152	6200001831	S.COI NLV32T-100J	B	100.6/11.4
L251	6200003950	S.COI HF50ACC 322513-T	B	145.8/44.0
L252	6200003950	S.COI HF50ACC 322513-T	B	145.2/50.9
L301	6200002041	S.COI NLV25T-101J	B	109.7/16.8
L302	6200005011	S.COI NLV25T-100J	T	112.6/24.1
L303	6200002041	S.COI NLV25T-101J	T	112.1/20.4
L306	6200003261	S.COI NLV32T-101J	T	109.9/25.6
L307	6200002041	S.COI NLV25T-101J	T	115.4/26.6
L309	6200002041	S.COI NLV25T-101J	T	115.4/24.1
L310	6200002041	S.COI NLV25T-101J	T	115.5/21.6
L312	6200002041	S.COI NLV25T-101J	T	115.5/19.1
L313	6200002041	S.COI NLV25T-101J	T	115.8/16.3
L505	6200005521	S.COI NLV25T-470J	B	71.2/47.9
L506	6200005011	S.COI NLV25T-100J	B	68.0/20.2
L507	6200005011	S.COI NLV25T-100J	B	50.3/29.0
L508	6200005011	S.COI NLV25T-100J	B	49.3/24.4
L509	6200005011	S.COI NLV25T-100J	B	17.4/35.7
L601	6200002041	S.COI NLV25T-101J	B	70.6/25.2
L602	6200005011	S.COI NLV25T-100J	B	53.5/36.2
L603	6200005011	S.COI NLV25T-100J	B	51.0/43.3
L604	6200005011	S.COI NLV25T-100J	B	53.5/43.3
L605	6200005011	S.COI NLV25T-100J	B	50.9/36.2
L651	6200002041	S.COI NLV25T-101J	B	19.1/42.8
L701	6200002041	S.COI NLV25T-101J	B	21.1/37.5
L702	6200002041	S.COI NLV25T-101J	B	65.4/11.0
L703	6200002041	S.COI NLV25T-101J	B	28.0/11.3

Eqv.= This component is equivalent to the REF No. component listed above, and may be substituted on parts orders and repairs.

M.=Mounted side (T: Mounted on the Top side, B: Mounted on the Bottom side) S.=Surface mount

[DISPLAY UNIT]

REF NO.	PARTS NO.	DESCRIPTION	M.	H/V LOCATION
L801	6200005011	S.COI NLV25T-100J	B	63.5/17.0
L802	6200002041	S.COI NLV25T-101J	B	19.1/47.5
L851	6200003950	S.COI HF50ACC 322513-T	B	33.2/17.2
L852	6200003950	S.COI HF50ACC 322513-T	B	35.0/21.4
L853	6200002041	S.COI NLV25T-101J	B	34.4/26.6
L854	6200002041	S.COI NLV25T-101J	B	34.4/24.1
L855	6200003950	S.COI HF50ACC 322513-T	B	36.5/17.2
R1	7030008141	S.RES ERA3YKD 224V (220K)	B	33.5/9.7
R2	7030005671	S.RES ERA3YKD 393V (39K)	B	33.5/11.6
R3	7030008051	S.RES ERA3YKD 184V (180K)	B	42.6/6.4
R4	7030005050	S.RES ERJ2GEJ 103 X (10K)	B	40.9/6.8
R5	7030005050	S.RES ERJ2GEJ 103 X (10K)	B	40.9/7.7
R51	7030008141	S.RES ERA3YKD 224V (220K)	B	49.8/10.8
R52	7030007911	S.RES ERA3YKD 563V (56K)	B	48.6/10.8
R53	7030006561	S.RES ERA3YED 223V (22K)	B	46.6/11.8
R54	7030005050	S.RES ERJ2GEJ 103 X (10K)	B	48.0/8.4
R55	7030005050	S.RES ERJ2GEJ 103 X (10K)	B	48.9/8.4
R201	7030010040	S.RES ERJ2GEJ-JPW	B	109.7/38.1
R202	7030010040	S.RES ERJ2GEJ-JPW	B	109.7/39.1
R251	7030005120	S.RES ERJ2GEJ 102 X (1K)	B	136.6/49.6
R252	7030000300	S.RES MCR10EZHJ 220 (221)	B	133.9/47.3
R253	7030000300	S.RES MCR10EZHJ 220 (221)	B	141.3/51.5
R254	7030000300	S.RES MCR10EZHJ 220 (221)	B	133.9/49.1
R255	7030000300	S.RES MCR10EZHJ 220 (221)	T	142.6/51.4
R301	7030005120	S.RES ERJ2GEJ 102 X (1K)	B	113.3/32.1
R302	7030005050	S.RES ERJ2GEJ 103 X (10K)	T	114.0/30.5
R303	7030005120	S.RES ERJ2GEJ 102 X (1K)	B	111.1/33.4
R304	7030007300	S.RES ERJ2GEJ 332 X (3.3K)	B	112.0/33.4
R305	7030007300	S.RES ERJ2GEJ 332 X (3.3K)	B	113.2/33.0
R306	7030005120	S.RES ERJ2GEJ 102 X (1K)	T	114.9/11.0
R307	7030005050	S.RES ERJ2GEJ 103 X (10K)	B	111.3/8.4
R308	7030005230	S.RES ERJ2GEJ 334 X (330K)	B	113.8/5.4
R309	7030005310	S.RES ERJ2GEJ 124 X (120K)	B	112.0/5.4
R310	7030008010	S.RES ERJ2GEJ 123 X (12K)	B	110.2/5.4
R521	7030008370	S.RES ERJ2GEJ 561 X (560)	B	61.9/46.3
R522	7030010040	S.RES ERJ2GEJ-JPW	B	65.3/47.4
R523	7030010040	S.RES ERJ2GEJ-JPW	B	65.4/48.7
R524	7030010900	S.RES ERJ3GEYJ 750 V (75)	B	63.2/49.0
R528	7030010040	S.RES ERJ2GEJ-JPW	B	60.8/42.7
R529	7030005050	S.RES ERJ2GEJ 103 X (10K)	B	58.6/43.9
R530	7030005080	S.RES ERJ2GEJ 823 X (82K)	B	60.8/43.7
R531	7030009290	S.RES ERJ2GEJ 562 X (5.6K)	B	76.3/43.0
R532	7030005050	S.RES ERJ2GEJ 103 X (10K)	B	60.8/37.2
R533	7030010040	S.RES ERJ2GEJ-JPW	B	56.6/32.3
R534	7030010040	S.RES ERJ2GEJ-JPW	B	60.8/36.0
R536	7030010040	S.RES ERJ2GEJ-JPW	B	62.6/29.0
R537	7030010040	S.RES ERJ2GEJ-JPW	B	64.6/29.0
R538	7030010040	S.RES ERJ2GEJ-JPW	B	66.6/29.0
R539	7030005720	S.RES ERJ2GEJ 563 X (56K)	B	69.7/29.0
R540	7030010040	S.RES ERJ2GEJ-JPW	B	68.6/29.0
R541	7310004650	S.TRI EVM-2WSX80 B53 (502)	B	53.3/49.3
R544	7030010040	S.RES ERJ2GEJ-JPW	B	60.8/39.6
R545	7030005720	S.RES ERJ2GEJ 563 X (56K)	B	60.8/32.0
R546	7030010040	S.RES ERJ2GEJ-JPW	B	60.8/34.0
R547	7030010040	S.RES ERJ2GEJ-JPW	B	59.2/34.8
R548	7030010040	S.RES ERJ2GEJ-JPW	B	60.8/33.0
R549	7030010040	S.RES ERJ2GEJ-JPW	B	63.6/29.0
R550	7030010040	S.RES ERJ2GEJ-JPW	B	65.6/29.0
R551	7030010040	S.RES ERJ2GEJ-JPW	B	67.6/29.0
R553	7030010040	S.RES ERJ2GEJ-JPW	B	59.5/43.9
R601	7030008410	S.RES ERJ2GEJ 392 X (3.9K)	B	72.7/24.9
R602	7030008410	S.RES ERJ2GEJ 392 X (3.9K)	B	74.5/24.9
R603	7030008410	S.RES ERJ2GEJ 392 X (3.9K)	B	75.4/24.9
R604	7030008410	S.RES ERJ2GEJ 392 X (3.9K)	B	77.2/24.9
R605	7030008410	S.RES ERJ2GEJ 392 X (3.9K)	B	75.0/20.2
R606	7030008410	S.RES ERJ2GEJ 392 X (3.9K)	B	76.3/24.9
R608	7030010040	S.RES ERJ2GEJ-JPW	B	48.8/36.8
R609	7030005040	S.RES ERJ2GEJ 472 X (4.7K)	B	48.5/44.4
R610	7030010040	S.RES ERJ2GEJ-JPW	B	48.8/41.7
R612	7030005040	S.RES ERJ2GEJ 472 X (4.7K)	B	48.8/42.6
R613	7030003470	S.RES ERJ3GEYJ 182 V (1.8K)	B	52.6/46.1
R614	7030003470	S.RES ERJ3GEYJ 182 V (1.8K)	B	50.0/46.3
R651	7030005050	S.RES ERJ2GEJ 103 X (10K)	B	5.5/19.7
R652	7030005220	S.RES ERJ2GEJ 223 X (22K)	B	0.8/25.7
R653	7030005060	S.RES ERJ2GEJ 333 X (33K)	B	5.5/21.5
R654	7030005070	S.RES ERJ2GEJ 683 X (68K)	B	0.8/23.9
R655	7030005090	S.RES ERJ2GEJ 104 X (100K)	B	4.1/30.7
R656	7030005110	S.RES ERJ2GEJ 224 X (220K)	B	0.8/27.4
R657	7030005060	S.RES ERJ2GEJ 333 X (33K)	B	1.8/30.3
R658	7030005090	S.RES ERJ2GEJ 104 X (100K)	B	4.1/29.8
R659	7030003600	S.RES ERJ3GEYJ 223 V (22K)	B	8.4/28.5
R660	7030005720	S.RES ERJ2GEJ 563 X (56K)	B	13.3/30.0
R661	7030005220	S.RES ERJ2GEJ 223 X (22K)	B	13.7/27.2
R662	7030007350	S.RES ERJ2GEJ 393 X (39K)	B	13.7/28.8
R663	7030005220	S.RES ERJ2GEJ 223 X (22K)	B	13.2/20.6
R664	7030007340	S.RES ERJ2GEJ 153 X (15K)	B	5.7/29.8
R665	7030003600	S.RES ERJ3GEYJ 223 V (22K)	B	8.9/20.6
R666	7030004980	S.RES ERJ2GEJ 101 X (100)	B	13.1/25.3
R667	7030004980	S.RES ERJ2GEJ 101 X (100)	B	11.1/18.8
R668	7030004980	S.RES ERJ2GEJ 101 X (100)	B	9.8/24.2
R669	7030004980	S.RES ERJ2GEJ 101 X (100)	B	13.6/16.2
R701	7030004990	S.RES ERJ2GEJ 221 X (220)	T	18.5/48.0
R702	7030007280	S.RES ERJ2GEJ 331 X (330)	T	19.8/48.0
R703	7030007290	S.RES ERJ2GEJ 222 X (2.2K)	T	25.1/41.0
R704	7030005040	S.RES ERJ2GEJ 472 X (4.7K)	T	16.6/17.3
R705	7030007340	S.RES ERJ2GEJ 153 X (15K)	T	18.7/6.4
R721	7030004990	S.RES ERJ2GEJ 221 X (220)	T	20.2/6.3
R722	7030007280	S.RES ERJ2GEJ 331 X (330)	T	23.8/5.7
R723	7030003480	S.RES ERJ3GEYJ 222 V (2.2K)	T	47.5/2.4
R724	7030003520	S.RES ERJ3GEYJ 472 V (4.7K)	T	61.8/2.4
R725	7030003580	S.RES ERJ3GEYJ 153 V (15K)	T	75.9/2.4
R741	7030004990	S.RES ERJ2GEJ 221 X (220)	T	92.3/49.8
R742	7030007280	S.RES ERJ2GEJ 331 X (330)	T	95.8/49.7

Eqv.= This component is equivalent to the REF No. component listed above, and may be substituted on parts orders and repairs.

DISPLAY UNIT]

REF NO.	PARTS NO.	DESCRIPTION	M.	H/V LOCATION
R743	7030007290	S.RES ERJ2GEJ 222 X (2.2K)	T	102.1/35.0
R744	7030005040	S.RES ERJ2GEJ 472 X (4.7K)	T	102.1/25.5
R745	7030007340	S.RES ERJ2GEJ 153 X (15K)	T	100.6/8.6
R761	7030004990	S.RES ERJ2GEJ 221 X (220)	T	103.1/48.2
R762	7030007280	S.RES ERJ2GEJ 331 X (330)	T	104.9/47.9
R771	7030004990	S.RES ERJ2GEJ 221 X (220)	T	18.7/28.9
R772	7030007280	S.RES ERJ2GEJ 331 X (330)	T	18.1/29.9
R781	7030004990	S.RES ERJ2GEJ 221 X (220)	T	3.5/22.4
R782	7030007280	S.RES ERJ2GEJ 331 X (330)	T	3.5/24.2
R801	7030005240	S.RES ERJ2GEJ 473 X (47K)	B	62.1/21.8
R802	7030007270	S.RES ERJ2GEJ 151 X (150)	B	62.1/20.0
R803	7030005120	S.RES ERJ2GEJ 102 X (1K)	B	62.1/23.6
R2002	7030005240	S.RES ERJ2GEJ 473 X (47K)	T	110.4/40.7
R2003	7030005050	S.RES ERJ2GEJ 103 X (10K)	T	24.6/24.2
R2004	7030005050	S.RES ERJ2GEJ 103 X (10K)	T	24.6/26.3
R2005	7030005050	S.RES ERJ2GEJ 103 X (10K)	T	24.6/23.3
R2006	7030005050	S.RES ERJ2GEJ 103 X (10K)	T	24.6/25.3
R2007	7030007290	S.RES ERJ2GEJ 222 X (2.2K)	B	107.6/24.5
R2008	7030005220	S.RES ERJ2GEJ 223 X (22K)	T	78.3/18.4
R2009	7030005240	S.RES ERJ2GEJ 473 X (47K)	T	107.9/33.1
R2010	7030005090	S.RES ERJ2GEJ 104 X (100K)	B	79.7/16.9
R2011	7030005160	S.RES ERJ2GEJ 105 X (1M)	B	103.3/26.9
R2012	7030008010	S.RES ERJ2GEJ 123 X (12K)	B	103.3/37.3
R2013	7030005240	S.RES ERJ2GEJ 473 X (47K)	B	96.7/23.9
R2014	7030005290	S.RES ERJ2GEJ 682 X (6.8K)	T	24.1/41.0
R2015	7030005050	S.RES ERJ2GEJ 103 X (10K)	B	106.0/44.6
R2016	7030005240	S.RES ERJ2GEJ 473 X (47K)	B	92.2/37.9
R2017	7030005290	S.RES ERJ2GEJ 682 X (6.8K)	T	33.4/3.7
R2018	7030005290	S.RES ERJ2GEJ 682 X (6.8K)	T	102.2/41.8
R2019	7030005240	S.RES ERJ2GEJ 473 X (47K)	B	84.9/33.9
R2020	7030003450	S.RES ERJ3GEYJ 122 V (1.2K)	B	91.3/43.1
R2021	7030005240	S.RES ERJ2GEJ 473 X (47K)	B	97.1/40.8
R2022	7030005240	S.RES ERJ2GEJ 473 X (47K)	B	92.3/42.3
R2023	7030005240	S.RES ERJ2GEJ 473 X (47K)	B	100.1/42.8
R2024	7030005240	S.RES ERJ2GEJ 473 X (47K)	B	94.3/42.3
R2025	7030005240	S.RES ERJ2GEJ 473 X (47K)	B	93.3/42.3
R2026	7030005240	S.RES ERJ2GEJ 473 X (47K)	B	72.4/16.8
R2027	7030005240	S.RES ERJ2GEJ 473 X (47K)	B	70.6/16.9
R2028	7030005240	S.RES ERJ2GEJ 473 X (47K)	B	98.9/42.8
R2029	7030005240	S.RES ERJ2GEJ 473 X (47K)	B	73.5/16.8
R2030	7030007270	S.RES ERJ2GEJ 151 X (150)	T	108.0/11.8
R2031	7030007280	S.RES ERJ2GEJ 331 X (330)	T	108.8/40.2
R2033	7030007270	S.RES ERJ2GEJ 151 X (150)	T	19.5/20.3
R2034	7030005120	S.RES ERJ2GEJ 102 X (1K)	B	32.2/28.3
R2035	7030005120	S.RES ERJ2GEJ 102 X (1K)	B	32.6/30.9
R2036	7030005240	S.RES ERJ2GEJ 473 X (47K)	B	94.9/37.9
R2037	7030005240	S.RES ERJ2GEJ 473 X (47K)	B	94.0/37.9
R2039	7030005240	S.RES ERJ2GEJ 473 X (47K)	T	107.6/23.6
R2040	7030007340	S.RES ERJ2GEJ 153 X (15K)	B	116.4/8.8
R2041	7030007340	S.RES ERJ2GEJ 153 X (15K)	B	116.3/7.7
R2042	7030005050	S.RES ERJ2GEJ 103 X (10K)	B	79.7/31.3
R2043	7030005090	S.RES ERJ2GEJ 104 X (100K)	B	82.0/30.4
C2	4030018960	S.CER C3216 JB 1C 106MT-N	B	62.2/7.0
C3	4030018960	S.CER C3216 JB 1C 106MT-N	B	77.0/9.8
C4	4030017420	S.CER C1005 CH 1H 470J-T	B	35.4/10.7
C6	4030018960	S.CER C3216 JB 1C 106MT-N	B	28.1/6.1
C8	4030018960	S.CER C3216 JB 1C 106MT-N	B	30.2/6.1
C9	4030018960	S.CER C3216 JB 1C 106MT-N	B	39.2/4.5
C51	4030017420	S.CER C1005 CH 1H 470J-T	B	49.8/8.4
C53	4030018960	S.CER C3216 JB 1C 106MT-N	B	51.6/4.4
C55	4030018960	S.CER C3216 JB 1C 106MT-N	B	56.3/11.1
C56	4030018960	S.CER C3216 JB 1C 106MT-N	B	61.9/3.6
C57	4030017420	S.CER C1608 JB 1A 105K-T	B	44.0/11.8
C101	4030018960	S.CER C3216 JB 1C 106MT-N	B	85.7/6.3
C102	4030018960	S.CER C3216 JB 1C 106MT-N	B	94.7/4.6
C103	4030016930	S.CER C1005 JB 1A 104K-T	B	91.1/12.2
C104	4030016930	S.CER C1005 JB 1A 104K-T	B	89.5/12.2
C151	4550007520	S.TAN F931A106MAABMA [EUR]	B	97.0/4.6
Eqv.	4550006250	S.TAN TEESVA 1A 106M8R [EUR]		
C151	4550006250	S.TAN TEESVA 1A 106M8R [FRA]	B	97.0/4.6
Eqv.	4550007520	S.TAN F931A106MAABMA [FRA]		
C151	4550006250	S.TAN TEESVA 1A 106M8R [ESP]	B	97.0/4.6
Eqv.	4550007520	S.TAN F931A106MAABMA [ESP]		
C151	4550007520	S.TAN F931A106MAABMA [USA]	B	97.0/4.6
Eqv.	4550006250	S.TAN TEESVA 1A 106M8R [USA]		
C151	4550006250	S.TAN TEESVA 1A 106M8R [ITR]	B	97.0/4.6
Eqv.	4550007520	S.TAN F931A106MAABMA [ITR]		
C151	4550007520	S.TAN F931A106MAABMA [UK]	B	97.0/4.6
Eqv.	4550006250	S.TAN TEESVA 1A 106		

[DISPLAY UNIT]

REF NO.	PARTS NO.	DESCRIPTION	M.	H/V LOCATION
C153	4030016930	S.CER C1005 JB 1A 104K-T	B	99.7/2.6
C154	4030016930	S.CER C1005 JB 1A 104K-T	B	99.6/9.3
C251	4030017730	S.CER C1005 JB 1H 471K-T	B	147.5/46.4
C252	4030017730	S.CER C1005 JB 1H 471K-T	B	146.5/48.3
C253	4030017730	S.CER C1005 JB 1H 471K-T	B	144.7/48.3
C254	4030017730	S.CER C1005 JB 1H 471K-T	B	144.4/46.4
C255	4030017490	S.CER C1608 JB 1A 105K-T	T	149.0/51.0
C256	4030017490	S.CER C1608 JB 1A 105K-T	B	134.2/45.8
C301	4030017780	S.CER C1005 JB 1H 472K-T	T	108.3/20.0
C302	4030017780	S.CER C1005 JB 1H 472K-T	T	108.2/28.8
C303	4030006880	S.CER C1608 JB 1H 472K-T	T	113.1/27.1
C304	4030017780	S.CER C1005 JB 1H 472K-T	B	113.3/33.9
C305	4030017780	S.CER C1005 JB 1H 472K-T	T	114.9/12.6
C306	4030017780	S.CER C1005 JB 1H 472K-T	B	113.8/4.4
C312	4030017780	S.CER C1005 JB 1H 472K-T	T	108.2/29.7
C315	4030017780	S.CER C1005 JB 1H 472K-T	B	25.2/20.0
C316	4030017780	S.CER C1005 JB 1H 472K-T	B	26.1/20.0
C317	4030017780	S.CER C1005 JB 1H 472K-T	B	27.0/20.0
C318	4030017780	S.CER C1005 JB 1H 472K-T	B	24.0/19.9
C319	4030017780	S.CER C1005 JB 1H 472K-T	B	27.2/32.5
C320	4030017780	S.CER C1005 JB 1H 472K-T	B	26.3/32.5
C321	4030017780	S.CER C1005 JB 1H 472K-T	B	25.6/31.2
C322	4030017780	S.CER C1005 JB 1H 472K-T	T	24.6/27.3
C501	4550008190	S.TAN F931C107MNC [EUR]	B	53.4/21.0
Eqv.	4550007140	S.TAN TEESVD 1C 107M12R [EUR]		
C501	4550007140	S.TAN TEESVD 1C 107M12R [FRA]	B	53.4/21.0
Eqv.	4550008190	S.TAN F931C107MNC [FRA]		
C501	4550007140	S.TAN TEESVD 1C 107M12R [ESP]	B	53.4/21.0
Eqv.	4550008190	S.TAN F931C107MNC [ESP]		
C501	4550008190	S.TAN F931C107MNC [USA]	B	53.4/21.0
Eqv.	4550007140	S.TAN TEESVD 1C 107M12R [USA]		
C501	4550007140	S.TAN TEESVD 1C 107M12R [ITR]	B	53.4/21.0
Eqv.	4550008190	S.TAN F931C107MNC [ITR]		
C501	4550008190	S.TAN F931C107MNC [UK]	B	53.4/21.0
Eqv.	4550007140	S.TAN TEESVD 1C 107M12R [UK]		
C501	4550007140	S.TAN TEESVD 1C 107M12R [KOR]	B	53.4/21.0
Eqv.	4550008190	S.TAN F931C107MNC [KOR]		
C501	4550007140	S.TAN TEESVD 1C 107M12R [AUS]	B	53.4/21.0
Eqv.	4550008190	S.TAN F931C107MNC [AUS]		
C501	4550008190	S.TAN F931C107MNC [CHN]	B	53.4/21.0
Eqv.	4550007140	S.TAN TEESVD 1C 107M12R [CHN]		
C502	4550008190	S.TAN F931C107MNC [EUR]	B	45.4/21.0
Eqv.	4550007140	S.TAN TEESVD 1C 107M12R [EUR]		
C502	4550007140	S.TAN TEESVD 1C 107M12R [FRA]	B	45.4/21.0
Eqv.	4550008190	S.TAN F931C107MNC [FRA]		
C502	4550007140	S.TAN TEESVD 1C 107M12R [ESP]	B	45.4/21.0
Eqv.	4550008190	S.TAN F931C107MNC [ESP]		
C502	4550008190	S.TAN F931C107MNC [USA]	B	45.4/21.0
Eqv.	4550007140	S.TAN TEESVD 1C 107M12R [USA]		
C502	4550007140	S.TAN TEESVD 1C 107M12R [ITR]	B	45.4/21.0
Eqv.	4550008190	S.TAN F931C107MNC [ITR]		
C502	4550008190	S.TAN F931C107MNC [UK]	B	45.4/21.0
Eqv.	4550007140	S.TAN TEESVD 1C 107M12R [UK]		
C502	4550007140	S.TAN TEESVD 1C 107M12R [KOR]	B	45.4/21.0
Eqv.	4550008190	S.TAN F931C107MNC [KOR]		
C502	4550007140	S.TAN TEESVD 1C 107M12R [AUS]	B	45.4/21.0
Eqv.	4550008190	S.TAN F931C107MNC [AUS]		
C502	4550008190	S.TAN F931C107MNC [CHN]	B	45.4/21.0
Eqv.	4550007140	S.TAN TEESVD 1C 107M12R [CHN]		
C513	4030016930	S.CER C1005 JB 1A 104K-T	B	64.3/47.4
C514	4030016930	S.CER C1005 JB 1A 104K-T	B	63.3/47.4
C515	4030017490	S.CER C1608 JB 1A 105K-T	B	61.5/44.9
C516	4030018910	S.CER C1608 JB 0J 475K-T	B	67.7/48.9
C517	4030017490	S.CER C1608 JB 1A 105K-T	B	75.6/47.9
C518	4030017650	S.CER C1005 CH 1H 270J-T [EUR]	B	73.4/47.4
	4030017650	S.CER C1005 CH 1H 270J-T [FRA]		
	4030017650	S.CER C1005 CH 1H 270J-T [ESP]		
	4030017670	S.CER C1005 CH 1H 390J-T [USA]		
	4030017650	S.CER C1005 CH 1H 270J-T [ITR]		
	4030017650	S.CER C1005 CH 1H 270J-T [UK]		
	4030017670	S.CER C1005 CH 1H 390J-T [KOR]		
	4030017650	S.CER C1005 CH 1H 270J-T [AUS]		
	4030017650	S.CER C1005 CH 1H 270J-T [CHN]		
C519	4030016930	S.CER C1005 JB 1A 104K-T	B	77.0/48.5
C520	4030016930	S.CER C1005 JB 1A 104K-T	B	74.4/47.4
C521	4030018960	S.CER C3216 JB 1C 106MT-N	B	65.7/20.6
C522	4030016930	S.CER C1005 JB 1A 104K-T	B	69.7/19.9
C523	4030018970	S.CER C3225 JB 1C 226MT-N	B	53.4/28.9
C524	4030017700	S.CER C1005 CH 1H 151J-T	B	59.0/42.7
C525	4030016930	S.CER C1005 JB 1A 104K-T	B	55.4/30.3
C526	4030018090	S.CER C1005 JB 1E 822K-T	B	59.2/35.8
C527	4030018100	S.CER C1005 JB 1H 681K-T	B	59.0/46.0
C528	4030017730	S.CER C1005 JB 1H 471K-T	B	59.0/45.1
C529	4030018970	S.CER C3225 JB 1C 226MT-N	B	58.4/40.0
C530	4030016930	S.CER C1005 JB 1A 104K-T	B	77.2/39.1
C531	4030018970	S.CER C3225 JB 1C 226MT-N	B	81.3/35.9
C532	4030016930	S.CER C1005 JB 1A 104K-T	B	77.2/36.6
C533	4030017490	S.CER C1608 JB 1A 105K-T	B	77.1/44.5
C534	4030016970	S.CER C1005 JB 1E 223K-T	B	77.5/42.5
C536	4610001850	S.TRI TZBX4R200AB10R00	B	81.0/39.7
C537	4030016930	S.CER C1005 JB 1A 104K-T	B	77.2/40.1
C538	4030016930	S.CER C1005 JB 1A 104K-T	B	77.2/37.6
C539	4030018910	S.CER C1608 JB 0J 475K-T	B	77.7/34.9
C540	4030018910	S.CER C1608 JB 0J 475K-T	B	58.5/37.0
C541	4030018970	S.CER C3225 JB 1C 226MT-N	B	59.2/28.9
C542	4030018910	S.CER C1608 JB 0J 475K-T	B	77.7/33.6
C543	4030018960	S.CER C3216 JB 1C 106MT-N	B	80.0/46.6
C544	4030018910	S.CER C1608 JB 0J 475K-T	B	77.7/32.3
C545	4030011600	S.CER C1608 JB 1E 104K-T	B	77.0/46.4
C549	4030018960	S.CER C3216 JB 1C 106MT-N	B	71.7/28.8
C550	4030018960	S.CER C3216 JB 1C 106MT-N	B	77.1/28.8
C551	4030018960	S.CER C3216 JB 1C 106MT-N	B	73.8/28.8
C559	4030017460	S.CER C1005 JB 1H 102K-T	B	29.4/43.9
C560	4030018960	S.CER C3216 JB 1C 106MT-N	B	17.0/33.2

Eqv.= This component is equivalent to the REF No. component listed above, and may be substituted on parts orders and repairs.

[DISPLAY UNIT]

REF NO.	PARTS NO.	DESCRIPTION	M.	H/V LOCATION
C561	4030017330	S.CER C1005 JF 1C 104Z-T	B	7.3/30.8
C562	4030017780	S.CER C1005 JB 1H 472K-T	B	6.1/30.9
C601	4030016930	S.CER C1005 JB 1A 104K-T	B	73.6/24.9
C602	4030016930	S.CER C1005 JB 1A 104K-T	B	48.8/43.5
C603	4030016930	S.CER C1005 JB 1A 104K-T	B	55.0/39.4
C604	4030018960	S.CER C3216 JB 1C 106MT-N	B	55.8/36.3
C605	4030016930	S.CER C1005 JB 1A 104K-T	B	50.9/48.0
C606	4030018960	S.CER C3216 JB 1C 106MT-N	B	49.1/47.5
C607	4030011600	S.CER C1608 JB 1E 104K-T	B	55.5/40.6
C608	4030018960	S.CER C3216 JB 1C 106MT-N	B	55.8/43.7
C609	4030011600	S.CER C1608 JB 1E 104K-T	B	50.6/31.7
C610	4030018960	S.CER C3216 JB 1C 106MT-N	B	52.3/33.5
C611	4550007220	S.TAN F931A476MCMBMA	B	73.5/22.1
C651	4030018960	S.CER C3216 JB 1C 106MT-N	B	16.9/17.6
C652	4030018960	S.CER C3216 JB 1C 106MT-N	B	6.7/17.1
C653	4030011600	S.CER C1608 JB 1E 104K-T	B	15.8/19.3
C654	4030017490	S.CER C1608 JB 1A 105K-T	B	3.5/20.4
C655	4030016790	S.CER C1005 JB 1E 103K-T	B	0.8/30.3
C656	4030019090	S.CER C2012 JB 1C 225M-T	B	7.8/25.6
C657	4030018520	S.CER C1608 JB 0J 225M-T	B	7.0/20.6
C658	4030017650	S.CER C1005 CH 1H 270J-T	B	5.5/20.6
C659	4030017780	S.CER C1005 JB 1H 472K-T	B	15.3/20.4
C701	4030018960	S.CER C3216 JB 1C 106MT-N	B	4.7/32.5
C702	4030018960	S.CER C3216 JB 1C 106MT-N	B	49.0/19.1
C801	4030016930	S.CER C1005 JB 1A 104K-T	B	63.0/19.8
C802	4030011600	S.CER C1608 JB 1E 104K-T	B	21.6/48.6
C851	4030017780	S.CER C1005 JB 1H 472K-T	B	32.1/23.9
C852	4030018960	S.CER C3216 JB 1C 106MT-N	B	40.3/15.9
C853	4030016930	S.CER C1005 JB 1A 104K-T	B	43.2/27.6
C2001	4030018520	S.CER C1608 JB 0J 225M-T	B	78.5/16.7
C2002	4030017780	S.CER C1005 JB 1H 472K-T	T	114.8/34.7
C2003	4030017630	S.CER C1005 CH 1H 120J-T	B	103.3/28.7
C2004	4030017630	S.CER C1005 CH 1H 120J-T	B	103.3/25.1
C2005	4030016790	S.CER C1005 JB 1E 103K-T	B	103.3/34.9
C2006	4030016930	S.CER C1005 JB 1A 104K-T	B	98.0/37.9
C2007	4030018960	S.CER C3216 JB 1C 106MT-N	B	105.8/47.7
C2008	4030017030	S.CER C1005 JB 1A 273K-T	B	109.7/44.6
C2009	4030016930	S.CER C1005 JB 1A 104K-T	B	99.0/37.9
C2010	4030016930	S.CER C1005 JB 1A 104K-T	B	100.0/37.9
C2011	4030016930	S.CER C1005 JB 1A 104K-T	B	78.7/29.9
C2012	4030017780	S.CER C1005 JB 1H 472K-T	B	95.8/37.9
C2013	4030017780	S.CER C1005 JB 1H 472K-T	B	93.1/37.9
C2014	4030016930	S.CER C1005 JB 1A 104K-T	T	110.4/41.7
C2015	4030016930	S.CER C1005 JB 1A 104K-T	B	103.1/35.8
C2016	4030016930	S.CER C1005 JB 1A 104K-T	B	82.8/28.5
J202	6510023801	S.CON S4B-ZR-SM4A-TF(LF)(SN)	B	115.9/39.4
J251	6510025771	S.CON 03-935H1-72BKA	B	154.2/45.8
J303	6510021431	S.CON S8B-ZR-SM4A-TF(LF)(SN)	B	115.9/20.9
J401	6510024840	S.CON 52746-1070	B	21.3/26.3
J601	6510024780	S.CON 52437-2472	B	45.1/42.1
J2001	6510024790	S.CON 52559-1072	B	96.9/47.6
DS805	5040003610	S.LED NSSW008C-P1	T	29.5/39.5
DS806	5040003610	S.LED NSSW008C-P1	T	29.5/31.5
DS807	5040003610	S.LED NSSW008C-P1	T	29.5/24.2
DS808	5040003610	S.LED NSSW008C-P1	T	29.5/16.2
DS2001	5040002930	S.LED SML-512MW T86	T	110.3/25.8
DS2002	5040002020	S.LED CL-170UR-CD-T	T	110.3/36.8
DS2004	5040002930	S.LED SML-512MW T86	T	11.5/20.6
S201	2230001160	S.SWI SPVP110100	T	157.4/34.3
S251	2220000330	S.SWI HSW0880-01-210	B	139.7/46.6
S701	2230001150	S.SWI LS9J2M-1FG-T	T	22.2/48.3
S702	2230001150	S.SWI LS9J2M-1FG-T	T	21.7/36.5
S703	2230001150	S.SWI LS9J2M-1FG-T	T	20.9/17.0
S704	2230001150	S.SWI LS9J2M-1FG-T	T	21.6/2.7
S721	2230001150	S.SWI LS9J2M-1FG-T	T	40.2/2.4
S722	2230001150	S.SWI LS9J2M-1FG-T	T	54.3/2.4
S723	2230001150	S.SWI LS9J2M-1FG-T	T	68.5/2.4
S724	2230001150	S.SWI LS9J2M-1FG-T	T	82.6/2.4
S741	2230001150	S.SWI LS9J2M-1FG-T	T	98.1/47.9
S742	2230001150	S.SWI LS9J2M-1FG-T	T	99.1/32.1
S743	2230001150	S.SWI LS9J2M-1FG-T	T	99.1/20.5
S744	2230001150	S.SWI LS9J2M-1FG-T	T	98.1/5.8
S761	2230001150	S.SWI LS9J2M-1FG-T	T	109.5/49.1
S762	2230001150	S.SWI LS9J2M-1FG-T	T	109.5/3.5
S763	2230001150	S.SWI LS9J2M-1FG-T	T	154.9/47.5
S764	2230001150	S.SWI LS9J2M-1FG-T	T	154.9/5.2
S781	2230001150	S.SWI LS9J2M-1FG-T	T	4.6/29.

[VR UNIT]

REF NO.	PARTS NO.	DESCRIPTION	M.	H/V LOCATION
R1	7210003230	VAR TP96D00A-17F-10KBX2-2427	T	1.3/32.6
R2	7030003860	S.RES ERJ3GE JPW V	T	2.3/30.0
R3	7030003860	S.RES ERJ3GE JPW V	T	
J1	6510024850	S.CON 54550-1094	T	3.4/22.3
S1	2250000170	ENC TP90D96AE20-17F (1352)		
EP4	6910012350	S.BEA MMZ1608Y 102BT	T	2.7/32.6
EP5	6910012350	S.BEA MMZ1608Y 102BT	T	3.7/30.0
EP6	6910012350	S.BEA MMZ1608Y 102BT	T	0.9/30.0
EP7	6910012350	S.BEA MMZ1608Y 102BT	T	0.9/14.5
EP8	6910012350	S.BEA MMZ1608Y 102BT	T	3.7/14.5
EP9	6910012350	S.BEA MMZ1608Y 102BT	T	2.7/11.8
EP10	6910012350	S.BEA MMZ1608Y 102BT	T	2.3/14.5
EP11	6910012350	S.BEA MMZ1608Y 102BT	T	1.3/11.8

[LOGIC UNIT]

REF NO.	PARTS NO.	DESCRIPTION	M.	H/V LOCATION
IC1	1130013281	S.IC TC58FVM6T5BTG65GCT (2427D-6) 1	T	28.0/30.2
IC2	1130011151	S.IC SN74AHC2G08HDCT3	B	40.3/38.3
IC3	1130011151	S.IC SN74AHC2G08HDCT3	B	40.7/32.5
IC4	1130012600	S.IC SN74AHC1G04DCKR	B	43.6/33.8
IC51	1130012842	S.IC CY7C1021DV33-10BVXIT <FE>	B	24.5/28.6
IC301	1140012541	S.IC ADSP-BF532SBBCZ400 <FE>	B	28.6/39.2
IC401	1110004770	S.IC BU9480F-E2	T	77.5/27.9
IC451	1110006570	S.IC TS462CPT	T	34.1/50.2
IC502	1110006570	S.IC TS462CPT	T	30.7/5.4
IC551	1190001611	S.IC AK4528VFP-E2/P	T	17.9/8.1
IC601	1110006570	S.IC TS462CPT	B	12.7/10.8
IC701	1130012600	S.IC SN74AHC1G04DCKR	B	2.7/15.9
IC1201	1130012792	S.IC CY22150KFZXCX <FE>	B	44.6/4.6
IC1212	1140012170	S.IC BH7236AF-E2	T	57.7/7.3
IC1217	1130007181	S.IC TC7WU04FU(TE12LF)	B	63.5/9.9
IC1218	1130012761	S.IC SN74AHC2G86HDCT3	B	52.7/6.6
IC1226	1130010871	S.IC S1D13706F00A200	B	53.8/19.9
IC1251	1180002020	S.REG BA033FP-E2	T	79.5/5.2
IC1301	1130016310	S.IC BR24T256FJ-WE2	T	81.4/36.2
IC1302	1140013137	S.IC HD6432375A23FQV(SX-2427B-7)	T	54.9/25.2
IC1303	1110005771	S.IC S-80942CNMC-G9CT2G	T	81.2/10.4
IC1304	1130011551	S.IC RX-4581NB-F	B	71.9/7.3
IC1402	1130012781	S.IC SN74AHC2G04HDCT3	T	79.1/18.9
IC2002	1130012842	S.IC CY7C1021DV33-10BVXIT <FE>	B	32.7/28.4
IC2101	1130012850	S.IC SN74LVC3G34DCUR	T	44.5/44.8
IC2102	1130012850	S.IC SN74LVC3G34DCUR	T	44.5/41.3
IC2201	1140012541	S.IC ADSP-BF532SBBCZ400 <FE>	B	28.6/17.7
Q201	1550000110	S.FET RTQ035P02TR	B	18.9/42.7
Q1101	1530004140	S.TRA L2SC4081RT1G <SLVJ>	T	82.2/20.4
Q1102	1590003940	S.TRA RN1105(TE85LF)	T	81.9/22.8
Q1103	1510000510	S.TRA 2SA1576A T106R	T	81.9/16.4
Q1201	1590003940	S.TRA RN1105(TE85LF)	T	44.8/13.3
D201	1750001280	S.DIO CUS02(TE85LQ)	B	19.2/45.3
D1001	1750000370	S.DIO DA221 TL	B	64.6/36.9
D1002	1750000370	S.DIO DA221 TL	B	65.0/34.6
D1101	1790001251	S.DIO MA2S1110GL	T	82.0/18.4
D1106	1750000951	S.DIO MA2J7320GL	T	80.1/29.7
D1107	1790001670	S.DIO RB706F-40T106	T	82.4/31.4
D1110	1790001670	S.DIO RB706F-40T106	T	75.8/32.4
D1111	1790001670	S.DIO RB706F-40T106	T	75.3/29.4
D1112	1790001670	S.DIO RB706F-40T106	B	79.2/29.2
D1113	1790001670	S.DIO RB706F-40T106	B	82.4/30.7
D1201	1790001251	S.DIO MA2S1110GL	B	83.0/40.5
D1301	1790000661	S.DIO MA2J7280GL	B	77.6/2.9
D1304	1750000370	S.DIO DA221 TL	T	76.1/19.9
D1305	1750000370	S.DIO DA221 TL	T	75.9/16.8
D1306	1750000370	S.DIO DA221 TL	B	49.3/32.9
D1307	1750000370	S.DIO DA221 TL	B	51.4/33.3
D1311	1790001251	S.DIO MA2S1110GL	B	81.0/19.7
D1312	1790001251	S.DIO MA2S1110GL	B	83.1/18.6
D1313	1790001251	S.DIO MA2S1110GL	B	80.1/22.7
D1314	1790001241	S.DIO MA2S7280GL	B	81.7/22.5
D1331	1790001251	S.DIO MA2S1110GL	B	65.6/17.5
X1201	6050012150	S.XTA CR-806 SMD-49TA 4.433619 MHz<KDS> [EUR]	B	61.4/3.1
	6050012150	S.XTA CR-806 SMD-49TA 4.433619 MHz<KDS> [FRA]		
	6050012150	S.XTA CR-806 SMD-49TA 4.433619 MHz<KDS> [ESP]		
	6050012140	S.XTA CR-805 SMD-49TA 3.579545 MHz<KDS> [USA]		
	6050012150	S.XTA CR-806 SMD-49TA 4.433619 MHz<KDS> [ITR]		
	6050012150	S.XTA CR-806 SMD-49TA 4.433619 MHz<KDS> [UK]		
	6050012140	S.XTA CR-805 SMD-49TA 3.579545 MHz<KDS> [KOR]		
	6050012150	S.XTA CR-806 SMD-49TA 4.433619 MHz<KDS> [AUS]		
	6050012150	S.XTA CR-806 SMD-49TA 4.433619 MHz<KDS> [CHN]		
X1301	6050012190	S.XTA CR-809 SMD-49TA 1539744 MHz <KDS>	B	60.5/30.8
L201	6200011900	S.COI LQH43CN100K03L	T	16.0/42.0
L202	6200009491	S.COI CDRH6D28NP-100NCI	B	13.3/42.3
L551	6200005011	S.COI NLV25T-100J	T	11.2/10.5
L552	6200005011	S.COI NLV25T-100J	T	11.2/5.9
L1202	6200002041	S.COI NLV25T-101J	B	52.4/2.3
L1203	6200002041	S.COI NLV25T-101J	T	66.7/3.5
L1204	6200002041	S.COI NLV25T-101J	B	58.0/10.4
L2101	6200005011	S.COI NLV25T-100J	T	41.0/45.1
L2102	6200005011	S.COI NLV25T-100J	T	40.3/41.6
R2	7030005090	S.RES ERJ2GEJ 104 X (100K)	T	39.6/30.2
R3	7030005090	S.RES ERJ2GEJ 104 X (100K)	T	39.6/32.3
R4	7030005090	S.RES ERJ2GEJ 104 X (100K)	T	31.8/45.9
R5	7030005090	S.RES ERJ2GEJ 104 X (100K)	T	30.9/45.9
R6	7030005090	S.RES ERJ2GEJ 104 X (100K)	T	30.0/45.9
R203	7030000010	S.RES MCR10EZJH JPW (000)	T	20.8/45.7
R301	7030004980	S.RES ERJ2GEJ 101 X (100)	T	25.4/45.9
R302	7030005050	S.RES ERJ2GEJ 103 X (10K)	T	26.9/45.9
R303	7030005050	S.RES ERJ2GEJ 103 X (10K)	T	27.8/45.9
R306	7030005050	S.RES ERJ2GEJ 103 X (10K)	B	38.2/31.2
R307	7030005050	S.RES ERJ2GEJ 103 X (10K)	T	22.1/41.4
R308	7030005050	S.RES ERJ2GEJ 103 X (10K)	T	22.1/40.5

Eqv.= This component is equivalent to the REF No. component listed above, and may be substituted on parts orders and repairs.

M.=Mounted side (T: Mounted on the Top side, B: Mounted on the Bottom side) S.=Surface mount

[LOGIC UNIT]

REF NO.	PARTS NO.	DESCRIPTION	M.	H/V LOCATION
R310	7030005050	S.RES ERJ2GEJ 103 X (10K)	B	35.4/38.0
R312	7030010040	S.RES ERJ2GEJ-JPW	B	33.7/46.0
R313	7030010040	S.RES ERJ2GEJ-JPW	B	35.6/43.3
R314	7030010040	S.RES ERJ2GEJ-JPW	B	35.6/40.6
R413	7030004980	S.RES ERJ2GEJ 101 X (100)	B	18.2/16.8
R414	7030004980	S.RES ERJ2GEJ 101 X (100)	T	16.3/19.9
R415	7030004980	S.RES ERJ2GEJ 101 X (100)	B	19.1/16.8
R416	7030004980	S.RES ERJ2GEJ 101 X (100)	B	17.3/16.8
R462	7030004980	S.RES ERJ2GEJ 101 X (100)	B	33.8/7.4
R463	7030004980	S.RES ERJ2GEJ 101 X (100)	T	43.6/8.8
R464	7030004980	S.RES ERJ2GEJ 101 X (100)	B	26.2/5.7
R465	7030009270	S.RES ERJ2GEJ 821 X (820)	B	28.7/5.2
R467	7030004980	S.RES ERJ2GEJ 101 X (100)	B	31.4/4.3
R469	7030009270	S.RES ERJ2GEJ 821 X (820)	B	30.5/4.3
R470	7030009140	S.RES ERJ2GEJ 272 X (2.7K)	T	29.4/3.1
R471	7030009140	S.RES ERJ2GEJ 272 X (2.7K)	T	34.0/3.3
R472	7030005040	S.RES ERJ2GEJ 472 X (4.7K)	T	38.7/4.2
R473	7030005040	S.RES ERJ2GEJ 472 X (4.7K)	T	38.7/3.2
R474	7030009140	S.RES ERJ2GEJ 272 X (2.7K)	B	24.8/7.2
R475	7030009140	S.RES ERJ2GEJ 272 X (2.7K)	B	33.8/9.2
R476	7030005040	S.RES ERJ2GEJ 472 X (4.7K)	T	40.3/3.3
R507	7030004980	S.RES ERJ2GEJ 101 X (100)	T	26.1/3.6
R508	7030004980	S.RES ERJ2GEJ 101 X (100)	T	31.7/9.0
R510	7030005040	S.RES ERJ2GEJ 472 X (4.7K)	T	32.6/9.0
R511	7030005040	S.RES ERJ2GEJ 472 X (4.7K)	T	29.0/9.0
R512	7030004980	S.RES ERJ2GEJ 101 X (100)	T	29.9/9.0
R514	7030005050	S.RES ERJ2GEJ 103 X (10K)	T	34.9/8.8
R515	7030005050	S.RES ERJ2GEJ 103 X (10K)	T	34.9/7.9
R516	7030005040	S.RES ERJ2GEJ 472 X (4.7K)	T	39.1/12.8
R517	7030005040	S.RES ERJ2GEJ 472 X (4.7K)	T	36.5/11.1
R518	7030009140	S.RES ERJ2GEJ 272 X (2.7K)	T	36.5/5.7
R519	7030009140	S.RES ERJ2GEJ 272 X (2.7K)	T	26.5/5.7
R520	7030005040	S.RES ERJ2GEJ 472 X (4.7K)	T	41.4/12.8
R551	7030004980	S.RES ERJ2GEJ 101 X (100)	T	16.6/13.5
R553	7030004980	S.RES ERJ2GEJ 101 X (100)	T	14.8/13.5
R554	7030005090	S.RES ERJ2GEJ 104 X (100K)	T	15.5/3.3
R568	7030004980	S.RES ERJ2GEJ 101 X (100)	T	13.0/13.5
R569	7030004980	S.RES ERJ2GEJ 101 X (100)	T	15.7/13.5
R570	7030004980	S.RES ERJ2GEJ 101 X (100)	T	13.9/13.5
R571	7030009320	S.RES ERJ2GEJ 4R7 X (4.7)	B	20.7/8.4
R601	7030004980	S.RES ERJ2GEJ 101 X (100)	T	3.1/12.4
R602	7030007300	S.RES ERJ2GEJ 332 X (3.3K)	T	11.9/8.5
R603	7030005040	S.RES ERJ2GEJ 472 X (4.7K)	B	12.4/4.9
R604	7030005040	S.RES ERJ2GEJ 472 X (4.7K)	B	13.3/4.9
R605	7030007300	S.RES ERJ2GEJ 332 X (3.3K)	B	14.5/5.2
R606	7030007300	S.RES ERJ2GEJ 332 X (3.3K)	B	12.9/7.3
R607	7030005290	S.RES ERJ2GEJ 682 X (6.8K)	B	13.9/7.3
R608	7030005290	S.RES ERJ2GEJ 682 X (6.8K)	B	14.9/6.5
R609	7030005040	S.RES ERJ2GEJ 472 X (4.7K)	T	11.0/8.5
R610	7030005040	S.RES ERJ2GEJ 472 X (4.7K)	B	9.0/4.3
R611	7030005040	S.RES ERJ2GEJ 472 X (4.7K)	B	9.9/4.3
R612	7030007300	S.RES ERJ2GEJ 332 X (3.3K)	B	11.5/5.7
R613	7030007300	S.RES ERJ2GEJ 332 X (3.3K)	B	8.9/7.0
R614	7030005290	S.RES ERJ2GEJ 682 X (6.8K)	B	9.8/7.0
R615	7030005290	S.RES ERJ2GEJ 682 X (6.8K)	B	10.7/7.0
R618	7030005120	S.RES ERJ2GEJ 102 X (1K)	B	14.5/4.3
R619	7030005120	S.RES ERJ2GEJ 102 X (1K)	B	10.8/4.3
R701	7030005050	S.RES ERJ2GEJ 103 X (10K)	B	4.6/22.8
R702	7030005050	S.RES ERJ2GEJ 103 X (10K)	B	4.6/23.7
R703	7030005050	S.RES ERJ2GEJ 103 X (10K)	B	4.5/25.9
R705	7030005120	S.RES ERJ2GEJ 102 X (1K)	B	5.0/21.0
R706	7030005050	S.RES ERJ2GEJ 103 X (10K)	B	4.5/17.2
R707	7030007250	S.RES ERJ2GEJ 220 X (22)	B	4.5/15.5
R1001	7030005120	S.RES ERJ2GEJ 102 X (1K)	B	70.9/37.0
R1002	7030005050	S.RES ERJ2GEJ 103 X (10K)	B	66.0/32.4
R1003	7030005160	S.RES ERJ2GEJ 105 X (1M)	B	70.4/35.8
R1004	7030005240	S.RES ERJ2GEJ 473 X (47K)	B	66.2/18.6
R1006	7030005120	S.RES ERJ2GEJ 102 X (1K)	B	52.0/34.9
R1007	7030005120	S.RES ERJ2GEJ 102 X (1K)	B	53.2/32.0
R1008	7030005120	S.RES ERJ2GEJ 102 X (1K)	B	75.1/20.5
R1010	7030005240	S.RES ERJ2GEJ 473 X (47K)	B	76.8/19.9
R1012	7030005000	S.RES ERJ2GEJ 471 X (470)	B	66.5/34.1
R1013	7030005000	S.RES ERJ2GEJ 471 X (470)	B	66.5/36.5
R1015	7030005240	S.RES ERJ2GEJ 473 X (47K)	B	50.4/34.9
R1016	7030005240	S.RES ERJ2GEJ 473 X (47K)	B	51.1/31.8
R1018	7030007340	S.RES ERJ2GEJ 153 X (15K)	B	63.4/34.5
R1019	7030007340	S.RES ERJ2GEJ 153 X (15K)	B	63.0/36.1
R1101	7030008290	S.RES ERJ2GEJ 183 X (18K)	T	80.1/15.5
R1102	7030008010	S.RES ERJ2GEJ 123 X (12K)	T	80.0/22.0
R1103	7030005120	S.RES ERJ2GEJ 102 X (1K)	T	80.0/22.9
R1104	7030005120	S.RES ERJ2GEJ 102 X (1K)	T	74.6/20.2
R1105	7030005050	S.RES ERJ2GEJ 103 X (10K)	T	79.7/14.3
R1106	7030005240	S.RES ERJ2GEJ 473 X (47K)	T	83.4/14.4
R1107	7030005090	S.RES ERJ2GEJ 104 X (100K)	T	79.2/15.5
R1108	7030005090	S.RES ERJ2GEJ 104 X (100K)	T	78.3/14.9
R1109	7030005160	S.RES ERJ2GEJ 105 X (1M)	T	78.4/22.0
R1110	7030005240	S.RES ERJ2GEJ 473 X (47K)	T	76.8/21.5
R1111	7030005090	S.RES ERJ2GEJ 104 X (100K)	T	77.4/14.9
R1113	7030007290	S.RES ERJ2GEJ 222 X (2.2K)	T	83.2/29.4
R1114	7030007300	S.RES ERJ2GEJ 332 X (3.3K)	T	82.3/29.4
R1115	7030005120	S.RES ERJ2GEJ 102 X (1K)	T	76.8/26.3
R1116	7030005120	S.RES ERJ2GEJ 102 X (1K)	T	77.0/28.2
R1117	7030005120	S.RES ERJ2GEJ 102 X (1K)	T	82.8/22.3
R1118	7030007300	S.RES ERJ2GEJ 332 X (3.3K)	B	83.1/23.9
R1119	7030007300	S.RES ERJ2GEJ 332 X (3.3K)	B	83.9/22.3
R1120	7030005120	S.RES ERJ2GEJ 102 X (1K)	B	84.2/23.9
R1123	7030005160	S.RES ERJ2GEJ 105 X (1M)	B	66.9/24.5
R1124	7030005120	S.RES ERJ2GEJ 102 X (1K)	B	82.0/20.0
R1126	7030005160	S.RES ERJ2GEJ 105 X (1M)	B	66.9/23.6
R1127	7030010040	S.RES ERJ2GEJ-JPW	T	73.7/18.5
R1128	7030005120	S.RES ERJ2GEJ 102 X (1K)	B	83.3/20.2
R1129	7030007300	S.RES ERJ2GEJ 332 X (3.3K)	B	82.0/28.4
R1131	7030005090	S.RES ERJ2GEJ 104 X (100K)	B	78.6/26.2
R1132	7030005040	S.RES ERJ2GEJ 472 X (4.7K)	B	81.4/24.5
R1201	7030005160	S.RES ERJ2GEJ 105 X (1M)	B	62.8/7.7

Eqv.= This component is equivalent to the REF No. component listed above, and may be substituted on parts orders and repairs.

[LOGIC UNIT]

REF NO.	PARTS NO.	DESCRIPTION	M.	H/V LOCATION
R1202	7030005050	S.RES ERJ2GEJ 103 X (10K)	B	49.2/7.5
R1203	7030005050	S.RES ERJ2GEJ 103 X (10K)	B	49.2/8.4
R1204	7030005050	S.RES ERJ2GEJ 103 X (10K)	B	49.7/9.6
R1205	7030010040	S.RES ERJ2GEJ-JPW	B	49.2/3.2
R1206	7030007570	S.RES ERJ2GEJ 122 X (1.2K)	B	46.1/9.6
R1207	7030007570	S.RES ERJ2GEJ 122 X (1.2K)	B	44.0/9.6
R1208	7030007570	S.RES ERJ2GEJ 122 X (1.2K)	B	43.5/11.4
R1209	7030009710	S.RES ERJ2GEJ 203 X (20K)	B	48.8/9.6
R1210	7030007570	S.RES ERJ2GEJ 122 X (1.2K)	B	47.9/9.6
R1211	7030005050	S.RES ERJ2GEJ 103 X (10K)	B	48.9/11.4
R1212	7030005050	S.RES ERJ2GEJ 103 X (10K)	B	48.0/11.4
R1213	7030005050	S.RES ERJ2GEJ 103 X (10K)	B	47.1/11.4
R1214	7030009710	S.RES ERJ2GEJ 203 X (20K)	B	46.2/11.4
R1215	7030007350	S.RES ERJ2GEJ 393 X (39K)	B	45.3/11.4
R1216	7030005050	S.RES ERJ2GEJ 103 X (10K)	B	44.7/12.6
R1217	7030005050	S.RES ERJ2GEJ 103 X (10K)	B	44.7/13.5
R1218	7030005050	S.RES ERJ2GEJ 103 X (10K)	B	44.7/14.4
R1219	7030005040	S.RES ERJ2GEJ 472 X (4.7K)	B	74.4/41.2
R1220	7030009710	S.RES ERJ2GEJ 203 X (20K)	B	44.7/15.3
R1221	7030005040	S.RES ERJ2GEJ 472 X (4.7K)	B	83.0/41.6
R1222	7030005040	S.RES ERJ2GEJ 472 X (4.7K)	B	74.4/40.3
R1223	7030005040	S.RES ERJ2GEJ 472 X (4.7K)	B	74.4/39.4
R1224	7030005040	S.RES ERJ2GEJ 472 X (4.7K)	B	83.0/39.3
R1225	7030005240	S.RES ERJ2GEJ 473 X (47K)	B	83.1/35.7
R1226	7030005240	S.RES ERJ2GEJ 473 X (47K)	B	74.4/37.6
R1227	7030005240	S.RES ERJ2GEJ 473 X (47K)	B	73.8/38.5
R1228	7030005240	S.RES ERJ2GEJ 473 X (47K)	B	82.2/35.7
R1229	7030007350	S.RES ERJ2GEJ 393 X (39K)	B	43.5/15.4
R1230	7030004970	S.RES ERJ2GEJ 470 X (47)	B	49.2/2.3
R1231	7030005050	S.RES ERJ2GEJ 103 X (10K)	B	48.8/5.4
R1232	7030005220	S.RES ERJ2GEJ 223 X (22K)	B	40.3/3.3
R1235	7030007270	S.RES ERJ2GEJ 151 X (150)	T	66.2/5.9
R1236	7030007270	S.RES ERJ2GEJ 151 X (150)	T	66.2/7.0
R1237	7030007290	S.RES ERJ2GEJ 222 X (2.2K)	B	61.2/7.7
R1251	7030011250	S.RES ERJ1TY 390U (39)	T	70.3/6.4
R1301	7030005220	S.RES ERJ2GEJ 223 X (22K)	T	78.2/37.9
R1302	7030005050	S.RES ERJ2GEJ 103 X (10K)	T	78.2/36.1
R1303	7030005240	S.RES ERJ2GEJ 473 X (47K)	B	66.1/21.3
R1304	7030005240	S.RES ERJ2GEJ 473 X (47K)	B	66.1/20.4
R1305	7030009160	S.RES ERJ2GEJ 181 X (180)	T	68.6/26.0
R1306	7030005060	S.RES ERJ2GEJ 333 X (33K)	T	78.8/11.5
R1307	7030005040	S.RES ERJ2GEJ 472 X (4.7K)	T	68.0/22.0
R1308	7030005110	S.RES ERJ2GEJ 224 X (220K)	T	67.6/20.1
R1309	7030005110	S.RES ERJ2GEJ 224 X (220K)	T	69.1/19.5
R1310	7030005110	S.RES ERJ2GEJ 224 X (220K)	T	67.6/18.9
R1311	7030005110	S.RES ERJ2GEJ 224 X (220K)	T	69.1/18.3
R1312	7030005110	S.RES ERJ2GEJ 224 X (220K)	T	67.6/17.7
R1313	7030005110	S.RES ERJ2GEJ 224 X (220K)	T	69.1/17.1
R1314	7030005110	S.RES ERJ2GEJ 224 X (220K)	T	67.6/16.5
R1315	7030005110	S.RES ERJ2GEJ 224 X (220K)	T	69.1/15.9
R1316	7030005110	S.RES ERJ2GEJ 224 X (220K)	B	66.6/12.4
R1317	7030005110	S.RES ERJ2GEJ 224 X (220K)	B	65.7/12.4
R1318	7030005110	S.RES ERJ2GEJ 224 X (220K)	B	64.8/12.4
R1319	7030005110	S.RES ERJ2GEJ 224 X (220K)	B	63.9/12.4
R1320	7030005110	S.RES ERJ2GEJ 224 X (220K)	B	63.0/12.4
R1321	7030005110	S.RES ERJ2GEJ 224 X (220K)	B	62.1/12.4
R1322	7030005110	S.RES ERJ2GEJ 224 X (220K)	B	61.2/12.4
R1323	7030005110	S.RES ERJ2GEJ 224 X (220K)	B	60.3/12.2
R1324	7030005050	S.RES ERJ2GEJ 103 X (10K)	T	80.5/12.6
R1325	7030007350	S.RES ERJ2GEJ 393 X (39K)	T	78.2/9.9
R1326	7030005010	S.RES ERJ2GEJ 681 X (680)	B	79.0/2.1
R1327	7030005240	S.RES ERJ2GEJ 473 X (47K)	B	66.1/19.5
R1328	7030005050	S.RES ERJ2GEJ 103 X (10K)	B	75.9/6.4
R1329	7030005240	S.RES ERJ2GEJ 473 X (47K)	B	75.9/5.0
R1331	7030010040	S.RES ERJ2GEJ-JPW	B	75.9/3.2
R1332	7030005040	S.RES ERJ2GEJ 472 X (4.7K)	B	75.9/4.1
R1333	7030005110	S.RES ERJ2GEJ 224 X (220K)	T	67.5/27.0
R1334	7030005050	S.RES ERJ2GEJ 103 X (10K)	T	78.4/12.7
R1335	7030010040	S.RES ERJ2GEJ-JPW	B	78.5/5.2
R1337	7030005240	S.RES ERJ2GEJ 473 X (47K)	T	41.0/15.6
R1338	7030005240	S.RES ERJ2GEJ 473 X (47K)	T	41.0/16.5
R1339	7030007290	S.RES ERJ2GEJ 222 X (2.2K)	B	65.6/22.5
R1401	7030005240	S.RES ERJ2GEJ 473 X (47K)	B	62.8/24.2
R1402	7030005240	S.RES ERJ2GEJ 473 X (47K)	B</	

[LOGIC UNIT]

REF NO.	PARTS NO.	DESCRIPTION	M.	H/V LOCATION
C1	4030016930	S.CER C1005 JB 1A 104K-T	T	16.9/25.2
C2	4030016930	S.CER C1005 JB 1A 104K-T	B	38.2/36.1
C3	4030016930	S.CER C1005 JB 1A 104K-T	B	39.6/29.0
C4	4030016930	S.CER C1005 JB 1A 104K-T	B	42.4/35.9
C5	4550007310	S.TAN F930J227MNMBA	T	40.8/23.5
C51	4030016930	S.CER C1005 JB 1A 104K-T	B	19.3/27.5
C52	4030016930	S.CER C1005 JB 1A 104K-T	B	19.3/28.4
C53	4550007310	S.TAN F930J227MNMBA	B	11.4/30.3
C54	4550007310	S.TAN F930J227MNMBA	T	7.2/8.1
C201	4030016930	S.CER C1005 JB 1A 104K-T	B	19.1/40.3
C203	4030018960	S.CER C3216 JB 1C 106MT-N	T	18.8/45.5
C204	4030016930	S.CER C1005 JB 1A 104K-T	T	12.0/40.2
C205	4030016930	S.CER C1005 JB 1A 104K-T	T	12.0/41.8
C206	4030016930	S.CER C1005 JB 1A 104K-T	B	8.9/43.5
C207	4030019460	S.CER C1608 JB 0J 106M-T	T	9.9/45.0
C302	4030016930	S.CER C1005 JB 1A 104K-T	T	30.3/40.5
C303	4030016930	S.CER C1005 JB 1A 104K-T	T	30.5/37.9
C304	4030016930	S.CER C1005 JB 1A 104K-T	T	27.0/37.3
C305	4030016930	S.CER C1005 JB 1A 104K-T	T	34.1/45.9
C306	4030016930	S.CER C1005 JB 1A 104K-T	T	29.3/37.3
C307	4030016930	S.CER C1005 JB 1A 104K-T	B	38.3/35.1
C308	4030016930	S.CER C1005 JB 1A 104K-T	T	27.4/39.4
C309	4030016930	S.CER C1005 JB 1A 104K-T	T	30.7/39.2
C310	4030016930	S.CER C1005 JB 1A 104K-T	T	24.5/45.9
C311	4030016930	S.CER C1005 JB 1A 104K-T	T	22.0/42.3
C312	4030016930	S.CER C1005 JB 1A 104K-T	T	27.9/40.6
C313	4030016930	S.CER C1005 JB 1A 104K-T	T	22.0/39.6
C314	4030016930	S.CER C1005 JB 1A 104K-T	T	29.1/45.9
C315	4030016930	S.CER C1005 JB 1A 104K-T	T	27.4/38.5
C316	4030016930	S.CER C1005 JB 1A 104K-T	T	30.5/37.0
C317	4030016930	S.CER C1005 JB 1A 104K-T	T	27.0/40.6
C318	4030016930	S.CER C1005 JB 1A 104K-T	T	31.2/40.5
C319	4030016930	S.CER C1005 JB 1A 104K-T	T	29.4/40.5
C320	4030016930	S.CER C1005 JB 1A 104K-T	T	27.9/37.3
C413	4030018960	S.CER C3216 JB 1C 106MT-N	B	21.3/19.7
C414	4030016930	S.CER C1005 JB 1A 104K-T	B	16.4/16.8
C415	4030018960	S.CER C3216 JB 1C 106MT-N	B	15.6/26.4
C461	4030016930	S.CER C1005 JB 1A 104K-T	B	34.2/4.3
C462	4030018960	S.CER C3216 JB 1C 106MT-N	B	35.3/5.9
C463	4030018960	S.CER C3216 JB 1C 106MT-N	T	42.1/8.8
C464	4030016930	S.CER C1005 JB 1A 104K-T	T	43.6/10.4
C465	4030017740	S.CER C1005 JB 1H 821K-T	B	27.5/5.5
C466	4030017760	S.CER C1005 JB 1H 222K-T	B	29.6/4.3
C467	4030017740	S.CER C1005 JB 1H 821K-T	B	30.8/5.5
C468	4030018560	S.CER C2012 JB 1A 475K-T	T	31.9/2.7
C469	4030016930	S.CER C1005 JB 1A 104K-T	B	24.8/8.8
C470	4030016930	S.CER C1005 JB 1A 104K-T	B	33.8/8.3
C471	4030018560	S.CER C2012 JB 1A 475K-T	T	36.2/4.3
C472	4030018560	S.CER C2012 JB 1A 475K-T	T	36.2/2.5
C473	4030016930	S.CER C1005 JB 1A 104K-T	T	40.3/4.2
C509	4030018960	S.CER C3216 JB 1C 106MT-N	T	24.3/5.6
C510	4030016930	S.CER C1005 JB 1A 104K-T	T	26.1/4.5
C511	4030017760	S.CER C1005 JB 1H 222K-T	T	30.8/9.0
C512	4030017690	S.CER C1005 CH 1H 121J-T	T	32.1/7.8
C513	4030017690	S.CER C1005 CH 1H 121J-T	T	29.4/7.8
C514	4030016930	S.CER C1005 JB 1A 104K-T	T	36.5/6.6
C515	4030018860	S.CER C1005 JB 0J 105K-T	T	36.5/9.3
C516	4030018860	S.CER C1005 JB 0J 105K-T	T	36.5/8.4
C517	4030018860	S.CER C1005 JB 0J 105K-T	T	36.5/10.2
C518	4030016930	S.CER C1005 JB 1A 104K-T	T	26.2/6.9
C519	4030016930	S.CER C1005 JB 1A 104K-T	T	41.4/11.9
C522	4030017780	S.CER C1005 JB 1H 472K-T	B	39.0/9.9
C523	4030017780	S.CER C1005 JB 1H 472K-T	B	38.1/2.9
C524	4030017780	S.CER C1005 JB 1H 472K-T	T	3.9/2.7
C525	4030017780	S.CER C1005 JB 1H 472K-T	T	22.5/2.8
C526	4030017780	S.CER C1005 JB 1H 472K-T	T	43.0/3.9
C527	4030017780	S.CER C1005 JB 1H 472K-T	B	24.1/2.9
C551	4030018520	S.CER C1608 JB 0J 225M-T	T	20.1/13.9
C553	4030016930	S.CER C1005 JB 1A 104K-T	T	19.0/13.9
C563	4030018960	S.CER C3216 JB 1C 106MT-N	B	18.9/6.7
C564	4030016930	S.CER C1005 JB 1A 104K-T	T	18.1/13.9
C565	4030016930	S.CER C1005 JB 1A 104K-T	T	17.8/3.3
C566	4030016930	S.CER C1005 JB 1A 104K-T	T	19.4/3.3
C567	4030018960	S.CER C3216 JB 1C 106MT-N	B	21.3/12.3
C569	4030018960	S.CER C3216 JB 1C 106MT-N	B	19.2/12.3
C601	4030018960	S.CER C3216 JB 1C 106MT-N	B	3.7/12.0
C602	4030016930	S.CER C1005 JB 1A 104K-T	T	4.0/11.0
C603	4030018820	S.CER C1005 JB 1H 561K-T	B	13.5/6.1
C604	4510008640	S.ELE 6 CE 100 FE	B	4.8/6.7
C605	4030016930	S.CER C1005 JB 1A 104K-T	T	10.1/8.5
C606	4030018580	S.CER C1608 CH 1H 821J-T	B	9.7/5.6
C607	4030017440	S.CER C1005 CH 1H 221J-T	B	13.4/8.5
C608	4030017440	S.CER C1005 CH 1H 221J-T	B	14.9/8.1
C609	4030018860	S.CER C1005 JB 0J 105K-T	B	15.8/14.6
C610	4030010760	S.CER C1608 CH 1H 331J-T	B	9.7/8.3
C611	4030010760	S.CER C1608 CH 1H 331J-T	B	11.8/7.8
C612	4030018960	S.CER C3216 JB 1C 106MT-N	B	7.5/13.2
C613	4550006780	S.TAN TEESVB2 0J 476M8R	B	20.6/2.8
Eqv.	4550007200	S.TAN F930J476MBA	T	3.1/6.6
C614	4550006780	S.TAN TEESVB2 0J 476M8R	T	3.1/6.6
Eqv.	4550007200	S.TAN F930J476MBA	T	3.1/6.6
C651	4030017460	S.CER C1005 JB 1H 102K-T	B	65.5/31.5
C652	4030017460	S.CER C1005 JB 1H 102K-T	B	66.0/16.5
C653	4030017460	S.CER C1005 JB 1H 102K-T	B	77.1/21.0
C654	4030017430	S.CER C1005 CH 1H 101J-T	B	77.2/28.2
C655	4030017430	S.CER C1005 CH 1H 101J-T	B	76.6/27.1
C656	4030017430	S.CER C1005 CH 1H 101J-T	B	76.2/26.2
C701	4030016930	S.CER C1005 JB 1A 104K-T	B	3.1/13.6
C702	4030017780	S.CER C1005 JB 1H 472K-T	B	4.5/18.8
C703	4030017780	S.CER C1005 JB 1H 472K-T	B	7.5/26.1
C704	4030017780	S.CER C1005 JB 1H 472K-T	B	19.8/26.2
C705	4030017430	S.CER C1005 CH 1H 101J-T	B	4.6/21.9
C706	4030017430	S.CER C1005 CH 1H 101J-T	B	4.6/24.6
C707	4030017430	S.CER C1005 CH 1H 101J-T	B	4.0/27.2
C708	4030017430	S.CER C1005 CH 1H 101J-T	B	6.6/26.1

Eqv.= This component is equivalent to the REF No. component listed above, and may be substituted on parts orders and repairs.

[LOGIC UNIT]

REF NO.	PARTS NO.	DESCRIPTION	M.	H/V LOCATION
C709	4030017430	S.CER C1005 CH 1H 101J-T	T	2.6/20.2
C711	4550007310	S.TAN F930J227MNMBA	T	5.6/19.0
C715	4030017460	S.CER C1005 JB 1H 102K-T	T	2.3/17.7
C716	4030017460	S.CER C1005 JB 1H 102K-T	T	2.3/16.7
C717	4030017460	S.CER C1005 JB 1H 102K-T	T	2.3/16.7
C1001	4030017780	S.CER C1005 JB 1H 472K-T	B	76.8/19.0
C1002	4030017780	S.CER C1005 JB 1H 472K-T	B	70.4/38.2
C1101	4030017780	S.CER C1005 JB 1H 472K-T	T	80.0/23.8
C1102	4030017780	S.CER C1005 JB 1H 472K-T	T	73.7/20.7
C1103	4030016930	S.CER C1005 JB 1A 104K-T	T	81.9/14.6
C1106	4030017780	S.CER C1005 JB 1H 472K-T	T	79.8/31.9
C1107	4030016930	S.CER C1005 JB 1A 473K-T	B	80.2/25.6
C1108	4030018900	S.CER C1005 JB 0J 474K-T	B	81.4/25.4
C1109	4030017780	S.CER C1005 JB 1H 472K-T	T	79.7/26.3
C1110	4030017780	S.CER C1005 JB 1H 472K-T	T	80.7/26.3
C1111	4030017780	S.CER C1005 JB 1H 472K-T	T	81.7/26.3
C1112	4030017780	S.CER C1005 JB 1H 472K-T	B	83.0/28.4
C1201	4030016930	S.CER C1005 JB 1A 104K-T	B	50.6/4.4
C1202	4030017780	S.CER C1005 JB 1H 472K-T	B	53.2/4.4
C1203	4030017650	S.CER C1005 CH 1H 270J-T	B	62.8/6.8
C1204	4030016930	S.CER C1005 JB 1A 104K-T	B	47.9/8.0
C1205	4030016930	S.CER C1005 JB 1A 104K-T	B	45.2/9.6
C1206	4030016930	S.CER C1005 JB 1A 104K-T	B	43.5/13.8
C1207	4030017430	S.CER C1005 CH 1H 101J-T	B	47.0/9.6
C1208	4030017430	S.CER C1005 CH 1H 101J-T	B	44.0/8.7
C1209	4030017430	S.CER C1005 CH 1H 101J-T	B	44.4/11.4
C1210	4030017650	S.CER C1005 CH 1H 270J-T	B	61.2/6.8
C1211	4030018860	S.CER C1005 JB 0J 105K-T	B	60.3/10.6
C1212	4030016930	S.CER C1005 JB 1A 104K-T	B	49.7/4.4
C1213	4030016930	S.CER C1005 JB 1A 104K-T	B	49.2/6.6
C1214	4030016930	S.CER C1005 JB 1A 104K-T	B	40.3/4.9
C1215	4030016930	S.CER C1005 JB 1A 104K-T	B	64.3/19.4
C1216	4030016930	S.CER C1005 JB 1A 104K-T	B	53.8/30.3
C1217	4030016930	S.CER C1005 JB 1A 104K-T	B	57.5/29.3
C1218	4030016930	S.CER C1005 JB 1A 104K-T	B	44.9/24.0
C1219	4030016930	S.CER C1005 JB 1A 104K-T	B	46.3/13.2
C1220	4030016930	S.CER C1005 JB 1A 104K-T	B	56.0/8.8
C1221	4030016930	S.CER C1005 JB 1A 104K-T	B	60.5/13.8
C1222	4030016930	S.CER C1005 JB 1A 104K-T	B	60.9/25.6
C1223	4030016930	S.CER C1005 JB 1A 104K-T	T	52.8/12.3
C1225	4030018960	S.CER C3216 JB 1C 106MT-N	T	66.8/10.2
C1251	4030012610	S.CER C2012 JB 1C 474K-T	T	73.5/9.4
C1252	4550007320	S.TAN F930J226MAABMA	T	73.5/4.5
C1301	4030016930	S.CER C1005 JB 1A 104K-T	T	80.2/40.3
C1302	4030018960	S.CER C3216 JB 1C 106MT-N	T	47.9/11.4
C1303	4030016790	S.CER C1005 JB 1E 103K-T	T	68.0/30.5
C1304	4030016930	S.CER C1005 JB 1A 104K-T	T	41.7/31.6
C1305	4030018960	S.CER C3216 JB 1C 106MT-N	T	44.3/37.3
C1306	4030016790	S.CER C1005 JB 1E 103K-T	T	64.1/37.6
C1307	4030016930	S.CER C1005 JB 1A 104K-T	T	48.5/13.0
C1308	4030016930	S.CER C1005 JB 1A 104K-T	T	63.2/13.2
C1309	4030016930	S.CER C1005 JB 1A 104K-T	T	46.2/37.3
C1310	4030016930	S.CER C1005 JB 1A 104K-T	T	67.1/31.0
C1311	4030016930	S.CER C1005 JB 1A 104K-T	T	67.1/25.8
C1312	4030017620	S.CER C1005 CH 1H 100C-T	T	67.5/29.2
C1313	4030017620	S.CER C1005 CH 1H 100C-T	T	67.5/28.3
C1314	4030016930	S.CER C1005 JB 1A 104K-T	T	79.1/9.9
C1315	4030017030	S.CER C1005 JB 1A 273K-T	T	83.4/10.9
C1316	4030016930	S.CER C1005 JB 1A 104K-T	B	75.9/2.3
C1317	4030018960	S.CER C3216 JB 1C 106MT-N	B	84.5/3.0
C1319	4030018960	S.CER C3216 JB 1C 106MT-N	B	16.8/6.7
C2016	4030016930	S.CER C1005 JB 1A 104K-T	B	37.7/29.4
C2017	4030016930	S.CER C1005 JB 1A 104K-T	B	37.7/30.3
C2101	4030016930	S.CER C1005 JB 1A 104K-T	T	44.1/43.0
C2102	4030016930	S.CER C1005 JB 1A 104K-T	T	45.8/43.0
C2202	4030016930	S.CER C1005 JB 1A 104K-T	T	27.1/16.6
C2204	4030016930	S.CER C1005 JB 1A 104K-T	T	26.6/19.3
C2205	4030016930	S.CER C1005 JB 1A 104K-T	T	30.2/19.8
C2206	4030016930	S.CER C1005 JB 1A 104K-T	T	26.6/11.1
C2207	4030016930	S.CER C1005 JB 1A 104K-T	T	27.8/19.8
C2208				

[CONNECT UNIT]

REF NO.	PARTS NO.	DESCRIPTION	M.	H/V LOCATION
J1	6510019971	S.CON 52808-1071	T	7.1/11.9
W1	8900016410	CAB OPC-1579A		

[DDS UNIT]

REF NO.	PARTS NO.	DESCRIPTION	M.	H/V LOCATION
IC51	1190001811	S.IC AD9833BRMZ-REEL7 <FE>	T	38.7/3.5
IC52	1130012781	S.IC SN74AHC2G04HDCT3	T	45.0/5.7
IC61	1130012610	S.IC SN74AHC1GU04DCKR	T	37.5/7.6
IC62	1130012850	S.IC SN74LVC3G34DCUR	T	51.4/24.7
IC251	1180002322	S.REG TK11218CMCL-GH	B	29.5/16.2
IC301	1190002101	S.IC AD9951YSVZ <FE>	T	37.5/28.2
IC401	1110004080	S.IC UPC2709T-E3	B	17.5/21.6
IC451	1110006430	S.IC UPC1678GV-E1-A	B	29.2/7.9
IC801	1110006430	S.IC UPC1678GV-E1-A	T	18.1/13.8
IC901	1130012720	S.IC CD74HC4094PWR	T	5.4/64.7
Q1	1530002381	S.TRA 2SC4215-Y(TE85LF)	T	20.5/3.2
Q101	1530002561	S.TRA 2SC4403-3-TL-E	T	26.6/6.4
Q151	1530003151	S.TRA 2SC4673D-TD-E	T	41.5/13.7
Q201	1530003432	S.TRA 2SC5226A-4-TL-E	T	43.5/19.5
Q211	1530003432	S.TRA 2SC5226A-4-TL-E	B	43.5/15.3
Q301	1590000680	S.TRA DTC114EUA T106	B	45.4/32.3
Q901	1590004030	S.TRA KRX204U-RTK/P	T	4.1/58.7
Q902	1590004030	S.TRA KRX204U-RTK/P	T	4.1/55.1
Q903	1590004030	S.TRA KRX204U-RTK/P	T	7.2/55.1
Q904	1590004030	S.TRA KRX204U-RTK/P	T	7.2/58.7
Q905	1590004030	S.TRA KRX204U-RTK/P	T	4.1/70.7
Q906	1590004030	S.TRA KRX204U-RTK/P	T	4.1/74.2
Q907	1590004030	S.TRA KRX204U-RTK/P	T	7.1/70.7
Q908	1590004030	S.TRA KRX204U-RTK/P	T	7.1/74.2
Q1101	1530004140	S.TRA L2SC4081RT1G <SLVJ>	T	40.9/53.9
Q1102	1540000451	S.TRA 2SD1623T-TD-E	T	45.5/54.3
D301	1750000620	S.DIO MA717WK(TX)	B	44.8/35.9
D341	1790001621	S.DIO 1SV308(TPL3F)	B	45.2/39.8
D451	1750000581	S.DIO 1SV307(TPH3F)	T	44.3/47.8
D452	1750000581	S.DIO 1SV307(TPH3F)	T	44.0/44.9
D453	1790001621	S.DIO 1SV308(TPL3F)	T	43.3/36.7
D454	1750000581	S.DIO 1SV307(TPH3F)	T	38.4/48.3
D456	1750000620	S.DIO MA717WK(TX)	B	35.2/42.9
D458	1750000581	S.DIO 1SV307(TPH3F)	T	33.8/45.6
D459	1750000581	S.DIO 1SV307(TPH3F)	T	31.4/38.9
D471	1750000620	S.DIO MA717WK(TX)	T	33.3/36.7
D501	1750000581	S.DIO 1SV307(TPH3F)	B	26.3/42.6
D502	1750000581	S.DIO 1SV307(TPH3F)	T	3.1/50.6
D551	1750000581	S.DIO 1SV307(TPH3F)	T	26.0/45.1
D552	1750000581	S.DIO 1SV307(TPH3F)	T	2.9/45.3
D601	1750000581	S.DIO 1SV307(TPH3F)	T	27.2/39.9
D602	1750000581	S.DIO 1SV307(TPH3F)	T	2.9/40.1
D651	1750000581	S.DIO 1SV307(TPH3F)	T	27.2/34.8
D652	1750000581	S.DIO 1SV307(TPH3F)	T	2.9/34.9
D701	1750000581	S.DIO 1SV307(TPH3F)	T	27.2/29.5
D702	1750000581	S.DIO 1SV307(TPH3F)	T	2.9/29.7
D751	1750000581	S.DIO 1SV307(TPH3F)	T	27.0/24.4
D752	1750000581	S.DIO 1SV307(TPH3F)	T	2.9/24.7
D801	1750000581	S.DIO 1SV307(TPH3F)	T	28.4/21.6
D802	1750000581	S.DIO 1SV307(TPH3F)	T	2.9/19.4
D1101	1750000301	S.DIO 1SS302(TE85RF)	T	40.9/57.7
D1102	1160000080	S.DIO DAP202K T146	B	28.0/63.1
FI101	2010002660	S.XTA DSF334SAF 124.032 MHz (FL-391)	T	29.4/10.7
FI201	2040001860	S.SAW NSVS776	T	34.5/16.6
X1	6050012800	S.XTA CR-788B VC-TCXO 24.8064 MHz	T	13.8/3.8
L51	6200005011	S.COI NLV25T-100J	B	35.6/4.2
L52	6200005011	S.COI NLV25T-100J	B	38.8/3.8
L53	6200003241	S.COI NLV32T-221J	B	43.5/8.7
L54	6200009351	S.COI ELJRE R22GFA	T	34.6/8.6
L101	6200003540	S.COI MLF1608D R22K-T	T	24.3/8.9
L105	6200012650	S.COI MLF1608A 1R5J-T	T	23.7/5.2
L151	6200004470	S.COI MLF1608D R12K-T	T	44.7/12.9
L153	6200004150	S.COI MLF1608D 47NM-T	T	46.9/15.7
L201	6200004150	S.COI MLF1608D 47NM-T	T	44.5/21.6
L202	6200005661	S.COI ELJRE 10NGFA	B	37.5/12.5
L204	6200003540	S.COI MLF1608D R22K-T	T	41.6/19.3
L205	6200005711	S.COI ELJRE 27NGFA	B	47.1/21.8
L206	6200005701	S.COI ELJRE 22NGFA	B	46.3/20.5
L210	6200005701	S.COI ELJRE 22NGFA	B	47.0/19.2
L212	6200002581	S.COI NLV25T-033J	B	41.9/12.8
L213	6200005681	S.COI ELJRE 15NGFA	B	40.1/17.9
L301	6140002810	S.COI LR-317	T	48.6/30.1
L302	6140002810	S.COI LR-317	T	48.8/38.9
L303	6200004150	S.COI MLF1608D 47NM-T	B	41.9/35.7
L304	6200003960	S.COI MLF1608A 1R0K-T	T	50.5/33.3
	6200003960	S.COI MLF1608A 1R0K-T	[EUR]	
	6200003960	S.COI MLF1608A 1R0K-T	[FRA]	
	6200003960	S.COI MLF1608A 1R0K-T	[ESP]	
	6200003960	S.COI MLF1608A 1R0K-T	[USA]	
	6200003960	S.COI MLF1608A 1R0K-T	[ITR]	
	6200003960	S.COI MLF1608A 1R0K-T	[UK]	
	6200003960	S.COI MLF1608A 1R0K-T	[KOR]	
	6200003960	S.COI MLF1608A 1R0K-T	[CHN]	
L321	6200009560	S.COI MLG1608B R10J-T	T	50.5/34.7
L322	6200011770	S.COI LQW18ANR10G00D	T	47.9/34.7
L323	6200005671	S.COI ELJRE 12NGFA	T	53.6/30.1
L331	6200009680	S.COI MLG1608B 47NJ-T	T	47.7/43.2
L332	6200009680	S.COI MLG1608B 47NJ-T	T	50.3/43.2
L341	6200004470	S.COI MLF1608D R12K-T	B	41.2/37.0
L401	6200001981	S.COI NLV25T-1R0J	T	50.3/50.0
L411	6200009610	S.COI MLG1608B 39NJ-T	T	47.3/48.4
L456	6140002810	S.COI LR-317	T	40.1/44.9
L458	6200009680	S.COI MLG1608B 47NJ-T	B	37.5/42.1
L461	6200009660	S.COI MLG1608B 10NJ-T	B	39.3/41.8
L464	6200002631	S.COI NLV25T-R10J	T	28.8/50.6

Eqv.= This component is equivalent to the REF No. component listed above, and may be substituted on parts orders and repairs.

M.=Mounted side (T: Mounted on the Top side, B: Mounted on the Bottom side) S.=Surface mount

[DDS UNIT]

REF NO.	PARTS NO.	DESCRIPTION	M.	H/V LOCATION
L465	6200004470	S.COI MLF1608D R12K-T	T	42.9/39.6
L466	6200011580	S.COI LQW18AN33NG00D	T	39.2/41.1
L467	6200009670	S.COI MLG1608B 12NJ-T	T	27.7/47.1
L468	6200009590	S.COI MLG1608B 18NJ-T	T	26.2/48.4
L469	6200009580	S.COI MLG1608B 15NJ-T	T	33.7/41.3
L471	6140002810	S.COI LR-317	T	38.7/37.3
L472	6200009680	S.COI MLG1608B 47NJ-T	T	33.4/39.4
L473	6200009540	S.COI MLG1608B 22NJ-T	T	35.5/40.5
L501	6200002611	S.COI NLV25T-R47J	B	21.8/43.7
L502	6200002631	S.COI NLV25T-R10J	B	18.2/46.8
L503	6200002431	S.COI NLV25T-082J	B	15.1/46.4
L504	6200002411	S.COI NLV25T-056J	T	14.4/49.4
L505	6200002421	S.COI NLV25T-068J	T	11.2/50.2
L506	6200002421	S.COI NLV25T-068J	T	8.3/49.7
L507	6200002611	S.COI NLV25T-R47J	T	3.9/48.2
L551	6200002611	S.COI NLV25T-R47J	T	24.9/42.6
L552	6200002421	S.COI NLV25T-068J	T	20.4/43.0
L553	6200002411	S.COI NLV25T-056J	T	17.6/42.9
L554	6200002601	S.COI NLV25T-047J	T	14.8/45.0
L555	6200002601	S.COI NLV25T-047J	T	12.0/44.3
L556	6200002581	S.COI NLV25T-033J	T	9.3/45.0
L557	6200002611	S.COI NLV25T-R47J	T	4.5/42.9
L601	6200002611	S.COI NLV25T-R47J	T	25.3/37.4
L602	6200002601	S.COI NLV25T-047J	T	22.6/39.6
L603	6200002591	S.COI NLV25T-039J	T	19.8/39.1
L604	6200003891	S.COI NLV25T-027J	T	16.9/39.9
L605	6200002601	S.COI NLV25T-047J	T	14.2/37.9
L606	6200002601	S.COI NLV25T-047J	T	11.4/37.7
L607	6200002421	S.COI NLV25T-068J	T	8.6/37.7
L608	6200002601	S.COI NLV25T-047J	T	5.1/37.7
L651	6200002611	S.COI NLV25T-R47J	T	26.0/32.2
L652	6200002591	S.COI NLV25T-039J	T	22.4/32.5
L653	6200002591	S.COI NLV25T-039J	T	19.6/32.8
L654	6200002591	S.COI NLV25T-039J	T	14.0/34.6
L655	6200002591	S.COI NLV25T-039J	T	11.2/33.9
L656	6200002601	S.COI NLV25T-047J	T	16.7/32.5
L657	6200002581	S.COI NLV25T-033J	T	7.9/34.6
L658	6200002611	S.COI NLV25T-R47J	T	5.2/32.6
L701	6200002611	S.COI NLV25T-R47J	T	26.0/26.9
L702	6200002581	S.COI NLV25T-033J	T	23.0/29.2
L703	6200002581	S.COI NLV25T-033J	T	20.2/28.8
L704	6200003891	S.COI NLV25T-027J	T	17.3/29.5
L705	6200002591	S.COI NLV25T-039J	T	14.6/27.3
L706	6200002581	S.COI NLV25T-033J	T	11.9/27.3
L707	6200002581	S.COI NLV25T-033J	T	9.1/27.3
L708	6200002611	S.COI NLV25T-R47J	T	4.6/27.3
L751	6200002611	S.COI NLV25T-R47J	T	26.0/22.0
L752	6200003881	S.COI NLV25T-022J	T	22.5/22.4
L753	6200003891	S.COI NLV25T-027J	T	19.7/22.2
L754	6200002581	S.COI NLV25T-033J	T	17.0/22.5
L755	6200003891	S.COI NLV25T-027J	T	14.2/24.2
L756	6200003891	S.COI NLV25T-027J	T	11.5/23.5
L757	6200003881	S.COI NLV25T-022J	T	8.7/24.2
L758	6200002611	S.COI NLV25T-R47J	T	4.0/22.3
L801	6200002181	S.COI NLV25T-R12J	T	28.4/17.6
L803	6200005711	S.COI ELJRE 27NGFA	T	26.3/17.6
L804	6200009070	S.COI LQW18AN18NG00D (LQW1608A18NG00)	T	25.1/15.6
L805	6200009220	S.COI LQW18AN15NG00D (LQW1608A15NG00)	T	23.2/15.0
L806	6200005641	S.COI ELJRE 6N8ZFA	T	21.6/19.0
L807	6200009670	S.COI MLG1608B 12NJ-T	T	18.7/18.3
L808	6200004720	S.COI MLF1608D R10K-T	T	18.0/10.1
L812	6200005711	S.COI ELJRE 27NGFA	T	14.9/14.5
L813	6200009070	S.COI LQW18AN18NG00D (LQW1608A18NG00)	T	15.8/17.3
L814	6200009220	S.COI LQW18AN15NG00D (LQW1608A15NG00)	T	13.9/18.3
L815	6200005641	S.COI ELJRE 6N8ZFA	T	10.1/18.1
L816	6200010700	S.COI LQW18AN12NG00D	T	6.6/17.9
L818	6200002181	S.COI NLV25T-R12J	T	4.6/17.0
L851	6200002181	S.COI NLV25T-R12J	B	26.8/30.8
L852	6200002611	S.COI NLV25T-R47J	B	26.4/34.1
L853	6200002181	S.COI NLV25T-R12J	B	3.4/22.8
L854	6200002611	S.COI NLV25T-R47J	B	5.4/26.0
L901	6200007420	S.COI ELJFC 101K-F	B	3.8/66.0
L953	6200002041	S.COI NLV25T-101J	B	56.5/44.6
L954	6200002041	S.COI NLV25T-101J	B	55.8/42.1
L955	6200002041	S.COI NLV25T-101J	B	55.9/39.6
L956	6200002041	S.COI NLV25T-101J	B	56.1/37.1
L957	6200002041	S.COI NLV25T-101J	B	56.0/34.6
L959	6200011300	S.COI EXCML16A270U	T	54.9/34.3
L960	6200002041	S.COI NLV25T-101J	B	56.7/30.3
L962	6200011300	S.COI EXCML16A270U	B	59.2/32.2
L963	6200011300	S.COI EXCML16A270U	B	60.4/32.2
L1001	6200003241	S.COI NLV32T-221J	B	53.7/50.9
L1002	6200003241	S.COI NLV32T-221J	B	47.9/55.0
L1103	6200002041	S.COI NLV25T-101J	B	42.2/61.2
L1105	6200002041	S.COI NLV25T-101J	B	40.8/71.8
L1106	6200002041	S.COI NLV25T-101J	T	36.4/62.3
L1107	6200002041	S.COI NLV25T-101J	B	34.9/74.7
L1110	6200002041	S.COI NLV25T-101J	T	32.4/62.3
L1111	6200002041	S.COI NLV25T-101J	B	26.1/69.8
L1112	6200002041	S.COI NLV25T-101J	T	29.9/62.3
L1152	6200003590	S.COI EXCCL3225U1	T	48.3/69.2
L1153	6200002041	S.COI NLV25T-101J	T	45.5/69.3
L1154	6200002041	S.COI NLV25T-101J	T	53.6/69.2
R2	7030007290	S.RES ERJ2GEJ 222 X (2.2K)	T	19.1/4.6
R3	7030005040	S.RES ERJ2GEJ 472 X (4.7K)	T	18.7/1.8
R4	7030004990	S.RES ERJ2GEJ 221 X (220)	T	22.2/2.6
R5	7030004980	S.RES ERJ2GEJ 101 X (100)	T	20.9/6.9
R8	7030003630	S.RES ERJ3GEYJ 393 V (39K)	B	13.7/7.2
R9	7030003610	S.RES ERJ3GEYJ 273 V (27K)	B	13.7/9.8

Eqv.= This component is equivalent to the REF No. component listed above, and may be substituted on parts orders and repairs.

[DDS UNIT]

REF NO.	PARTS NO.	DESCRIPTION	M.	H/V LOCATION
R10	7030005060	S.RES ERJ2GEJ 333 X (33K)	T	8.1/3.3
R11	7030001040	S.RES ERJ2GEJ-JPW	T	9.3/3.7
R51	7030005120	S.RES ERJ2GEJ 102 X (1K)	T	35.8/9.5
R52	7030005120	S.RES ERJ2GEJ 102 X (1K)	T	46.2/2.3
R53	7030005120	S.RES ERJ2GEJ 102 X (1K)	T	42.8/3.6
R54	7030005120	S.RES ERJ2GEJ 102 X (1K)	T	42.8/2.7
R61	7030005050	S.RES ERJ2GEJ 103 X (10K)	T	39.3/8.1
R62	7030005530	S.RES ERJ2GEJ 100 X (10)	T	49.3/23.2
R101	7030005000	S.RES ERJ2GEJ 471 X (470)	T	25.2/7.8
R102	7030004980	S.RES ERJ2GEJ 101 X (100)	T	22.1/7.4
R103	7030005570	S.RES ERJ2GEJ 820 X (82)	T	31.9/11.1
R104	7030004980	S.RES ERJ2GEJ 101 X (100)	T	33.1/11.6
R105	7030005570	S.RES ERJ2GEJ 820 X (82)	T	34.3/11.2
R106	7030005100	S.RES ERJ2GEJ 154 X (150K)	T	23.9/7.4
R121	7030005040	S.RES ERJ2GEJ 472 X (4.7K)	T	38.5/11.1
R150	7030005570	S.RES ERJ2GEJ 820 X (82)	T	45.9/10.7
R151	7030004980	S.RES ERJ2GEJ 101 X (100)	T	45.0/10.7
R154	7030005050	S.RES ERJ2GEJ 103 X (10K)	T	41.5/10.7
R155	7030005530	S.RES ERJ2GEJ 100 X (10)	T	46.3/11.2
R157	7030007270	S.RES ERJ2GEJ 151 X (150)	T	48.9/18.2
R158	7030009200	S.RES ERJ2GEJ 390 X (39)	T	48.0/16.8
R159	7030007270	S.RES ERJ2GEJ 151 X (150)	T	48.0/18.2
R160	7030005300	S.RES ERJ2GEJ 150 X (15)	T	44.2/16.0
R161	7030004980	S.RES ERJ2GEJ 101 X (100)	T	45.1/16.0
R162	7030005300	S.RES ERJ2GEJ 150 X (15)	T	45.0/14.7
R201	7030005530	S.RES ERJ2GEJ 100 X (10)	T	45.9/22.1
R202	7030000700	S.RES MCR10EZHZH 470 K (474)	T	45.7/18.8
R211	7030003400	S.RES ERJ3GEYJ 471 V (470)	B	37.3/17.3
R212	7030003440	S.RES ERJ3GEYJ 102 V (1K)	B	40.8/16.3
R213	7030003200	S.RES ERJ3GEYJ 100 V (10)	B	44.6/11.4
R214	7030003280	S.RES ERJ3GEYJ 470 V (47)	B	46.8/16.4
R301	7030005120	S.RES ERJ2GEJ 102 X (1K)	T	34.2/22.2
R303	7030010040	S.RES ERJ2GEJ-JPW	T	40.0/22.2
R304	7030005120	S.RES ERJ2GEJ 102 X (1K)	T	42.0/24.6
R305	7030005710	S.RES ERJ2GEJ 121 X (120)	T	44.2/29.0
R306	7030005120	S.RES ERJ2GEJ 102 X (1K)	T	31.6/25.7
R309	7030005120	S.RES ERJ2GEJ 102 X (1K)	T	31.2/29.5
R310	7030005120	S.RES ERJ2GEJ 102 X (1K)	T	31.3/30.5
R311	7030005120	S.RES ERJ2GEJ 102 X (1K)	T	31.3/31.5
R312	7030010040	S.RES ERJ2GEJ-JPW	T	32.9/31.7
R313	7030005710	S.RES ERJ2GEJ 121 X (120)	T	43.3/28.5
R314	7030009140	S.RES ERJ2GEJ 272 X (2.7K)	T	43.0/31.8
R315	7030005120	S.RES ERJ2GEJ 102 X (1K)	T	33.5/32.6
R316	7030005050	S.RES ERJ2GEJ 103 X (10K)	T	34.6/33.8
R317	7030004990	S.RES ERJ2GEJ 221 X (220)	T	43.9/31.8
R318	7030003860	S.RES ERJ3GE JPW V	B	35.8/28.4
R341	7030003440	S.RES ERJ3GEYJ 102 V (1K)	B	44.4/38.3
R342	7030003440	S.RES ERJ3GEYJ 102 V (1K)	B	46.0/41.2
R451	7030005120	S.RES ERJ2GEJ 102 X (1K)	T	44.6/46.3
R452	7030003860	S.RES ERJ3GE JPW V	B	48.6/44.6
R453	7030010090	S.RES ERJ2GEJ 180 X (18)	T	34.1/47.5
R454	7030008280	S.RES ERJ2GEJ 271 X (270)	T	32.9/47.1
R455	7030008280	S.RES ERJ2GEJ 271 X (270)	T	32.9/48.0
R456	7030010040	S.RES ERJ2GEJ-JPW	T	34.9/52.5
R457	7030005120	S.RES ERJ2GEJ 102 X (1K)	T	38.2/49.7
R458	7030004990	S.RES ERJ2GEJ 221 X (220)	T	31.6/43.6
R459	7030005090	S.RES ERJ2GEJ 104 X (100K)	T	42.1/50.0
R460	7030003680	S.RES ERJ3GEYJ 104 V (100K)	T	30.8/41.1
R461	7030005090	S.RES ERJ2GEJ 104 X (100K)	T	29.7/39.1
R462	7030003860	S.RES ERJ3GE JPW V	T	45.1/43.3
R463	7030003400	S.RES ERJ3GEYJ 471 V (470)	T	33.3/44.1
R464	7030004980	S.RES ERJ2GEJ 101 X (100)	T	40.8/49.8
R465	7030005570	S.RES ERJ2GEJ 820 X (82)	T	40.3/50.0
R467	7030005570	S.RES ERJ2GEJ 820 X (82)	T	40.8/48.8
R468	7030005570	S.RES ERJ2GEJ 820 X (82)	T	41.2/50.0
R469	7030003320	S.RES ERJ3GEYJ 101 V (100)	B	37.8/40.0
R471	7030005000	S.RES ERJ2GEJ 471 X (470)	T	41.7/37.7
R472	7030004990	S.RES ERJ2GEJ 221 X (220)	T	30.4/43.3
R473	7030007270	S.RES ERJ2GEJ 151 X (150)	T	31.8/34.5
R474	7030009200	S.RES ERJ2GEJ 390 X (39)	T	31.3/35.7
R475	7030007270	S.RES ERJ2GEJ 151 X (150)	T	30.1/35.4
R476	7030005000	S.RES ERJ2GEJ 471 X (470)	T	30.0/37.9
R477	7030003320	S.RES ERJ3GEYJ 101 V (100)	B	35.8/38.7
R501	7030003390	S.RES ERJ3GEYJ 391 V (390)	B	21.0/46.1
R502	7030009280	S.RES ERJ2GEJ 391 X	T	5.9/46.9
R503	7030005090	S.RES ERJ2GEJ 104 X (100K)	T	14.3/46.8
R505	7030005570	S.RES ERJ2GEJ 820 X (82)	T	6.5/48.6
R506	7030005570	S.RES ERJ2GEJ 820 X (82)	T	6.1/49.8
R507	7030005570	S.RES ERJ2GEJ 820 X (82)	T	5.6/48.6
R551	7030009280	S.RES ERJ2GEJ 391 X	T	23.1/42.0
R552	7030009280	S.RES ERJ2GEJ 391 X	T	6.3/42.0
R553	7030005090	S.RES ERJ2GEJ 104 X (100K)	T	10.1/41.6
R554	7030009200	S.RES ERJ2GEJ 390 X (39)	T	6.4/45.7
R555	7030007270	S.RES ERJ2GEJ 151 X (150)	T	7.2/44.5
R556	7030007270	S.RES ERJ2GEJ 151 X (150)	T	6.3/44.4
R601	7030008280	S		

DDS UNIT]

REF NO.	PARTS NO.	DESCRIPTION	M.	H/V LOCATION
R805	7030005570	S.RES ERJ2GEJ 820 X (82)	T	14.0/10.4
R806	7030005570	S.RES ERJ2GEJ 820 X (82)	T	14.3/11.7
R807	7030005570	S.RES ERJ2GEJ 820 X (82)	T	13.1/11.3
R808	7030003390	S.RES ERJ3GEYJ 391 V (390)	B	3.6/17.9
R810	7030005090	S.RES ERJ2GEJ 104 X (100K)	T	27.3/15.5
R841	7030005710	S.RES ERJ2GEJ 121 X (120)	T	21.2/12.6
R851	7030009280	S.RES ERJ2GEJ 391 X	T	27.1/37.3
R852	7030008280	S.RES ERJ2GEJ 271 X (270)	T	5.7/13.8
R853	7030010090	S.RES ERJ2GEJ 180 X (18)	T	6.9/14.0
R854	7030008280	S.RES ERJ2GEJ 271 X (270)	T	6.9/13.0
R855	7030003390	S.RES ERJ3GEYJ 391 V (390)	B	5.5/29.5
R901	7030005120	S.RES ERJ2GEJ 102 X (1K)	T	2.1/62.6
R902	7030005120	S.RES ERJ2GEJ 102 X (1K)	T	2.2/60.9
R903	7030005120	S.RES ERJ2GEJ 102 X (1K)	T	2.3/58.7
R951	7030003360	S.RES ERJ3GEYJ 221 V (220)	B	59.2/6.9
R952	7030004990	S.RES ERJ2GEJ 221 X (220)	T	54.1/9.3
R953	7030003360	S.RES ERJ3GEYJ 221 V (220)	B	59.5/3.3
R954	7030004990	S.RES ERJ2GEJ 221 X (220)	T	53.2/8.9
R955	7030004990	S.RES ERJ2GEJ 221 X (220)	T	55.3/7.8
R956	7030003360	S.RES ERJ3GEYJ 221 V (220)	B	59.2/4.9
R957	7030003360	S.RES ERJ3GEYJ 221 V (220)	B	56.6/5.0
R958	7030004990	S.RES ERJ2GEJ 221 X (220)	T	47.3/6.2
R959	7030003360	S.RES ERJ3GEYJ 221 V (220)	B	57.9/51.0
R960	7030003280	S.RES ERJ3GEYJ 470 V (47)	B	57.6/49.0
R961	7030004990	S.RES ERJ2GEJ 221 X (220)	T	54.6/11.7
R962	7030003860	S.RES ERJ3GE JPW V	T	51.4/21.0
R1051	7030003860	S.RES ERJ3GE JPW V	B	10.8/73.0
R1101	7030005120	S.RES ERJ2GEJ 102 X (1K)	T	40.6/52.2
R1102	7030005050	S.RES ERJ2GEJ 103 X (10K)	T	42.2/52.2
R1103	7030004980	S.RES ERJ2GEJ 101 X (100)	T	39.3/63.4
R1104	7030005050	S.RES ERJ2GEJ 103 X (10K)	T	44.2/51.3
R1105	7030004980	S.RES ERJ2GEJ 101 X (100)	T	38.7/60.9
R1106	7030007290	S.RES ERJ2GEJ 222 X (2.2K)	T	31.8/59.6
R1107	7030007290	S.RES ERJ2GEJ 222 X (2.2K)	T	28.1/59.6
R1108	7030005240	S.RES ERJ2GEJ 473 X (47K)	T	46.9/8.5
R1109	7030005240	S.RES ERJ2GEJ 473 X (47K)	T	47.9/8.5
C1	4030016950	S.CER C1005 JB 1A 473K-T	T	17.5/4.6
C2	4030017780	S.CER C1005 JB 1H 472K-T	T	20.9/5.0
C3	4030017510	S.CER C1005 CH 1H 680J-T	T	24.9/1.7
C4	4030017780	S.CER C1005 JB 1H 472K-T	T	22.4/4.6
C5	4030017680	S.CER C1005 CH 1H 820J-T	T	26.1/2.0
C6	4030017510	S.CER C1005 CH 1H 680J-T	T	27.3/1.7
C7	4030016930	S.CER C1005 JB 1A 104K-T	T	8.1/4.2
C8	4030016790	S.CER C1005 JB 1E 103K-T	T	10.1/5.7
C51	4030017780	S.CER C1005 JB 1H 472K-T	T	33.8/6.5
C52	4030017780	S.CER C1005 JB 1H 472K-T	T	36.1/5.3
C53	4030017780	S.CER C1005 JB 1H 472K-T	T	37.0/9.4
C54	4030016930	S.CER C1005 JB 1A 104K-T	T	34.9/4.5
C55	4510008580	S.ELE EEE0JA470SR	T	30.7/4.0
C56	4030016930	S.CER C1005 JB 1A 104K-T	T	34.9/2.9
C57	4030016930	S.CER C1005 JB 1A 104K-T	T	42.8/5.0
C58	4030016930	S.CER C1005 JB 1A 104K-T	T	41.0/5.9
C59	4030017720	S.CER C1005 JB 1H 331K-T	T	41.9/6.6
C60	4030017690	S.CER C1005 CH 1H 121J-T	T	42.2/7.8
C61	4030017720	S.CER C1005 JB 1H 331K-T	T	42.8/6.6
C62	4030016930	S.CER C1005 JB 1A 104K-T	T	35.7/6.5
C63	4030016930	S.CER C1005 JB 1A 104K-T	T	49.3/22.3
C64	4030017710	S.CER C1005 CH 1H 181J-T	T	34.7/6.5
C65	4030017710	S.CER C1005 CH 1H 181J-T	T	33.5/8.9
C101	4030017580	S.CER C1005 CH 1H 060C-T	T	26.5/8.7
C102	4030017660	S.CER C1005 CH 1H 330J-T	T	23.1/2.6
C104	4030017780	S.CER C1005 JB 1H 472K-T	T	20.9/7.8
C105	4030017460	S.CER C1005 JB 1H 102K-T	T	24.8/6.5
C120	4030017780	S.CER C1005 JB 1H 472K-T	T	37.3/11.6
C126	4030017780	S.CER C1005 JB 1H 472K-T	T	23.0/7.4
C150	4030017780	S.CER C1005 JB 1H 472K-T	T	44.1/10.7
C151	4030017780	S.CER C1005 JB 1H 472K-T	T	46.3/13.6
C152	4030017640	S.CER C1005 CH 1H 150J-T	T	43.3/16.0
C154	4030017660	S.CER C1005 CH 1H 330J-T	T	46.6/14.7
C155	4030017600	S.CER C1005 CH 1H 080C-T	T	46.4/16.8
C156	4030017660	S.CER C1005 CH 1H 330J-T	T	47.1/18.2
C157	4030007090	S.CER C1608 CH 1H 470J-T	B	53.0/15.3
C202	4030017590	S.CER C1005 CH 1H 070C-T	T	43.8/17.2
C203	4030007060	S.CER C1608 CH 1H 270J-T	B	37.8/16.0
C204	4030016930	S.CER C1005 JB 1A 104K-T	T	35.2/20.2
C206	4030017560	S.CER C1005 CH 1H 2R5B-T	T	43.4/21.7
C207	4030007110	S.CER C1608 CH 1H 680J-T	B	44.0/21.8
C208	4030009910	S.CER C1608 CH 1H 040B-T	B	40.9/21.8
C209	4030007060	S.CER C1608 CH 1H 270J-T	B	43.2/20.5
C210	4030009910	S.CER C1608 CH 1H 040B-T	B	40.8/19.8
C211	4030017460	S.CER C1005 JB 1H 102K-T	T	42.2/17.6
C216	4030017780	S.CER C1005 JB 1H 472K-T	T	46.3/20.9
C217	4030007120	S.CER C1608 CH 1H 820J-T	B	43.9/19.2
C218	4030011770	S.CER C1608 CH 1H 060B-T	B	43.2/17.9
C219	4030007010	S.CER C1608 CH 1H 100D-T	B	46.3/17.8
C221	4030006880	S.CER C1608 JB 1H 472K-T	B	46.1/15.1
C222	4030009910	S.CER C1608 CH 1H 040B-T	B	40.8/14.7
C223	4030006880	S.CER C1608 JB 1H 472K-T	B	46.0/13.5
C224	4030018630	S.CER C2012 CH 1H 472J-T	B	39.3/11.5
C225	4030006860	S.CER C1608 JB 1H 102K-T	B	38.5/19.4
C251	4030011600	S.CER C1608 JB 1E 104K-T	B	27.6/12.2
C252	4030011600	S.CER C1608 JB 1E 104K-T	B	28.7/23.5
C253	4550008160	S.TAN F931A226MAA [EUR]	B	29.6/21.7
Eqv.	4550007090	S.TAN TEESVA 1A 226M8R [EUR]		
C253	4550007090	S.TAN TEESVA 1A 226M8R [FRA]	B	29.6/21.7
Eqv.	4550008160	S.TAN F931A226MAA [FRA]		
C253	4550007090	S.TAN TEESVA 1A 226M8R [ESP]	B	29.6/21.7
Eqv.	4550008160	S.TAN F931A226MAA [ESP]		
C253	4550008160	S.TAN F931A226MAA [USA]	B	29.6/21.7
Eqv.	4550007090	S.TAN TEESVA 1A 226M8R [USA]		
C253	4550007090	S.TAN TEESVA 1A 226M8R [ITR]	B	29.6/21.7
Eqv.	4550008160	S.TAN F931A226MAA [ITR]		

Eqv.= This component is equivalent to the REF No. component listed above, and may be substituted on parts orders and repairs.

[DDS UNIT]

REF NO.	PARTS NO.	DESCRIPTION	M.	H/V LOCATION
C253	4550008160	S.TAN F931A226MAA [UK]	B	29.6/21.7
Eqv.	4550007090	S.TAN TEESVA 1A 226M8R [UK]		
C253	4550007090	S.TAN TEESVA 1A 226M8R [KOR]	B	29.6/21.7
Eqv.	4550008160	S.TAN F931A226MAA [KOR]		
C253	4550007090	S.TAN TEESVA 1A 226M8R [AUS]	B	29.6/21.7
Eqv.	4550008160	S.TAN F931A226MAA [AUS]		
C253	4550008160	S.TAN F931A226MAA [CHN]	B	29.6/21.7
Eqv.	4550007090	S.TAN TEESVA 1A 226M8R [CHN]		
C254	4030011600	S.CER C1608 JB 1E 104K-T	B	29.2/12.2
C255	4550008160	S.TAN F931A226MAA [EUR]	B	29.5/19.3
Eqv.	4550007090	S.TAN TEESVA 1A 226M8R [EUR]		
C255	4550007090	S.TAN TEESVA 1A 226M8R [FRA]	B	29.5/19.3
Eqv.	4550008160	S.TAN F931A226MAA [FRA]		
C255	4550007090	S.TAN TEESVA 1A 226M8R [ESP]	B	29.5/19.3
Eqv.	4550008160	S.TAN F931A226MAA [ESP]		
C255	4550008160	S.TAN F931A226MAA [USA]	B	29.5/19.3
Eqv.	4550007090	S.TAN TEESVA 1A 226M8R [USA]		
C255	4550007090	S.TAN TEESVA 1A 226M8R [ITR]	B	29.5/19.3
Eqv.	4550008160	S.TAN F931A226MAA [ITR]		
C255	4550008160	S.TAN F931A226MAA [UK]	B	29.5/19.3
Eqv.	4550007090	S.TAN TEESVA 1A 226M8R [UK]		
C255	4550007090	S.TAN TEESVA 1A 226M8R [KOR]	B	29.5/19.3
Eqv.	4550008160	S.TAN F931A226MAA [KOR]		
C255	4550007090	S.TAN TEESVA 1A 226M8R [AUS]	B	29.5/19.3
Eqv.	4550008160	S.TAN F931A226MAA [AUS]		
C255	4550008160	S.TAN F931A226MAA [CHN]	B	29.5/19.3
Eqv.	4550007090	S.TAN TEESVA 1A 226M8R [CHN]		
C302	4030016930	S.CER C1005 JB 1A 104K-T	T	36.2/22.2
C303	4030016930	S.CER C1005 JB 1A 104K-T	T	37.3/22.3
C304	4030016930	S.CER C1005 JB 1A 104K-T	T	38.2/22.2
C305	4030016930	S.CER C1005 JB 1A 104K-T	T	39.1/22.2
C306	4030016930	S.CER C1005 JB 1A 104K-T	T	43.6/24.6
C307	4030016930	S.CER C1005 JB 1A 104K-T	T	31.2/28.4
C308	4030016930	S.CER C1005 JB 1A 104K-T	T	43.6/25.5
C309	4030016930	S.CER C1005 JB 1A 104K-T	T	43.1/26.7
C310	4030016930	S.CER C1005 JB 1A 104K-T	T	44.0/26.7
C312	4030016930	S.CER C1005 JB 1A 104K-T	T	43.5/30.6
C317	4030011600	S.CER C1608 JB 1E 104K-T	B	44.0/26.1
C318	4030006880	S.CER C1608 JB 1H 472K-T	B	39.3/25.5
C321	4030017500	S.CER C1005 CH 1H 560J-T	T	51.3/30.2
C323	4030017510	S.CER C1005 CH 1H 680J-T	T	48.6/33.4
C325	4030017660	S.CER C1005 CH 1H 330J-T	T	48.8/35.8
C326	4030017640	S.CER C1005 CH 1H 150J-T	T	53.1/32.1
C328	4030006880	S.CER C1608 JB 1H 472K-T	B	39.7/29.7
C331	4030017390	S.CER C1005 CH 1H 180J-T	T	46.6/44.6
C333	4030017670	S.CER C1005 CH 1H 390J-T	T	48.4/44.5
C335	4030017390	S.CER C1005 CH 1H 180J-T	T	50.2/44.5
C341	4030007130	S.CER C1608 CH 1H 101J-T	B	42.5/39.8
C342	4030007090	S.CER C1608 CH 1H 470J-T	B	43.8/42.1
C343	4030007140	S.CER C1608 CH 1H 121J-T	B	41.3/39.0
C344	4030007100	S.CER C1608 CH 1H 560J-T	B	42.8/34.3
C345	4030017660	S.CER C1005 CH 1H 330J-T	T	45.5/37.9
C346	4030017660	S.CER C1005 CH 1H 330J-T	T	45.8/39.7
C347	4030006860	S.CER C1608 JB 1H 102K-T	B	48.5/31.7
C401	4030017460	S.CER C1005 JB 1H 102K-T	T	51.1/44.5
C402	4030017460	S.CER C1005 JB 1H 102K-T	T	52.4/49.0
C403	4030017430	S.CER C1005 CH 1H 101J-T	T	48.0/46.1
C411	4030017400	S.CER C1005 CH 1H 220J-T	T	48.2/49.8
C412	4030017630	S.CER C1005 CH 1H 120J-T	T	47.7/47.3
C413	4030017400	S.CER C1005 CH 1H 220J-T	T	46.7/49.4
C451	4030017420	S.CER C1005 CH 1H 470J-T	T	40.2/46.6
C453	4030017460	S.CER C1005 JB 1H 102K-T	T	46.1/46.8
C454	4030017460	S.CER C1005 JB 1H 102K-T	T	35.3/48.0
C456	4030016930	S.CER C1005 JB 1A 104K-T	T	31.3/48.0
C457	4030017460	S.CER C1005 JB 1H 102K-T	T	35.3/47.1
C458	4030017460	S.CER C1005 JB 1H 102K-T	T	30.6/49.8
C459	4030017460	S.CER C1005 JB 1H 102K-T	T	27.1/50.6
C460	4030017780	S.CER C1005 JB 1H 472K-T	T	39.4/50.1
C461	4030006880	S.CER C1608 JB 1H 472K-T	T	30.8/42.3
C463	4030017420	S.CER C1005 CH 1H 470J-T	T	40.7/41.9
C464	4030017690	S.CER C1005 CH 1H 121J-T	T	41.5/40.3
C465	4030017400	S.CER C1005 CH 1H 220J-T	T	37.8/41.8
C466	4030017570	S.CER C1005 CH 1H 040B-T	T	38.1/40.6
C467	4030017400	S.CER C1005 CH 1H 220J-T	T	37.2/40.6
C468	4030017360	S.CER C1005 CH 1H 030B-T	T	29.1/48.0
C469	4030017370	S.CER C1005 CH 1H 3R5B-T	T	29.1/47.1
C470	4030017380	S.CER C1005 CH 1H 050B-T	T	29.1/46.2
C471	4030017380	S.CER C1005 CH 1H 050B-T	T	35.7/43.9

[DDS UNIT]

REF NO.	PARTS NO.	DESCRIPTION	M.	H/V LOCATION
C555	4030017670	S.CER C1005 CH 1H 390J-T	T	14.5/42.0
C556	4030017350	S.CER C1005 CH 1H 020B-T	T	14.0/43.2
C557	4030017420	S.CER C1005 CH 1H 470J-T	T	13.2/42.0
C558	4030017590	S.CER C1005 CH 1H 070C-T	T	10.0/43.2
C559	4030017420	S.CER C1005 CH 1H 470J-T	T	8.9/42.0
C560	4030017630	S.CER C1005 CH 1H 120J-T	T	8.4/43.2
C561	4030017660	S.CER C1005 CH 1H 330J-T	T	7.9/42.0
C562	4030017780	S.CER C1005 JB 1H 472K-T	T	5.0/45.4
C563	4030017780	S.CER C1005 JB 1H 472K-T	T	11.7/41.6
C601	4030017780	S.CER C1005 JB 1H 472K-T	T	24.7/39.9
C602	4030017400	S.CER C1005 CH 1H 220J-T	T	23.3/37.6
C603	4030017360	S.CER C1005 CH 1H 030B-T	T	21.9/37.8
C604	4030017630	S.CER C1005 CH 1H 120J-T	T	13.3/40.4
C605	4030017620	S.CER C1005 CH 1H 100C-T	T	11.7/40.4
C606	4030017660	S.CER C1005 CH 1H 330J-T	T	18.4/36.9
C607	4030017600	S.CER C1005 CH 1H 080C-T	T	17.8/38.1
C608	4030017650	S.CER C1005 CH 1H 270J-T	T	17.2/36.9
C609	4030017640	S.CER C1005 CH 1H 150J-T	T	16.2/38.1
C610	4030017640	S.CER C1005 CH 1H 150J-T	T	15.9/36.9
C611	4030017440	S.CER C1005 CH 1H 221J-T	T	12.2/39.5
C612	4030017510	S.CER C1005 CH 1H 680J-T	T	10.3/40.0
C613	4030017620	S.CER C1005 CH 1H 100C-T	T	8.2/40.1
C614	4030017640	S.CER C1005 CH 1H 150J-T	T	5.4/40.4
C615	4030017670	S.CER C1005 CH 1H 390J-T	T	6.9/40.0
C616	4030017780	S.CER C1005 JB 1H 472K-T	T	6.9/38.2
C617	4030017780	S.CER C1005 JB 1H 472K-T	T	22.0/36.4
C618	4030017650	S.CER C1005 CH 1H 270J-T	T	3.4/37.2
C651	4030017620	S.CER C1005 CH 1H 100C-T	T	24.6/34.8
C652	4030017450	S.CER C1005 JB 1H 271K-T	T	23.7/34.8
C653	4030017590	S.CER C1005 CH 1H 070C-T	T	21.7/35.2
C654	4030017680	S.CER C1005 CH 1H 820J-T	T	20.4/34.8
C655	4030017600	S.CER C1005 CH 1H 080C-T	T	19.2/35.2
C656	4030017420	S.CER C1005 CH 1H 470J-T	T	17.9/34.8
C657	4030017630	S.CER C1005 CH 1H 120J-T	T	16.5/35.2
C658	4030017340	S.CER C1005 CH 1H 010B-T	T	13.3/32.8
C659	4030017360	S.CER C1005 CH 1H 030B-T	T	9.4/32.6
C660	4030017640	S.CER C1005 CH 1H 150J-T	T	14.6/32.3
C661	4030017650	S.CER C1005 CH 1H 270J-T	T	12.8/31.6
C662	4030017400	S.CER C1005 CH 1H 220J-T	T	8.5/31.6
C663	4030017380	S.CER C1005 CH 1H 050B-T	T	8.0/32.8
C664	4030017460	S.CER C1005 JB 1H 102K-T	T	5.4/34.9
C665	4030017390	S.CER C1005 CH 1H 180J-T	T	7.6/31.6
C666	4030017780	S.CER C1005 JB 1H 472K-T	T	11.5/31.2
C701	4030017460	S.CER C1005 JB 1H 102K-T	T	25.1/29.4
C702	4030017640	S.CER C1005 CH 1H 150J-T	T	23.7/27.2
C703	4030017540	S.CER C1005 CH 1H R75B-T	T	22.3/27.5
C704	4030017650	S.CER C1005 CH 1H 270J-T	T	18.7/26.4
C705	4030017350	S.CER C1005 CH 1H 020B-T	T	18.2/27.7
C706	4030017400	S.CER C1005 CH 1H 220J-T	T	17.5/26.4
C707	4030017570	S.CER C1005 CH 1H 040B-T	T	16.6/27.7
C708	4030017390	S.CER C1005 CH 1H 180J-T	T	16.4/26.4
C709	4030017590	S.CER C1005 CH 1H 070C-T	T	14.0/30.0
C710	4030017500	S.CER C1005 CH 1H 560J-T	T	12.6/29.1
C711	4030017380	S.CER C1005 CH 1H 050B-T	T	12.0/30.0
C712	4030017500	S.CER C1005 CH 1H 560J-T	T	10.7/29.3
C713	4030017380	S.CER C1005 CH 1H 050B-T	T	9.5/29.6
C714	4030017710	S.CER C1005 CH 1H 181J-T	T	8.2/29.7
C715	4030017630	S.CER C1005 CH 1H 120J-T	T	7.0/29.4
C716	4030017780	S.CER C1005 JB 1H 472K-T	T	21.5/26.0
C717	4030017460	S.CER C1005 JB 1H 102K-T	T	5.4/29.4
C751	4030017590	S.CER C1005 CH 1H 070C-T	T	24.9/24.5
C752	4030017710	S.CER C1005 CH 1H 181J-T	T	24.0/24.5
C753	4030017380	S.CER C1005 CH 1H 050B-T	T	21.5/24.9
C754	4030017500	S.CER C1005 CH 1H 560J-T	T	20.5/24.0
C755	4030017380	S.CER C1005 CH 1H 050B-T	T	19.9/24.9
C756	4030017650	S.CER C1005 CH 1H 270J-T	T	18.7/24.4
C757	4030017600	S.CER C1005 CH 1H 080C-T	T	16.7/24.8
C758	4030017610	S.CER C1005 CH 1H 090C-T	T	15.0/21.9
C759	4030017530	S.CER C1005 CH 1H 0R5B-T	T	14.1/22.2
C760	4030017640	S.CER C1005 CH 1H 150J-T	T	13.2/21.9
C761	4030017350	S.CER C1005 CH 1H 020B-T	T	9.7/22.2
C762	4030017630	S.CER C1005 CH 1H 120J-T	T	8.6/21.2
C763	4030017360	S.CER C1005 CH 1H 030B-T	T	8.2/22.4
C764	4030017620	S.CER C1005 CH 1H 100C-T	T	7.7/21.2
C765	4030017460	S.CER C1005 JB 1H 102K-T	T	5.4/24.7
C766	4030017780	S.CER C1005 JB 1H 472K-T	T	11.9/20.8
C802	4030017590	S.CER C1005 CH 1H 070C-T	T	26.5/19.4
C803	4030017380	S.CER C1005 CH 1H 050B-T	T	25.2/18.9
C804	4030017570	S.CER C1005 CH 1H 040B-T	T	24.3/18.9
C806	4030017600	S.CER C1005 CH 1H 080C-T	T	24.3/17.2
C807	4030017360	S.CER C1005 CH 1H 030B-T	T	23.4/19.0
C808	4030017660	S.CER C1005 CH 1H 330J-T	T	23.0/16.8
C809	4030017570	S.CER C1005 CH 1H 040B-T	T	23.0/17.7
C810	4030017570	S.CER C1005 CH 1H 040B-T	T	21.7/16.7
C811	4030017590	S.CER C1005 CH 1H 070C-T	T	21.3/18.0
C812	4030017610	S.CER C1005 CH 1H 090C-T	T	20.8/16.7
C813	4030017350	S.CER C1005 CH 1H 020B-T	T	19.8/18.8
C814	4030017580	S.CER C1005 CH 1H 060C-T	T	19.8/17.1
C815	4030017460	S.CER C1005 JB 1H 102K-T	T	20.3/12.6
C816	4030017460	S.CER C1005 JB 1H 102K-T	T	15.2/10.8
C817	4030017730	S.CER C1005 JB 1H 471K-T	T	19.0/9.0
C824	4030017590	S.CER C1005 CH 1H 070C-T	T	13.1/13.1
C825	4030017380	S.CER C1005 CH 1H 050B-T	T	14.3/13.4
C826	4030017570	S.CER C1005 CH 1H 040B-T	T	13.1/15.1
C827	4030017620	S.CER C1005 CH 1H 100C-T	T	14.6/15.6
C828	4030017360	S.CER C1005 CH 1H 030B-T	T	13.9/16.5
C829	4030017660	S.CER C1005 CH 1H 330J-T	T	12.7/16.9
C830	4030017570	S.CER C1005 CH 1H 040B-T	T	11.8/17.7
C831	4030017570	S.CER C1005 CH 1H 040B-T	T	11.8/19.3
C832	4030017590	S.CER C1005 CH 1H 070C-T	T	10.3/19.1
C833	4030017610	S.CER C1005 CH 1H 090C-T	T	8.5/19.2
C834	4030017350	S.CER C1005 CH 1H 020B-T	T	8.0/17.9
C835	4030017580	S.CER C1005 CH 1H 060C-T	T	7.1/19.6
C838	4030017460	S.CER C1005 JB 1H 102K-T	T	5.4/19.6
C839	4030017780	S.CER C1005 JB 1H 472K-T	T	25.5/14.6

Eqv.= This component is equivalent to the REF No. component listed above, and may be substituted on parts orders and repairs.

[DDS UNIT]

REF NO.	PARTS NO.	DESCRIPTION	M.	H/V LOCATION
C840	4030017460	S.CER C1005 JB 1H 102K-T	T	6.6/15.7
C841	4030006860	S.CER C1608 JB 1H 102K-T	B	5.1/15.4
C851	4030017780	S.CER C1005 JB 1H 472K-T	T	4.5/14.0
C901	4030017780	S.CER C1005 JB 1H 472K-T	T	2.4/68.4
C902	4030017430	S.CER C1005 CH 1H 101J-T	T	16.0/53.3
C951	4030016930	S.CER C1005 JB 1A 104K-T	T	52.3/38.2
C952	4030011600	S.CER C1608 JB 1E 104K-T	T	58.3/47.0
C953	4030016930	S.CER C1005 JB 1A 104K-T	T	54.1/18.4
C954	4030017780	S.CER C1005 JB 1H 472K-T	T	54.2/28.1
C955	4030016930	S.CER C1005 JB 1A 104K-T	T	52.9/33.3
C956	4030016930	S.CER C1005 JB 1A 104K-T	T	49.2/21.0
C957	4030016930	S.CER C1005 JB 1A 104K-T	T	53.9/36.0
C958	4030017780	S.CER C1005 JB 1H 472K-T	T	52.9/34.2
C959	4030017780	S.CER C1005 JB 1H 472K-T	T	52.9/35.1
C960	4030016930	S.CER C1005 JB 1A 104K-T	T	53.5/39.0
C961	4030016930	S.CER C1005 JB 1A 104K-T	T	52.3/39.8
C962	4030016930	S.CER C1005 JB 1A 104K-T	T	52.3/44.6
C963	4030016930	S.CER C1005 JB 1A 104K-T	T	53.5/38.1
C964	4030017460	S.CER C1005 JB 1H 102K-T	T	55.0/44.8
C966	4030016930	S.CER C1005 JB 1A 104K-T	T	52.3/41.4
C967	4030016930	S.CER C1005 JB 1A 104K-T	T	52.3/43.0
C968	4030018960	S.CER C3216 JB 1C 106MT-N	B	42.1/44.0
C969	4030006880	S.CER C1608 JB 1H 472K-T	B	48.2/23.1
C972	4030018970	S.CER C3225 JB 1C 226MT-N	B	42.2/36.4
C973	4030018970	S.CER C3225 JB 1C 226MT-N	B	29.0/2.8
C974	4030018970	S.CER C3225 JB 1C 226MT-N	B	32.0/2.8
C975	4550008190	S.TAN F931C107MNC [EUR]	B	16.7/4.1
Eqv.	4550007140	S.TAN TEESVD 1C 107M12R [EUR]		
C975	4550007140	S.TAN TEESVD 1C 107M12R [FRA]	B	16.7/4.1
Eqv.	4550008190	S.TAN F931C107MNC [FRA]		
C975	4550007140	S.TAN TEESVD 1C 107M12R [ESP]	B	16.7/4.1
Eqv.	4550008190	S.TAN F931C107MNC [ESP]		
C975	4550008190	S.TAN F931C107MNC [USA]	B	16.7/4.1
Eqv.	4550007140	S.TAN TEESVD 1C 107M12R [USA]		
C975	4550007140	S.TAN TEESVD 1C 107M12R [ITR]	B	16.7/4.1
Eqv.	4550008190	S.TAN F931C107MNC [ITR]		
C975	4550008190	S.TAN F931C107MNC [UK]	B	16.7/4.1
Eqv.	4550007140	S.TAN TEESVD 1C 107M12R [UK]		
C975	4550007140	S.TAN TEESVD 1C 107M12R [KOR]	B	16.7/4.1
Eqv.	4550008190	S.TAN F931C107MNC [KOR]		
C975	4550007140	S.TAN TEESVD 1C 107M12R [AUS]	B	16.7/4.1
Eqv.	4550008190	S.TAN F931C107MNC [AUS]		
C975	4550008190	S.TAN F931C107MNC [CHN]	B	16.7/4.1
Eqv.	4550007140	S.TAN TEESVD 1C 107M12R [CHN]		
C976	4550008190	S.TAN F931C107MNC [EUR]	B	23.5/10.5
Eqv.	4550007140	S.TAN TEESVD 1C 107M12R [EUR]		
C976	4550007140	S.TAN TEESVD 1C 107M12R [FRA]	B	23.5/10.5
Eqv.	4550008190	S.TAN F931C107MNC [FRA]		
C976	4550007140	S.TAN TEESVD 1C 107M12R [ESP]	B	23.5/10.5
Eqv.	4550008190	S.TAN F931C107MNC [ESP]		
C976	4550008190	S.TAN F931C107MNC [USA]	B	23.5/10.5
Eqv.	4550007140	S.TAN TEESVD 1C 107M12R [USA]		
C976	4550007140	S.TAN TEESVD 1C 107M12R [ITR]	B	23.5/10.5
Eqv.	4550008190	S.TAN F931C107MNC [ITR]		
C976	4550008190	S.TAN F931C107MNC [UK]	B	23.5/10.5
Eqv.	4550007140	S.TAN TEESVD 1C 107M12R [UK]		
C976	4550007140	S.TAN TEESVD 1C 107M12R [KOR]	B	23.5/10.5
Eqv.	4550008190	S.TAN F931C107MNC [KOR]		
C976	4550007140	S.TAN TEESVD 1C 107M12R [AUS]	B	23.5/10.5
Eqv.	4550008190	S.TAN F931C107MNC [AUS]		
C976	4550008190	S.TAN F931C107MNC [CHN]	B	23.5/10.5
Eqv.	4550007140	S.TAN TEESVD 1C 107M12R [CHN]		
C977	4550008190	S.TAN F931C107MNC [EUR]	B	23.6/19.5
Eqv.	4550007140	S.TAN TEESVD 1C 107M12R [EUR]		
C977	4550007140	S.TAN TEESVD 1C 107M12R [FRA]	B	23.6/19.5
Eqv.	4550008190	S.TAN F931C107MNC [FRA]		
C977	4550007140	S.TAN TEESVD 1C 107M12R [ESP]	B	23.6/19.5
Eqv.	4550008190	S.TAN F931C107MNC [ESP]		
C977	4550008190	S.TAN F931C107MNC [USA]	B	23.6/19.5
Eqv.	4550007140	S.TAN TEESVD 1C 107M12R [USA]		
C977	4550007140	S.TAN TEESVD 1C 107M12R [ITR]	B	23.6/19.5
Eqv.	4550008190	S.TAN F931C107MNC [ITR]		
C977	4550008190	S.TAN F931C107MNC [UK]	B	23.6/19.5
Eqv.	4550007140	S.TAN TEESVD 1C 107M12R [UK]		
C977	4550007			

[DDS UNIT]

REF NO.	PARTS NO.	DESCRIPTION	M.	H/V LOCATION
C994	4030006860	S.CER C1608 JB 1H 102K-T	B	5.6/71.4
C995	4030006860	S.CER C1608 JB 1H 102K-T	B	2.2/59.2
C996	4030006860	S.CER C1608 JB 1H 102K-T	B	5.1/58.8
C997	4030006860	S.CER C1608 JB 1H 102K-T	B	2.9/55.0
C998	4030006860	S.CER C1608 JB 1H 102K-T	B	3.1/62.6
C1001	4030011600	S.CER C1608 JB 1E 104K-T	T	58.4/48.4
C1051	4030006880	S.CER C1608 JB 1H 472K-T	B	20.2/65.4
C1052	4030006880	S.CER C1608 JB 1H 472K-T	B	19.2/60.3
C1101	4030017780	S.CER C1005 JB 1H 472K-T	T	39.0/52.2
C1102	4030017780	S.CER C1005 JB 1H 472K-T	T	44.2/50.4
C1104	4030017780	S.CER C1005 JB 1H 472K-T	T	42.2/62.2
C1105	4030017780	S.CER C1005 JB 1H 472K-T	T	40.6/59.9
C1106	4030017780	S.CER C1005 JB 1H 472K-T	T	40.4/55.9
C1107	4030017780	S.CER C1005 JB 1H 472K-T	T	43.3/57.0
C1108	4030017460	S.CER C1005 JB 1H 102K-T	T	40.1/62.2
C1109	4030006880	S.CER C1608 JB 1H 472K-T	B	35.1/76.9
C1110	4030017780	S.CER C1005 JB 1H 472K-T	T	33.5/59.6
C1111	4030017780	S.CER C1005 JB 1H 472K-T	T	29.7/59.6
C1112	4030017780	S.CER C1005 JB 1H 472K-T	T	38.2/63.4
C1113	4030017780	S.CER C1005 JB 1H 472K-T	T	37.1/59.7
C1114	4030017780	S.CER C1005 JB 1H 472K-T	T	24.4/60.7
C1115	4030017780	S.CER C1005 JB 1H 472K-T	T	35.3/59.8
C1116	4030017460	S.CER C1005 JB 1H 102K-T	T	23.2/63.8
C1117	4030006860	S.CER C1608 JB 1H 102K-T	B	21.0/63.9
C1151	4030017780	S.CER C1005 JB 1H 472K-T	T	50.5/66.3
C1152	4030017780	S.CER C1005 JB 1H 472K-T	T	46.4/66.3
C1153	4030017780	S.CER C1005 JB 1H 472K-T	T	43.7/68.2
C1154	4030017780	S.CER C1005 JB 1H 472K-T	T	52.0/66.3
C1155	4030017780	S.CER C1005 JB 1H 472K-T	T	57.9/68.3
RL1101	6330001721	REL ATN207-K1		
J151	6510028210	CON SJ050010 (TMP-J01X-V6)		
J851	6510018450	CON TMP-S01X-B1		
J951	6510024880	S.CON 52689-3087	T	59.3/35.4
J952	6510024880	S.CON 52689-3087	T	59.3/12.5
J1001	6510003521	CON S04B-EH-S(LF)(SN)		
J1051	6510028070	CON 01J0377-00		
J1101	6450001641	CON TCS5044-0141177		
J1151	6450001841	CON TCS7568-4320177		
EP6	6910012350	S.BEA MMZ1608Y 102BT	B	12.9/11.1
EP251	6910012350	S.BEA MMZ1608Y 102BT	B	33.1/18.7
EP301	6910012350	S.BEA MMZ1608Y 102BT	B	49.8/25.0
EP302	6910012350	S.BEA MMZ1608Y 102BT	B	32.9/27.8
EP303	6910012350	S.BEA MMZ1608Y 102BT	B	32.9/26.1
EP305	6910012350	S.BEA MMZ1608Y 102BT	B	41.1/27.2
EP306	6910012350	S.BEA MMZ1608Y 102BT	B	36.6/26.4
EP451	6910012350	S.BEA MMZ1608Y 102BT	B	39.9/47.9
EP809	6910012350	S.BEA MMZ1608Y 102BT	B	16.7/7.2
EP951	6910012350	S.BEA MMZ1608Y 102BT	B	53.3/24.4
EP952	6910012350	S.BEA MMZ1608Y 102BT	B	50.6/21.8
EP953	6910012350	S.BEA MMZ1608Y 102BT	T	54.0/43.4
EP954	6910012350	S.BEA MMZ1608Y 102BT	T	54.0/42.1
EP955	6910012350	S.BEA MMZ1608Y 102BT	T	54.2/40.0
EP956	6910012350	S.BEA MMZ1608Y 102BT	T	54.7/37.0
EP957	6910012350	S.BEA MMZ1608Y 102BT	B	39.6/46.1
EP958	6910012350	S.BEA MMZ1608Y 102BT	B	55.9/47.4
EP959	6910012350	S.BEA MMZ1608Y 102BT	B	56.7/32.5
EP960	6910012350	S.BEA MMZ1608Y 102BT	B	56.9/28.4
EP964	6910012350	S.BEA MMZ1608Y 102BT	B	53.4/22.2
EP981	6910012350	S.BEA MMZ1608Y 102BT	T	55.3/14.3
EP1003	6910018930	S.BEA MPZ2012S601A	T	57.3/50.3
EP1004	6910018930	S.BEA MPZ2012S601A	T	53.9/50.0
EP1051	6910012350	S.BEA MMZ1608Y 102BT	B	20.2/66.8
EP1052	6910012350	S.BEA MMZ1608Y 102BT	B	19.2/58.7
EP1100	6910012350	S.BEA MMZ1608Y 102BT	B	38.7/63.4
EP1101	6910012350	S.BEA MMZ1608Y 102BT	T	27.5/63.3
EP1102	6910012350	S.BEA MMZ1608Y 102BT	T	34.4/62.4
EP1103	6910012350	S.BEA MMZ1608Y 102BT	T	51.1/69.2
EP1104	6910012350	S.BEA MMZ1608Y 102BT	T	56.1/69.2
EP1105	6910014730	S.BEA MPZ2012S331A-T	B	41.0/67.9
EP1106	6910014730	S.BEA MPZ2012S331A-T	B	34.7/61.8
EP1107	6910014730	S.BEA MPZ2012S331A-T	B	31.4/61.8
EP1108	6910014730	S.BEA MPZ2012S331A-T	B	27.1/73.6

Eqv.= This component is equivalent to the REF No. component listed above, and may be substituted on parts orders and repairs.

M.=Mounted side (T: Mounted on the Top side, B: Mounted on the Bottom side)
S.=Surface mount

BOARD LAYOUTS

• LOGIC UNIT
(TOP VIEW)

J2101			
1	3V	EMU	2
	GND	TMS	
	GND	TCK	
	TDO	TRST	
9	GND	TDI	10

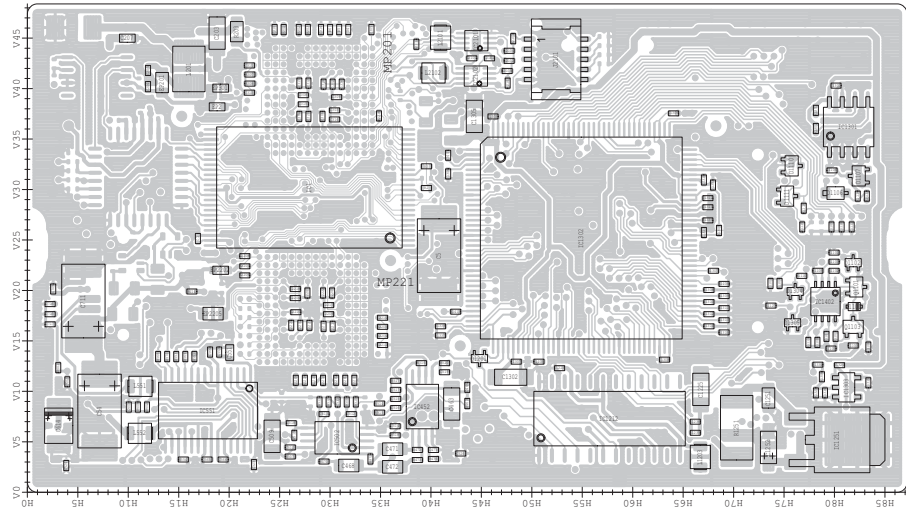

• PA UNIT
(TOP VIEW)

J980	
1	GND
2	FDAT
	MCK
	MST
	3R3V
	GND
	NC
	AT13
	THER
	TB1V
	TB2V
	PHT8
	PT8V
	ID4V
28	IDRV
	GND
	PRES
	GND
	HFOR
	P2R8
	P4R8
	PR4S
	PR3S
	2M8L
	VUFOR
	PT8V
	P4T8
	P2T8
27	

J2	
1	ID1V
	HCR8
	ICH
	ICI
	GND
	GND
	GND
	GND
	GND
	8V
	14V
	14V
	14V
	14V
	14V
2	
to MAIN unit J2004	
28	

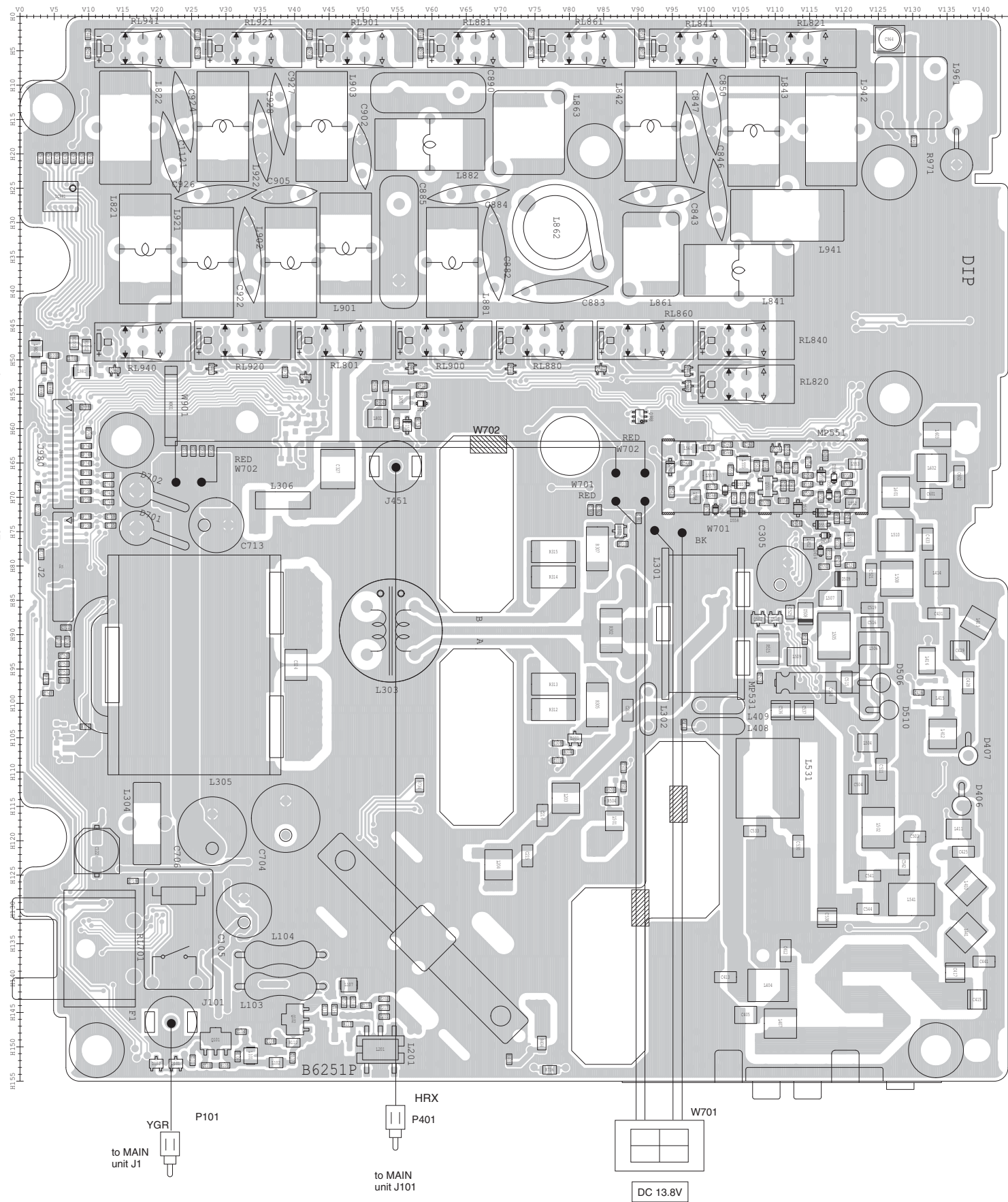

The combination of this side and the bottom side shows the board layout in the same configuration as the actual P.C.Board.

• PA UNIT
(BOTTOM VIEW)

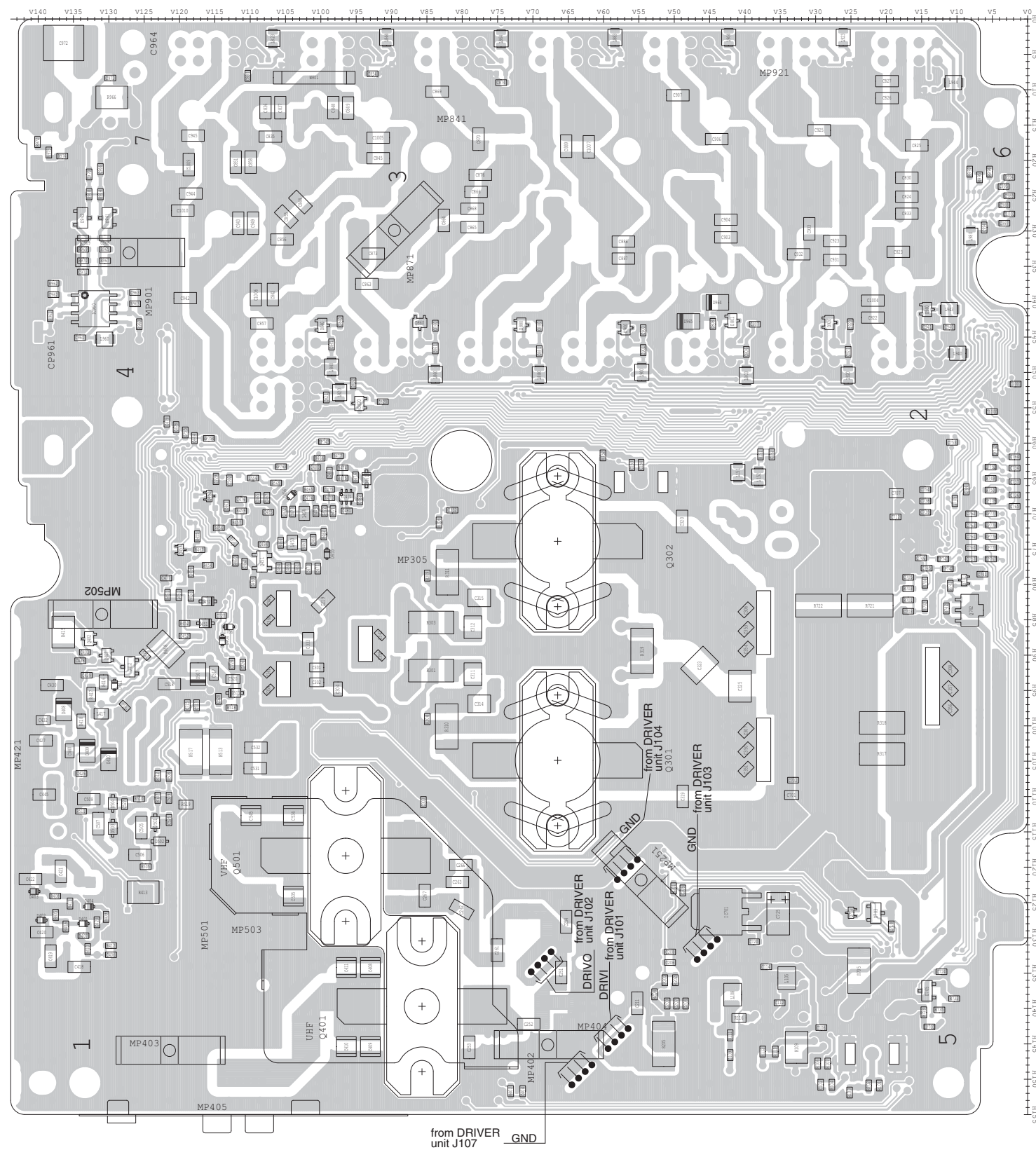

• LOGIC UNIT
(BOTTOM VIEW)

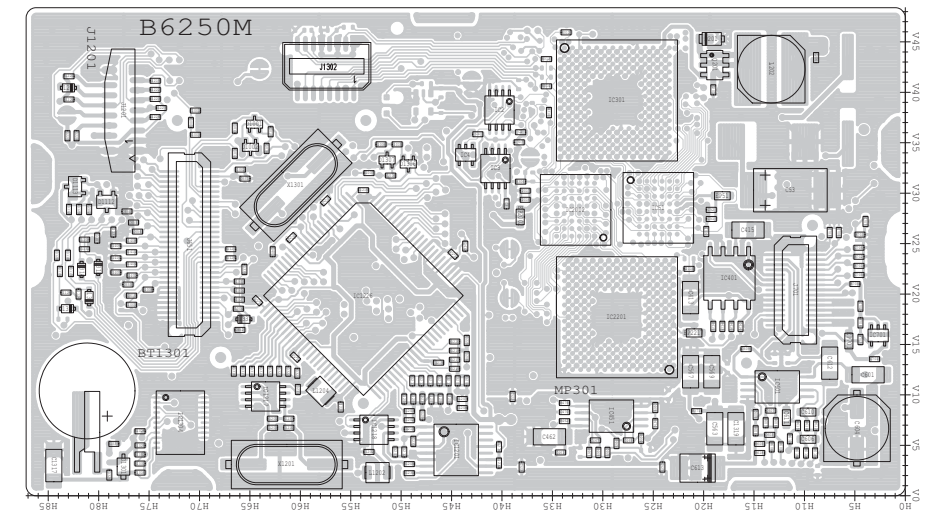

J651

60	1DST	VDL	1
	3DST	MMDK	
	PDT	SQSS	
	PCK	DOTK	
	TCNO	DASK	
	TCN1	WFML	
	PRES#	LTXD	
	LOST	LTXD	
	RS_RXD	CIV	
	RS_TXD	CIVE	
	MST	START	
	MDT	KEY	
	MCK	MUDL	
	NC	FOFL	
	SNDS	REFL	
	SDSS	ALCL	
	2TBV	SNDL	
	4TBV	DFTL	
	TXS	THML	
	RXS	CPU_P12	
	POWS	RTK1	
	VOUT	CPU_P22	
	PWRK	CPU_P94	
	GND	CPU_P95	
	GND	IMR	
	GND	CPU_PF6	
	GND	MMSL	
	GND	NC	
	GND	IMR2	
31	GND	NC	30

to MAIN unit J2252

J701

15	GND	AFMS	16
	DSP02	MOSI	
	GND	SCK	
	DSP01	VSTB	
	GND	NC	
	DOUT	NC	
	GND	NC	
	NC	24M	
	GND	HV	
	GND	8V	
	GND	8V	
	GND	5V	
	DSP11	5V	
	GND	3V	
1	DSP12	3V	30

to MAIN unit J2251

VOLTAGE DIAGRAM

• DISPLAY UNIT

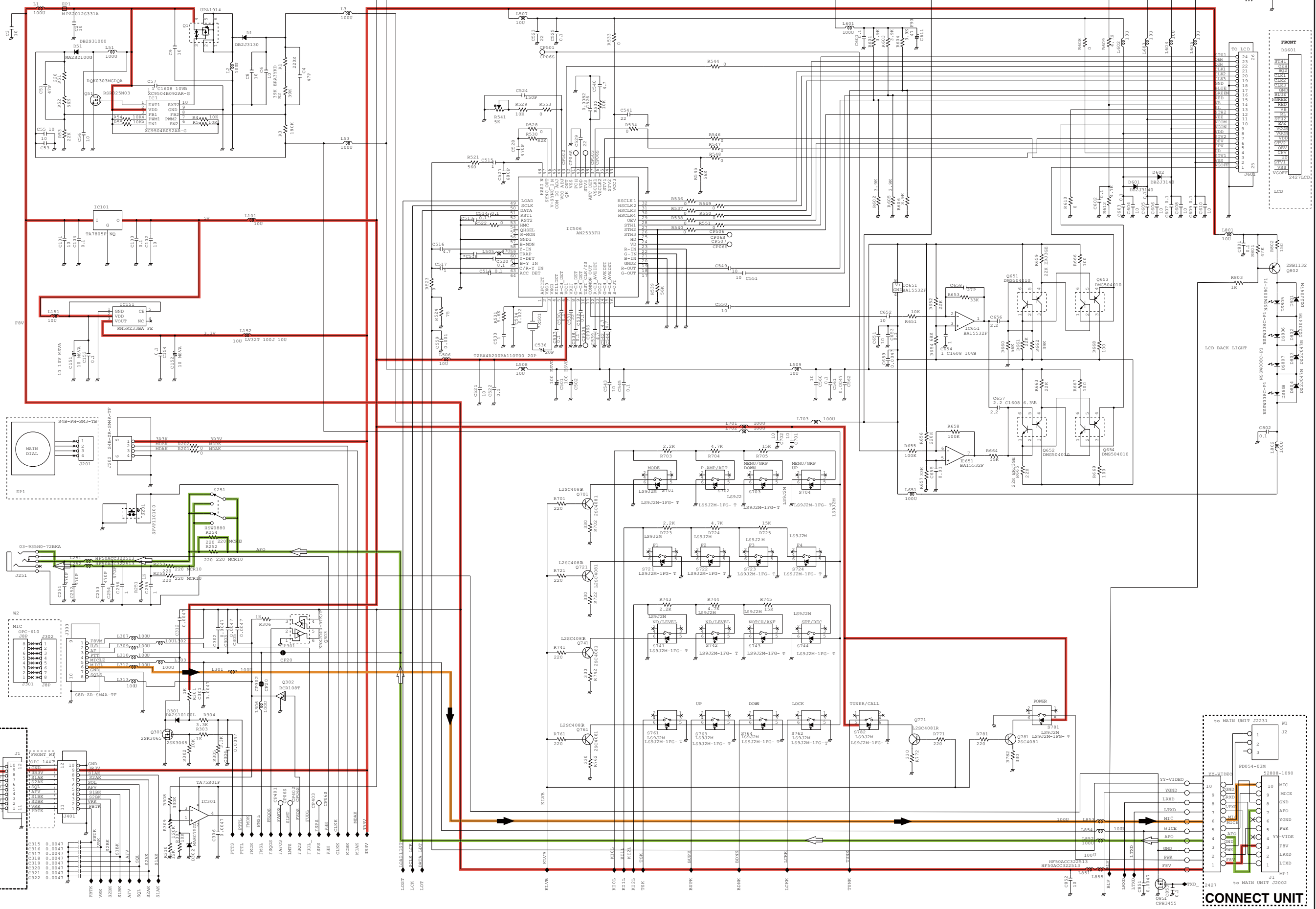

*; Refer to "PARTS LIST"

• LOGIC UNIT (1/3)

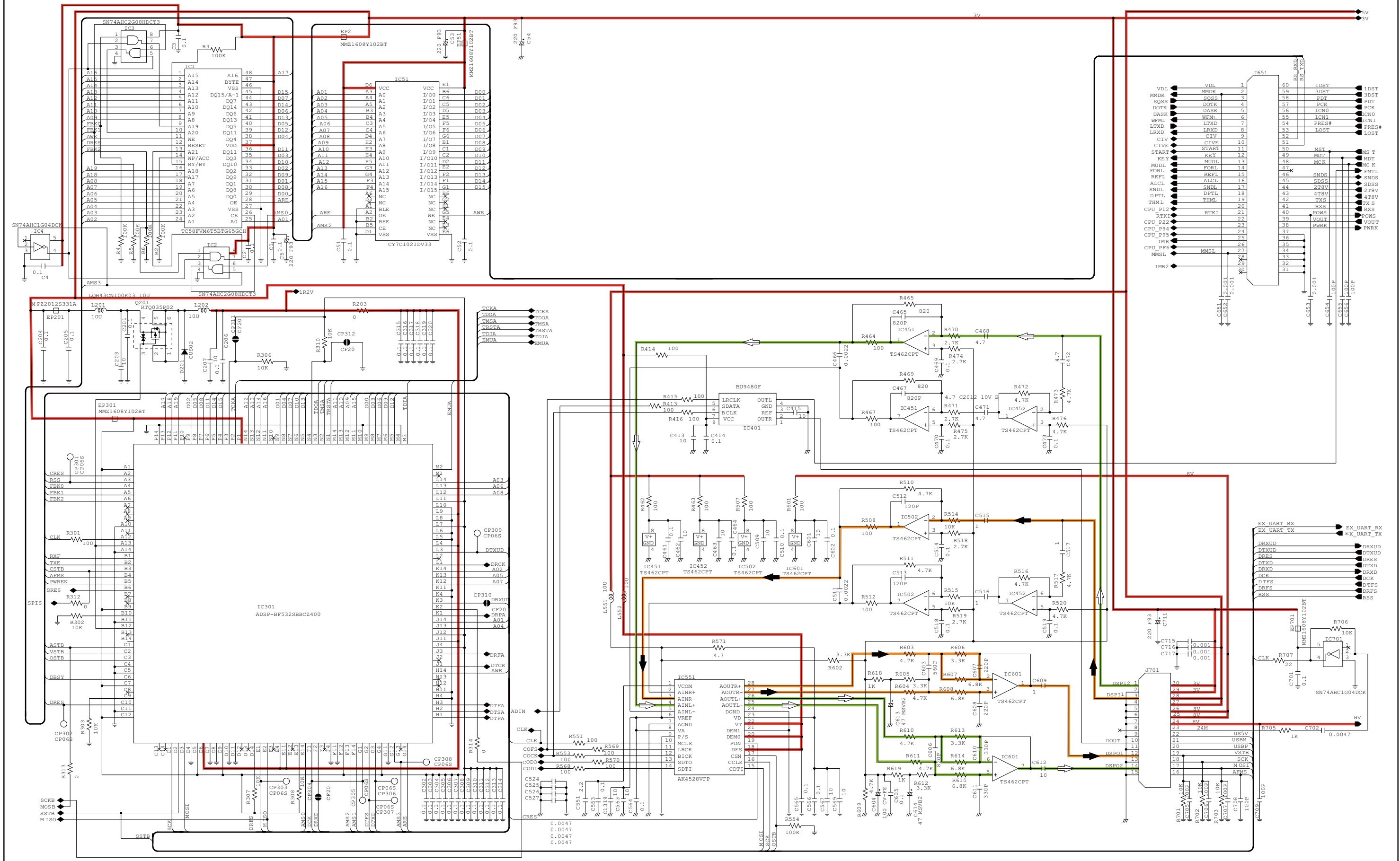

• MAIN UNIT (1/3)

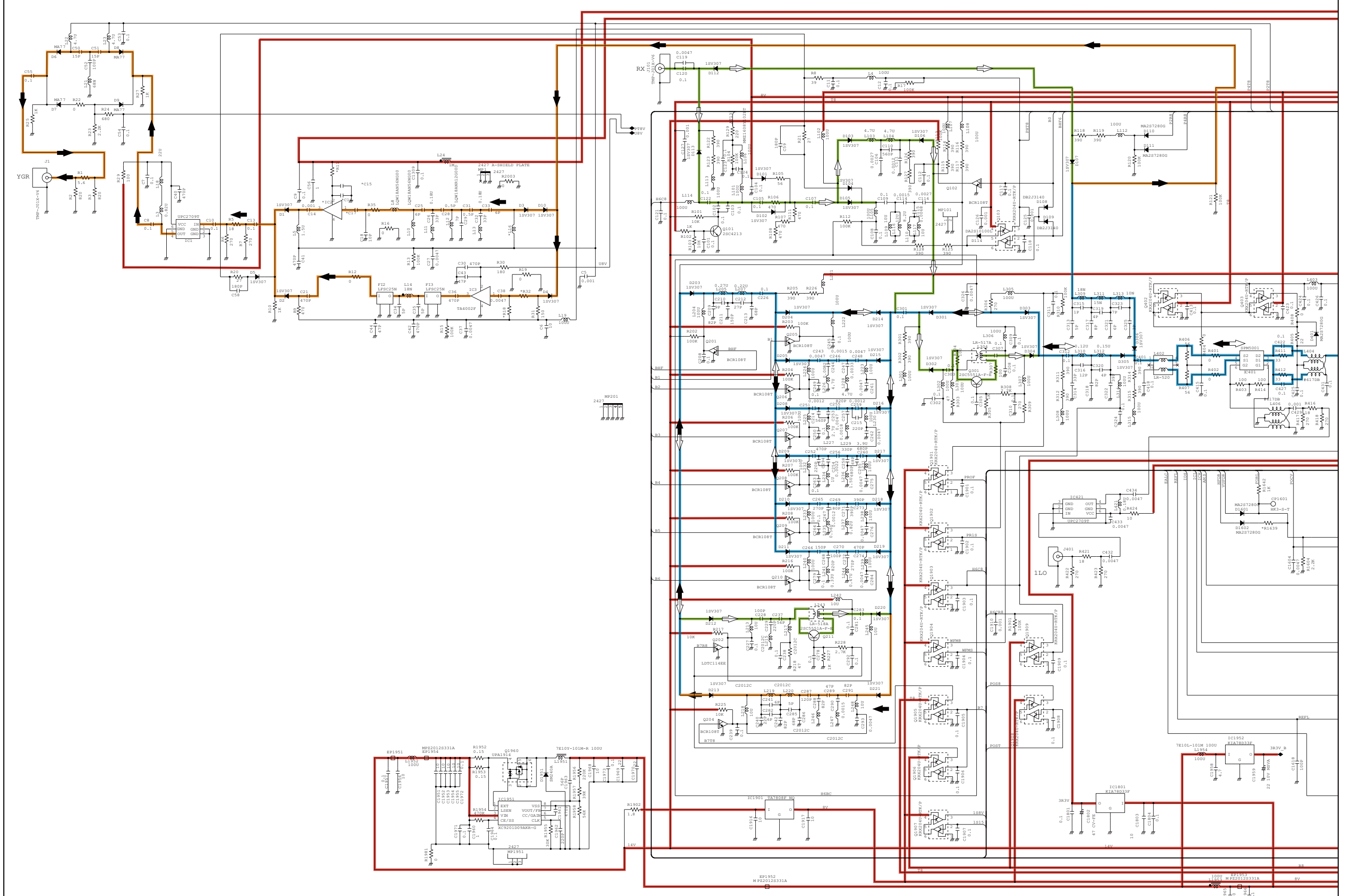

*; Refer to "PARTS LIST."

• MAIN UNIT (2/3)

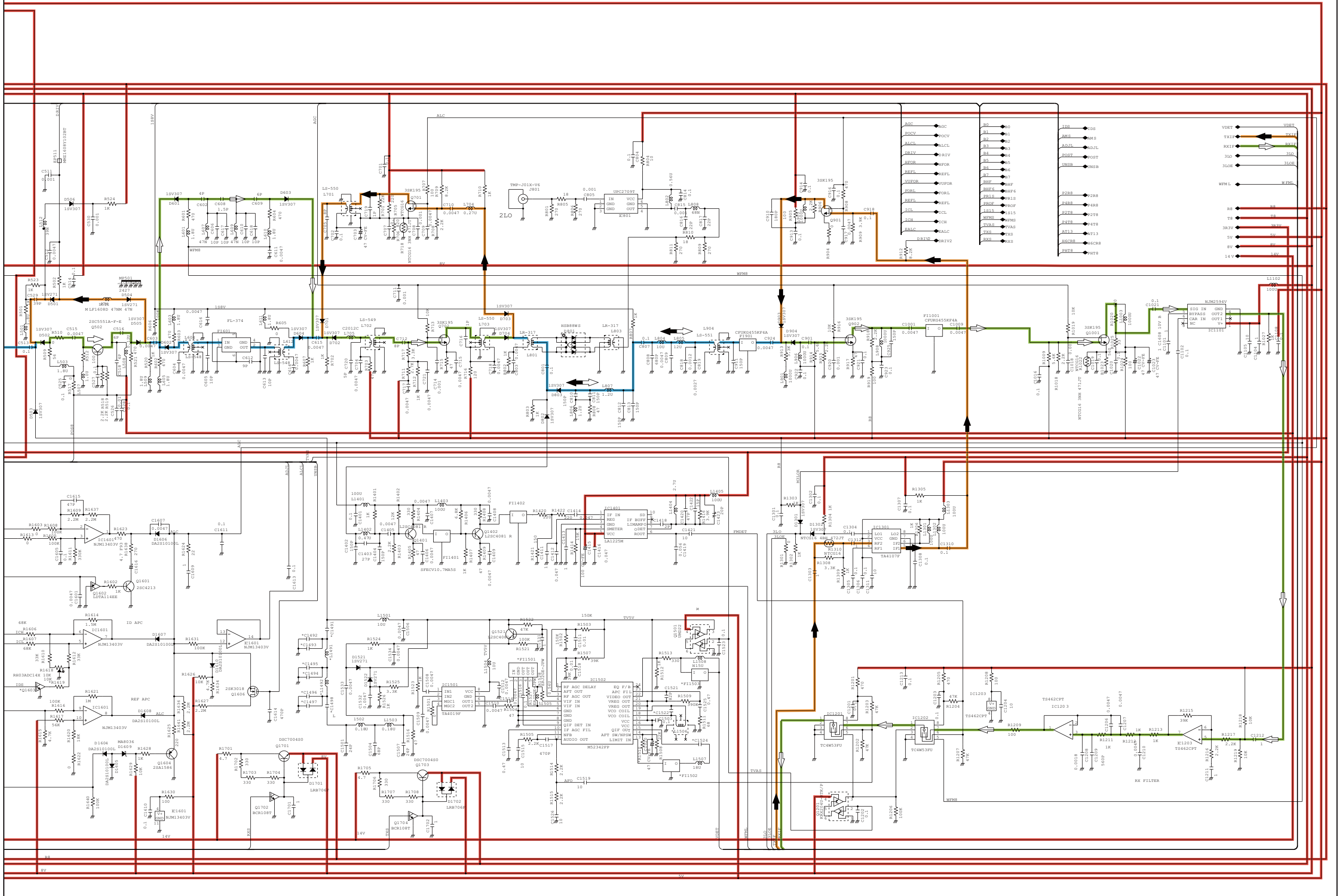

*; Refer to "PARTS LIST"

• MAIN UNIT (3/3)

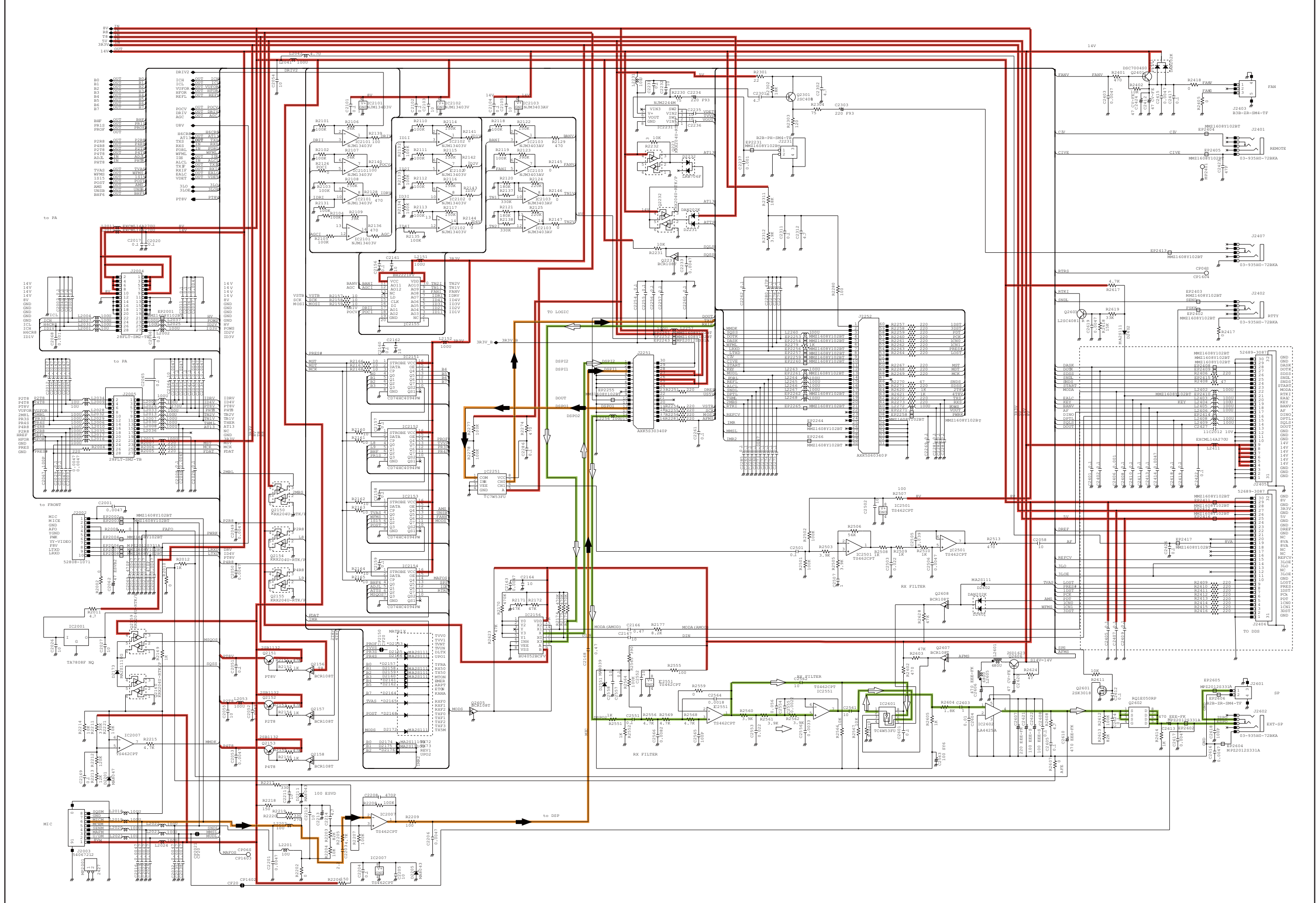

• PA UNIT (1/2)

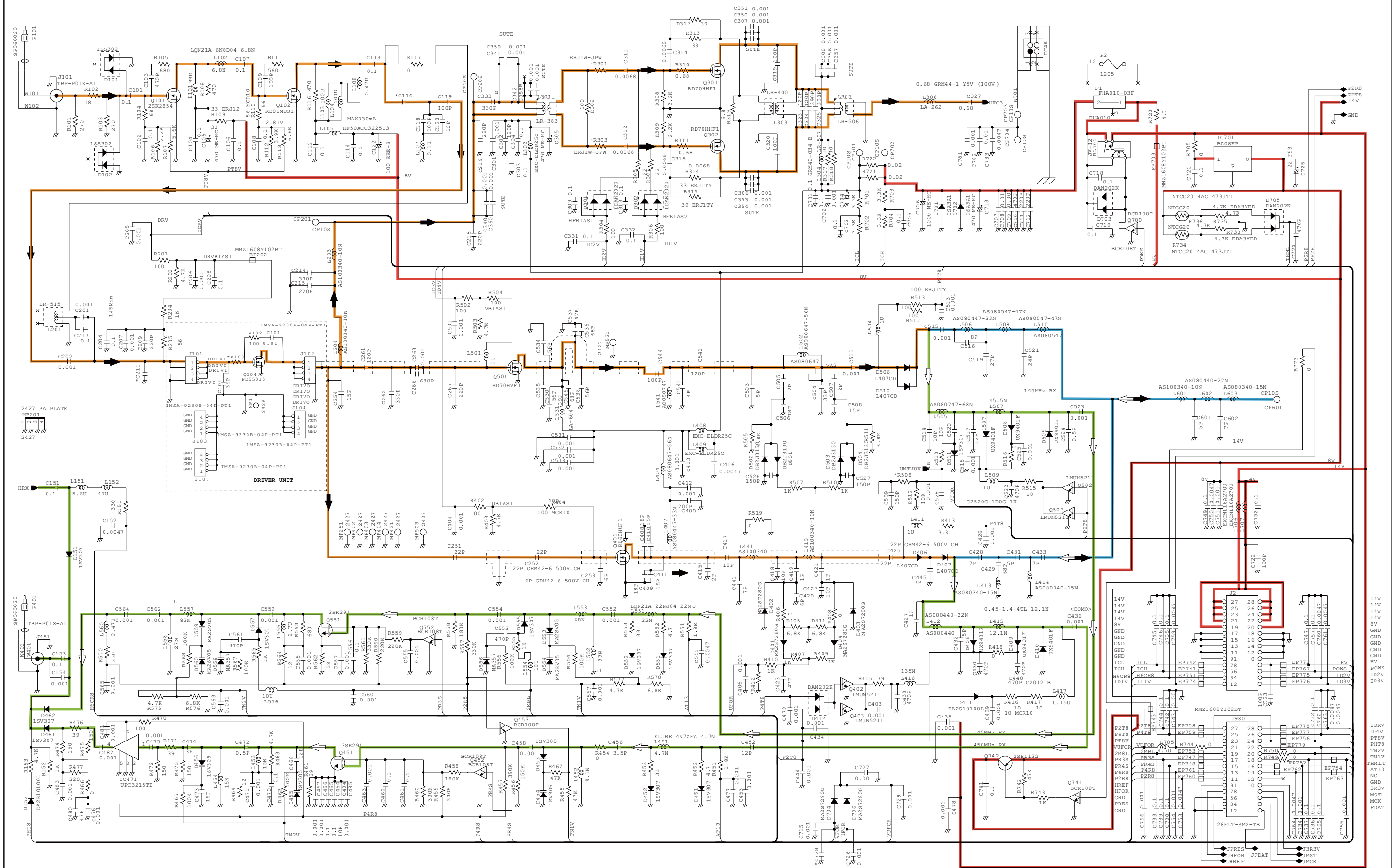

*, Refer to "PARTS LIST."

• DDS UNIT

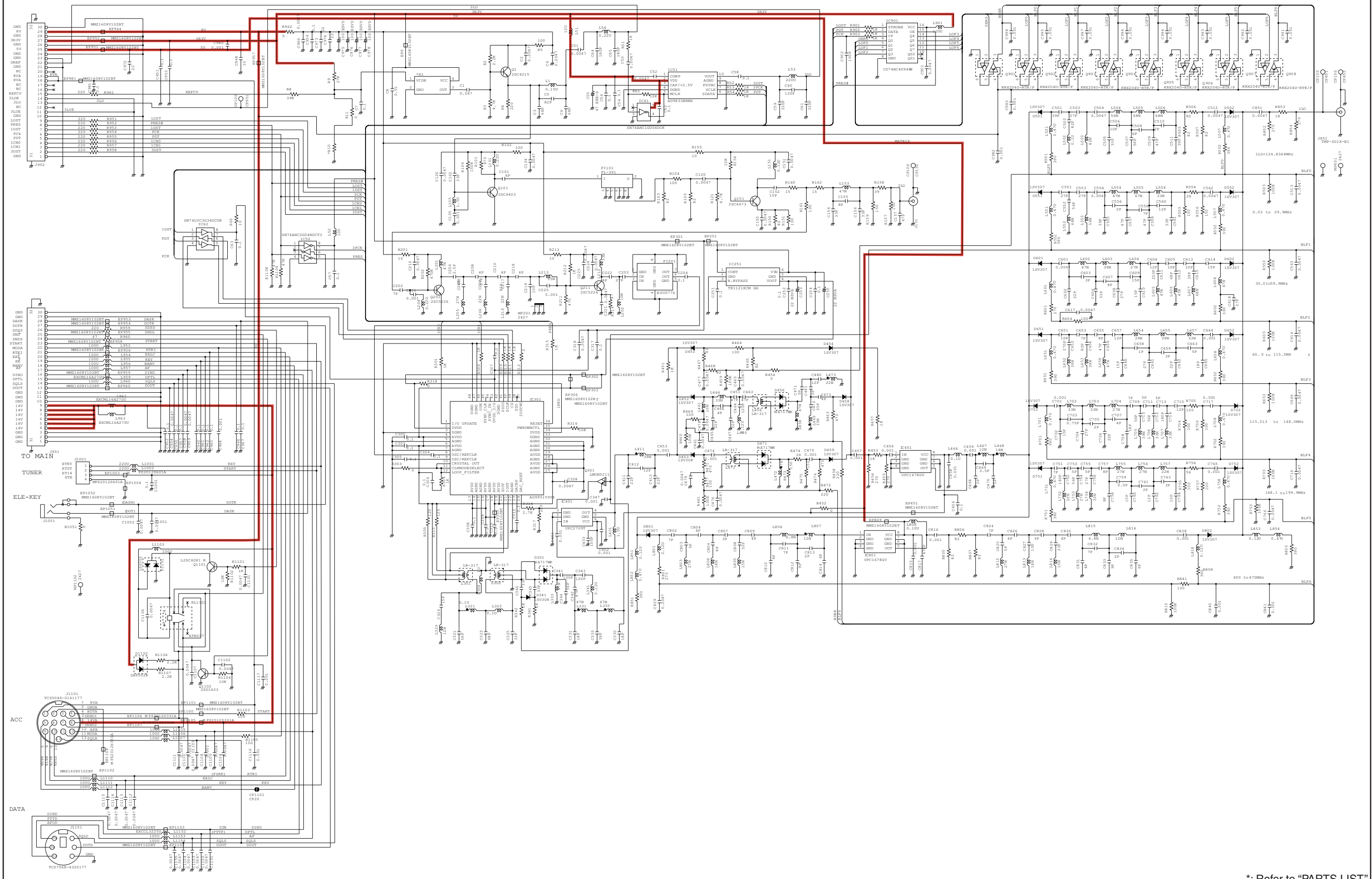

*; Refer to "PARTS LIST."

Jul. 2011



SERVICE MANUAL ADDENDUM

IC-7000

CONTENTS

PARTS LIST	1
BOARD LAYOUTS	27
VOLTAGE DIAGRAM	29

PARTS LIST

[MAIN UNIT]

REF NO.	PARTS NO.	DESCRIPTION	M.	H/V LOCATION
IC1	1110004080	S.IC UPC2709TE-E3	T	75.7/12.8
IC2	1110004101	S.IC TA4001F (TE85LF)	T	64.1/18.8
IC3	1110004091	S.IC TA4002F (TE85LF)	T	48.3/17.4
IC401	1190002051	S.IC SPM5001-TL-E [FRA]	T	77.5/27.9
	1190002051	S.IC SPM5001-TL-E [KOR]		
	1190002051	S.IC SPM5001-TL-E [AUS]		
	1190002052	S.IC SPM5001-TL-E (7000) [EUR]		
	1190002052	S.IC SPM5001-TL-E (7000) [ESP]		
	1190002052	S.IC SPM5001-TL-E (7000) [USA]		
	1190002052	S.IC SPM5001-TL-E (7000) [EXP]		
	1190002052	S.IC SPM5001-TL-E (7000) [ITR]		
	1190002052	S.IC SPM5001-TL-E (7000) [UK]		
	1190002052	S.IC SPM5001-TL-E (7000) [CHN]		
IC421	1110004080	S.IC UPC2709TE-E3	T	86.4/19.4
IC801	1110004080	S.IC UPC2709TE-E3	T	86.0/57.5
IC1101	1110006730	S.IC NJM2594V-TE1-#ZZZB	T	5.0/83.4
IC1201	1130006221	S.IC TC4W53FU(TE12LF)	T	24.2/81.6
IC1202	1130006221	S.IC TC4W53FU(TE12LF)	T	19.8/81.4
IC1203	1110006570	S.IC TS462CPT	T	12.8/81.8
IC1301	1110005461	S.IC TA4107F(TE12LF)	T	13.7/63.4
IC1401	1110006541	S.IC LA1225M-TLM-E	B	23.4/82.2
IC1501	1110006530	S.IC TA4019F(TE12LF)	B	74.9/39.1
IC1502	1110005040	S.IC M52342FP 600C	B	79.7/57.0
IC1601	1110005320	S.IC NJM13403V-TE1-#ZZZB	T	8.6/41.5
IC1801	1180002020	S.REG BA033FP-E2	B	22.9/106.6
IC1901	1180001252	S.IC TA7808F(TE16L1NQ)	B	10.4/55.2
IC1951	1190002120	S.IC XC9201D09AKR	B	42.0/107.8
IC1952	1180002020	S.REG BA033FP-E2	B	14.7/125.9
IC2001	1180001252	S.IC TA7808F(TE16L1NQ)	B	8.5/19.1
IC2007	1110006570	S.IC TS462CPT	T	15.9/121.0
IC2101	1110005320	S.IC NJM13403V-TE1-#ZZZB	T	28.5/118.1
IC2102	1110005320	S.IC NJM13403V-TE1-#ZZZB	T	49.5/111.9
IC2103	1110005140	S.IC NJM3403AV-TE1-#ZZZB	T	49.5/121.2
IC2151	1130012720	S.IC CD74HC4094PWR	T	47.2/95.9
IC2152	1130012720	S.IC CD74HC4094PWR	T	37.9/95.9
IC2153	1130012720	S.IC CD74HC4094PWR	T	28.1/95.9
IC2154	1130012720	S.IC CD74HC4094PWR	T	28.2/101.5
IC2155	1110006680	S.IC BH2221FV-E2	T	38.2/118.1
IC2156	1130009100	S.IC BU4052BCFV-E2	T	10.2/107.7
IC2231	1110006640	S.IC NJM2244M-TE1-#ZZZB	T	34.8/109.4
IC2251	1130008511	S.IC TC7W53FU(TE12LF)	T	16.8/89.6
IC2501	1110006570	S.IC TS462CPT	B	12.8/91.8
IC2551	1110006570	S.IC TS462CPT	B	49.3/122.0
IC2601	1130006221	S.IC TC4W53FU(TE12LF)	B	63.2/124.0
IC2602	1110003091	IC LA4425A-E		
Q101	1530003091	S.TRA 2SC4213-B(TE85RF)	T	11.2/17.5
Q102	1590003940	S.TRA RN1105(TE85LF)	T	20.7/5.6
Q103	1590003930	S.TRA UMD22N TR	T	38.4/20.2
Q201	1590003940	S.TRA RN1105(TE85LF)	T	16.2/31.2
Q202	1590002310	S.TRA DTC114EE TL	T	23.8/28.5
Q204	1590003940	S.TRA RN1105(TE85LF)	B	44.8/38.7
Q205	1590003940	S.TRA RN1105(TE85LF)	T	43.0/61.5
Q206	1590003940	S.TRA RN1105(TE85LF)	B	24.6/55.0
Q207	1590003940	S.TRA RN1105(TE85LF)	B	24.6/51.9
Q208	1590003940	S.TRA RN1105(TE85LF)	B	24.2/48.8
Q209	1590003940	S.TRA RN1105(TE85LF)	B	23.6/45.7
Q210	1590003940	S.TRA RN1105(TE85LF)	B	43.0/41.5
Q211	1530003852	S.TRA 2SC5551A-F-TD-E	T	27.6/30.2
Q301	1530003852	S.TRA 2SC5551A-F-TD-E	T	56.7/32.5
Q402	1590003930	S.TRA UMD22N TR	T	82.9/22.8
Q403	1590003930	S.TRA UMD22N TR	T	69.7/23.6
Q502	1530003852	S.TRA 2SC5551A-F-TD-E	T	83.1/37.1
Q701	1580000780	S.FET 3SK195(TE85LF)	T	62.1/56.6
Q702	1580000780	S.FET 3SK195(TE85LF)	T	54.7/51.9
Q901	1580000780	S.FET 3SK195(TE85LF)	T	36.6/65.7
Q902	1580000780	S.FET 3SK195(TE85LF)	T	35.9/73.2
Q1001	1580000780	S.FET 3SK195(TE85LF)	T	18.0/76.0
Q1201	1590003930	S.TRA UMD22N TR	T	28.1/78.7
Q1401	1530002060	S.TRA 2SC4081 T106 R	B	42.5/74.3
Q1402	1530002060	S.TRA 2SC4081 T106 R	B	36.7/80.1
Q1501	1590004030	S.TRA KRX204U-RTK/P	T	30.6/78.5
Q1521	1530002060	S.TRA 2SC4081 T106 R	B	86.0/47.6
Q1601	1530003091	S.TRA 2SC4213-B(TE85RF)	T	8.3/53.0
Q1602	1590001870	S.TRA DTA114EE TL	T	4.6/53.0
Q1603	1590003940	S.TRA RN1105(TE85LF)	T	2.8/40.8
Q1604	1510000771	S.TRA 2SA1586-GR(TE85LF)	T	5.1/32.7
Q1606	1560001260	S.FET 2SK3018 T106	T	12.6/36.9
Q1701	1540000441	S.TRA 2SD1619T-TD-E	B	52.4/48.3
Q1702	1590003940	S.TRA RN1105(TE85LF)	B	54.4/52.2
Q1703	1540000441	S.TRA 2SD1619T-TD-E	B	52.4/67.4
Q1704	1590003940	S.TRA RN1105(TE85LF)	B	54.1/72.9
Q1901	1590003930	S.TRA UMD22N TR	T	35.8/78.5
Q1902	1590003930	S.TRA UMD22N TR	T	33.3/78.5
Q1903	1590003930	S.TRA UMD22N TR	B	23.7/17.0
Q1904	1590003930	S.TRA UMD22N TR	B	33.0/88.0
Q1905	1590003930	S.TRA UMD22N TR	B	46.0/41.0
Q1906	1590003930	S.TRA UMD22N TR	B	26.3/30.9
Q1907	1590003930	S.TRA UMD22N TR	T	41.0/78.5
Q1908	1590003930	S.TRA UMD22N TR	T	38.4/78.5

[MAIN UNIT]

REF NO.	PARTS NO.	DESCRIPTION	M.	H/V LOCATION
Q1909	1590003930	S.TRA UMD22N TR	B	22.1/11.9
Q1960	1550000090	S.FET RSQ035P03TR	B	38.0/103.7
Q2150	1590003930	S.TRA UMD22N TR	T	48.5/100.1
Q2151	1520000460	S.TRA 2SB1132 T100 R	T	55.4/103.8
Q2152	1520000460	S.TRA 2SB1132 T100 R	T	21.4/111.1
Q2153	1520000460	S.TRA 2SB1132 T100 R	T	49.8/104.6
Q2154	1590003930	S.TRA UMD22N TR	T	44.7/100.1
Q2155	1590003930	S.TRA UMD22N TR	T	40.0/100.1
Q2156	1590003940	S.TRA RN1105(TE85LF)	T	58.9/104.5
Q2157	1590003940	S.TRA RN1105(TE85LF)	T	25.5/109.7
Q2158	1590003940	S.TRA RN1105(TE85LF)	T	45.6/107.1
Q2159	1590003930	S.TRA UMD22N TR	T	6.7/118.2
Q2160	1590003930	S.TRA UMD22N TR	T	7.7/122.2
Q2231	1590003940	S.TRA RN1105(TE85LF)	T	4.7/121.7
Q2232	1590003930	S.TRA UMD22N TR	T	57.4/114.8
Q2233	1590003930	S.TRA UMD22N TR	T	54.7/115.8
Q2301	1530002060	S.TRA 2SC4081 T106 R	T	30.6/109.1
Q2401	1540000441	S.TRA 2SD1619T-TD-E	B	80.2/26.4
Q2601	1560001260	S.FET 2SK3018 T106	B	36.2/124.7
Q2602	1560001221	S.FET ECH8301-TL-E	B	37.4/127.6
Q2603	1530002060	S.TRA 2SC4081 T106 R	T	65.4/111.4
Q2605	1590003940	S.TRA RN1105(TE85LF)	T	11.7/112.7
Q2606	1540000451	S.TRA 2SD1623T-TD-E	B	89.5/120.0
Q2607	1590003940	S.TRA RN1105(TE85LF)	B	65.5/120.5
Q2608	1590003940	S.TRA RN1105(TE85LF)	B	45.0/128.7
D1	1750000581	S.DIO 1SV307(TPH3F)	T	70.2/16.6
D2	1750000581	S.DIO 1SV307(TPH3F)	T	70.4/14.9
D3	1750000581	S.DIO 1SV307(TPH3F)	T	45.3/19.8
D4	1750000581	S.DIO 1SV307(TPH3F)	T	41.9/19.1
D5	1750000581	S.DIO 1SV307(TPH3F)	T	70.4/18.8
D6	1790000620	S.DIO MA77(TX)	B	79.9/17.1
D7	1790000620	S.DIO MA77(TX)	T	78.1/15.9
D8	1790000620	S.DIO MA77(TX)	B	81.6/10.6
D9	1790000620	S.DIO MA77(TX)	T	79.1/11.5
D10	1750000581	S.DIO 1SV307(TPH3F)	T	42.5/20.9
D101	1750000581	S.DIO 1SV307(TPH3F)	T	13.3/22.5
D102	1750000581	S.DIO 1SV307(TPH3F)	T	15.7/19.2
D103	1750000581	S.DIO 1SV307(TPH3F)	T	20.4/8.8
D104	1750000581	S.DIO 1SV307(TPH3F)	T	34.8/18.0
D105	1750000581	S.DIO 1SV307(TPH3F)	T	23.2/12.7
D106	1750000581	S.DIO 1SV307(TPH3F)	T	29.7/21.0
D107	1750000581	S.DIO 1SV307(TPH3F)	T	44.0/23.7
D108	1750000951	S.DIO MA2J7320GL	T	27.2/18.3
D109	1750000951	S.DIO MA2J7320GL	B	24.8/20.3
D110	1790001241	S.DIO MA2S7280GL	B	51.6/26.5
D111	1790001241	S.DIO MA2S7280GL	B	51.6/24.7
D112	1750000581	S.DIO 1SV307(TPH3F)	T	15.7/21.0
D113	1750000581	S.DIO 1SV307(TPH3F)	T	10.3/19.8
D114	1790001251	S.DIO MA2S1110GL	T	35.7/21.4
D203	1750000581	S.DIO 1SV307(TPH3F)	T	19.4/35.7
D204	1750000581	S.DIO 1SV307(TPH3F)	T	25.7/58.3
D205	1750000581	S.DIO 1SV307(TPH3F)	T	25.7/56.3
D208	1750000581	S.DIO 1SV307(TPH3F)	T	25.7/53.4
D209	1750000581	S.DIO 1SV307(TPH3F)	T	25.7/50.6
D210	1750000581	S.DIO 1SV307(TPH3F)	T	25.7/47.7
D211	1750000581	S.DIO 1SV307(TPH3F)	T	25.7/44.8
D212	1750000581	S.DIO 1SV307(TPH3F)	T	25.7/39.2
D213	1750000581	S.DIO 1SV307(TPH3F)	T	25.7/41.5
D214	1750000581	S.DIO 1SV307(TPH3F)	T	47.7/59.3
D215	1750000581	S.DIO 1SV307(TPH3F)	T	47.7/56.3
D216	1750000581	S.DIO 1SV307(TPH3F)	T	48.0/53.7
D217	1750000581	S.DIO 1SV307(TPH3F)	T	47.8/49.7
D218	1750000581	S.DIO 1SV307(TPH3F)	B	41.8/47.3
D219	1750000581	S.DIO 1SV307(TPH3F)	B	38.9/41.7
D220	1750000581	S.DIO 1SV307(TPH3F)	B	44.7/28.6
D221	1750000581	S.DIO 1SV307(TPH3F)	B	40.5/36.1
D301	1750000581	S.DIO 1SV307(TPH3F)	T	47.3/28.5
D302	1750000581	S.DIO 1SV307(TPH3F)	T	49.5/30.3
D303	1750000581	S.DIO 1SV307(TPH3F)	T	64.1/30.0
D304	1750000581	S.DIO 1SV307(TPH3F)	T	62.4/35.2
D305	1750000581	S.DIO 1SV307(TPH3F)	T	73.4/35.2
D306	1750000581	S.DIO 1SV307(TPH3F)	T	64.5/25.7
D401	1790001241	S.DIO MA2S7280GL	T	86.7/24.9
D501	1750000531	S.DIO 1SV271(TPH3F)	T	90.6/32.3
D502	1750000581	S.DIO 1SV307(TPH3F)	T	86.2/31.5
D503	1750000581	S.DIO 1SV307(TPH3F)	T	89.4/29.8
D504	1750000531	S.DIO 1SV271(TPH3F)	T	89.8/37.8
D505	1750000581	S.DIO 1SV307(TPH3F)	T	86.7/40.1
D506	1750000581	S.DIO 1SV307(TPH3F)	B	87.3/35.6
D601	1750000581	S.DIO 1SV307(TPH3F)	B	90.0/38.6
D602	1750000581	S.DIO 1SV307(TPH3F)	T	92.5/41.5
D603	1750000581	S.DIO 1SV307(TPH3F)	B	76.2/46.6
D604	1750000581	S.DIO 1SV307(TPH3F)	T	66.7/43.7
D701	1750000581	S.DIO 1SV307(TPH3F)	T	61.2/43.8
D702	1750000581	S.DIO 1SV307(TPH3F)	T	65.1/41.4
D703	1750000581	S.DIO 1SV307(TPH3F)	T	62.7/61.5
D704	1750000581	S.DIO 1SV307(TPH3F)	T	62.7/63.2
D801	1750000431	S.DIO HSB88W8TR-E	T	74.1/60.3
D802	1750000581	S.DIO 1SV307(TPH3F)	T	63.1/73.4

M.=Mounted side (T: Mounted on the Top side, B: Mounted on the Bottom side)
S.=Surface mount

[MAIN UNIT]

REF NO.	PARTS NO.	DESCRIPTION	M.	H/V LOCATION
D803	1750000581	S.DIO 1SV307(TPH3F)	T	65.5/64.6
D903	1750000581	S.DIO 1SV307(TPH3F)	T	39.5/69.4
D904	1750000581	S.DIO 1SV307(TPH3F)	T	39.5/72.8
D1301	1750000581	S.DIO 1SV307(TPH3F)	T	12.8/72.6
D1302	1750000581	S.DIO 1SV307(TPH3F)	T	13.9/70.9
D1521	1750000531	S.DIO 1SV271(TPH3F)	B	79.5/40.7
D1522	1750000531	S.DIO 1SV271(TPH3F)	B	79.5/42.5
D1601	1790001241	S.DIO MA2S7280GL	T	15.2/48.8
D1602	1790001241	S.DIO MA2S7280GL	T	18.3/53.2
D1604	1790001251	S.DIO MA2S1110GL	T	7.7/31.5
D1605	1790001251	S.DIO MA2S1110GL	T	7.7/32.8
D1606	1790001251	S.DIO MA2S1110GL	T	14.2/44.9
D1607	1790001251	S.DIO MA2S1110GL	T	14.2/43.6
D1608	1790001251	S.DIO MA2S1110GL	T	14.2/42.3
D1609	1790001331	S.ZEN MAZ8036GLL	T	7.5/29.9
D1610	1790001251	S.DIO MA2S1110GL	T	12.4/35.0
D1701	1790001670	S.DIO RB706F-40T106	B	50.3/52.2
D1702	1790001670	S.DIO RB706F-40T106	B	51.9/71.8
D1951	1750001110	S.DIO SM240A-T	B	36.3/100.0
D2151	1790001251	S.DIO MA2S1110GL [USA]	T	39.0/87.1
	1790001251	S.DIO MA2S1110GL [KOR]		
	1790001251	S.DIO MA2S1110GL [AUS]		
D2153	1790001251	S.DIO MA2S1110GL [USA]	T	36.5/87.1
	1790001251	S.DIO MA2S1110GL [KOR]		
D2154	1790001251	S.DIO MA2S1110GL	T	36.5/88.4
D2155	1790001251	S.DIO MA2S1110GL	T	36.6/89.7
D2156	1790001251	S.DIO MA2S1110GL	T	39.0/90.6
D2157	1790001251	S.DIO MA2S1110GL [EUR]	T	48.6/87.1
	1790001251	S.DIO MA2S1110GL [ESP]		
	1790001251	S.DIO MA2S1110GL [USA]		
	1790001251	S.DIO MA2S1110GL [EXP]		
	1790001251	S.DIO MA2S1110GL [ITR]		
	1790001251	S.DIO MA2S1110GL [UK]		
	1790001251	S.DIO MA2S1110GL [KOR]		
	1790001251	S.DIO MA2S1110GL [AUS]		
	1790001251	S.DIO MA2S1110GL [CHN]		
D2158	1790001251	S.DIO MA2S1110GL	T	48.6/88.4
D2159	1790001251	S.DIO MA2S1110GL	T	48.6/89.7
D2160	1790001251	S.DIO MA2S1110GL	T	48.6/91.0
D2162	1790001251	S.DIO MA2S1110GL [USA] only	T	46.1/88.4
D2163	1790001251	S.DIO MA2S1110GL [EUR]	T	46.1/89.7
	1790001251	S.DIO MA2S1110GL [FRA]		
	1790001251	S.DIO MA2S1110GL [ESP]		
	1790001251	S.DIO MA2S1110GL [ITR]		
	1790001251	S.DIO MA2S1110GL [UK]		
D2166	1790001251	S.DIO MA2S1110GL [ESP]	T	29.4/88.3
	1790001251	S.DIO MA2S1110GL [KOR]		
D2168	1790001251	S.DIO MA2S1110GL [EUR]	T	29.4/90.7
	1790001251	S.DIO MA2S1110GL [ESP]		
	1790001251	S.DIO MA2S1110GL [ITR]		
	1790001251	S.DIO MA2S1110GL [UK]		
	1790001251	S.DIO MA2S1110GL [AUS]		
D2169	1790001251	S.DIO MA2S1110GL [EUR]	T	26.9/87.1
	1790001251	S.DIO MA2S1110GL [ESP]		
	1790001251	S.DIO MA2S1110GL [USA]		
	1790001251	S.DIO MA2S1110GL [EXP]		
	1790001251	S.DIO MA2S1110GL [ITR]		
	1790001251	S.DIO MA2S1110GL [UK]		
	1790001251	S.DIO MA2S1110GL [KOR]		
	1790001251	S.DIO MA2S1110GL [CHN]		
D2170	1790001251	S.DIO MA2S1110GL [EUR]	T	26.9/88.4
	1790001251	S.DIO MA2S1110GL [USA]		
	1790001251	S.DIO MA2S1110GL [EXP]		
	1790001251	S.DIO MA2S1110GL [ITR]		
	1790001251	S.DIO MA2S1110GL [UK]		
	1790001251	S.DIO MA2S1110GL [AUS]		
	1790001251	S.DIO MA2S1110GL [CHN]		
D2171	1790001251	S.DIO MA2S1110GL [FRA]	T	26.9/89.7
	1790001251	S.DIO MA2S1110GL [ESP]		
	1790001251	S.DIO MA2S1110GL [EXP]		
	1790001251	S.DIO MA2S1110GL [UK]		
	1790001251	S.DIO MA2S1110GL [KOR]		
D2172	1790001251	S.DIO MA2S1110GL [CHN]	T	26.9/91.0
	1790001251	S.DIO MA2S1110GL [EUR]		
	1790001251	S.DIO MA2S1110GL [FRA]		
	1790001251	S.DIO MA2S1110GL [ESP]		
	1790001251	S.DIO MA2S1110GL [ITR]		
	1790001251	S.DIO MA2S1110GL [UK]		
	1790001251	S.DIO MA2S1110GL [KOR]		
	1790001251	S.DIO MA2S1110GL [AUS]		
	1790001251	S.DIO MA2S1110GL [CHN]		
D2173	1790001251	S.DIO MA2S1110GL	T	6.5/120.2
D2174	1790001251	S.DIO MAZ8043GLL [EUR]	T	52.1/88.3
	1790001251	S.DIO MA2S1110GL [FRA]		
	1790001251	S.DIO MA2S1110GL [ESP]		
	1790001251	S.DIO MA2S1110GL [USA]		
	1790001251	S.DIO MA2S1110GL [EXP]		
	1790001251	S.DIO MA2S1110GL [UK]		
	1790001251	S.DIO MA2S1110GL [KOR]		
	1790001251	S.DIO MA2S1110GL [AUS]		
	1790001251	S.DIO MA2S1110GL [CHN]		
D2175	1790001251	S.DIO MA2S1110GL	T	52.1/87.1
D2201	1730002341	S.ZEN MAZ8047GML	T	10.5/122.8
D2205	1790001011	S.ZEN MAZ8043GLL	T	13.5/115.2
D2211	1790001011	S.ZEN MAZ8043GLL	T	21.5/118.0
D2231	1160000070	S.DIO DAN202K T146	T	57.7/117.9
D2232	1790001670	S.DIO RB706F-40T106	T	56.9/112.2
D2401	1160000070	S.DIO DAN202K T146	B	85.8/27.2
D2402	1790001251	S.DIO MA2S1110GL	T	63.6/113.3

[MAIN UNIT]

REF NO.	PARTS NO.	DESCRIPTION	M.	H/V LOCATION
D2551	1790001141	S.ZEN MAZ8039GLL	B	45.4/116.5
D2601	1160000070	S.DIO DAN202K T146	B	41.1/126.4
D2602	1790001251	S.DIO MA2S1110GL	B	42.1/128.5
FI2	2040001420	S.LC LFB32440MSC1-955 (LFSC25N12B0)	T	59.4/13.9
FI3	2040001420	S.LC LFB32440MSC1-955 (LFSC25N12B0)	T	53.4/13.5
FI601	2010002640	S.XTA DSF753SDF 124.487 MHz (FL-374)	T	81.0/43.8
FI901	2020002011	S.CER CFUKG455KF4A-R0	T	44.8/69.7
FI1001	2020002011	S.CER CFUKG455KF4A-R0	T	27.8/67.0
FI1401	2020001810	S.CER SFECV10M7FA00-R0 (SFECV10.7MA5S)	B	37.5/76.5
FI1402	2020001810	S.CER SFECV10M7FA00-R0 (SFECV10.7MA5S)	B	29.5/77.5
FI1501	2040002050	SAW K3561M [EUR]		
	2040002050	SAW K3561M [FRA]		
	2040002050	SAW K3561M [ESP]		
	2040002040	SAW M3565M [USA]		
	2040002050	SAW K3561M [EXP]		
	2040002050	SAW K3561M [ITR]		
	2040002050	SAW K3561M [UK]		
	2040002040	SAW M3565M [KOR]		
	2040002050	SAW K3561M [AUS]		
	2040002050	SAW K3561M [CHN]		
FI1502	2020001720	S.CER SFSKA5M50CF00-R1 (SFSCC5.5MC2-T) [EUR]	B	69.4/57.8
	2020001720	S.CER SFSKA5M50CF00-R1 (SFSCC5.5MC2-T) [FRA]		
	2020001720	S.CER SFSKA5M50CF00-R1 (SFSCC5.5MC2-T) [ESP]		
	2020001700	S.CER SFSKA4M50CF00-R1 (SFSCC4.5MC2-T) [USA]		
	2020001720	S.CER SFSKA5M50CF00-R1 (SFSCC5.5MC2-T) [EXP]		
	2020001720	S.CER SFSKA5M50CF00-R1 (SFSCC5.5MC2-T) [ITR]		
	2020001720	S.CER SFSKA5M50CF00-R1 (SFSCC5.5MC2-T) [UK]		
	2020001700	S.CER SFSKA4M50CF00-R1 (SFSCC4.5MC2-T) [KOR]		
	2020001720	S.CER SFSKA5M50CF00-R1 (SFSCC5.5MC2-T) [AUS]		
	2020001720	S.CER SFSKA5M50CF00-R1 (SFSCC5.5MC2-T) [CHN]		
FI1503	2020001730	S.CER TPSKA5M50B00-R1 (TPSCC5.5MB-TC1) [EUR]	B	73.6/78.7
	2020001730	S.CER TPSKA5M50B00-R1 (TPSCC5.5MB-TC1) [FRA]		
	2020001730	S.CER TPSKA5M50B00-R1 (TPSCC5.5MB-TC1) [ESP]		
	2020001710	S.CER TPSKA4M50B00-R1 (TPSCC4.5MB-TC1) [USA]		
	2020001730	S.CER TPSKA5M50B00-R1 (TPSCC5.5MB-TC1) [EXP]		
	2020001730	S.CER TPSKA5M50B00-R1 (TPSCC5.5MB-TC1) [ITR]		
	2020001730	S.CER TPSKA5M50B00-R1 (TPSCC5.5MB-TC1) [UK]		
	2020001710	S.CER TPSKA4M50B00-R1 (TPSCC4.5MB-TC1) [KOR]		
	2020001730	S.CER TPSKA5M50B00-R1 (TPSCC5.5MB-TC1) [AUS]		
	2020001730	S.CER TPSKA5M50B00-R1 (TPSCC5.5MB-TC1) [CHN]		
L3	6200004480	S.COI MLF1608D R82K-T	T	76.5/10.2
L4	6200002041	S.COI NLV25T-101J	T	75.7/18.9
L5	6200004780	S.COI MLF1608A 1R5K-T	T	67.4/18.6
L8	6200010910	S.COI LQW18AN56NG00D	T	57.0/16.7
L10	6200010910	S.COI LQW18AN56NG00D	T	57.3/19.0
L11	6200011780	S.COI LQW18ANR18G00D	T	56.5/20.1
L12	6200011680	S.COI LQW18ANR12G00D	T	53.8/19.9
L13	6200011780	S.COI LQW18ANR18G00D	T	52.8/18.6
L14	6200009590	S.COI MLG1608B 18NJ-T	T	57.3/11.4
L16	6200005721	S.COI ELJRE 33NGFA	T	49.6/19.8
L18	6200005041	S.COI NLV25T-220J	T	73.4/9.6
L19	6200002041	S.COI NLV25T-101J	T	67.0/14.8
L21	6200006671	S.COI ELJRE 68NGFA	B	80.4/14.7
L22	6200002861	S.COI NLV25T-4R7J	B	79.8/20.3
L23	6200002861	S.COI NLV25T-4R7J	B	84.0/9.3
L24	6200011520	S.COI SLF7045T-102MR14-PF	B	8.9/69.0
L101	6200002041	S.COI NLV25T-101J	T	15.8/17.1
L102	6200002041	S.COI NLV25T-101J	T	20.4/10.9
L103	6200010800	S.COI C2520C-4R7G-A	T	24.4/7.4
L104	6200010800	S.COI C2520C-4R7G-A	T	27.9/10.0
L105	6200002041	S.COI NLV25T-101J	T	28.1/12.9
L106	6200002041	S.COI NLV25T-101J	B	17.6/16.4
L107	6200002041	S.COI NLV25T-101J	B	31.6/21.7
L108	6200002041	S.COI NLV25T-101J	T	25.3/20.9
L109	6200001831	S.COI NLV32T-100J	T	28.5/15.6
L110	6200003121	S.COI NLV32T-8R2J	T	21.1/15.1
L112	6200002041	S.COI NLV25T-101J	B	43.5/23.1
L113	6200002041	S.COI NLV25T-101J	T	7.2/17.6
L114	6200002041	S.COI NLV25T-101J	T	7.2/15.0

M.=Mounted side (T: Mounted on the Top side, B: Mounted on the Bottom side)
S.=Surface mount

[MAIN UNIT]

REF NO.	PARTS NO.	DESCRIPTION	M.	H/V LOCATION
L116	6200003131	S.COI NLV32T-120J	T	28.5/18.6
L117	6200001831	S.COI NLV32T-100J	T	21.1/18.1
L204	6200002041	S.COI NLV25T-101J	T	18.8/33.0
L205	6200010740	S.COI C2520C-R27G-A	T	20.3/38.2
L207	6200010680	S.COI C2520C-R22G-A (0.22U)	T	21.8/41.3
L213	6200005011	S.COI NLV25T-100J	T	22.7/34.9
L215	6200010330	S.COI C2012C-R18G-A	B	27.8/38.6
L217	6200009990	S.COI C2012C-R22G-A	T	22.7/32.5
L218	6200005011	S.COI NLV25T-100J	B	25.7/43.4
L219	6200011050	S.COI C2012C-R12G-A	B	29.0/41.4
L220	6200010320	S.COI C2012C-R15G-A	B	34.1/37.9
L221	6200002041	S.COI NLV25T-101J	T	15.1/52.7
L222	6200002041	S.COI NLV25T-101J	T	45.6/61.5
L223	6200002041	S.COI NLV25T-101J	B	40.5/55.3
L224	6200002041	S.COI NLV25T-101J	B	27.5/55.8
L225	6200002041	S.COI NLV25T-101J	B	27.5/52.0
L226	6200002861	S.COI NLV25T-4R7J	T	40.3/57.6
L227	6200003711	S.COI NLV25T-2R7J	T	29.1/55.5
L228	6200002861	S.COI NLV25T-4R7J	T	44.6/54.7
L229	6200004671	S.COI NLV25T-3R9J	T	35.1/51.5
L230	6200002041	S.COI NLV25T-101J	B	40.5/52.3
L231	6200002041	S.COI NLV25T-101J	B	40.5/49.5
L232	6200002041	S.COI NLV25T-101J	B	27.1/49.1
L233	6200002041	S.COI NLV25T-101J	B	26.4/46.2
L234	6200010780	S.COI C2520C-1R0G-A	T	35.6/48.5
L235	6200010530	S.COI C2520C-R56G-A (0.56U)	B	33.0/49.5
L236	6200010950	S.COI C2520C-1R5G-A (1.5U)	T	43.4/50.4
L237	6200010450	S.COI C2520C-R82G-A (0.82U)	B	33.0/46.4
L238	6200002041	S.COI NLV25T-101J	B	44.0/45.1
L239	6200002041	S.COI NLV25T-101J	B	38.8/39.5
L240	6200002041	S.COI NLV25T-101J	T	29.5/42.1
L241	6200010870	S.COI C2520C-R33G-A (0.33U)	B	35.2/41.6
L242	6200005011	S.COI NLV25T-100J	T	33.5/29.9
L243	6140004601	S.COI LR-518A	T	28.4/35.2
L244	6200010960	S.COI C2520C-R47G-A (0.47U)	B	39.8/44.2
L245	6200005011	S.COI NLV25T-100J	B	41.3/28.3
L246	6200009990	S.COI C2012C-R22G-A	B	30.7/36.4
L247	6200010320	S.COI C2012C-R15G-A	B	42.2/38.7
L248	6200005011	S.COI NLV25T-100J	B	43.8/36.4
L301	6200002041	S.COI NLV25T-101J	T	36.1/27.4
L302	6200002041	S.COI NLV25T-101J	T	52.6/31.8
L303	6200002041	S.COI NLV25T-101J	T	52.3/35.4
L304	6140004591	S.COI LR-517A	T	56.4/39.0
L305	6200002041	S.COI NLV25T-101J	T	52.9/29.3
L306	6200002041	S.COI NLV25T-101J	T	61.8/39.4
L307	6200002041	S.COI NLV25T-101J	T	60.9/32.0
L308	6200002041	S.COI NLV25T-101J	T	65.0/33.1
L309	6200009070	S.COI LQW18AN18NG00D (LQW1608A18NG00)	T	49.3/24.0
L310	6200010650	S.COI C2520C-R12G-A (0.12U)	T	65.7/38.2
L311	6200009220	S.COI LQW18AN15NG00D (LQW1608A15NG00)	T	53.6/23.3
L312	6200010660	S.COI C2520C-R15G-A (0.15U)	T	69.6/34.3
L313	6200011730	S.COI LQW18AN10NG00D	T	61.6/25.7
L314	6200002041	S.COI NLV25T-101J	T	72.6/37.4
L315	6200002041	S.COI NLV25T-101J	T	75.9/31.9
L402	6140004610	S.COI LR-520	T	70.8/27.9
L403	6200002041	S.COI NLV25T-101J	T	81.1/19.8
L404	6130002961	S.COI #617DB-1327=P3	T	84.4/27.9
L406	6130002961	S.COI #617DB-1327=P3	T	77.7/24.2
L421	6200004590	S.COI MLF1608D R18K-T	T	86.4/21.7
L501	6200004660	S.COI MLF1608A 1R8K-T	T	93.4/35.8
L503	6200004660	S.COI MLF1608A 1R8K-T	T	83.3/31.2
L507	6200001981	S.COI NLV25T-1R0J	T	78.8/34.4
L508	6200010650	S.COI C2520C-R12G-A (0.12U)	T	86.4/34.4
L509	6200004660	S.COI MLF1608A 1R8K-T	T	93.2/38.8
L511	6200004150	S.COI MLF1608D 47NM-T	T	92.7/37.3
L512	6200009610	S.COI MLG1608B 39NJ-T	B	89.7/32.9
L601	6200004660	S.COI MLF1608A 1R8K-T	B	85.7/38.6
L603	6200004660	S.COI MLF1608A 1R8K-T	T	89.4/42.2
L604	6150005330	S.COI LS-548 PKI-4185	T	90.5/46.2
L605	6200004660	S.COI MLF1608A 1R8K-T	T	93.2/40.0
L607	6200011800	S.COI C2520C-47NG-A	B	85.5/43.6
L609	6200011800	S.COI C2520C-47NG-A	B	81.9/46.9
L610	6200004660	S.COI MLF1608A 1R8K-T	B	78.2/44.9
L611	6200004660	S.COI MLF1608A 1R8K-T	T	68.0/46.3
L612	6150005330	S.COI LS-548 PKI-4185	T	72.3/42.4
L701	6150005350	S.COI LS-550 PKI-4187	T	62.9/48.6
L702	6150005340	S.COI LS-549 PKI-4187	T	54.8/45.5
L703	6150005350	S.COI LS-550 PKI-4187	T	55.3/59.9
L704	6200004940	S.COI MLF1608D R27K-T	T	62.3/59.7
L705	6200009920	S.COI C2012C-R10G-A	T	61.8/41.7
L801	6140002810	S.COI LR-317	T	68.6/61.3
L802	6200005190	S.COI MLF1608D R56K-T	T	89.1/58.5
L803	6140002810	S.COI LR-317	T	79.6/60.2
L804	6200005011	S.COI NLV25T-100J	T	57.5/69.1
L805	6200009871	S.COI NLV25T-120J	T	57.6/71.9
L806	6200004741	S.COI NLV25T-1R2J	T	63.1/71.2
L807	6200004741	S.COI NLV25T-1R2J	T	63.2/66.7
L808	6200004100	S.COI MLF1608D 68NM-T	T	86.2/61.7
L901	6200003520	S.COI ELJFB 102K-F	B	37.6/72.5
L904	6150005360	S.COI LS-551 PKI-4188-1	T	51.7/70.9
L905	6200003520	S.COI ELJFB 102K-F	B	40.2/59.9
L906	6200003520	S.COI ELJFB 102K-F	B	33.7/62.5
L908	6200003520	S.COI ELJFB 102K-F	B	31.5/69.8
L1003	6200003520	S.COI ELJFB 102K-F	B	13.0/75.3
L1102	6200002041	S.COI NLV25T-101J	T	7.1/89.7
L1301	6200002041	S.COI NLV25T-101J	T	8.3/55.8

[MAIN UNIT]

REF NO.	PARTS NO.	DESCRIPTION	M.	H/V LOCATION
L1302	6200002041	S.COI NLV25T-101J	T	11.8/58.6
L1303	6200002041	S.COI NLV25T-101J	T	4.8/55.8
L1401	6200002041	S.COI NLV25T-101J	B	43.4/79.7
L1402	6200004790	S.COI MLF1608D R47K-T	B	44.1/70.4
L1403	6200002041	S.COI NLV25T-101J	B	43.0/77.1
L1404	6200003711	S.COI NLV25T-2R7J	B	18.3/80.4
L1405	6200002041	S.COI NLV25T-101J	B	17.7/85.0
L1491	6200010870	S.COI C2520C-R33G-A (0.33U) [EUR]	B	85.0/30.7
	6200010870	S.COI C2520C-R33G-A (0.33U) [FRA]		
	6200010870	S.COI C2520C-R33G-A (0.33U) [ESP]		
	6200010740	S.COI C2520C-R27G-A [USA]		
	6200010870	S.COI C2520C-R33G-A (0.33U) [EXP]		
	6200010870	S.COI C2520C-R33G-A (0.33U) [ITR]		
	6200010870	S.COI C2520C-R33G-A (0.33U) [UK]		
	6200010740	S.COI C2520C-R27G-A [KOR]		
	6200010870	S.COI C2520C-R33G-A (0.33U) [AUS]		
	6200010870	S.COI C2520C-R33G-A (0.33U) [CHN]		
L1492	6200010870	S.COI C2520C-R33G-A (0.33U) [EUR]	B	80.6/33.1
	6200010870	S.COI C2520C-R33G-A (0.33U) [FRA]		
	6200010870	S.COI C2520C-R33G-A (0.33U) [ESP]		
	6200010740	S.COI C2520C-R27G-A [USA]		
	6200010870	S.COI C2520C-R33G-A (0.33U) [EXP]		
	6200010870	S.COI C2520C-R33G-A (0.33U) [ITR]		
	6200010870	S.COI C2520C-R33G-A (0.33U) [UK]		
	6200010740	S.COI C2520C-R27G-A [KOR]		
	6200010870	S.COI C2520C-R33G-A (0.33U) [AUS]		
	6200010870	S.COI C2520C-R33G-A (0.33U) [CHN]		
L1501	6200005011	S.COI NLV25T-100J	B	91.2/27.1
L1502	6200012170	S.COI MLG1608S R18J-T	B	79.5/38.3
L1503	6200012170	S.COI MLG1608S R18J-T	B	82.1/37.5
L1504	6200005011	S.COI NLV25T-100J	B	75.7/43.4
L1505	6200005190	S.COI MLF1608D R56K-T	B	80.7/51.7
L1506	6150005080	S.COI LS-535 (4KMH) [EUR]	T	68.7/55.4
	6150005080	S.COI LS-535 (4KMH) [FRA]		
	6150005080	S.COI LS-535 (4KMH) [ESP]		
	6150005070	S.COI LS-534 (4KMH) [USA]		
	6150005080	S.COI LS-535 (4KMH) [EXP]		
	6150005080	S.COI LS-535 (4KMH) [ITR]		
	6150005080	S.COI LS-535 (4KMH) [UK]		
	6150005070	S.COI LS-534 (4KMH) [KOR]		
	6150005080	S.COI LS-535 (4KMH) [AUS]		
	6150005080	S.COI LS-535 (4KMH) [CHN]		
L1507	6200005031	S.COI NLV25T-180J	B	71.7/62.2
L1508	6200005021	S.COI NLV25T-150J	B	77.7/79.6
L1951	6180003750	S.COI 7E10Y-101M-R-0231	B	34.6/110.9
L1952	6180003750	S.COI 7E10Y-101M-R-0231	B	54.7/113.4
L1953	6180003750	S.COI 7E10Y-101M-R-0231	B	14.0/111.9
L1954	6180003750	S.COI 7E10Y-101M-R-0231	B	24.5/119.8
L2001	6200005011	S.COI NLV25T-100J	B	72.5/16.4
L2002	6200002041	S.COI NLV25T-101J	B	84.6/3.8
L2003	6200002041	S.COI NLV25T-101J	B	81.1/4.3
L2004	6200002041	S.COI NLV25T-101J	B	76.4/20.4
L2006	6200002041	S.COI NLV25T-101J	B	64.2/12.9
L2007	6200002041	S.COI NLV25T-101J	B	70.9/3.9
L2008	6200002041	S.COI NLV25T-101J	B	68.0/6.2
L2009	6200005011	S.COI NLV25T-100J	B	70.9/10.6
L2010	6200002041	S.COI NLV25T-101J	B	60.8/13.7
L2011	6200011300	S.COI EXCML16A270U	T	86.6/9.2
L2012	6200011300	S.COI EXCML16A270U	B	84.8/22.0
L2013	6200002041	S.COI NLV25T-101J	B	71.9/19.4
L2015	6200002041	S.COI NLV25T-101J	B	52.5/10.4
L2016	6200002041	S.COI NLV25T-101J	B	59.2/11.2
L2017	6200002041	S.COI NLV25T-101J	B	57.1/14.1
L2018	6200002041	S.COI NLV25T-101J	B	19.7/129.5
L2019	6200002041	S.COI NLV25T-101J	T	22.3/126.9
L2020	6200002041	S.COI NLV25T-101J	B	28.0/131.4
L2021	6200005011	S.COI NLV25T-100J	B	27.9/126.5
L2022	6200002041	S.COI NLV25T-101J	B	26.2/127.6
L2023	6200002041	S.COI NLV25T-101J	B	23.3/131.4
L2024	6200002041	S.COI NLV25T-101J	T	12.8/128.2
L2025	6200002041	S.COI NLV25T-101J	B	87.5/6.3
L2026	6200002041	S.COI NLV25T-101J	B	77.7/5.0
L2027	6200002041	S.COI NLV25T-101J	B	76.6/12.3
L2028	6200002041	S.COI NLV25T-101J	B	67.5/10.8
L2029	6200002041	S.COI NLV25T-101J	B	64.1/10.4
L2030	6200002041	S.COI NLV25T-101J	B	67.5/3.7
L2031	6200002041	S.COI NLV25T-101J	B	76.5/14.8
L2032	6200002041	S.COI NLV25T-101J	B	66.2/15.4
L2033	6200011300	S.COI EXCML16A270U	B	69.6/14.6
L2034	6200009300	S.COI ELJPA 100KF 10U	B	67.9/19.4
L2035	6200002041	S.COI NLV25T-101J	B	59.8/18.5
L2036	6200002041	S.COI NLV25T-101J	B	64.1/3.8
L2037	6200002041	S.COI NLV25T-101J	B	88.4/3.8
L2041	6180003750	S.COI 7E10Y-101M-R-0231	B	62.6/86.9
L2042	6200002861	S.COI NLV25T-4R7J	B	62.9/79.3
L2053	6200002041	S.COI NLV25T-101J	B	28.7/91.0
L2151	6200002041	S.COI NLV25T-101J	B	36.9/121.1
L2152	6200002041	S.COI NLV25T-101J	B	52.3/14.7
L2201	6200005011	S.COI NLV25T-100J	T	27.4/125.9
L2202	6200005011	S.COI NLV25T-100J	T	17.1/124.3
L2231	6200002041	S.COI NLV25T-101J	T	34.0/104.3
L2256	6200002041	S.COI NLV25T-101J	T	15.0/1

[MAIN UNIT]

REF NO.	PARTS NO.	DESCRIPTION	M.	H/V LOCATION
L2267	6200002041	S.COI NLV25T-101J	T	66.1/89.7
L2268	6200002041	S.COI NLV25T-101J	T	62.5/87.2
L2272	6200002041	S.COI NLV25T-101J	T	71.1/90.2
L2402	6200002041	S.COI NLV25T-101J	B	89.4/98.0
L2403	6200002041	S.COI NLV25T-101J	B	89.2/84.0
L2404	6200002041	S.COI NLV25T-101J	T	81.6/96.8
L2405	6200002041	S.COI NLV25T-101J	B	89.3/95.5
L2406	6200002041	S.COI NLV25T-101J	T	84.8/93.8
L2408	6200011300	S.COI EXCML16A270U	T	82.2/92.3
L2409	6200002041	S.COI NLV25T-101J	B	89.3/88.5
L2411	6200011300	S.COI EXCML16A270U	T	85.1/89.7
L2601	6200009330	S.COI SLF12555T-681MR43-PF	T	87.6/119.7
L2605	6200009330	S.COI SLF12555T-681MR43-PF	T	71.1/119.7
R1	7030011400	S.RES ERJ2GEJ 5R6 X (5.6)	T	79.7/17.0
R2	7030009270	S.RES ERJ2GEJ 821 X (820)	T	81.3/17.0
R3	7030009270	S.RES ERJ2GEJ 821 X (820)	T	79.7/17.0
R5	7030010090	S.RES ERJ2GEJ 180 X (18)	T	74.2/16.7
R6	7030008280	S.RES ERJ2GEJ 271 X (270)	T	74.8/15.8
R7	7030008280	S.RES ERJ2GEJ 271 X (270)	T	73.2/15.8
R8	7030009200	S.RES ERJ2GEJ 390 X (39)	T	73.1/18.5
R9	7030003400	S.RES ERJ3GEYJ 471 V (470)	T	69.9/13.3
R10	7030005120	S.RES ERJ2GEJ 102 X (1K)	T	72.8/14.2
R11	7030005300	S.RES ERJ2GEJ 150 X (15)	T	62.1/16.0
R12	7030010040	S.RES ERJ2GEJ-JPW	T	62.9/13.9
R13	7030005090	S.RES ERJ2GEJ 104 X (100K)	T	66.8/20.6
R15	7030005090	S.RES ERJ2GEJ 104 X (100K)	T	70.4/10.5
R16	7030003860	S.RES ERJ3GE JPW V	T	62.5/12.4
R17	7030005090	S.RES ERJ2GEJ 104 X (100K)	T	76.4/15.8
R18	7030007270	S.RES ERJ2GEJ 151 X (150)	T	44.3/17.3
R19	7030003860	S.RES ERJ3GE JPW V	T	50.4/14.6
R20	7030009530	S.RES ERJ2GEJ 270 X (27)	T	69.5/19.8
R21	7030009530	S.RES ERJ2GEJ 270 X (27)	T	65.5/22.8
R22	7030010040	S.RES ERJ2GEJ-JPW	T	78.1/13.8
R23	7030007290	S.RES ERJ2GEJ 222 X (2.2K)	T	79.8/13.8
R24	7030005010	S.RES ERJ2GEJ 681 X (680)	T	78.1/12.9
R25	7030005120	S.RES ERJ2GEJ 102 X (1K)	B	79.3/18.5
R27	7030005120	S.RES ERJ2GEJ 102 X (1K)	B	81.4/8.6
R29	7030004980	S.RES ERJ2GEJ 101 X (100)	T	73.1/11.3
R30	7030009160	S.RES ERJ2GEJ 181 X (180)	T	46.5/15.4
R31	7030007270	S.RES ERJ2GEJ 151 X (150)	T	42.7/17.3
R32	7030009200	S.RES ERJ2GEJ 390 X (39)	T	44.2/18.2
R35	7030003860	S.RES ERJ3GE JPW V	[EUR] T	59.9/17.9
	7030003860	S.RES ERJ3GE JPW V	[FRA]	
	7030003860	S.RES ERJ3GE JPW V	[ESP]	
	7030003860	S.RES ERJ3GE JPW V	[USA]	
	7030003860	S.RES ERJ3GE JPW V	[EXP]	
	7030003860	S.RES ERJ3GE JPW V	[ITR]	
	7030003860	S.RES ERJ3GE JPW V	[UK]	
	7030003860	S.RES ERJ3GE JPW V	[KOR]	
	7030003860	S.RES ERJ3GE JPW V	[CHN]	
R101	7030005050	S.RES ERJ2GEJ 103 X (10K)	T	13.2/16.0
R102	7030005120	S.RES ERJ2GEJ 102 X (1K)	T	11.9/14.6
R103	7030005050	S.RES ERJ2GEJ 103 X (10K)	T	10.3/14.6
R104	7030005090	S.RES ERJ2GEJ 104 X (100K)	T	15.7/13.5
R105	7030005580	S.RES ERJ2GEJ 560 X (56)	T	15.8/22.4
R106	7030005000	S.RES ERJ2GEJ 471 X (470)	T	13.2/20.5
R107	7030005000	S.RES ERJ2GEJ 471 X (470)	T	10.9/22.1
R108	7030005000	S.RES ERJ2GEJ 471 X (470)	T	10.9/23.0
R111	7030005000	S.RES ERJ2GEJ 471 X (470)	T	10.9/21.2
R112	7030005090	S.RES ERJ2GEJ 104 X (100K)	T	25.6/12.6
R113	7030005090	S.RES ERJ2GEJ 104 X (100K)	T	26.9/5.7
R114	7030009280	S.RES ERJ2GEJ 391 X	B	33.2/23.4
R115	7030009280	S.RES ERJ2GEJ 391 X	B	34.1/22.3
R116	7030009280	S.RES ERJ2GEJ 391 X	T	22.3/21.3
R117	7030009280	S.RES ERJ2GEJ 391 X	T	20.7/21.3
R118	7030009280	S.RES ERJ2GEJ 391 X	B	41.0/23.3
R119	7030009280	S.RES ERJ2GEJ 391 X	B	41.0/22.4
R120	7030005090	S.RES ERJ2GEJ 104 X (100K)	B	50.4/23.6
R121	7030005090	S.RES ERJ2GEJ 104 X (100K)	T	44.1/22.3
R122	7030009280	S.RES ERJ2GEJ 391 X	T	7.8/20.3
R123	7030009280	S.RES ERJ2GEJ 391 X	T	7.8/19.4
R125	7030009280	S.RES ERJ2GEJ 391 X	T	35.6/20.3
R126	7030009280	S.RES ERJ2GEJ 391 X	T	27.1/4.8
R127	7030009280	S.RES ERJ2GEJ 391 X	T	25.5/4.8
R128	7030009280	S.RES ERJ2GEJ 391 X	T	35.6/19.4
R202	7030005090	S.RES ERJ2GEJ 104 X (100K)	T	18.1/31.2
R203	7030005090	S.RES ERJ2GEJ 104 X (100K)	T	42.9/60.0
R204	7030005090	S.RES ERJ2GEJ 104 X (100K)	B	43.0/54.4
R205	7030009280	S.RES ERJ2GEJ 391 X	T	19.4/54.2
R206	7030005090	S.RES ERJ2GEJ 104 X (100K)	B	43.0/51.5
R207	7030005090	S.RES ERJ2GEJ 104 X (100K)	B	43.0/50.6
R208	7030005090	S.RES ERJ2GEJ 104 X (100K)	B	46.5/45.1
R216	7030005090	S.RES ERJ2GEJ 104 X (100K)	B	44.3/43.3
R217	7030005050	S.RES ERJ2GEJ 103 X (10K)	T	18.1/30.3
R218	7030004970	S.RES ERJ2GEJ 470 X (47)	T	21.9/30.0
R225	7030005050	S.RES ERJ2GEJ 103 X (10K)	T	19.1/29.1
R226	7030009280	S.RES ERJ2GEJ 391 X	T	17.6/54.2
R227	7030005120	S.RES ERJ2GEJ 102 X (1K)	T	30.9/31.0
R228	7030009140	S.RES ERJ2GEJ 272 X (2.7K)	T	30.9/29.2
R301	7030009280	S.RES ERJ2GEJ 391 X	T	44.5/28.8
R302	7030009280	S.RES ERJ2GEJ 391 X	T	38.6/27.9
R303	7030004970	S.RES ERJ2GEJ 470 X (47)	T	52.5/38.9
R304	7030004980	S.RES ERJ2GEJ 101 X (100)	T	55.1/35.6
R305	7030005120	S.RES ERJ2GEJ 102 X (1K)	T	60.0/33.8
R306	7030008280	S.RES ERJ2GEJ 271 X (270)	T	55.4/28.8
R307	7030004980	S.RES ERJ2GEJ 101 X (100)	T	56.8/35.6

[MAIN UNIT]

REF NO.	PARTS NO.	DESCRIPTION	M.	H/V LOCATION
R308	7030007290	S.RES ERJ2GEJ 222 X (2.2K)	T	59.2/30.1
R309	7030008280	S.RES ERJ2GEJ 271 X (270)	T	58.6/29.2
R310	7030005090	S.RES ERJ2GEJ 104 X (100K)	T	50.1/31.7
R311	7030009280	S.RES ERJ2GEJ 391 X	T	65.4/31.4
R312	7030009280	S.RES ERJ2GEJ 391 X	T	63.8/31.4
R314	7030009280	S.RES ERJ2GEJ 391 X	T	73.4/32.5
R315	7030009280	S.RES ERJ2GEJ 391 X	T	74.9/33.8
R401	7030010040	S.RES ERJ2GEJ-JPW	T	75.0/29.6
R402	7030010040	S.RES ERJ2GEJ-JPW	T	75.0/27.8
R403	7030004980	S.RES ERJ2GEJ 101 X (100)	T	76.7/29.7
R404	7030010040	S.RES ERJ2GEJ-JPW	T	72.0/23.2
R405	7030004980	S.RES ERJ2GEJ 101 X (100)	T	86.8/23.9
R406	7030005580	S.RES ERJ2GEJ 560 X (56)	T	73.1/30.6
R407	7030005580	S.RES ERJ2GEJ 560 X (56)	T	72.0/25.0
R408	7030010040	S.RES ERJ2GEJ-JPW	T	83.4/19.3
R411	7030007260	S.RES ERJ2GEJ 330 X (33)	T	80.1/29.5
R412	7030007260	S.RES ERJ2GEJ 330 X (33)	T	80.1/26.8
R414	7030004980	S.RES ERJ2GEJ 101 X (100)	T	78.3/29.7
R416	7030010090	S.RES ERJ2GEJ 180 X (18)	T	88.4/24.5
R417	7030008280	S.RES ERJ2GEJ 271 X (270)	T	89.3/25.3
R418	7030008280	S.RES ERJ2GEJ 271 X (270)	T	88.0/22.9
R421	7030010090	S.RES ERJ2GEJ 180 X (18)	B	88.6/20.2
R422	7030008280	S.RES ERJ2GEJ 271 X (270)	B	90.2/20.2
R423	7030008280	S.RES ERJ2GEJ 271 X (270)	B	92.2/19.3
R424	7030005530	S.RES ERJ2GEJ 100 X (10)	T	88.5/21.6
R501	7030005120	S.RES ERJ2GEJ 102 X (1K)	T	91.3/35.6
R502	7030005120	S.RES ERJ2GEJ 102 X (1K)	T	92.9/34.4
R509	7030005580	S.RES ERJ2GEJ 560 X (56)	T	83.5/33.1
R510	7030010040	S.RES ERJ2GEJ-JPW	T	83.5/34.1
R512	7030004980	S.RES ERJ2GEJ 101 X (100)	T	81.8/34.1
R517	7030010040	S.RES ERJ2GEJ-JPW	B	80.0/31.0
R518	7030007290	S.RES ERJ2GEJ 222 X (2.2K)	T	79.6/37.1
R519	7030007290	S.RES ERJ2GEJ 222 X (2.2K)	T	79.6/38.9
R520	7030005120	S.RES ERJ2GEJ 102 X (1K)	T	89.2/39.2
R521	7030005000	S.RES ERJ2GEJ 471 X (470)	T	84.3/40.4
R523	7030005120	S.RES ERJ2GEJ 102 X (1K)	T	91.3/34.7
R524	7030005120	S.RES ERJ2GEJ 102 X (1K)	B	86.9/37.0
R601	7030005000	S.RES ERJ2GEJ 471 X (470)	B	88.6/40.0
R602	7030005000	S.RES ERJ2GEJ 471 X (470)	T	91.1/39.6
R603	7030005000	S.RES ERJ2GEJ 471 X (470)	T	89.2/41.3
R604	7030005000	S.RES ERJ2GEJ 471 X (470)	B	78.7/45.9
R605	7030010040	S.RES ERJ2GEJ-JPW	T	68.3/45.3
R606	7030005090	S.RES ERJ2GEJ 104 X (100K)	T	67.1/47.4
R607	7030005120	S.RES ERJ2GEJ 102 X (1K)	T	66.7/45.3
R701	7030005220	S.RES ERJ2GEJ 223 X (22K)	T	61.2/53.0
R702	7030005120	S.RES ERJ2GEJ 102 X (1K)	T	64.3/44.0
R703	7030004970	S.RES ERJ2GEJ 470 X (47)	T	50.8/44.1
R705	7030004990	S.RES ERJ2GEJ 221 X (220)	T	59.0/51.6
R706	7030009270	S.RES ERJ2GEJ 821 X (820)	T	64.6/56.0
R707	7030004980	S.RES ERJ2GEJ 101 X (100)	T	59.6/57.0
R708	7030007290	S.RES ERJ2GEJ 222 X (2.2K)	T	63.9/58.6
R709	7030005210	S.RES ERJ2GEJ 822 X (8.2K)	T	59.6/55.2
R710	7030005120	S.RES ERJ2GEJ 102 X (1K)	T	59.6/62.5
R711	7030009140	S.RES ERJ2GEJ 272 X (2.7K)	T	50.6/51.5
R712	7030005120	S.RES ERJ2GEJ 102 X (1K)	T	51.2/50.6
R713	7030005050	S.RES ERJ2GEJ 103 X (10K)	T	57.2/51.6
R715	7030004970	S.RES ERJ2GEJ 470 X (47)	T	52.2/54.2
R716	7030005710	S.RES ERJ2GEJ 121 X (120)	T	51.3/57.5
R717	7030007300	S.RES ERJ2GEJ 332 X (3.3K)	T	52.2/51.5
R718	7510001461	S.THE NTCG16 3NH 471JT	T	63.3/54.0
R801	7030008280	S.RES ERJ2GEJ 271 X (270)	T	86.9/55.2
R802	7030005120	S.RES ERJ2GEJ 102 X (1K)	T	65.3/60.9
R803	7030005120	S.RES ERJ2GEJ 102 X (1K)	T	72.0/65.0
R804	7030005530	S.RES ERJ2GEJ 100 X (10)	T	91.2/57.2
R805	7030010090	S.RES ERJ2GEJ 180 X (18)	T	84.8/54.4
R806	7030008280	S.RES ERJ2GEJ 271 X (270)	T	85.3/55.3
R807	7030005120	S.RES ERJ2GEJ 102 X (1K)	T	62.8/64.6
R808	7030004970	S.RES ERJ2GEJ 470 X (47)	T	62.3/69.4
R809	7030008280	S.RES ERJ2GEJ 271 X (270)	T	82.8/60.6
R810	7030010090	S.RES ERJ2GEJ 180 X (18)	T	84.4/60.6
R811	7030008280	S.RES ERJ2GEJ 271 X (270)	T	82.8/59.7
R904	7030003860	S.RES ERJ3GE JPW V	T	36.5/68.1
R905	7030004980	S.RES ERJ2GEJ 101 X (100)	T	39.3/64.6
R906	7030007290	S.RES ERJ2GEJ 222 X (2.2K)	T	39.3/66.6
R908	7030005000	S.RES ERJ2GEJ 471 X (470)	T	35.7/62.0
R909	7030008410	S.RES ERJ2GEJ 392 X (3.9K)	T	34.3/68.4
R912	7030005210	S.RES ERJ2GEJ 822 X (8.2K)	T	34.3/66.6
R913	7030007300	S.RES ERJ2GEJ 332 X (3.3K)	T	40.6/75.1
R914	7030009290	S.RES ERJ2GEJ 562 X (5.6K)	T	35.6/75.5
R915	7030007290	S.RES ERJ2GEJ 222 X (2.2K)	T	36.6/71.0
R916	7030005050	S.RES ERJ2GEJ 103 X (10K)	T	37.2/75.5
R917	7030004970	S.RES ERJ2GEJ 470 X (47)	T	34.3/69.3
R918	7030007290	S.RES ERJ2GEJ 222 X (2.2K)	B	31.5/72.1
R919	7030004980	S.RES ERJ2GEJ 101 X (100)	T	31.5/72.2
R1009	7030009290	S.RES ERJ2GEJ 562 X (5.6K)	T	25.9/72.9
R1018	7030007290	S.RES ERJ2GEJ 222 X (2.2K)	T	20.3/75.1
R1019	7030005050	S.RES ERJ2GEJ 103 X (10K)	T	20.3/76.9
R1020	7030005000	S.RES ERJ2GEJ 471 X (470)	T	12.7/77.6
R1022	7510001461	S.THE NTCG16 3NH 471JT	T	14.8/76.8
R1023	7030008370	S.RES ERJ2GEJ 561 X (560)	T	15.3/

[MAIN UNIT]

REF NO.	PARTS NO.	DESCRIPTION	M.	H/V LOCATION
R2167	7030005530	S.RES ERJ2GEJ 100 X (10)	T	51.9/94.3
R2168	7030005530	S.RES ERJ2GEJ 100 X (10)	T	51.9/95.2
R2169	7030005120	S.RES ERJ2GEJ 102 X (1K)	T	8.8/118.6
R2170	7030005170	S.RES ERJ2GEJ 474 X (470K)	T	5.0/104.5
R2171	7030005240	S.RES ERJ2GEJ 473 X (47K)	T	9.8/114.3
R2172	7030005240	S.RES ERJ2GEJ 473 X (47K)	T	5.1/112.5
R2174	7030005170	S.RES ERJ2GEJ 474 X (470K)	T	5.0/105.4
R2175	7030005170	S.RES ERJ2GEJ 474 X (470K)	T	5.1/111.5
R2176	7030005170	S.RES ERJ2GEJ 474 X (470K)	T	11.4/114.3
R2177	7030005210	S.RES ERJ2GEJ 822 X (8.2K)	T	3.4/108.1
R2202	7030010040	S.RES ERJ2GEJ-JPW	T	26.5/124.1
R2203	7030005080	S.RES ERJ2GEJ 823 X (82K)	T	25.1/122.4
R2204	7030005050	S.RES ERJ2GEJ 103 X (10K)	T	23.5/122.7
R2205	7030005040	S.RES ERJ2GEJ 472 X (4.7K)	T	18.2/118.3
R2206	7030007270	S.RES ERJ2GEJ 151 X (150)	T	12.6/118.8
R2207	7030005090	S.RES ERJ2GEJ 104 X (100K)	T	23.2/121.5
R2208	7030005090	S.RES ERJ2GEJ 104 X (100K)	T	19.1/119.2
R2209	7030004980	S.RES ERJ2GEJ 101 X (100)	T	21.1/116.6
R2211	7030005230	S.RES ERJ2GEJ 334 X (330K)	T	14.6/123.4
R2212	7030005310	S.RES ERJ2GEJ 124 X (120K)	T	13.0/123.4
R2213	7030008010	S.RES ERJ2GEJ 123 X (12K)	T	12.4/124.3
R2214	7030005050	S.RES ERJ2GEJ 103 X (10K)	T	8.8/117.7
R2215	7030005040	S.RES ERJ2GEJ 472 X (4.7K)	T	11.2/120.6
R2217	7030007280	S.RES ERJ2GEJ 331 X (330)	T	24.9/121.5
R2218	7030007270	S.RES ERJ2GEJ 151 X (150)	T	15.5/127.5
R2219	7030007280	S.RES ERJ2GEJ 331 X (330)	T	17.7/126.1
R2220	7030008280	S.RES ERJ2GEJ 271 X (270)	T	16.1/126.1
R2221	7030005050	S.RES ERJ2GEJ 103 X (10K)	T	9.6/120.6
R2230	7030010900	S.RES ERJ2GEVJ 750 V (75)	T	40.5/105.8
R2231	7030005050	S.RES ERJ2GEJ 103 X (10K)	T	4.5/118.2
R2232	7030005050	S.RES ERJ2GEJ 103 X (10K)	T	54.7/117.5
R2251	7030004990	S.RES ERJ2GEJ 221 X (220)	T	6.2/96.9
R2254	7030004990	S.RES ERJ2GEJ 221 X (220)	B	6.8/100.8
R2255	7030004990	S.RES ERJ2GEJ 221 X (220)	B	6.8/101.7
R2256	7030004990	S.RES ERJ2GEJ 221 X (220)	B	6.8/102.6
R2257	7030004990	S.RES ERJ2GEJ 221 X (220)	B	75.3/109.0
R2258	7030004990	S.RES ERJ2GEJ 221 X (220)	B	71.0/106.6
R2259	7030004990	S.RES ERJ2GEJ 221 X (220)	B	75.3/107.8
R2260	7030004990	S.RES ERJ2GEJ 221 X (220)	B	71.0/105.6
R2261	7030004990	S.RES ERJ2GEJ 221 X (220)	B	75.3/106.6
R2262	7030004990	S.RES ERJ2GEJ 221 X (220)	B	71.5/104.6
R2263	7030004990	S.RES ERJ2GEJ 221 X (220)	B	75.6/104.5
R2264	7030004990	S.RES ERJ2GEJ 221 X (220)	B	72.3/103.6
R2267	7030004990	S.RES ERJ2GEJ 221 X (220)	T	78.6/104.2
R2268	7030004990	S.RES ERJ2GEJ 221 X (220)	T	78.6/103.3
R2269	7030004990	S.RES ERJ2GEJ 221 X (220)	T	78.6/102.4
R2270	7030004970	S.RES ERJ2GEJ 470 X (47)	T	76.6/101.8
R2271	7030004990	S.RES ERJ2GEJ 221 X (220)	T	76.6/100.9
R2272	7030004990	S.RES ERJ2GEJ 221 X (220)	B	78.1/97.8
R2273	7030004990	S.RES ERJ2GEJ 221 X (220)	B	78.1/98.9
R2274	7030005000	S.RES ERJ2GEJ 471 X (470)	T	14.2/89.8
R2277	7030005090	S.RES ERJ2GEJ 104 X (100K)	T	19.3/89.5
R2278	7030005090	S.RES ERJ2GEJ 104 X (100K)	T	19.3/90.4
R2279	7030005120	S.RES ERJ2GEJ 102 X (1K)	T	66.3/107.1
R2280	7030004980	S.RES ERJ2GEJ 101 X (100)	B	69.7/110.3
R2281	7030004990	S.RES ERJ2GEJ 221 X (220)	T	7.2/101.6
R2301	7030007250	S.RES ERJ2GEJ 220 X (22)	T	23.3/106.7
R2302	7030008290	S.RES ERJ2GEJ 183 X (18K)	T	29.0/108.0
R2303	7030005710	S.RES ERJ2GEJ 121 X (120)	T	31.3/110.8
R2304	7030010900	S.RES ERJ3GEVJ 750 V (75)	T	77.8/112.0
R2311	7030006101	S.RES ERA3YED 183V (18K)	B	67.7/107.2
R2312	7030006571	S.RES ERA3YED 392V (3.9K)	B	68.6/108.4
R2401	7030005000	S.RES ERJ2GEJ 471 X (470)	B	78.8/29.6
R2402	7030005050	S.RES ERJ2GEJ 103 X (10K)	B	81.3/29.6
R2405	7030010040	S.RES ERJ2GEJ-JPW	T	92.0/5.9
R2406	7030004990	S.RES ERJ2GEJ 221 X (220)	B	90.3/100.8
R2408	7030004970	S.RES ERJ2GEJ 470 X (47)	B	90.3/99.9
R2409	7030004990	S.RES ERJ2GEJ 221 X (220)	B	87.1/68.1
R2410	7030004990	S.RES ERJ2GEJ 221 X (220)	B	90.3/65.6
R2411	7030004990	S.RES ERJ2GEJ 221 X (220)	B	87.3/67.2
R2412	7030004990	S.RES ERJ2GEJ 221 X (220)	B	91.4/68.5
R2413	7030004990	S.RES ERJ2GEJ 221 X (220)	B	87.3/66.3
R2414	7030004990	S.RES ERJ2GEJ 221 X (220)	B	90.3/64.7
R2415	7030004990	S.RES ERJ2GEJ 221 X (220)	B	87.3/65.4
R2416	7030004990	S.RES ERJ2GEJ 221 X (220)	B	90.3/63.8
R2417	7030010040	S.RES ERJ2GEJ-JPW	B	51.5/141.2
R2418	7030010040	S.RES ERJ2GEJ-JPW	T	93.4/7.8
R2501	7030005090	S.RES ERJ2GEJ 104 X (100K)	B	8.4/93.4
R2502	7030005090	S.RES ERJ2GEJ 104 X (100K)	B	8.1/95.2
R2503	7030008410	S.RES ERJ2GEJ 392 X (3.9K)	B	8.1/91.6
R2505	7030008410	S.RES ERJ2GEJ 392 X (3.9K)	B	10.7/89.2
R2506	7030005720	S.RES ERJ2GEJ 563 X (56K)	B	9.5/90.1
R2507	7030004980	S.RES ERJ2GEJ 101 X (100)	B	16.5/90.0
R2508	7030005120	S.RES ERJ2GEJ 102 X (1K)	B	10.5/88.3
R2509	7030005120	S.RES ERJ2GEJ 102 X (1K)	B	15.7/88.4
R2510	7030005120	S.RES ERJ2GEJ 102 X (1K)	B	17.4/92.8
R2513	7030005000	S.RES ERJ2GEJ 471 X (470)	B	15.8/94.0
R2551	7030005120	S.RES ERJ2GEJ 102 X (1K)	B	43.0/123.2
R2552	7030005120	S.RES ERJ2GEJ 102 X (1K)	B	43.0/122.3
R2555	7030004980	S.RES ERJ2GEJ 101 X (100)	B	51.5/119.4
R2556	7030005040	S.RES ERJ2GEJ 472 X (4.7K)	B	44.5/125.2
R2559	7030010040	S.RES ERJ2GEJ-JPW	B	49.5/124.7
R2560	7030008410	S.RES ERJ2GEJ 392 X (3.9K)	B	49.5/125.6
R2561	7030008410	S.RES ERJ2GEJ 392 X (3.9K)	B	53.0/124.7
R2562	7030008410	S.RES ERJ2GEJ 392 X (3.9K)	B	53.9/122.9
R2564	7030005090	S.RES ERJ2GEJ 104 X (100K)	B	46.1/126.1
R2565	7030009280	S.RES ERJ2GEJ 391 X	B	41.9/116.9
R2566	7030005050	S.RES ERJ2GEJ 103 X (10K)	B	59.1/126.8

[MAIN UNIT]

REF NO.	PARTS NO.	DESCRIPTION	M.	H/V LOCATION
R2567	7030005050	S.RES ERJ2GEJ 103 X (10K)	B	60.7/126.8
R2568	7030005040	S.RES ERJ2GEJ 472 X (4.7K)	B	47.8/124.7
R2569	7030005040	S.RES ERJ2GEJ 472 X (4.7K)	B	46.1/125.2
R2601	7030010040	S.RES ERJ2GEJ-JPW	B	66.8/123.5
R2602	7030005000	S.RES ERJ2GEJ 471 X (470)	B	57.2/122.7
R2603	7030005240	S.RES ERJ2GEJ 473 X (47K)	B	63.5/121.8
R2604	7030008400	S.RES ERJ2GEJ 182 X (1.8K)	B	66.7/124.4
R2605	7030005120	S.RES ERJ2GEJ 102 X (1K)	B	65.6/126.0
R2607	7030010040	S.RES ERJ2GEJ-JPW	T	40.5/132.2
R2608	7030009320	S.RES ERJ2GEJ 487 X (4.7)	B	83.9/132.8
R2611	7030005050	S.RES ERJ2GEJ 103 X (10K)	B	34.0/124.8
R2612	7030005090	S.RES ERJ2GEJ 104 X (100K)	B	38.5/125.4
R2613	7030005080	S.RES ERJ2GEJ 823 X (82K)	B	38.5/123.6
R2614	7030005120	S.RES ERJ2GEJ 102 X (1K)	B	34.7/126.6
R2617	7030005040	S.RES ERJ2GEJ 472 X (4.7K)	T	63.4/111.1
R2618	7030007340	S.RES ERJ2GEJ 153 X (15K)	T	69.4/112.7
R2619	7030005060	S.RES ERJ2GEJ 333 X (33K)	T	63.4/112.2
R2620	7030005120	S.RES ERJ2GEJ 102 X (1K)	T	78.1/100.3
R2621	7030005120	S.RES ERJ2GEJ 102 X (1K)	T	78.1/99.4
R2623	7030005240	S.RES ERJ2GEJ 473 X (47K)	T	9.9/112.9
R2624	7030004970	S.RES ERJ2GEJ 470 X (47)	B	86.9/122.0
R2628	7030005240	S.RES ERJ2GEJ 473 X (47K)	B	61.9/121.8
C5	4030017460	S.CER C1005 JB 1H 102K-T	B	47.5/30.8
C6	4030018960	S.CER C3216 JB 1C 106M-FN	T	66.3/12.0
C7	4030017330	S.CER C1005 JF 1C 104Z-T	T	73.1/12.2
C8	4030017330	S.CER C1005 JF 1C 104Z-T	T	77.3/9.1
C9	4030017330	S.CER C1005 JF 1C 104Z-T	T	73.1/14.0
C10	4030017330	S.CER C1005 JF 1C 104Z-T	T	74.8/14.9
C11	4030017330	S.CER C1005 JF 1C 104Z-T	T	73.1/17.6
C12	4030017330	S.CER C1005 JF 1C 104Z-T	T	76.4/16.7
C13	4030017330	S.CER C1005 JF 1C 104Z-T	T	72.6/16.7
C14	4030017460	S.CER C1005 JB 1H 102K-T	T	67.7/16.6
C15	4030017460	S.CER C1005 JB 1H 102K-T	T	63.7/14.8
C16	4030017460	S.CER C1005 JB 1H 102K-T	T	63.7/15.7
C17	4030017460	S.CER C1005 JB 1H 102K-T	T	62.3/18.8
C18	4030017620	S.CER C1005 CH 1H 100C-T	T	60.7/18.9
C21	4030017730	S.CER C1005 JB 1H 471K-T	T	64.5/13.9
C25	4030017580	S.CER C1005 CH 1H 060C-T	T	55.2/17.9
C26	4030017660	S.CER C1005 CH 1H 330J-T	T	55.2/18.8
C27	4030017780	S.CER C1005 JB 1H 472K-T	T	51.7/20.5
C28	4030017530	S.CER C1005 CH 1H 0R5B-T	T	53.8/17.2
C29	4030017590	S.CER C1005 CH 1H 070C-T	T	51.7/19.6
C30	4030017730	S.CER C1005 JB 1H 471K-T	T	45.9/17.5
C31	4030017530	S.CER C1005 CH 1H 0R5B-T	T	53.8/16.3
C32	4030017660	S.CER C1005 CH 1H 330J-T	T	52.1/17.4
C33	4030017580	S.CER C1005 CH 1H 060C-T	T	52.2/16.5
C34	4030017380	S.CER C1005 CH 1H 050B-T	T	56.0/15.0
C35	4030017380	S.CER C1005 CH 1H 050B-T	T	56.0/12.5
C36	4030017730	S.CER C1005 JB 1H 471K-T	T	51.0/15.7
C37	4030017780	S.CER C1005 JB 1H 472K-T	T	70.4/11.4
C38	4030017780	S.CER C1005 JB 1H 472K-T	T	45.9/18.4
C40	4030017730	S.CER C1005 JB 1H 471K-T	T	73.1/13.1
C41	4030017730	S.CER C1005 JB 1H 471K-T	T	66.9/19.7
C42	4030017730	S.CER C1005 JB 1H 471K-T	T	70.4/12.3
C43	4030017420	S.CER C1005 CH 1H 470J-T	T	45.9/16.6
C44	4030017420	S.CER C1005 CH 1H 470J-T	T	48.0/11.7
C50	4030017640	S.CER C1005 CH 1H 150J-T	B	80.5/13.6
C51	4030017640	S.CER C1005 CH 1H 150J-T	B	79.9/11.8
C52	4030017430	S.CER C1005 CH 1H 101J-T	B	79.9/12.7
C53	4030016930	S.CER C1005 JB 1A 104K-T	B	79.7/22.0
C54	4030016930	S.CER C1005 JB 1A 104K-T	T	79.8/12.9
C55	4030016930	S.CER C1005 JB 1A 104K-T	T	78.1/17.9
C56	4030018860	S.CER C1005 JB 0J 105K-T	B	65.6/22.7
C58	4030017710	S.CER C1005 CH 1H 181J-T	T	72.2/19.4
C59	4030017710	S.CER C1005 CH 1H 181J-T	T	65.5/23.7
C101	4030017330	S.CER C1005 JF 1C 104Z-T	T	10.3/15.5
C102	4030017330	S.CER C1005 JF 1C 104Z-T	T	13.2/16.9
C103	4030017330	S.CER C1005 JF 1C 104Z-T	T	13.2/17.8
C104	4030017330	S.CER C1005 JF 1C 104Z-T	T	3.3/29.9
C105	4030017330	S.CER C1005 JF 1C 104Z-T	T	13.2/19.6
C106	4030017850	S.CER C2012 CH 1H 272J-T	T	23.8/11.0
C107	4030017330	S.CER C1005 JF 1C 104Z-T	T	19.2/12.9
C108	4030017330	S.CER C1005 JF 1C 104Z-T	T	36.5/16.6
C109	4030017330	S.CER C1005 JF 1C 104Z-T	T	25.2/14.0
C110	4030017800	S.CER C1608 CH 1H 561J-T	T	27.9/7.8
C111	4030018590	S.CER C1608 CH 1H 122J-T	T	29.2/5.0
C112	4030017330	S.CER C1005 JF 1C 104Z-T	T	23.9/5.3
C114	4030018600	S.CER C1608 CH 1H 152J-T	T	25.2/15.1
C115	4030008490	S.CER C2012 JB 1H 682K-T	T	24.8/16.7

[MAIN UNIT]

REF NO.	PARTS NO.	DESCRIPTION	M.	H/V LOCATION
C213	4030017510	S.CER C1005 CH 1H 680J-T	T	21.8/43.4
C214	4030018820	S.CER C1005 JB 1H 561K-T	T	31.7/54.4
C215	4030017440	S.CER C1005 CH 1H 221J-T	T	37.0/54.6
C226	4030017330	S.CER C1005 JF 1C 104Z-T	T	24.1/43.4
C227	4030017330	S.CER C1005 JF 1C 104Z-T	T	19.8/30.3
C228	4030017430	S.CER C1005 CH 1H 101J-T	T	28.2/39.2
C229	4030017440	S.CER C1005 CH 1H 221J-T	T	29.8/39.2
C237	4030017500	S.CER C1005 CH 1H 560J-T	T	28.2/38.2
C238	4030017330	S.CER C1005 JF 1C 104Z-T	T	21.9/30.9
C239	4030017330	S.CER C1005 JF 1C 104Z-T	B	24.7/41.5
C240	4030017400	S.CER C1005 CH 1H 220J-T	B	28.2/43.7
C241	4030017580	S.CER C1005 CH 1H 060C-T	B	31.6/40.1
C242	4030017680	S.CER C1005 CH 1H 820J-T	B	31.6/41.0
C243	4030018630	S.CER C2012 CH 1H 472J-T	T	32.5/57.8
C244	4030018680	S.CER C2012 CH 1H 822J-T	T	36.8/57.8
C245	4030017330	S.CER C1005 JF 1C 104Z-T	T	45.8/63.2
C246	4030018600	S.CER C1608 CH 1H 152J-T	T	36.5/56.1
C247	4030017860	S.CER C2012 CH 1H 332J-T	T	40.3/54.1
C248	4030018630	S.CER C2012 CH 1H 472J-T	T	43.8/57.9
C249	4030017330	S.CER C1005 JF 1C 104Z-T	B	24.9/56.5
C250	4030017330	S.CER C1005 JF 1C 104Z-T	B	24.9/53.4
C251	4030018590	S.CER C1608 CH 1H 122J-T	T	30.6/51.0
C252	4030011340	S.CER C1608 CH 1H 471J-T	T	32.0/48.6
C253	4030018630	S.CER C2012 CH 1H 472J-T	T	29.1/53.3
C254	4030018620	S.CER C1608 CH 1H 222J-T	T	38.1/50.8
C255	4030018580	S.CER C1608 CH 1H 821J-T	T	32.6/55.9
C256	4030010760	S.CER C1608 CH 1H 331J-T	T	38.1/52.1
C257	4030018610	S.CER C1608 CH 1H 182J-T	T	34.4/53.4
C258	4030017870	S.CER C1608 CH 1H 681J-T	T	40.7/52.3
C259	4030018590	S.CER C1608 CH 1H 122J-T	T	37.1/53.4
C260	4030017870	S.CER C1608 CH 1H 681J-T	T	40.7/47.9
C261	4030017780	S.CER C1005 JB 1H 472K-T	B	38.0/56.3
C262	4030017780	S.CER C1005 JB 1H 472K-T	B	38.0/53.8
C263	4030017330	S.CER C1005 JF 1C 104Z-T	B	24.6/50.3
C264	4030017330	S.CER C1005 JF 1C 104Z-T	B	23.9/47.2
C265	4030011280	S.CER C1608 CH 1H 271J-T	B	36.4/46.0
C266	4030017700	S.CER C1005 CH 1H 151J-T	B	31.0/44.1
C267	4030018590	S.CER C1608 CH 1H 122J-T	B	36.4/49.6
C268	4030018580	S.CER C1608 CH 1H 821J-T	B	31.8/43.0
C269	4030017710	S.CER C1005 CH 1H 181J-T	B	36.5/47.2
C270	4030017430	S.CER C1005 CH 1H 101J-T	B	32.7/44.1
C271	4030011330	S.CER C1608 CH 1H 391J-T	B	36.4/48.3
C272	4030011280	S.CER C1608 CH 1H 271J-T	B	36.4/43.9
C273	4030011330	S.CER C1608 CH 1H 391J-T	B	38.8/47.3
C274	4030017730	S.CER C1005 JB 1H 471K-T	B	34.3/43.7
C275	4030017780	S.CER C1005 JB 1H 472K-T	B	43.0/49.7
C276	4030017780	S.CER C1005 JB 1H 472K-T	B	39.3/46.3
C278	4030017330	S.CER C1005 JF 1C 104Z-T	T	30.9/31.9
C279	4030017330	S.CER C1005 JF 1C 104Z-T	T	31.0/43.9
C281	4030017330	S.CER C1005 JF 1C 104Z-T	T	33.0/31.7
C282	4030017650	S.CER C1005 CH 1H 270J-T	B	31.6/39.2
C283	4030017330	S.CER C1005 JF 1C 104Z-T	B	35.9/35.9
C284	4030017780	S.CER C1005 JB 1H 472K-T	B	42.7/43.3
C285	4030017380	S.CER C1005 CH 1H 050B-T	B	33.2/39.5
C286	4030017510	S.CER C1005 CH 1H 680J-T	B	34.8/39.5
C287	4030017690	S.CER C1005 CH 1H 121J-T	B	36.6/37.9
C288	4030017680	S.CER C1005 CH 1H 820J-T	B	34.3/36.3
C289	4030017420	S.CER C1005 CH 1H 470J-T	B	36.4/36.8
C290	4030018600	S.CER C1608 CH 1H 152J-T	B	38.8/37.6
C291	4030017680	S.CER C1005 CH 1H 820J-T	B	38.0/36.6
C292	4030017330	S.CER C1005 JF 1C 104Z-T	T	30.9/30.1
C293	4030017780	S.CER C1005 JB 1H 472K-T	B	38.2/34.9
C294	4030017440	S.CER C1005 CH 1H 221J-T	T	38.6/49.7
C295	4030017510	S.CER C1005 CH 1H 680J-T	T	40.4/51.2
C301	4030017330	S.CER C1005 JF 1C 104Z-T	T	47.1/30.1
C302	4030017330	S.CER C1005 JF 1C 104Z-T	B	56.1/30.8
C303	4030017330	S.CER C1005 JF 1C 104Z-T	T	51.5/33.6
C305	4030017330	S.CER C1005 JF 1C 104Z-T	T	60.0/34.7
C307	4030017330	S.CER C1005 JF 1C 104Z-T	T	60.0/35.6
C308	4030017330	S.CER C1005 JF 1C 104Z-T	T	60.8/36.5
C309	4030017330	S.CER C1005 JF 1C 104Z-T	T	62.8/36.9
C310	4030017330	S.CER C1005 JF 1C 104Z-T	T	60.9/30.1
C311	4030017330	S.CER C1005 JF 1C 104Z-T	T	50.1/32.6
C312	4030017330	S.CER C1005 JF 1C 104Z-T	T	64.6/36.1
C313	4030017380	S.CER C1005 CH 1H 050B-T	T	46.5/23.1
C314	4030017660	S.CER C1005 CH 1H 330J-T	T	64.9/35.2
C315	4030017340	S.CER C1005 CH 1H 010B-T	T	49.2/23.0
C316	4030017630	S.CER C1005 CH 1H 120J-T	T	66.2/36.1
C317	4030017600	S.CER C1005 CH 1H 080C-T	T	51.5/23.9
C318	4030017680	S.CER C1005 CH 1H 820J-T	T	66.5/35.2
C319	4030017570	S.CER C1005 CH 1H 040B-T	T	53.1/24.3
C320	4030017570	S.CER C1005 CH 1H 040B-T	T	69.7/37.1
C321	4030017580	S.CER C1005 CH 1H 060C-T	T	58.7/24.4
C322	4030017670	S.CER C1005 CH 1H 390J-T	T	69.0/32.2
C323	4030017590	S.CER C1005 CH 1H 070C-T	T	60.4/24.3
C324	4030017330	S.CER C1005 JF 1C 104Z-T	T	74.8/38.6
C325	4030017360	S.CER C1005 CH 1H 030B-T	T	62.1/24.6
C326	4030017780	S.CER C1005 JB 1H 472K-T	T	47.6/47.1
C401	4030017330	S.CER C1005 JF 1C 104Z-T	T	71.0/30.9
C413	4030017330	S.CER C1005 JF 1C 104Z-T	T	80.6/24.0
C415	4030017330	S.CER C1005 JF 1C 104Z-T	T	72.0/24.1
C418	4030017330	S.CER C1005 JF 1C 104Z-T	T	67.5/24.8
C422	4030017330	S.CER C1005 JF 1C 104Z-T	T	80.1/28.6
C423	4030017330	S.CER C1005 JF 1C 104Z-T	T	67.5/23.9
C424	4030017330	S.CER C1005 JF 1C 104Z-T	T	83.3/21.1
C425	4030017330	S.CER C1005 JF 1C 104Z-T	T	86.9/27.7
C426	4030017330	S.CER C1005 JF 1C 104Z-T	T	78.6/19.9
C427	4030017330	S.CER C1005 JF 1C 104Z-T	T	80.1/27.7

[MAIN UNIT]

REF NO.	PARTS NO.	DESCRIPTION	M.	H/V LOCATION
C429	4030017460	S.CER C1005 JB 1H 102K-T	T	81.8/25.3
C431	4030017330	S.CER C1005 JF 1C 104Z-T	T	88.6/26.7
C432	4030017780	S.CER C1005 JB 1H 472K-T	B	88.6/19.3
C433	4030017780	S.CER C1005 JB 1H 472K-T	T	88.9/20.3
C434	4030017780	S.CER C1005 JB 1H 472K-T	T	86.8/23.0
C511	4030017460	S.CER C1005 JB 1H 102K-T	T	41.9/26.8
C512	4030017780	S.CER C1005 JB 1H 472K-T	T	93.6/33.5
C513	4030017330	S.CER C1005 JF 1C 104Z-T	T	88.5/20.3
C514	4030017330	S.CER C1005 JF 1C 104Z-T	B	88.3/31.7
C515	4030017780	S.CER C1005 JB 1H 472K-T	T	81.8/33.2
C516	4030017580	S.CER C1005 CH 1H 060C-T	T	86.1/38.7
C518	4030017570	S.CER C1005 CH 1H 040B-T	T	86.9/36.5
C525	4030017330	S.CER C1005 JF 1C 104Z-T	T	81.8/32.3
C526	4030016790	S.CER C1005 JB 1E 103K-T	T	78.0/38.3
C527	4030017330	S.CER C1005 JF 1C 104Z-T	T	79.6/38.0
C528	4030017330	S.CER C1005 JF 1C 104Z-T	T	89.7/35.2
C529	4030017670	S.CER C1005 CH 1H 390J-T	T	91.3/33.8
C530	4030017460	S.CER C1005 JB 1H 102K-T	B	87.7/34.2
C602	4030017570	S.CER C1005 CH 1H 040B-T	B	85.7/39.7
C603	4030017780	S.CER C1005 JB 1H 472K-T	T	89.2/40.1
C604	4030017780	S.CER C1005 JB 1H 472K-T	T	94.1/46.5
C605	4030017620	S.CER C1005 CH 1H 100C-T	T	86.0/44.2
C606	4030017620	S.CER C1005 CH 1H 100C-T	B	85.7/41.5
C608	4030017550	S.CER C1005 CH 1H 1R5B-T	B	82.6/43.9
C609	4030017580	S.CER C1005 CH 1H 060C-T	B	78.7/46.8
C610	4030017620	S.CER C1005 CH 1H 100C-T	B	82.6/44.8
C611	4030017780	S.CER C1005 JB 1H 472K-T	B	85.2/37.6
C612	4030017610	S.CER C1005 CH 1H 090C-T	T	79.5/40.5
C613	4030017620	S.CER C1005 CH 1H 100C-T	T	76.6/43.8
C614	4030017780	S.CER C1005 JB 1H 472K-T	T	69.7/38.9
C615	4030017780	S.CER C1005 JB 1H 472K-T	T	64.3/43.1
C616	4030017780	S.CER C1005 JB 1H 472K-T	T	77.4/39.5
C617	4030017620	S.CER C1005 CH 1H 100C-T	B	85.7/40.6
C618	4030017620	S.CER C1005 CH 1H 100C-T	B	81.0/44.8
C701	4030017330	S.CER C1005 JF 1C 104Z-T	T	59.0/50.7
C702	4030017330	S.CER C1005 JF 1C 104Z-T	T	63.0/45.1
C703	4510008630	S.ELE 16 CE 47 FE	B	59.0/40.5
C704	4030017780	S.CER C1005 JB 1H 472K-T	T	58.7/43.0
C705	4030017600	S.CER C1005 CH 1H 080C-T	T	59.6/45.1
C707	4030017330	S.CER C1005 JF 1C 104Z-T	T	64.3/53.0
C708	4030017460	S.CER C1005 JB 1H 102K-T	T	64.6/55.8
C709	4030017780	S.CER C1005 JB 1H 472K-T	T	60.7/58.7
C710	4030017780	S.CER C1005 JB 1H 472K-T	T	62.3/58.6
C711	4030017460	S.CER C1005 JB 1H 102K-T	T	57.2/50.7
C712	4030017600	S.CER C1005 CH 1H 080C-T	T	52.4/50.3
C714	4030017460	S.CER C1005 JB 1H 102K-T	T	56.2/49.8
C715	4030017780	S.CER C1005 JB 1H 472K-T	T	55.2/53.3
C716	4030017340	S.CER C1005 CH 1H 010B-T	T	52.4/55.2
C717	4030017780	S.CER C1005 JB 1H 472K-T	T	51.2/52.4
C718	4030017780	S.CER C1005 JB 1H 472K-T	T	57.0/55.2
C719	4030017340	S.CER C1005 CH 1H 010B-T	T	61.2/53.9
C720	4030017380	S.CER C1005 CH 1H 050B-T	T	59.4/42.1
C721	4030017780	S.CER C1005 JB 1H 472K-T	T	51.2/49.7
C801	4030017330	S.CER C1005 JF 1C 104Z-T	T	71.5/64.1
C803	4030017780	S.CER C1005 JB 1H 472K-T	T	65.3/61.8
C804	4030017330	S.CER C1005 JF 1C 104Z-T	T	92.0/58.1
C805	4030017460	S.CER C1005 JB 1H 102K-T	T	83.5/55.8
C807	4030017330	S.CER C1005 JF 1C 104Z-T	T	60.6/66.7
C808	4030017870	S.CER C1608 CH 1H 681J-T	T	60.4/65.5
C809	4030018630	S.CER C2012 CH 1H 472J-T	T	57.5/66.8
C810	4030017700	S.CER C1005 CH 1H 151J-T	T	63.9/68.5
C811	4030017700	S.CER C1005 CH 1H 151J-T	T	63.9/69.4
C812	4030017700	S.CER C1005 CH 1H 151J-T	T	60.1/69.4
C813	4030017700	S.CER C1005 CH 1H 151J-T	T	60.1/68.5
C814	4030017330	S.CER C1005 JF 1C 104Z-T	T	88.6/57.2
C815	4030017460	S.CER C1005 JB 1H 102K-T	T	86.7/60.6
C816	4030017400	S.CER C1005 CH 1H 220J-T	T	85.8/59.7
C817	4030017400	S.CER C1005 CH 1H 220J-T	T	84.1/61.8
C818	4030018590	S.CER C1608 CH 1H 122J-T	T	54.6/65.7
C819	4030017850	S.CER C2012 CH 1H 272J-T	T	51.7/65.9
C901	4030017330	S.CER C1005 JF 1C 104Z-T	T	38.4/71.3
C910	4030017710	S.CER C1005 CH 1H 181J-T	T	39.3/65.7
C911	4030017700	S.CER C1005 CH 1H 151J-T	T	48.0/77.8
C913	4030017330	S.CER C1005 JF 1C 104Z-T	T	38.3/61.1
C914	4030017330	S.CER C1005 JF 1C 104Z-T	T	39.3/63.6
C916	4030017330	S.CER C1005 JF 1C 104Z-T	T	34.0/62.0
C917	4030017780			

[MAIN UNIT]

REF NO.	PARTS NO.	DESCRIPTION	M.	H/V LOCATION
C1201	4030017330	S.CER C1005 JF 1C 104Z-T	T	26.7/80.6
C1202	4030017330	S.CER C1005 JF 1C 104Z-T	T	28.7/80.5
C1203	4030017330	S.CER C1005 JF 1C 104Z-T	T	18.6/79.2
C1204	4030018960	S.CER C3216 JB 1C 106MT-N	T	9.1/77.0
C1206	4030017780	S.CER C1005 JB 1H 472K-T	T	14.3/79.4
C1207	4030017780	S.CER C1005 JB 1H 472K-T	T	12.7/78.5
C1208	4030018080	S.CER C1005 JB 1H 182K-T	T	13.0/85.0
C1209	4030018820	S.CER C1005 JB 1H 561K-T	T	13.0/84.1
C1210	4030017780	S.CER C1005 JB 1H 472K-T	T	11.4/84.1
C1211	4030017490	S.CER C1608 JB 1A 105K-T	T	9.2/84.5
C1212	4030017490	S.CER C1608 JB 1A 105K-T	T	6.8/87.8
C1213	4030017330	S.CER C1005 JF 1C 104Z-T	T	21.9/78.3
C1301	4030017330	S.CER C1005 JF 1C 104Z-T	T	15.3/73.6
C1302	4030017330	S.CER C1005 JF 1C 104Z-T	T	15.1/67.4
C1303	4030018860	S.CER C1005 JB 0J 105K-T	T	11.4/67.4
C1304	4030017330	S.CER C1005 JF 1C 104Z-T	T	14.4/69.2
C1305	4030017330	S.CER C1005 JF 1C 104Z-T	T	11.6/65.6
C1306	4030017330	S.CER C1005 JF 1C 104Z-T	T	10.9/60.3
C1307	4030017330	S.CER C1005 JF 1C 104Z-T	T	16.2/65.6
C1308	4030017330	S.CER C1005 JF 1C 104Z-T	T	14.5/60.3
C1309	4030017330	S.CER C1005 JF 1C 104Z-T	T	3.8/50.8
C1310	4030017330	S.CER C1005 JF 1C 104Z-T	T	16.2/62.9
C1311	4030018960	S.CER C3216 JB 1C 106MT-N	T	5.4/58.5
C1312	4030018860	S.CER C1005 JB 0J 105K-T	T	13.0/66.5
C1401	4030017330	S.CER C1005 JF 1C 104Z-T	B	46.6/77.4
C1402	4030017700	S.CER C1005 CH 1H 151J-T	B	42.0/69.7
C1403	4030017650	S.CER C1005 CH 1H 270J-T	B	45.5/71.5
C1404	4030017700	S.CER C1005 CH 1H 151J-T	B	42.0/70.6
C1405	4030017780	S.CER C1005 JB 1H 472K-T	B	43.7/71.5
C1406	4030017780	S.CER C1005 JB 1H 472K-T	B	42.0/72.4
C1407	4030017780	S.CER C1005 JB 1H 472K-T	B	44.7/74.4
C1408	4030017780	S.CER C1005 JB 1H 472K-T	B	40.4/79.1
C1409	4030017780	S.CER C1005 JB 1H 472K-T	B	34.7/79.1
C1411	4030018860	S.CER C1005 JB 0J 105K-T	B	27.0/80.0
C1412	4030016950	S.CER C1005 JB 1A 473K-T	B	27.1/80.9
C1413	4030017490	S.CER C1608 JB 1A 105K-T	B	20.7/77.5
C1414	4030016950	S.CER C1005 JB 1A 473K-T	B	25.1/77.8
C1415	4510008640	S.ELE 6 CE 100 FE	B	13.2/81.2
C1416	4030016950	S.CER C1005 JB 1A 473K-T	B	20.2/78.5
C1418	4030017350	S.CER C1005 CH 1H 020B-T	B	23.1/86.6
C1419	4030018390	S.CER C1005 JB 1A 563K-T	B	23.1/87.5
C1420	4030017420	S.CER C1005 CH 1H 470J-T	B	17.9/83.1
C1421	4030018960	S.CER C3216 JB 1C 106MT-N	B	19.8/87.3
C1422	4030017640	S.CER C1005 CH 1H 150J-T	B	17.9/82.2
C1423	4610001970	S.TRI TZC3P200A110R00 (TZC03P200A1102)	T	3.9/72.6
C1491	4030017670	S.CER C1005 CH 1H 390J-T	[EUR] B	88.2/29.4
	4030017670	S.CER C1005 CH 1H 390J-T	[FRA]	
	4030017670	S.CER C1005 CH 1H 390J-T	[ESP]	
	4030017400	S.CER C1005 CH 1H 220J-T	[USA]	
	4030017670	S.CER C1005 CH 1H 390J-T	[EXP]	
	4030017670	S.CER C1005 CH 1H 390J-T	[ITR]	
	4030017670	S.CER C1005 CH 1H 390J-T	[UK]	
	4030017400	S.CER C1005 CH 1H 220J-T	[KOR]	
	4030017670	S.CER C1005 CH 1H 390J-T	[AUS]	
	4030017670	S.CER C1005 CH 1H 390J-T	[CHN]	
C1493	4030017660	S.CER C1005 CH 1H 330J-T	B	86.1/33.8
C1494	4030017670	S.CER C1005 CH 1H 390J-T	[EUR] B	83.7/34.0
	4030017670	S.CER C1005 CH 1H 390J-T	[FRA]	
	4030017670	S.CER C1005 CH 1H 390J-T	[ESP]	
	4030017420	S.CER C1005 CH 1H 470J-T	[USA]	
	4030017670	S.CER C1005 CH 1H 390J-T	[EXP]	
	4030017670	S.CER C1005 CH 1H 390J-T	[ITR]	
	4030017670	S.CER C1005 CH 1H 390J-T	[UK]	
	4030017420	S.CER C1005 CH 1H 470J-T	[KOR]	
	4030017670	S.CER C1005 CH 1H 390J-T	[AUS]	
	4030017670	S.CER C1005 CH 1H 390J-T	[CHN]	
C1495	4030011280	S.CER C1608 CH 1H 271J-T	[EUR] B	84.0/33.0
	4030011280	S.CER C1608 CH 1H 271J-T	[FRA]	
	4030011280	S.CER C1608 CH 1H 271J-T	[ESP]	
	4030010760	S.CER C1608 CH 1H 331J-T	[USA]	
	4030011280	S.CER C1608 CH 1H 271J-T	[EXP]	
	4030011280	S.CER C1608 CH 1H 271J-T	[ITR]	
	4030011280	S.CER C1608 CH 1H 271J-T	[UK]	
	4030010760	S.CER C1608 CH 1H 331J-T	[KOR]	
	4030011280	S.CER C1608 CH 1H 271J-T	[AUS]	
	4030011280	S.CER C1608 CH 1H 271J-T	[CHN]	
C1496	4030017660	S.CER C1005 CH 1H 330J-T	B	79.3/35.3
C1498	4030017670	S.CER C1005 CH 1H 390J-T	[EUR] B	79.4/36.2
	4030017670	S.CER C1005 CH 1H 390J-T	[FRA]	
	4030017670	S.CER C1005 CH 1H 390J-T	[ESP]	
	4030017400	S.CER C1005 CH 1H 220J-T	[USA]	
	4030017670	S.CER C1005 CH 1H 390J-T	[EXP]	
	4030017670	S.CER C1005 CH 1H 390J-T	[ITR]	
	4030017670	S.CER C1005 CH 1H 390J-T	[UK]	
	4030017400	S.CER C1005 CH 1H 220J-T	[KOR]	
	4030017670	S.CER C1005 CH 1H 390J-T	[AUS]	
	4030017670	S.CER C1005 CH 1H 390J-T	[CHN]	
C1501	4030017410	S.CER C1005 CH 1H 240J-T	B	79.4/37.1
C1503	4030017330	S.CER C1005 JF 1C 104Z-T	B	79.0/62.0
C1504	4030017510	S.CER C1005 CH 1H 680J-T	B	81.0/36.5
C1506	4030017780	S.CER C1005 JB 1H 472K-T	B	92.1/28.9
C1507	4030017410	S.CER C1005 CH 1H 240J-T	B	82.6/36.5
C1508	4030017780	S.CER C1005 JB 1H 472K-T	B	77.3/38.6
C1509	4030017780	S.CER C1005 JB 1H 472K-T	B	72.4/39.2
C1510	4030017780	S.CER C1005 JB 1H 472K-T	B	72.4/41.2
C1511	4030016790	S.CER C1005 JB 1E 103K-T	B	86.5/56.3
C1512	4030017780	S.CER C1005 JB 1H 472K-T	B	77.0/41.6

[MAIN UNIT]

REF NO.	PARTS NO.	DESCRIPTION	M.	H/V LOCATION
C1513	4030018900	S.CER C1005 JB 0J 474K-T	B	73.7/55.2
C1514	4030017780	S.CER C1005 JB 1H 472K-T	B	73.5/42.1
C1515	4030018960	S.CER C3216 JB 1C 106MT-N	B	68.3/53.7
C1516	4030017330	S.CER C1005 JF 1C 104Z-T	B	76.0/51.9
C1517	4030017730	S.CER C1005 JB 1H 471K-T	B	73.4/54.0
C1518	4030016790	S.CER C1005 JB 1E 103K-T	B	85.8/51.4
C1519	4030018960	S.CER C3216 JB 1C 106MT-N	B	69.0/47.4
C1520	4510008630	S.ELE 16 CE 47 FE	B	91.3/45.5
C1521	4030017680	S.CER C1005 CH 1H 820J-T	B	85.9/58.0
C1522	4030017670	S.CER C1005 CH 1H 390J-T	T	73.2/55.4
C1523	4030017330	S.CER C1005 JF 1C 104Z-T	T	31.2/80.4
C1524	4030017420	S.CER C1005 CH 1H 470J-T	[EUR] B	73.7/60.6
	4030017420	S.CER C1005 CH 1H 470J-T	[FRA]	
	4030017420	S.CER C1005 CH 1H 470J-T	[ESP]	
	4030017510	S.CER C1005 CH 1H 680J-T	[USA]	
	4030017420	S.CER C1005 CH 1H 470J-T	[EXP]	
	4030017420	S.CER C1005 CH 1H 470J-T	[ITR]	
	4030017420	S.CER C1005 CH 1H 470J-T	[UK]	
	4030017510	S.CER C1005 CH 1H 680J-T	[KOR]	
	4030017420	S.CER C1005 CH 1H 470J-T	[AUS]	
	4030017420	S.CER C1005 CH 1H 470J-T	[CHN]	
C1525	4030018900	S.CER C1005 JB 0J 474K-T	B	85.9/60.0
C1526	4030018960	S.CER C3216 JB 1C 106MT-N	B	69.3/51.6
C1531	4030017490	S.CER C1608 JB 1A 105K-T	B	83.3/51.6
C1532	4030017780	S.CER C1005 JB 1H 472K-T	B	81.9/41.3
C1533	4030017780	S.CER C1005 JB 1H 472K-T	B	81.9/39.5
C1534	4030017780	S.CER C1005 JB 1H 472K-T	B	83.6/38.5
C1601	4030017780	S.CER C1005 JB 1H 472K-T	T	6.3/52.3
C1604	4030017780	S.CER C1005 JB 1H 472K-T	T	5.6/50.8
C1605	4030017330	S.CER C1005 JF 1C 104Z-T	T	8.8/48.7
C1607	4030017780	S.CER C1005 JB 1H 472K-T	T	14.8/46.0
C1609	4030017490	S.CER C1608 JB 1A 105K-T	T	14.1/33.7
C1610	4030017330	S.CER C1005 JF 1C 104Z-T	T	12.1/44.8
C1611	4030017330	S.CER C1005 JF 1C 104Z-T	T	14.6/41.1
C1613	4030017330	S.CER C1005 JF 1C 104Z-T	T	19.0/47.1
C1614	4030017730	S.CER C1005 JB 1H 471K-T	T	15.1/36.2
C1615	4030017420	S.CER C1005 CH 1H 470J-T	T	10.4/46.9
C1616	4550007260	S.TAN F931C475MAABMA	T	9.7/50.6
C1618	4030017430	S.CER C1005 CH 1H 101J-T	T	12.7/26.3
C1701	4030017490	S.CER C1608 JB 1A 105K-T	B	55.1/50.5
C1702	4030017490	S.CER C1608 JB 1A 105K-T	B	55.0/69.7
C1801	4030017330	S.CER C1005 JF 1C 104Z-T	B	18.4/105.0
C1802	4510008630	S.ELE 16 CE 47 FE	B	14.5/101.3
C1803	4030018960	S.CER C3216 JB 1C 106MT-N	B	22.3/112.2
C1804	4030017330	S.CER C1005 JF 1C 104Z-T	B	22.9/110.6
C1901	4030017330	S.CER C1005 JF 1C 104Z-T	T	36.2/80.4
C1902	4030017330	S.CER C1005 JF 1C 104Z-T	T	33.7/80.4
C1903	4030017330	S.CER C1005 JF 1C 104Z-T	B	23.3/18.9
C1904	4030017330	S.CER C1005 JF 1C 104Z-T	B	32.5/89.9
C1905	4030017330	S.CER C1005 JF 1C 104Z-T	B	26.0/33.8
C1906	4030017330	S.CER C1005 JF 1C 104Z-T	B	26.0/32.9
C1907	4030017330	S.CER C1005 JF 1C 104Z-T	T	41.7/80.4
C1908	4030017330	S.CER C1005 JF 1C 104Z-T	T	38.5/80.7
C1909	4030017330	S.CER C1005 JF 1C 104Z-T	B	21.7/14.0
C1910	4030017460	S.CER C1005 JB 1H 102K-T	B	45.4/25.5
C1916	4030018960	S.CER C3216 JB 1C 106MT-N	B	14.8/50.6
C1917	4030018960	S.CER C3216 JB 1C 106MT-N	B	5.4/52.8
C1951	4030018960	S.CER C3216 JB 1C 106MT-N	B	48.1/103.1
C1952	4030018960	S.CER C3216 JB 1C 106MT-N	B	48.1/98.9
C1953	4030018960	S.CER C3216 JB 1C 106MT-N	B	48.1/96.8
C1954	4030018960	S.CER C3216 JB 1C 106MT-N	B	48.1/105.2
C1955	4030018960	S.CER C3216 JB 1C 106MT-N	B	48.1/101.0
C1956	4030018960	S.CER C3216 JB 1C 106MT-N	B	60.9/118.7
C1957	4030017330	S.CER C1005 JF 1C 104Z-T	B	63.8/116.7
C1958	4030018910	S.CER C1608 JB 0J 475K-T	B	20.9/125.7
C1959	4550007090	S.TAN TEESVA 1A 226M8R	B	11.7/120.2
C1960	4030010210	S.CER C3216 JB 1C 105M-T	B	47.3/109.8
C1961	4030017730	S.CER C1005 JB 1H 471K-T	B	44.1/110.1
C1962	4030017440	S.CER C1005 CH 1H 221J-T	B	44.7/108.4
C1963	4030017500	S.CER C1005 CH 1H 560J-T	B	35.3/105.2
C1964	4030017330	S.CER C1005 JF 1C 104Z-T	B	44.3/111.4
C1965	4030018960	S.CER C3216 JB 1C 106MT-N	B	7.5/108.1
C1966	4030017330	S.CER C1005 JF 1C 104Z-T	B	10.2/103.1
C1968	4030018960	S.CER C3216 JB 1C 106MT-N	B	31.8/103.6
C1969	4030018970	S.CER C3225 JB 1C 226MT-N	B	30.9/101.0
C1970	4030018970	S.CER C3225 JB 1C 226MT-N	B	30.9/98.0
C1971	4030017330	S.CER C1005 JF 1C 104Z-T	B	45.9/111.4
C1972	4030017330	S.CER C1005 JF 1C 104Z-T	B	47.6/106.8
C1973	4030017330	S.CER C1005 JF 1C 104Z-T	B	32.1/105.2
C2001	4030017780	S.CER C1005 JB 1H 472K-T	T	33.3/10.4
C2002	4030017330	S.CER C1005 JF 1C 104Z-T	B	71.7/14.7
C2003	4030017780	S.CER C1005 JB 1H 472K-T	B	58.8/15.8
C2004	4030017780	S.CER C1005 JB 1H 472K-T	B	83.1/6.0
C2005	4030017780	S.CER		

[MAIN UNIT]

REF NO.	PARTS NO.	DESCRIPTION	M.	H/V LOCATION
C2020	4030017330	S.CER C1005 JF 1C 104Z-T	B	84.2/23.1
C2021	4030017780	S.CER C1005 JB 1H 472K-T	B	32.5/16.1
C2022	4030017780	S.CER C1005 JB 1H 472K-T	B	30.3/130.3
C2024	4030017780	S.CER C1005 JB 1H 472K-T	B	28.8/128.3
C2025	4030017780	S.CER C1005 JB 1H 472K-T	B	45.0/12.6
C2026	4030018960	S.CER C3216 JB 1C 106MT-N	B	10.2/23.5
C2027	4030018960	S.CER C3216 JB 1C 106MT-N	B	10.2/14.7
C2028	4030017330	S.CER C1005 JF 1C 104Z-T	B	51.8/12.3
C2029	4030017330	S.CER C1005 JF 1C 104Z-T	B	58.1/9.4
C2030	4030017330	S.CER C1005 JF 1C 104Z-T	B	55.9/15.8
C2032	4030017780	S.CER C1005 JB 1H 472K-T	B	27.4/129.0
C2033	4030017330	S.CER C1005 JF 1C 104Z-T	B	71.1/21.9
C2034	4030017780	S.CER C1005 JB 1H 472K-T	B	64.9/5.6
C2035	4030017780	S.CER C1005 JB 1H 472K-T	B	25.7/130.2
C2036	4030017330	S.CER C1005 JF 1C 104Z-T	B	88.2/8.0
C2037	4030017330	S.CER C1005 JF 1C 104Z-T	B	76.4/16.5
C2038	4030017780	S.CER C1005 JB 1H 472K-T	T	14.5/126.5
C2039	4030017780	S.CER C1005 JB 1H 472K-T	B	80.2/6.8
C2040	4030017780	S.CER C1005 JB 1H 472K-T	B	64.6/17.7
C2041	4030017330	S.CER C1005 JF 1C 104Z-T	B	75.2/10.5
C2042	4030017330	S.CER C1005 JF 1C 104Z-T	B	62.8/18.2
C2043	4030017780	S.CER C1005 JB 1H 472K-T	B	55.4/8.9
C2044	4030017780	S.CER C1005 JB 1H 472K-T	B	62.8/19.5
C2045	4030017780	S.CER C1005 JB 1H 472K-T	B	64.4/21.9
C2046	4030017780	S.CER C1005 JB 1H 472K-T	B	63.7/14.6
C2047	4030017780	S.CER C1005 JB 1H 472K-T	B	57.8/22.0
C2048	4030017780	S.CER C1005 JB 1H 472K-T	B	63.2/5.6
C2049	4030017780	S.CER C1005 JB 1H 472K-T	T	45.1/101.9
C2050	4030017780	S.CER C1005 JB 1H 472K-T	T	42.9/100.3
C2051	4030017330	S.CER C1005 JF 1C 104Z-T	T	56.3/100.0
C2052	4030017780	S.CER C1005 JB 1H 472K-T	T	21.6/108.1
C2053	4030017780	S.CER C1005 JB 1H 472K-T	T	49.9/107.6
C2054	4030018960	S.CER C3216 JB 1C 106MT-N	B	55.4/83.4
C2055	4030018960	S.CER C3216 JB 1C 106MT-N	B	28.2/86.6
C2058	4030018960	S.CER C3216 JB 1C 106MT-N	B	16.4/95.6
C2062	4550007710	S.TAN TEESVB2 1A 476M8R	B	26.6/13.0
C2063	4030017780	S.CER C1005 JB 1H 471K-T	B	46.1/13.8
C2064	4030018960	S.CER C3216 JB 1C 106MT-N	B	61.1/23.1
C2065	4030016930	S.CER C1005 JB 1A 104K-T	B	73.4/1.3
C2066	4030016930	S.CER C1005 JB 1A 104K-T	B	75.1/1.3
C2067	4030017430	S.CER C1005 CH 1H 101J-T	B	56.9/20.0
C2068	4030017460	S.CER C1005 JB 1H 102K-T	B	59.2/26.1
C2069	4030017780	S.CER C1005 JB 1H 471K-T	B	46.6/12.1
C2101	4030017330	S.CER C1005 JF 1C 104Z-T	T	28.4/113.8
C2102	4030017330	S.CER C1005 JF 1C 104Z-T	T	44.8/111.0
C2103	4030018960	S.CER C3216 JB 1C 106MT-N	T	28.9/112.3
C2104	4030017330	S.CER C1005 JF 1C 104Z-T	T	56.2/123.5
C2105	4030018960	S.CER C3216 JB 1C 106MT-N	T	54.8/125.1
C2156	4030017330	S.CER C1005 JF 1C 104Z-T	T	36.2/122.1
C2157	4030017330	S.CER C1005 JF 1C 104Z-T	B	34.5/91.1
C2158	4030017330	S.CER C1005 JF 1C 104Z-T	B	27.4/93.8
C2159	4030017330	S.CER C1005 JF 1C 104Z-T	T	22.5/94.5
C2160	4030017330	S.CER C1005 JF 1C 104Z-T	B	38.3/88.9
C2161	4030018960	S.CER C3216 JB 1C 106MT-N	T	36.8/123.7
C2162	4030018960	S.CER C3216 JB 1C 106MT-N	B	37.7/90.4
C2163	4030017780	S.CER C1005 JB 1H 472K-T	T	4.7/116.5
C2164	4030018960	S.CER C3216 JB 1C 106MT-N	T	6.5/115.0
C2166	4030012610	S.CER C2012 JB 1C 474K-T	T	5.3/106.9
C2167	4030018960	S.CER C3216 JB 1C 106MT-N	T	5.0/110.0
C2168	4030012610	S.CER C2012 JB 1C 474K-T	T	16.6/116.8
C2169	4030016930	S.CER C1005 JB 1A 104K-T	T	14.0/124.3
C2201	4030017780	S.CER C1005 JB 1H 472K-T	T	24.8/125.9
C2203	4030018520	S.CER C1608 JB 0J 225M-T	T	16.1/118.5
C2204	4030017330	S.CER C1005 JF 1C 104Z-T	T	11.2/119.7
C2205	4030018960	S.CER C3216 JB 1C 106MT-N	T	12.4/117.2
C2206	4030017780	S.CER C1005 JB 1H 472K-T	T	21.7/115.7
C2208	4030017780	S.CER C1005 JB 1H 471K-T	T	19.0/117.0
C2211	4030018960	S.CER C3216 JB 1C 106MT-N	T	22.5/120.0
C2212	4030018960	S.CER C3216 JB 1C 106MT-N	T	23.3/124.3
C2213	4550007140	S.TAN TEESVD 1C 107M12R	T	37.7/138.5
C2214	4030018910	S.CER C1608 JB 0J 475K-T	T	20.9/122.6
C2231	4030017330	S.CER C1005 JF 1C 104Z-T	T	38.3/105.6
C2232	4030018960	S.CER C3216 JB 1C 106MT-N	T	38.2/104.0
C2233	4030017780	S.CER C1005 JB 1H 472K-T	T	4.7/123.3
C2234	4550007310	S.TAN F930J227MNMNMBMA	T	70.1/130.6
C2235	4030018960	S.CER C3216 JB 1C 106MT-N	T	41.0/108.8
C2236	4030018960	S.CER C3216 JB 1C 106MT-N	T	39.9/111.2
C2237	4030017460	S.CER C1005 JB 1H 102K-T	T	60.6/123.4
C2254	4030017330	S.CER C1005 JF 1C 104Z-T	T	7.7/92.5
C2255	4030017330	S.CER C1005 JF 1C 104Z-T	B	2.5/98.2
C2256	4030017330	S.CER C1005 JF 1C 104Z-T	B	2.6/95.7
C2257	4030017330	S.CER C1005 JF 1C 104Z-T	T	9.9/88.0
C2260	4030017330	S.CER C1005 JF 1C 104Z-T	T	18.6/103.7
C2261	4030017330	S.CER C1005 JF 1C 104Z-T	T	6.7/104.4
C2262	4030017330	S.CER C1005 JF 1C 104Z-T	T	58.5/100.4
C2264	4030017330	S.CER C1005 JF 1C 104Z-T	T	61.9/88.9
C2266	4030017330	S.CER C1005 JF 1C 104Z-T	T	72.0/85.3
C2268	4030017330	S.CER C1005 JF 1C 104Z-T	T	68.6/89.5
C2269	4030017330	S.CER C1005 JF 1C 104Z-T	B	78.5/92.4
C2270	4030017780	S.CER C1005 JB 1H 472K-T	T	61.9/89.8
C2272	4030017330	S.CER C1005 JF 1C 104Z-T	T	56.3/92.3
C2274	4030017330	S.CER C1005 JF 1C 104Z-T	T	55.8/95.0
C2275	4030017330	S.CER C1005 JF 1C 104Z-T	B	68.2/99.3
C2276	4030017330	S.CER C1005 JF 1C 104Z-T	B	64.2/100.6
C2277	4030017330	S.CER C1005 JF 1C 104Z-T	T	63.6/103.5
C2278	4030017330	S.CER C1005 JF 1C 104Z-T	T	63.7/108.0
C2279	4030017330	S.CER C1005 JF 1C 104Z-T	T	62.8/108.9
C2280	4030017420	S.CER C1005 CH 1H 470J-T	T	51.8/37.9

[MAIN UNIT]

REF NO.	PARTS NO.	DESCRIPTION	M.	H/V LOCATION
C2281	4030017330	S.CER C1005 JF 1C 104Z-T	T	68.6/90.4
C2282	4030017330	S.CER C1005 JF 1C 104Z-T	B	80.5/93.1
C2283	4030017330	S.CER C1005 JF 1C 104Z-T	B	81.7/92.2
C2285	4030017330	S.CER C1005 JF 1C 104Z-T	T	50.8/99.1
C2286	4030017330	S.CER C1005 JF 1C 104Z-T	T	14.2/88.9
C2301	4030018910	S.CER C1608 JB 0J 475K-T	T	30.8/106.9
C2302	4030018910	S.CER C1608 JB 0J 475K-T	T	27.9/109.5
C2303	4550007310	S.TAN F930J227MNMNMBMA	T	84.4/110.4
C2311	4030017330	S.CER C1005 JF 1C 104Z-T	B	68.1/110.3
C2312	4030018910	S.CER C1608 JB 0J 475K-T	T	67.4/105.0
C2401	4030017330	S.CER C1005 JF 1C 104Z-T	B	90.8/103.8
C2402	4030017330	S.CER C1005 JF 1C 104Z-T	B	81.2/100.7
C2403	4030017780	S.CER C1005 JB 1H 472K-T	B	77.2/28.8
C2405	4030017330	S.CER C1005 JF 1C 104Z-T	T	74.3/79.3
C2406	4030017460	S.CER C1005 JB 1H 102K-T	B	88.5/99.8
C2407	4030017330	S.CER C1005 JF 1C 104Z-T	T	74.1/78.2
C2408	4030017330	S.CER C1005 JF 1C 104Z-T	B	84.9/96.2
C2409	4030017330	S.CER C1005 JF 1C 104Z-T	T	75.6/77.6
C2410	4030017330	S.CER C1005 JF 1C 104Z-T	B	88.5/85.8
C2411	4030017330	S.CER C1005 JF 1C 104Z-T	B	81.1/96.5
C2412	4510008630	S.ELE 16 CE 47 FE	B	62.1/30.4
C2413	4030017330	S.CER C1005 JF 1C 104Z-T	B	88.5/93.7
C2414	4030017780	S.CER C1005 JB 1H 472K-T	T	84.0/95.6
C2415	4030017780	S.CER C1005 JB 1H 472K-T	B	88.4/28.1
C2417	4030017330	S.CER C1005 JF 1C 104Z-T	B	88.4/27.2
C2418	4030017330	S.CER C1005 JF 1C 104Z-T	B	82.6/94.1
C2419	4030017330	S.CER C1005 JF 1C 104Z-T	B	88.5/86.7
C2422	4030017330	S.CER C1005 JF 1C 104Z-T	T	84.8/87.3
C2423	4030017420	S.CER C1005 CH 1H 470J-T	B	62.2/141.2
C2424	4510008630	S.ELE 16 CE 47 FE	B	69.2/31.4
C2426	4030017330	S.CER C1005 JF 1C 104Z-T	B	68.8/82.2
C2427	4030012600	S.CER C2012 JB 1A 105M-T	T	85.1/91.4
C2501	4030017330	S.CER C1005 JF 1C 104Z-T	B	8.1/94.3
C2502	4030018960	S.CER C3216 JB 1C 106MT-N	B	11.5/95.2
C2503	4030016970	S.CER C1005 JB 1E 223K-T	B	14.9/89.3
C2505	4030016940	S.CER C1005 JB 1A 393K-T	B	17.4/91.4
C2506	4030017780	S.CER C1005 JB 1H 472K-T	B	18.3/93.8
C2507	4030017490	S.CER C1608 JB 1A 105K-T	B	12.8/89.3
C2551	4030017330	S.CER C1005 JF 1C 104Z-T	B	43.0/124.1
C2552	4030018960	S.CER C3216 JB 1C 106MT-N	B	47.9/118.8
C2553	4030016970	S.CER C1005 JB 1E 223K-T	B	51.4/124.7
C2554	4030018390	S.CER C1005 JB 1A 563K-T	B	53.9/122.0
C2555	4030017760	S.CER C1005 JB 1H 222K-T	B	53.9/121.1
C2556	4030017770	S.CER C1005 JB 1H 332K-T	B	52.9/123.8
C2557	4030017330	S.CER C1005 JF 1C 104Z-T	B	41.8/120.9
C2558	4030018960	S.CER C3216 JB 1C 106MT-N	B	43.0/118.5
C2561	4030018960	S.CER C3216 JB 1C 106MT-N	B	56.5/124.4
C2562	4030018960	S.CER C3216 JB 1C 106MT-N	B	53.4/126.5
C2563	4550007970	S.TAN TMCMC1A107MTRF	B	75.3/122.8
C2564	4030018080	S.CER C1005 JB 1H 182K-T	B	47.8/125.6
C2565	4030017430	S.CER C1005 CH 1H 101J-T	B	44.6/122.6
C2566	4030018090	S.CER C1005 JB 1E 822K-T	B	46.2/124.3
C2601	4030017330	S.CER C1005 JF 1C 104Z-T	B	59.8/125.2
C2603	4030010210	S.CER C3216 JB 1C 105M-T	B	87.6/126.1
C2604	4030016970	S.CER C1005 JB 1E 223K-T	B	89.2/128.6
C2605	4030017330	S.CER C1005 JF 1C 104Z-T	B	83.9/133.7
C2606	4510009250	S.ELE EEEFK1C471P	T	69.2/137.4
C2607	4510008650	S.ELE EEEFK1C221P	T	58.5/138.4
C2608	4030017330	S.CER C1005 JF 1C 104Z-T	B	87.6/128.6
C2610	4510009250	S.ELE EEEFK1C471P	T	6.2/65.3
C2612	4030017330	S.CER C1005 JF 1C 104Z-T	B	34.0/123.9
C2613	4510009250	S.ELE EEEFK1C471P	T	31.8/131.5
C2616	4030017780	S.CER C1005 JB 1H 472K-T	T	31.6/134.3
C2617	4030017780	S.CER C1005 JB 1H 472K-T	T	33.5/126.0
C2618	4030017430	S.CER C1005 CH 1H 101J-T	B	61.3/133.4
C2619	4030017780	S.CER C1005 JB 1H 472K-T	T	67.8/112.7
C2620	4510008630	S.ELE 16 CE 47 FE	B	82.9/119.2
C2621	4510008500	S.ELE EEE1CA101WP	T	49.2/138.4
C2622	4510008500	S.ELE EEE1CA101WP	T	62.1/130.4
C2624	4030017330	S.CER C1005 JF 1C 104Z-T	B	38.5/124.5
CP1601	6910009670	S.CHE HK3-S-T	T	11.8/54.7
J1	6510028210	CON SJ050010 (TMP-J01X-V6)		
J101	6510028210	CON SJ050010 (TMP-J01X-V6)		
J401	6510028210	CON SJ050010 (TMP-J01X-V6)		
J801	6510028210</			

[MAIN UNIT]

REF NO.	PARTS NO.	DESCRIPTION	M.	H/V LOCATION
EP511	6910012350	S.BEA MMZ1608Y 102BT	T	44.2/26.5
EP1951	6910014730	S.BEA MPZ2012S331A-T	B	61.4/116.7
EP1952	6910014730	S.BEA MPZ2012S331A-T	B	26.8/113.4
EP1953	6910014730	S.BEA MPZ2012S331A-T	B	10.0/104.5
EP1954	6910014730	S.BEA MPZ2012S331A-T	B	50.4/107.3
EP2001	6910012350	S.BEA MMZ1608Y 102BT	B	74.2/5.3
EP2002	6910012350	S.BEA MMZ1608Y 102BT	B	34.7/12.6
EP2003	6910012350	S.BEA MMZ1608Y 102BT	B	33.5/13.8
EP2004	6910012350	S.BEA MMZ1608Y 102BT	B	39.6/15.9
EP2006	6910014730	S.BEA MPZ2012S331A-T	B	42.2/13.4
EP2007	6910012350	S.BEA MMZ1608Y 102BT	B	45.2/11.1
EP2008	6910012350	S.BEA MMZ1608Y 102BT	B	45.2/14.8
EP2231	6910012350	S.BEA MMZ1608Y 102BT	T	59.9/125.8
EP2251	6910012350	S.BEA MMZ1608Y 102BT	T	4.6/95.5
EP2252	6910012350	S.BEA MMZ1608Y 102BT	T	7.5/95.8
EP2253	6910012350	S.BEA MMZ1608Y 102BT	T	66.1/109.3
EP2254	6910012350	S.BEA MMZ1608Y 102BT	T	65.8/108.1
EP2255	6910012350	S.BEA MMZ1608Y 102BT	T	17.9/101.5
EP2256	6910012350	S.BEA MMZ1608Y 102BT	T	65.1/106.0
EP2257	6910012350	S.BEA MMZ1608Y 102BT	T	65.1/104.8
EP2258	6910012350	S.BEA MMZ1608Y 102BT	B	78.0/93.5
EP2259	6910012350	S.BEA MMZ1608Y 102BT	B	68.1/102.6
EP2260	6910012350	S.BEA MMZ1608Y 102BT	B	68.2/101.4
EP2261	6910012350	S.BEA MMZ1608Y 102BT	B	66.1/98.3
EP2262	6910012350	S.BEA MMZ1608Y 102BT	T	69.9/85.6
EP2263	6910014730	S.BEA MPZ2012S331A-T	T	6.5/93.9
EP2264	6910012350	S.BEA MMZ1608Y 102BT	B	69.4/111.3
EP2265	6910012350	S.BEA MMZ1608Y 102BT	B	68.7/98.3
EP2266	6910012350	S.BEA MMZ1608Y 102BT	T	56.3/93.3
EP2271	6910012350	S.BEA MMZ1608Y 102BT	T	74.6/91.1
EP2402	6910012350	S.BEA MMZ1608Y 102BT	B	51.2/129.6
EP2403	6910012350	S.BEA MMZ1608Y 102BT	B	48.5/129.6
EP2404	6910012350	S.BEA MMZ1608Y 102BT	B	68.6/129.4
EP2405	6910012350	S.BEA MMZ1608Y 102BT	B	62.2/134.9
EP2408	6910012350	S.BEA MMZ1608Y 102BT	B	91.3/102.8
EP2409	6910012350	S.BEA MMZ1608Y 102BT	T	85.3/101.2
EP2410	6910012350	S.BEA MMZ1608Y 102BT	T	84.7/98.4
EP2411	6910012350	S.BEA MMZ1608Y 102BT	T	85.2/79.2
EP2412	6910012350	S.BEA MMZ1608Y 102BT	T	82.6/78.5
EP2413	6910012350	S.BEA MMZ1608Y 102BT	B	72.5/129.3
EP2414	6910012350	S.BEA MMZ1608Y 102BT	B	89.4/91.1
EP2415	6910012350	S.BEA MMZ1608Y 102BT	T	85.0/100.0
EP2416	6910012350	S.BEA MMZ1608Y 102BT	T	80.0/77.6
EP2417	6910012350	S.BEA MMZ1608Y 102BT	B	87.2/78.8
EP2602	6910014730	S.BEA MPZ2012S331A-T	T	36.0/125.7
EP2604	6910014730	S.BEA MPZ2012S331A-T	B	31.6/135.7
EP2605	6910014730	S.BEA MPZ2012S331A-T	T	43.0/135.5
EP2606	6910014730	S.BEA MPZ2012S331A-T	T	41.4/133.7

[PA UNIT]

REF NO.	PARTS NO.	DESCRIPTION	M.	H/V LOCATION
IC471	1110005630	S.IC UPC3215TB-E3-A	B	67.6/96.4
IC701	1180002010	S.REG BA08FP-E2	B	126.3/41.9
IC960	1110002700	S.IC NJM2904M-TE1-#FMZB	B	41.0/132.1
IC981	1130012720	S.IC CD74HC4094PWR	T	26.2/5.9
Q101	1560001091	S.FET 2SK2854(T2LICOMF)	T	149.2/28.5
Q102	1560001241	S.FET RD01MUS1-T113	T	146.0/40.1
Q301	1560001601	FET RD70HHF1C-102		
Q302	1560001601	FET RD70HHF1C-102		
Q401	1560001611	FET RD60HUF1C-101		
Q402	1590000680	S.TRA DTC114EUA T106	B	87.7/132.8
Q403	1590000680	S.TRA DTC114EUA T106	B	90.1/130.4
Q451	1580000691	S.FET 3SK291(TE85RF)	B	76.8/108.4
Q452	1590003940	S.TRA RN1105(TE85LF)	B	67.5/115.8
Q453	1590003940	S.TRA RN1105(TE85LF)	B	75.1/119.9
Q501	1560001591	FET RD70HVF1C-121		
Q502	1590000680	S.TRA DTC114EUA T106	T	87.7/107.5
Q503	1590000680	S.TRA DTC114EUA T106	T	87.7/110.0
Q551	1580000691	S.FET 3SK291(TE85RF)	T	68.4/108.9
Q552	1590003940	S.TRA RN1105(TE85LF)	T	63.0/110.1
Q700	1590003940	S.TRA RN1105(TE85LF)	B	126.5/25.0
Q741	1590003940	S.TRA RN1105(TE85LF)	B	79.4/9.0
Q742	1520000460	S.TRA 2SB1132 T100 R	B	83.7/8.3
Q980	1590003940	S.TRA RN1105(TE85LF)	T	51.3/84.6
Q981	1590003940	S.TRA RN1105(TE85LF)	T	51.5/133.8
Q982	1590003940	S.TRA RN1105(TE85LF)	T	53.8/97.3
Q983	1590003940	S.TRA RN1105(TE85LF)	T	51.3/57.0
Q984	1590003940	S.TRA RN1105(TE85LF)	T	51.6/97.2
Q985	1590003940	S.TRA RN1105(TE85LF)	T	51.3/27.9
Q986	1590003940	S.TRA RN1105(TE85LF)	T	51.3/71.5
Q987	1590003940	S.TRA RN1105(TE85LF)	T	52.5/41.6
Q988	1590003930	S.TRA UMD22N TR	T	58.3/90.3
D101	1750000301	S.DIO 1SS302(TE85RF)	T	152.45/22.7
D102	1750000301	S.DIO 1SS302(TE85RF)	T	152.5/19.9
D151	1750000581	S.DIO 1SV307(TPH3F)	T	59.6/56.4
D152	1790001251	S.DIO MA2S1110GL	T	56.4/58.5
D301	1160000060	S.DIO DAN202U T106	T	105.1/80.8
D302	1160000060	S.DIO DAN202U T106	T	74.9/87.3
D401	1790001241	S.DIO MA2S7280GL	B	128.0/133.6
D402	1790001241	S.DIO MA2S7280GL	B	127.5/139.6
D403	1790001241	S.DIO MA2S7280GL	B	123.5/140.6
D404	1790001241	S.DIO MA2S7280GL	B	125.6/132.8
D406	1710001061	DIO L407CDB		
D407	1710001061	DIO L407CDB		
D408	1750000511	S.DIO UX9401F-STD/TR <INT>	B	97.7/136.4
D409	1750000511	S.DIO UX9401F-STD/TR <INT>	B	103.6/133.1
D410	1750000511	S.DIO UX9401F-STD/TR <INT>	B	104.8/130.1
D411	1790001251	S.DIO MA2S1110GL	B	94.2/129.2
D412	1160000070	S.DIO DAN202K T146	B	91.7/127.1
D451	1750000581	S.DIO 1SV307(TPH3F)	B	85.5/116.4
D452	1750000581	S.DIO 1SV307(TPH3F)	B	82.4/116.0
D453	1720000701	S.VAR 1SV305(TPL3F)	T	75.6/117.3
D454	1720000701	S.VAR 1SV305(TPL3F)	T	77.8/116.6
D455	1720000701	S.VAR 1SV305(TPL3F)	B	75.7/99.2
D456	1720000701	S.VAR 1SV305(TPL3F)	B	67.4/104.2
D461	1750000581	S.DIO 1SV307(TPH3F)	B	65.1/93.6
D462	1750000581	S.DIO 1SV307(TPH3F)	T	65.6/94.7
D501	1790000971	S.DIO MA2J7290GL	B	113.7/123.5
D502	1790000971	S.DIO MA2J7290GL	B	116.4/122.8
D503	1790000971	S.DIO MA2J7290GL	B	114.5/129.5
D504	1790000971	S.DIO MA2J7290GL	B	111.0/129.5
D506	1710001061	DIO L407CDB		
D507	1750000511	S.DIO UX9401F-STD/TR <INT>	B	92.7/117.4
D508	1750000511	S.DIO UX9401F-STD/TR <INT>	T	87.0/114.4
D509	1750000511	S.DIO UX9401F-STD/TR <INT>	T	81.9/120.3
D510	1710001061	DIO L407CDB		
D511	1750000581	S.DIO 1SV307(TPH3F)	B	95.4/112.2
D551	1750000581	S.DIO 1SV307(TPH3F)	T	74.0/116.8
D552	1750000581	S.DIO 1SV307(TPH3F)	T	72.3/116.8
D553	1750000610	S.VAR MA2SV0500L	T	67.2/118.6
D554	1750000610	S.VAR MA2SV0500L	T	69.6/117.9
D555	1750000581	S.DIO 1SV307(TPH3F)	T	66.9/116.7
D556	1720000590	S.VAR MA357(TX)	T	71.6/113.3
D557	1750000581	S.DIO 1SV307(TPH3F)	T	68.1/105.0
D558	1720000590	S.VAR MA357(TX)	T	72.2/104.3
D559	1750000610	S.VAR MA2SV0500L	T	69.0/102.7
D560	1750000610	S.VAR MA2SV0500L	T	71.8/101.3
D701	1790000700	DIO DSA3A1		
D702	1790000700	DIO DSA3A1		
D703	1160000070	S.DIO DAN202K T146	B	126.5/21.5
D704	1790001241	S.DIO MA2S7280GL	B	87.9/114.0
D705	1160000070	S.DIO DAN202K T146	B	137.5/14.3
D706	1790001241	S.DIO MA2S7280GL	B	86.0/113.1
D801	1750000301	S.DIO 1SS302(TE85RF)	B	42.7/41.8
D820	1750000301	S.DIO 1SS302(TE85RF)	B	54.4/94.6
D840	1750000301	S.DIO 1SS302(TE85RF)	B	43.4/99.8
D860	1750000301	S.DIO 1SS302(TE85RF)	B	43.0/86.0
D880	1750000301	S.DIO 1SS302(TE85RF)	B	43.3/71.7
D900	1750000301	S.DIO 1SS302(TE85RF)	B	43.7/56.9
D920	1750000301	S.DIO 1SS302(TE85RF)	B	43.0/28.1
D940	1750000301	S.DIO 1SS302(TE85RF)	B	41.1/14.3
D961	1790000491	S.DIO HSM88ASTR-E	B	28.2/130.2
D962	1790000491	S.DIO HSM88ASTR-E	B	28.2/133.8
D964	1750000511	S.DIO UX9401F-STD/TR <INT>	B	40.1/43.9
D965	1750000511	S.DIO UX9401F-STD/TR <INT>	B	42.8/48.0

M.=Mounted side (T: Mounted on the Top side, B: Mounted on the Bottom side)
S.=Surface mount

[PA UNIT]

REF NO.	PARTS NO.	DESCRIPTION	M.	H/V LOCATION
L101	6200005051	S.COI NLV25T-330J	T	151.3/33.6
L102	6200008570	S.COI LQW2BHN6N8D03L	T	152.3/37.3
L103	6180000990	COI LAL 04NA 101K		
L104	6180000990	COI LAL 04NA 101K		
L105	6200003950	S.COI HF50ACC 322513-T	B	135.7/34.1
L107	6200002631	S.COI NLV25T-R10J	T	141.0/47.9
L108	6200003031	S.COI NLV32T-R47J	B	138.1/41.8
L151	6200003941	S.COI NLV25T-5R6J	B	64.2/41.0
L152	6200005521	S.COI NLV25T-470J	B	64.8/38.1
L201	6140004580	S.COI LR-515	T	150.4/52.5
L203	6200010040	S.COI AS100340-10N	T	113.8/79.5
L204	6200010040	S.COI AS100340-10N	T	123.5/69.7
L301	6140003410	COI LR-383		
L302	2040000490	COI EXC-ELDR25C		
L303	6140003590	COI LR-400 (TR10X5X5 6H3)		
L304	6140004570	COI LR-507		
L305	6140004560	COI LR-506		
L404	6200010060	S.COI AS080647-56N	T	141.1/109.0
L407	6200010170	S.COI AS080447-33N	T	146.6/110.8
L408	2040000490	COI EXC-ELDR25C		
L409	2040000490	COI EXC-ELDR25C		
L410	6200010040	S.COI AS100340-10N	T	126.6/137.8
L411	6200010420	S.COI FHW1210HC 1R0JGT <JJE>	T	118.3/136.7
L412	6200010160	S.COI AS080440-22N	T	104.5/134.4
L413	6200010150	S.COI AS080340-15N	T	88.3/139.6
L414	6200010150	S.COI AS080340-15N	T	81.0/133.6
L415	6200012960	S.COI 0.45-1.4-4TL 12.1N <COMO>	T	99.2/134.0
L416	6200013000	S.COI 0.25-1.9-13TL 135N <COMO>	T	93.8/132.1
L417	6200007790	S.COI LQW2BHN1R15J03L	B	98.3/131.1
L441	6200010040	S.COI AS100340-10N	T	133.4/137.8
L451	6200005621	S.COI ELJRE 4N7ZFA	B	81.5/120.1
L452	6200012660	S.COI 0.30-1.0-4TR 9.1N <COMO>	T	76.7/114.9
L453	6200007230	S.COI LQW2BHN15N03L	B	74.1/104.1
L454	6200007230	S.COI LQW2BHN15N03L	B	70.0/102.4
L501	6200010780	S.COI C2520C-1R0G-A	T	117.1/86.6
L502	6200010060	S.COI AS080647-56N	T	118.1/125.0
L504	6200010780	S.COI C2520C-1R0G-A	T	105.8/123.5
L505	6200010070	S.COI AS080747-68N	T	90.2/118.6
L506	6200010170	S.COI AS080447-33N	T	92.0/124.3
L507	6200012910	S.COI 0.35-1.6-8TL 45.5N <COMO>	T	84.7/118.0
L508	6200010050	S.COI AS080547-47N	T	81.9/127.7
L509	6200010780	S.COI C2520C-1R0G-A	T	93.2/113.2
L510	6200010050	S.COI AS080547-47N	T	75.5/127.5
L531	6110003980	COI LA-604		
L541	6200010070	S.COI AS080747-68N	T	128.6/129.9
L551	6200007700	S.COI LQW2BHN22N03L	T	76.1/120.8
L552	6200007720	S.COI LQW2BHN33N03L	T	70.9/121.3
L553	6200008090	S.COI LQW2BHN68N03L	T	65.2/121.7
L554	6200003640	S.COI MLF1608E 100K-T	T	64.9/114.8
L555	6200003711	S.COI NLV25T-2R7J	B	65.2/105.4
L556	6200003640	S.COI MLF1608E 100K-T	B	65.0/109.6
L557	6200007760	S.COI LQW2BHN82N03L	T	66.8/100.5
L558	6200007710	S.COI LQW2BHN27N03L	T	69.9/98.4
L560	6200002611	S.COI NLV25T-R47J	T	62.9/97.3
L601	6200010040	S.COI AS100340-10N	T	69.3/127.6
L602	6200010160	S.COI AS080440-22N	T	65.7/132.8
L603	6200010150	S.COI AS080340-15N	T	60.9/133.6
L705	6200003550	S.COI MLF1608A 4R7K-T	B	68.2/10.3
L706	6200011300	S.COI EXCML16A270U	T	91.0/6.9
L707	6200011300	S.COI EXCML16A270U	T	91.0/6.6
L801	6200011410	S.COI C2520C-82NG-A	T	55.8/55.5
L802	6200010650	S.COI C2520C-R12G-A (0.12U)	T	58.5/52.1
L803	6200007420	S.COI ELJFC 101K-F	B	50.5/39.8
L820	6200006430	S.COI ELJFC 180K-F	B	52.9/97.4
L821	6140002020	COI LR-229 (T50-10)		
L822	6140003540	COI LR-396		
L823	6200006430	S.COI ELJFC 180K-F	B	2.8/106.8
L840	6200007420	S.COI ELJFC 101K-F	B	49.3/98.5
L841	6140001820	COI LR-218 (T50-10)		
L842	6140001800	COI LR-216 (T50-2)		
L843	6140001800	COI LR-216 (T50-2)		
L844	6200007420	S.COI ELJFC 101K-F	B	2.6/90.7
L860	6200004440	S.COI ELJFC 4R7M-F	B	50.3/83.8
L861	6110003550	COI LA-547 (LA-214A)		
L862	6110003570	COI LA-550		
L863	6110003540	COI LA-548 (LA-215A)		
L864	6200004440	S.COI ELJFC 4R7M-F	B	2.8/74.5
L880	6200007420	S.COI ELJFC 101K-F	B	50.4/69.1
L881	6140002570	COI LR-294 (T50-2)		
L882	6140002580	COI LR-295 (T50-2)		
L883	6200007420	S.COI ELJFC 101K-F	B	2.6/58.4
L900	6200008600	S.COI ELJFC 560K-F	B	50.0/54.6
L901	6140002560	COI LR-293 (T50-10)		
L902	6140002560	COI LR-293 (T50-10)		
L903	6140002560	COI LR-293 (T50-10)		
L904	6200008600	S.COI ELJFC 560K-F	B	2.6/42.3
L920	6200007420	S.COI ELJFC 101K-F	B	50.4/25.4
L921	6140001780	COI LR-214 (T50-2)		
L922	6140001780	COI LR-214 (T50-2)		
L923	6200007420	S.COI ELJFC 101K-F	B	2.6/26.1
L940	6200007390	S.COI ELJFC 120K-F	B	47.3/9.9
L941	6140003450	COI LR-387 (T50-10)		
L942	6140003460	COI LR-388 (T50-10)		
L943	6200007420	S.COI ELJFC 101K-F	B	41.1/11.1
L944	6200007390	S.COI ELJFC 120K-F	B	9.0/10.5
L960	6200007420	S.COI ELJFC 101K-F	B	45.3/130.6
L961	6140003490	COI LR-391 (TR10X5X5 3A6)		
L980	6200007420	S.COI ELJFC 101K-F	B	30.8/8.1

[PA UNIT]

REF NO.	PARTS NO.	DESCRIPTION	M.	H/V LOCATION
L981	6200007420	S.COI ELJFC 101K-F	T	51.7/9.0
L982	6200007420	S.COI ELJFC 101K-F	T	48.4/2.3
R101	7030003370	S.RES ERJ3GEYJ 271 V (270)	B	150.9/21.0
R102	7030003230	S.RES ERJ3GEYJ 180 V (18)	B	150.9/22.5
R103	7030003370	S.RES ERJ3GEYJ 271 V (270)	B	151.9/25.2
R104	7030003300	S.RES ERJ3GEYJ 680 V (68)	B	150.8/27.7
R105	7030003420	S.RES ERJ3GEYJ 681 V (680)	T	152.7/29.8
R106	7030003480	S.RES ERJ3GEYJ 222 V (2.2K)	B	147.8/29.7
R107	7030003530	S.RES ERJ3GEYJ 562 V (5.6K)	B	147.8/28.3
R108	7030003400	S.RES ERJ3GEYJ 471 V (470)	T	151.4/31.7
R109	7030008190	S.RES ERJ12YJ330U (33)	B	145.5/32.7
R110	7030000230	S.RES MCR10EZJH 56 (560)	T	149.4/39.8
R111	7030003410	S.RES ERJ3GEYJ 561 V (560)	B	143.8/42.1
R112	7030003510	S.RES ERJ3GEYJ 392 V (3.9K)	B	146.1/37.5
R113	7030003540	S.RES ERJ3GEYJ 682 V (6.8K)	B	146.1/35.7
R116	7030000340	S.RES MCR10EZJH 470 (471)	B	141.4/40.9
R117	7030003860	S.RES ERJ3GE JPW V	T	146.7/47.7
R151	7030003380	S.RES ERJ3GEYJ 331 V (330)	B	61.6/37.8
R152	7030003440	S.RES ERJ3GEYJ 102 V (1K)	B	61.8/60.1
R153	7030003520	S.RES ERJ3GEYJ 472 V (4.7K)	T	59.2/58.0
R201	7030003320	S.RES ERJ3GEYJ 101 V (100)	B	123.0/49.9
R202	7030003520	S.RES ERJ3GEYJ 472 V (4.7K)	B	136.0/49.9
R204	7030003440	S.RES ERJ3GEYJ 102 V (1K)	B	138.0/52.8
R205	7030010420	S.RES ERJ1TYJ 560U (56)	B	145.0/51.5
R301	7030009300	S.RES ERJ1WY0R00U	B	92.2/84.4
R302	7030010520	S.RES ERJ1TYJ 101U (100)	T	89.4/86.1
R303	7030009300	S.RES ERJ1WY0R00U	B	85.4/84.4
R304	7030003320	S.RES ERJ3GEYJ 101 V (100)	T	107.1/79.8
R305	7030010410	S.RES ERJ1TYJ 220U (22)	T	100.2/84.1
R306	7030003320	S.RES ERJ3GEYJ 101 V (100)	B	71.3/83.3
R307	7030010410	S.RES ERJ1TYJ 220U (22)	T	77.5/84.1
R308	7030003480	S.RES ERJ3GEYJ 222 V (2.2K)	B	99.1/85.0
R309	7030003480	S.RES ERJ3GEYJ 222 V (2.2K)	B	78.8/85.0
R310	7030007630	S.RES MCR100ZJH 0.68 (R68)	B	100.1/82.2
R311	7030007630	S.RES MCR100ZJH 0.68 (R68)	B	78.8/82.1
R312	7030011250	S.RES ERJ1TY 390U (39)	T	100.9/77.7
R313	7030010540	S.RES ERJ1TYJ 330U (33)	T	97.2/77.7
R314	7030010540	S.RES ERJ1TYJ 330U (33)	T	81.6/77.7
R315	7030011250	S.RES ERJ1TY 390U (39)	T	77.9/77.7
R317	7030010950	S.RES ERJ1TYJ 100U (10)	B	104.0/20.6
R318	7030010950	S.RES ERJ1TYJ 100U (10)	B	99.6/20.6
R319	7030010660	S.RES ERJ1TYJ 6R8U (6.8)	B	89.4/54.6
R402	7030003320	S.RES ERJ3GEYJ 101 V (100)	B	151.7/73.2
R403	7030003520	S.RES ERJ3GEYJ 472 V (4.7K)	T	151.8/71.3
R404	7030000260	S.RES MCR10EZJH 100 (101)	T	149.5/76.0
R405	7030003540	S.RES ERJ3GEYJ 682 V (6.8K)	B	126.8/137.6
R406	7030003860	S.RES ERJ3GE JPW V	B	128.4/136.1
R407	7030003440	S.RES ERJ3GEYJ 102 V (1K)	B	129.7/133.6
R408	7030003860	S.RES ERJ3GE JPW V	B	124.1/137.6
R409	7030003440	S.RES ERJ3GEYJ 102 V (1K)	B	127.1/130.4
R410	7030003440	S.RES ERJ3GEYJ 102 V (1K)	B	131.6/133.0
R411	7030003540	S.RES ERJ3GEYJ 682 V (6.8K)	B	125.2/135.5
R412	7030003500	S.RES ERJ3GEYJ 332 V (3.3K)	B	131.1/129.7
R413	7030007160	S.RES ERJ12YJ3R3U (3.3)	B	123.6/125.2
R415	7030008350	S.RES ERJ12YJ390U	B	86.8/136.5
R416	7030000140	S.RES MCR10EZJH 10 (100)	B	96.8/130.8
R417	7030000140	S.RES MCR10EZJH 10 (100)	B	95.6/132.5
R418	7030000010	S.RES MCR10EZJH JPW (000)	B	99.4/133.9
R451	7030003470	S.RES ERJ3GEYJ 182 V (1.8K)	B	81.5/121.7
R452	7030004040	S.RES ERJ3GEYJ 4R7 V (4.7)	B	85.5/119.3
R453	7030003260	S.RES ERJ3GEYJ 330 V (33)	B	81.6/118.4
R454	7030003860	S.RES ERJ3GE JPW V	B	77.3/116.0
R455	7030003640	S.RES ERJ3GEYJ 473 V (47K)	B	73.2/117.5
R456	7030003700	S.RES ERJ3GEYJ 154 V (150K)	B	72.0/114.5
R457	7030003750	S.RES ERJ3GEYJ 394 V (390K)	B	71.2/111.9
R458	7030003710	S.RES ERJ3GEYJ 184 V (180K)	B	73.9/112.5
R459	7030003740	S.RES ERJ3GEYJ 334 V (330K)	B	69.6/111.3
R460	7030003740	S.RES ERJ3GEYJ 334 V (330K)	B	76.7/112.1
R461	7030003270	S.RES ERJ3GEYJ 390 V (39)	B	77.7/103.4
R462	7030003680	S.RES ERJ3GEYJ 104 V (100K)	B	72.9/99.6
R463	7030003520	S.RES ERJ3GEYJ 472 V (4.7K)	B	74.4/102.4
R464	7030003210	S.RES ERJ3GEYJ 120 V (12)	B	74.1/105.7
R465	7030003680	S.RES ERJ3GEYJ 104 V (100K)	B	66.6/101.8
R466	7030003860	S.RES ERJ3GE JPW V	B	62.2/100.2
R467	7030003640	S.RES ERJ3GEYJ 473 V (47K)	B	75.1/117.2
R468	7030008240	S.RES ERJ12Y0R00U	B	89.2/122.0
R470	7030003320	S.RES ERJ3GEYJ 101 V (100)	B	67.8/98.9
R471	7030003270	S.RES ERJ3GEYJ 390 V (39)	B	69.7/98.3
R472	7030003340	S.RES ERJ3GEYJ 151 V (150)	B	69.7/99.5
R473	7030003340	S.RES ERJ3GEYJ 151 V (150)	B	69.7/100.7
R474	7030003340	S.RES ERJ3GEYJ 151 V (150)	B	63.5/97.0
R475	7030003340	S.RES ERJ3GEYJ 151 V (150)	B	65.0/97.0
R476	7030003270	S.RES ERJ3GEYJ 390 V (39)	B	64.9/95.1
R477	7030003360	S.RES ERJ3GEYJ 221 V (220)	B	61.8/97.6
R502	7030003320	S.RES ERJ3GEYJ 101 V (100)	T	112.1/87.9
R503	7030003520	S.RES ERJ3GEYJ 472 V (4.7K)	T	112.6/86.0
R504	7030000260	S.RES MCR10EZJH 100 (101)	T	114.2/86.2
R505	7030003540	S.RES ERJ3GEYJ 682 V (6.8K)	B	120.0/124.8

[PA UNIT]

REF NO.	PARTS NO.	DESCRIPTION	M.	H/V LOCATION
R517	7030010520	S.RES ERJ1TYJ 101U (100)	B	103.7/118.4
R518	7030003440	S.RES ERJ3GEYJ 102 V (1K)	B	97.5/112.7
R519	7030000010	S.RES MCR10EZHJ JPW (000)	B	111.2/119.1
R551	7030003470	S.RES ERJ3GEYJ 182 V (1.8K)	T	78.2/117.8
R552	7030004040	S.RES ERJ3GEYJ 4R7 V (4.7)	T	76.7/119.1
R553	7030003260	S.RES ERJ3GEYJ 330 V (33)	T	73.1/119.0
R554	7030003680	S.RES ERJ3GEYJ 104 V (100K)	T	66.8/120.5
R555	7030003440	S.RES ERJ3GEYJ 102 V (1K)	T	68.1/114.7
R556	7030003680	S.RES ERJ3GEYJ 104 V (100K)	T	70.0/116.7
R557	7030003740	S.RES ERJ3GEYJ 334 V (330K)	T	65.7/112.9
R558	7030003710	S.RES ERJ3GEYJ 184 V (180K)	T	70.5/111.2
R559	7030003720	S.RES ERJ3GEYJ 224 V (220K)	T	65.7/111.7
R560	7030003720	S.RES ERJ3GEYJ 224 V (220K)	T	65.6/110.5
R561	7030003740	S.RES ERJ3GEYJ 334 V (330K)	T	68.3/112.4
R562	7030003270	S.RES ERJ3GEYJ 390 V (39)	T	70.1/106.6
R563	7030003420	S.RES ERJ3GEYJ 681 V (680)	T	65.4/107.3
R564	7030003210	S.RES ERJ3GEYJ 120 V (12)	T	63.5/103.0
R565	7030003440	S.RES ERJ3GEYJ 102 V (1K)	B	65.7/106.4
R567	7030003680	S.RES ERJ3GEYJ 104 V (100K)	T	70.1/104.0
R568	7030003680	S.RES ERJ3GEYJ 104 V (100K)	T	69.8/100.8
R570	7030003380	S.RES ERJ3GEYJ 331 V (330)	T	62.8/100.3
R575	7030003520	S.RES ERJ3GEYJ 472 V (4.7K)	T	68.5/100.8
R576	7030003540	S.RES ERJ3GEYJ 682 V (6.8K)	T	71.8/100.0
R577	7030003520	S.RES ERJ3GEYJ 472 V (4.7K)	T	68.0/120.5
R578	7030003540	S.RES ERJ3GEYJ 682 V (6.8K)	T	70.0/119.1
R701	7030003500	S.RES ERJ3GEYJ 332 V (3.3K)	B	82.2/16.9
R702	7030003500	S.RES ERJ3GEYJ 332 V (3.3K)	B	83.1/14.6
R703	7030003500	S.RES ERJ3GEYJ 332 V (3.3K)	B	80.6/16.9
R704	7030003500	S.RES ERJ3GEYJ 332 V (3.3K)	B	79.8/14.6
R705	7030009300	S.RES ERJ1WY0R00U	B	134.7/23.9
R721	7030011240	S.RES LRF3W-LF-01-R020F	B	83.0/22.3
R722	7030011240	S.RES LRF3W-LF-01-R020F	B	83.0/29.6
R723	7030004040	S.RES ERJ3GEYJ 4R7 V (4.7)	B	140.6/14.7
R733	7030009591	S.RES ERA3YED 472V (4.7K)	B	138.6/10.4
R734	7510001470	S.THE NTCG20 4AG 473JT	T	111.9/58.2
R735	7030009591	S.RES ERA3YED 472V (4.7K)	B	140.2/12.5
R736	7510001470	S.THE NTCG20 4AG 473JT	T	153.4/77.2
R742	7030003640	S.RES ERJ3GEYJ 473 V (47K)	B	83.4/11.5
R743	7030003440	S.RES ERJ3GEYJ 102 V (1K)	B	80.2/11.0
R744	7030003860	S.RES ERJ3GE JPW V	T	67.8/9.6
R749	7030003860	S.RES ERJ3GE JPW V	B	65.0/5.3
R750	7030003860	S.RES ERJ3GE JPW V	B	66.7/5.3
R773	7030003860	S.RES ERJ3GE JPW V	T	103.4/9.6
R960	7030003860	S.RES ERJ3GE JPW V	B	43.2/125.7
R961	7030003380	S.RES ERJ3GEYJ 331 V (330)	B	42.0/138.3
R962	7030003440	S.RES ERJ3GEYJ 102 V (1K)	B	37.4/137.9
R963	7030003440	S.RES ERJ3GEYJ 102 V (1K)	B	40.3/126.3
R964	7030003860	S.RES ERJ3GE JPW V	B	24.8/131.2
R965	7030003640	S.RES ERJ3GEYJ 473 V (47K)	B	32.6/130.6
R966	7030008190	S.RES ERJ12YJ330U (33)	B	11.1/129.6
R967	7030003640	S.RES ERJ3GEYJ 473 V (47K)	B	34.2/130.6
R968	7030003860	S.RES ERJ3GE JPW V	B	24.8/132.8
R969	7030003600	S.RES ERJ3GEYJ 223 V (22K)	B	32.6/133.7
R970	7030003680	S.RES ERJ3GEYJ 104 V (100K)	B	34.2/133.7
R971	7540000130	ABS 2P-50A-301		
R972	7030003620	S.RES ERJ3GEYJ 333 V (33K)	B	17.4/140.1
R973	7030003620	S.RES ERJ3GEYJ 333 V (33K)	B	18.9/138.5
R974	7030003620	S.RES ERJ3GEYJ 333 V (33K)	B	19.4/136.6
R994	7030003560	S.RES ERJ3GEYJ 103 V (10K)	B	22.4/2.6
R995	7030003560	S.RES ERJ3GEYJ 103 V (10K)	B	22.4/6.8
R996	7030003560	S.RES ERJ3GEYJ 103 V (10K)	B	21.6/5.4
R997	7030003560	S.RES ERJ3GEYJ 103 V (10K)	B	21.6/8.2
R998	7030003320	S.RES ERJ3GEYJ 101 V (100)	T	54.1/4.4
R999	7030003320	S.RES ERJ3GEYJ 101 V (100)	T	54.5/3.1
R1000	7030003320	S.RES ERJ3GEYJ 101 V (100)	T	51.2/3.5
R1001	7030003320	S.RES ERJ3GEYJ 101 V (100)	T	49.4/4.9
R1002	7030000280	S.RES MCR10EZHJ 150 (151)	T	48.0/9.7
R1003	7030000290	S.RES MCR10EZHJ 180 (181)	T	47.5/7.9
C101	4030011600	S.CER C1608 JB 1E 104K-T	T	152.0/25.2
C102	4030011600	S.CER C1608 JB 1E 104K-T	B	150.8/29.3
C103	4030011340	S.CER C1608 CH 1H 471J-T	T	152.7/27.2
C104	4030011600	S.CER C1608 JB 1E 104K-T	T	147.8/32.2
C105	4510004591	ELE 16 ME 470 HC		
C106	4030011600	S.CER C1608 JB 1E 104K-T	B	142.7/29.2
C107	4030011600	S.CER C1608 JB 1E 104K-T	T	151.6/39.7
C108	4030011600	S.CER C1608 JB 1E 104K-T	T	149.2/36.5
C109	4030007130	S.CER C1608 CH 1H 101J-T	B	146.6/42.1
C112	4030011600	S.CER C1608 JB 1E 104K-T	B	139.2/35.1
C113	4030011600	S.CER C1608 JB 1E 104K-T	T	144.6/44.4
C114	4030011600	S.CER C1608 JB 1E 104K-T	B	134.1/37.0
C116	4030007090	S.CER C1608 CH 1H 470J-T	T	144.6/45.8
C118	4030007130	S.CER C1608 CH 1H 101J-T	T	143.5/48.5
C119	4030007130	S.CER C1608 CH 1H 101J-T	T	144.0/50.4
C120	4030007020	S.CER C1608 CH 1H 120J-T	T	143.5/47.2
C122	4510008500	S.ELE EEE1CA101WP	T	121.5/11.2
C151	4030011600	S.CER C1608 JB 1E 104K-T	T	59.2/54.9
C152	4030006880	S.CER C1608 JB 1H 472K-T	B	61.6/36.2
C153	4030011600	S.CER C1608 JB 1E 104K-T	B	63.1/56.0
C154	4030006860	S.CER C1608 JB 1H 102K-T	B	63.1/54.7
C201	4030006860	S.CER C1608 JB 1H 102K-T	T	145.6/53.1
C202	4030006860	S.CER C1608 JB 1H 102K-T	T	143.0/53.1
C204	4030011600	S.CER C1608 JB 1E 104K-T	B	139.3/48.4
C205	4030006860	S.CER C1608 JB 1H 102K-T	B	123.3/48.6
C206	4030017810	S.CER C1608 CH 1H 102J-T	B	133.5/50.6
C207	4030017810	S.CER C1608 CH 1H 102J-T	B	139.3/49.7
C208	4030011600	S.CER C1608 JB 1E 104K-T	B	132.0/50.6

[PA UNIT]

REF NO.	PARTS NO.	DESCRIPTION	M.	H/V LOCATION
C209	4030007170	S.CER C1608 CH 1H 221J-T	B	139.3/51.0
C211	4030011160	S.CER GRM31M2C2H150JV01L (GRM42-6 CH)	B	139.3/55.3
C214	4030018940	S.CER GRM31A7U2J331JW31D	T	116.3/76.1
C215	4030018930	S.CER GRM31A7U2J221JW31D	T	122.2/73.9
C217	4030011600	S.CER C1608 JB 1E 104K-T	T	144.3/53.1
C218	4030018930	S.CER GRM31A7U2J221JW31D	T	101.0/88.5
C219	4030018930	S.CER GRM31A7U2J221JW31D	B	82.4/99.7
C251	4030011180	S.CER GRM31M2C2H220JV01L (GRM42-6 CH)	B	134.9/66.0
C252	4030011180	S.CER GRM31M2C2H220JV01L (GRM42-6 CH)	B	142.2/70.6
C253	4030011080	S.CER GRM31M2C2H6R0DV01L (GRM42-6 CH)	B	145.5/79.0
C254	4030011160	S.CER GRM31M2C2H150JV01L (GRM42-6 CH)	B	127.8/65.3
C261	4030012480	S.CER GRM31M2C2H121JV01L (GRM42-6 CH)	B	131.8/75.1
C262	4030018940	S.CER GRM31A7U2J331JW31D	B	126.0/80.1
C263	4030018770	S.CER C3216 CH 2J 102J-T	B	122.1/80.7
C266	4030018950	S.CER GRM31A7U2J681JW31D	B	119.7/80.2
C267	4030018930	S.CER GRM31A7U2J221JW31D	B	124.1/85.3
C301	4030001100	S.CER GRM216B11H102KA01D (GRM40 B)	B	91.8/100.6
C302	4030001020	S.CER GRM216C21H121JA01D (GRM40 CH)	B	93.9/100.6
C303	4030011600	S.CER C1608 JB 1E 104K-T	B	110.8/85.5
C304	4030017320	S.CER GRM21BB11H104KA01L (GRM40-034)	B	94.8/97.6
C305	4510004591	ELE 16 ME 470 HC		
C306	4030004720	S.CER C2012 JB 1H 102K-T	[EUR]	83.6/39.9
	4030004720	S.CER C2012 JB 1H 102K-T	[FRA]	
	4030004720	S.CER C2012 JB 1H 102K-T	[ESP]	
	4030004720	S.CER C2012 JB 1H 102K-T	[USA]	
	4030004720	S.CER C2012 JB 1H 102K-T	[EXP]	
	4030004720	S.CER C2012 JB 1H 102K-T	[ITR]	
	4030004720	S.CER C2012 JB 1H 102K-T	[UK]	
	4030004720	S.CER C2012 JB 1H 102K-T	[KOR]	
	4030006860	S.CER C1608 JB 1H 102K-T	[AUS]	
C307	4030004720	S.CER C2012 JB 1H 102K-T	[CHN]	100.7/39.9
	4030004720	S.CER C2012 JB 1H 102K-T	[EUR]	
	4030004720	S.CER C2012 JB 1H 102K-T	[ESP]	
	4030004720	S.CER C2012 JB 1H 102K-T	[USA]	
	4030004720	S.CER C2012 JB 1H 102K-T	[EXP]	
	4030004720	S.CER C2012 JB 1H 102K-T	[ITR]	
	4030004720	S.CER C2012 JB 1H 102K-T	[UK]	
	4030006860	S.CER C1608 JB 1H 102K-T	[AUS]	
C308	4030004720	S.CER C2012 JB 1H 102K-T	[CHN]	92.0/11.0
	4030004720	S.CER C2012 JB 1H 102K-T	[EUR]	
	4030004720	S.CER C2012 JB 1H 102K-T	[FRA]	
	4030004720	S.CER C2012 JB 1H 102K-T	[ESP]	
	4030004720	S.CER C2012 JB 1H 102K-T	[USA]	
	4030004720	S.CER C2012 JB 1H 102K-T	[EXP]	
	4030004720	S.CER C2012 JB 1H 102K-T	[ITR]	
	4030004720	S.CER C2012 JB 1H 102K-T	[UK]	
	4030004720	S.CER C2012 JB 1H 102K-T	[KOR]	
	4030006860	S.CER C1608 JB 1H 102K-T	[AUS]	
	4030004720	S.CER C2012 JB 1H 102K-T	[CHN]	
C309	4030011600	S.CER C1608 JB 1E 104K-T	T	105.8/78.3
C311	4030018750	S.CER C3225 CH 2J 682K-T	B	92.7/78.5
C312	4030018750	S.CER C3225 CH 2J 682K-T	B	86.1/78.5
C313	4030011600	S.CER C1608 JB 1E 104K-T	T	76.8/87.8
C314	4030018750	S.CER C3225 CH 2J 682K-T	B	96.9/77.6
C315	4030018750	S.CER C3225 CH 2J 682K-T	B	81.9/77.6
C319	4030011730	S.CER GRM31M2C2H101JV01L (GRM42-6 CH)	B	110.0/48.8
C320	4030011730	S.CER GRM31M2C2H101JV01L (GRM42-6 CH)	B	71.1/48.9
C323	4030003810	S.MIC UC342H 1200J-T	T	91.5/46.4
C324	4320001050	S.MIC UC342H 3900J-T	T	94.4/40.2
C325	4320001070	S.MIC UC342H 3300J-T	B	94.4/40.7
C327	4030011790	S.CER GRM55RF52A684ZD01L (GRM44-1)	T	65.9/46.3
C331	4030011600	S.CER C1608 JB 1E 104K-T	T	108.3/78.3
C332	4030011600	S.CER C1608 JB 1E 104K-T	B	69.5/81.4
C333	4030018940	S.CER GRM31A7U2J331JW31D	B	88.4/101.8
C340	4030006860	S.CER C1608 JB 1H 102K-T	B	82.3/107.4
C341	4030006860	S.CER C1608 JB 1H 102K-T	B	92.5/107.4
C342	4030006860	S.CER C1608 JB 1H 102K-T	B	87.2/91.7
C350	4030004720	S.CER C2012 JB 1H 102K-T	[EUR]	103.4/39.9
	4030004720	S.CER C2012 JB 1H 102K-T	[FRA]	
	4030004720	S.CER C2012 JB 1H 102K-T	[ESP]	
	4030004720	S.CER C2012 JB 1H 102K-T	[USA]	
	4030004720	S.CER C2012 JB 1H 102K-T	[EXP]	
	4030004720	S.CER C2012 JB 1H 102K-T	[ITR]	
	4030004720	S.CER C2012 JB 1H 102K-T	[UK]	
	4030004720	S.CER C2012 JB 1H 102K-T	[KOR]	
	4030004720	S.CER C2012 JB 1H 102K-T	[CHN]	

M.=Mounted side (T: Mounted on the Top side, B: Mounted on the Bottom side)
S.=Surface mount

[PA UNIT]

REF NO.	PARTS NO.	DESCRIPTION	M.	H/V LOCATION
C536	4030017980	S.CER ERF22X 6C2H 470J D01L	T	101.0/110.8
C537	4030017940	S.CER ERF22X 6C2H 680J D01L	T	101.0/114.2
C538	4030017880	S.CER ERF22X 6C2H 560J D01L (GRM111)	T	131.2/117.6
C541	4030011060	S.CER GRM31M2C2H4R0CY21L (GRM42-6 CH)	T	125.1/123.8
C542	4030012480	S.CER GRM31M2C2H121JV01L (GRM42-6 CH)	T	123.4/128.8
C544	4030011730	S.CER GRM31M2C2H101JV01L (GRM42-6 CH)	T	129.9/123.5
C545	4030017940	S.CER ERF22X 6C2H 680J D01L	B	112.7/109.9
C551	4030006880	S.CER C1608 JB 1H 472K-T	T	80.1/117.1
C552	4030006860	S.CER C1608 JB 1H 102K-T	T	73.1/120.5
C553	4030006850	S.CER C1608 JB 1H 471K-T	T	69.4/114.8
C554	4030006860	S.CER C1608 JB 1H 102K-T	T	66.8/114.8
C555	4030006860	S.CER C1608 JB 1H 102K-T	T	63.1/111.7
C556	4030011600	S.CER C1608 JB 1E 104K-T	T	68.3/111.2
C557	4030006860	S.CER C1608 JB 1H 102K-T	T	70.8/108.5
C558	4030006860	S.CER C1608 JB 1H 102K-T	T	65.4/108.6
C559	4030006860	S.CER C1608 JB 1H 102K-T	T	66.1/103.5
C560	4030006860	S.CER C1608 JB 1H 102K-T	B	65.3/113.0
C561	4030006850	S.CER C1608 JB 1H 471K-T	T	70.1/105.3
C562	4030006860	S.CER C1608 JB 1H 102K-T	T	69.2/94.9
C563	4030006860	S.CER C1608 JB 1H 102K-T	T	62.3/106.1
C564	4030006860	S.CER C1608 JB 1H 102K-T	T	65.0/97.0
C565	4030006860	S.CER C1608 JB 1H 102K-T	T	62.3/103.0
C567	4030006860	S.CER C1608 JB 1H 102K-T	T	69.2/120.9
C601	4030011070	S.CER GRM31M2C2H5R0CY21L (GRM42-6 CH)	T	69.5/132.7
C602	4030011090	S.CER GRM31M2C2H7R0DV01L (GRM42-6 CH)	T	67.0/136.8
C701	4030017320	S.CER GRM21BB11H104KA01L (GRM40-034)	B	109.8/33.4
C702	4030006860	S.CER C1608 JB 1H 102K-T	B	107.7/33.2
C703	4030011600	S.CER C1608 JB 1E 104K-T	B	83.8/16.9
C704	4510004601	ELE 16 ME 1000 HC		
C705	4030011600	S.CER C1608 JB 1E 104K-T	B	79.0/16.9
C706	4510004601	ELE 16 ME 1000 HC		
C707	4030017320	S.CER GRM21BB11H104KA01L (GRM40-034)	B	67.1/18.6
C708	4030006900	S.CER C1608 JB 1H 103K-T	T	63.3/27.9
C709	4030006860	S.CER C1608 JB 1H 102K-T	T	63.3/26.6
C710	4030006850	S.CER C1608 JB 1H 471K-T	T	63.3/25.3
C711	4030007170	S.CER C1608 CH 1H 221J-T	T	63.3/24.0
C712	4030007170	S.CER C1608 CH 1H 221J-T	B	70.5/18.7
C713	4510004591	ELE 16 ME 470 HC		
C715	4030006860	S.CER C1608 JB 1H 102K-T	B	97.1/118.9
C718	4030011600	S.CER C1608 JB 1E 104K-T	B	128.4/19.3
C719	4030011600	S.CER C1608 JB 1E 104K-T	T	125.9/16.5
C720	4030011600	S.CER C1608 JB 1E 104K-T	B	130.6/38.8
C722	4030007130	S.CER C1608 CH 1H 101J-T	T	89.0/6.7
C723	4030007130	S.CER C1608 CH 1H 101J-T	T	78.3/3.1
C724	4030011340	S.CER C1608 CH 1H 471J-T	B	134.8/12.2
C725	4550007350	S.TAN F931C226MCMCMBMA	B	126.6/35.3
C726	4030006860	S.CER C1608 JB 1H 102K-T	B	91.4/111.1
C727	4030006860	S.CER C1608 JB 1H 102K-T	B	84.4/114.2
C728	4030006860	S.CER C1608 JB 1H 102K-T	B	91.3/112.6
C729	4030006860	S.CER C1608 JB 1H 102K-T	B	65.1/114.9
C732	4030011600	S.CER C1608 JB 1E 104K-T	T	71.9/2.6
C733	4030011600	S.CER C1608 JB 1E 104K-T	T	66.8/12.9
C734	4030006860	S.CER C1608 JB 1H 102K-T	B	63.6/1.9
C735	4030011600	S.CER C1608 JB 1E 104K-T	T	74.1/13.2
C736	4030011600	S.CER C1608 JB 1E 104K-T	B	67.4/1.9
C737	4030011600	S.CER C1608 JB 1E 104K-T	B	65.5/1.9
C738	4030011600	S.CER C1608 JB 1E 104K-T	B	68.2/14.5
C739	4030011600	S.CER C1608 JB 1E 104K-T	B	69.8/14.5
C741	4030011600	S.CER C1608 JB 1E 104K-T	B	78.6/6.4
C742	4030011600	S.CER C1608 JB 1E 104K-T	T	69.4/12.9
C743	4030006860	S.CER C1608 JB 1H 102K-T	T	68.1/12.9
C744	4030011600	S.CER C1608 JB 1E 104K-T	T	70.7/12.9
C745	4030011600	S.CER C1608 JB 1E 104K-T	B	77.7/14.3
C746	4030011600	S.CER C1608 JB 1E 104K-T	B	76.3/15.1
C747	4030011600	S.CER C1608 JB 1E 104K-T	T	98.5/4.1
C749	4030011600	S.CER C1608 JB 1E 104K-T	T	96.7/6.4
C750	4030006880	S.CER C1608 JB 1H 472K-T	T	94.3/6.4
C751	4030006860	S.CER C1608 JB 1H 102K-T	T	95.5/6.4
C752	4030011600	S.CER C1608 JB 1E 104K-T	T	93.1/6.4
C753	4030006880	S.CER C1608 JB 1H 472K-T	B	59.9/10.7
C754	4030006860	S.CER C1608 JB 1H 102K-T	B	66.6/14.5
C755	4030006860	S.CER C1608 JB 1H 102K-T	B	58.5/119.2
C757	4030011600	S.CER C1608 JB 1E 104K-T	B	76.4/8.0
C759	4030006880	S.CER C1608 JB 1H 472K-T	T	72.8/13.2
C760	4030006880	S.CER C1608 JB 1H 472K-T	B	74.8/8.0
C761	4030006880	S.CER C1608 JB 1H 472K-T	B	73.2/8.0
C762	4030006880	S.CER C1608 JB 1H 472K-T	B	70.0/8.0
C763	4030006880	S.CER C1608 JB 1H 472K-T	B	71.6/8.0
C764	4030006880	S.CER C1608 JB 1H 472K-T	B	62.0/1.9
C765	4030011600	S.CER C1608 JB 1E 104K-T	B	69.0/1.9
C766	4030006860	S.CER C1608 JB 1H 102K-T	B	66.6/8.7
C781	4030006860	S.CER C1608 JB 1H 102K-T	T	73.1/90.1
C782	4030006900	S.CER C1608 JB 1H 103K-T	T	71.9/84.3
C783	4030006880	S.CER C1608 JB 1H 472K-T	T	71.9/83.1
C801	4030007070	S.CER C1608 CH 1H 330J-T	T	55.1/58.5
C802	4030009470	S.CER C1608 CH 1H R75C-T	T	53.8/58.5
C803	4030007100	S.CER C1608 CH 1H 560J-T	T	53.8/53.3
C804	4030007030	S.CER C1608 CH 1H 150J-T	T	56.2/52.5
C805	4030007080	S.CER C1608 CH 1H 390J-T	T	53.8/51.7
C806	4030006880	S.CER C1608 JB 1H 472K-T	B	47.1/39.8

[PA UNIT]

REF NO.	PARTS NO.	DESCRIPTION	M.	H/V LOCATION
C807	4030011600	S.CER C1608 JB 1E 104K-T	B	43.2/38.6
C808	4030011600	S.CER C1608 JB 1E 104K-T	B	43.2/44.6
C820	4030011600	S.CER C1608 JB 1E 104K-T	B	54.2/91.3
C821	4030006880	S.CER C1608 JB 1H 472K-T	B	53.6/99.3
C822	4030011510	S.CER GRM31M2C2H560JV01L (GRM42-6 CH)	B	42.3/21.9
C823	4030011190	S.CER GRM31M2C2H270JV01L (GRM42-6 CH)	B	33.0/18.3
C824	4030012480	S.CER GRM31M2C2H121JV01L (GRM42-6 CH)	B	25.2/17.1
C825	4030011240	S.CER GRM31M2C2H470JV01L (GRM42-6 CH)	B	17.9/15.7
C826	4030011550	S.CER GRM31M2C2H680JV01L (GRM42-6 CH)	B	11.2/19.9
C827	4030011510	S.CER GRM31M2C2H560JV01L (GRM42-6 CH)	B	8.8/19.9
C828	4030006880	S.CER C1608 JB 1H 472K-T	T	5.2/106.8
C829	4030011600	S.CER C1608 JB 1E 104K-T	T	2.6/106.8
C830	4030011210	S.CER GRM31M2C2H330JV01L (GRM42-6 CH)	B	22.5/17.1
C831	4030006880	S.CER C1608 JB 1H 472K-T	B	8.1/110.4
C832	4030006880	S.CER C1608 JB 1H 472K-T	B	51.6/95.5
C833	4030011730	S.CER GRM31M2C2H101JV01L (GRM42-6 CH)	B	27.6/17.1
C835	4030012480	S.CER GRM31M2C2H121JV01L (GRM42-6 CH)	B	16.7/107.2
C836	4030012480	S.CER GRM31M2C2H121JV01L (GRM42-6 CH)	B	12.6/107.9
C837	4030012480	S.CER GRM31M2C2H121JV01L (GRM42-6 CH)	B	12.6/105.8
C840	4030011600	S.CER C1608 JB 1E 104K-T	B	46.8/97.3
C841	4030006880	S.CER C1608 JB 1H 472K-T	B	46.1/98.5
C842	4030011730	S.CER GRM31M2C2H101JV01L (GRM42-6 CH)	B	39.0/106.8
C843	4010008160	CER HM13SJ SL 431J 500V		
C844	4030011730	S.CER GRM31M2C2H101JV01L (GRM42-6 CH)	B	25.9/102.9
C845	4030014460	S.CER GRM31M2C2H820JV01L (GRM42-6 CH)	B	19.7/91.9
C846	4010005370	CER HM11SJ SL 331J 500V		
C847	4010005930	CER HM11SJ SL 391J 500V		
C848	4030011190	S.CER GRM31M2C2H270JV01L (GRM42-6 CH)	B	12.6/98.3
C849	4030011180	S.CER GRM31M2C2H220JV01L (GRM42-6 CH)	B	12.6/96.2
C850	4010005930	CER HM11SJ SL 391J 500V		
C851	4030012480	S.CER GRM31M2C2H121JV01L (GRM42-6 CH)	B	20.3/112.1
C852	4030006880	S.CER C1608 JB 1H 472K-T	T	5.3/90.6
C853	4030011600	S.CER C1608 JB 1E 104K-T	T	2.6/90.6
C854	4030006880	S.CER C1608 JB 1H 472K-T	B	7.8/92.0
C855	4030011730	S.CER GRM31M2C2H101JV01L (GRM42-6 CH)	B	28.0/104.9
C856	4030011510	S.CER GRM31M2C2H560JV01L (GRM42-6 CH)	B	31.2/105.5
C857	4030012480	S.CER GRM31M2C2H121JV01L (GRM42-6 CH)	B	43.1/108.4
C858	4030011730	S.CER GRM31M2C2H101JV01L (GRM42-6 CH)	B	20.3/110.0
C860	4030011600	S.CER C1608 JB 1E 104K-T	B	43.4/83.8
C861	4030006880	S.CER C1608 JB 1H 472K-T	B	46.6/83.8
C863	4030011170	S.CER GRM31M2C2H180JV01L (GRM42-6 CH)	B	37.5/93.5
C864	4030011510	S.CER GRM31M2C2H560JV01L (GRM42-6 CH)	B	28.5/82.6
C865	4030011110	S.CER GRM31M2C2H9R0DV01L (GRM42-6 CH)	B	29.5/78.6
C866	4030011230	S.CER GRM31M2C2H390JV01L (GRM42-6 CH)	B	24.5/78.1
C868	4030011240	S.CER GRM31M2C2H470JV01L (GRM42-6 CH)	B	26.9/78.6
C869	4030011180	S.CER GRM31M2C2H220JV01L (GRM42-6 CH)	B	10.3/83.6
C870	4030011170	S.CER GRM31M2C2H180JV01L (GRM42-6 CH)	B	17.0/77.7
C871	4030006880	S.CER C1608 JB 1H 472K-T	T	5.2/74.5
C872	4030011600	S.CER C1608 JB 1E 104K-T	T	2.5/74.5
C873	4030011070	S.CER GRM31M2C2H5R0CY21L (GRM42-6 CH)	B	33.2/92.6
C874	4030006880	S.CER C1608 JB 1H 472K-T	B	9.0/74.5
C876	4030011160	S.CER GRM31M2C2H150JV01L (GRM42-6 CH)	B	22.1/77.5
C880	4030011600	S.CER C1608 JB 1E 104K-T	B	43.4/69.1
C881	4030006880	S.CER C1608 JB 1H 472K-T	B	47.0/69.1
C882	4010007590	CER HM15SJ SL 681J 500V		
C883	4010007590	CER HM15SJ SL 681J 500V		
C884	4010005930	CER HM11SJ SL 391J 500V		
C885	4320000320	DIP DM20C 222J5		
C886	4030012480	S.CER GRM31M2C2H121JV01L (GRM42-6 CH)	B	31.5/57.2
C887	4030011730	S.CER GRM31M2C2H101JV01L (GRM42-6 CH)	B	33.9/57.2
C889	4030014460	S.CER GRM31M2C2H820JV01L (GRM42-6 CH)	B	18.0/65.3
C890	4320001250	DIP DM19C 162J5		
C893	4030006880	S.CER C1608 JB 1H 472K-T	T	5.3/58.4
C894	4030011600	S.CER C1608 JB 1E 104K-T	T	2.6/58.4
C900	4030011600	S.CER C1608 JB 1E 104K-T	B	44.1/54.4

M.=Mounted side (T: Mounted on the Top side, B: Mounted on the Bottom side)
S.=Surface mount

[PA UNIT]

REF NO.	PARTS NO.	DESCRIPTION	M.	H/V LOCATION
C901	4030006880	S.CER C1608 JB 1H 472K-T	B	46.9/54.4
C902	4010005870	CER HM95SJ SL 221J 500V		
C903	4030011190	S.CER GRM31M2C2H270JV01L (GRM42-6 CH)	B	30.9/42.7
C904	4030014460	S.CER GRM31M2C2H820JV01L (GRM42-6 CH)	B	28.4/42.7
C905	4010005870	CER HM95SJ SL 221J 500V		
C906	4030011510	S.CER GRM31M2C2H560JV01L (GRM42-6 CH)	B	17.0/44.0
C907	4030011510	S.CER GRM31M2C2H560JV01L (GRM42-6 CH)	B	10.8/49.5
C908	4030006880	S.CER C1608 JB 1H 472K-T	T	5.3/42.2
C909	4030011600	S.CER C1608 JB 1E 104K-T	T	2.6/42.2
C920	4030011600	S.CER C1608 JB 1E 104K-T	B	43.2/25.1
C921	4030006880	S.CER C1608 JB 1H 472K-T	B	47.1/25.4
C922	4010007590	CER HM15SJ SL 681J 500V		
C923	4030011730	S.CER GRM31M2C2H101JV01L (GRM42-6 CH)	B	31.4/27.3
C924	4010006410	CER HM13SJ SL 471J 500V		
C925	4030014460	S.CER GRM31M2C2H820JV01L (GRM42-6 CH)	B	15.8/29.5
C926	4010006410	CER HM13SJ SL 471J 500V		
C927	4010005930	CER HM11SJ SL 391J 500V		
C928	4010005930	CER HM11SJ SL 391J 500V		
C929	4030006880	S.CER C1608 JB 1H 472K-T	T	5.3/25.9
C930	4030011600	S.CER C1608 JB 1E 104K-T	T	2.6/25.9
C931	4030014460	S.CER GRM31M2C2H820JV01L (GRM42-6 CH)	B	34.1/27.3
C932	4030011730	S.CER GRM31M2C2H101JV01L (GRM42-6 CH)	B	33.3/32.4
C933	4030011730	S.CER GRM31M2C2H101JV01L (GRM42-6 CH)	B	29.7/30.9
C940	4030011600	S.CER C1608 JB 1E 104K-T	B	43.6/11.1
C941	4030006880	S.CER C1608 JB 1H 472K-T	B	43.6/14.2
C942	4030014460	S.CER GRM31M2C2H820JV01L (GRM42-6 CH)	B	39.5/119.2
C943	4030011210	S.CER GRM31M2C2H330JV01L (GRM42-6 CH)	B	28.9/111.7
C944	4030014460	S.CER GRM31M2C2H820JV01L (GRM42-6 CH)	B	24.7/118.4
C945	4030011170	S.CER GRM31M2C2H180JV01L (GRM42-6 CH)	B	16.5/118.1
C947	4030006880	S.CER C1608 JB 1H 472K-T	T	5.3/9.9
C948	4030011600	S.CER C1608 JB 1E 104K-T	T	2.6/9.9
C949	4030011050	S.CER GRM31M3C2H3R0CY21L (GRM42-6 CJ)	B	28.9/109.6
C960	4030010760	S.CER C1608 CH 1H 331J-T	T	18.2/130.2
C961	4030011600	S.CER C1608 JB 1E 104K-T	B	45.1/134.1
C962	4030006880	S.CER C1608 JB 1H 472K-T	B	39.0/137.9
C963	4030006880	S.CER C1608 JB 1H 472K-T	B	38.7/126.3
C964	4610002120	S.TRI TZB4Z100EB10R00 (TZBX4Z100BE110)	T	3.3/126.6
C966	4030006880	S.CER C1608 JB 1H 472K-T	B	21.3/131.2
C968	4030011340	S.CER C1608 CH 1H 471J-T	B	31.0/130.6
C969	4030011340	S.CER C1608 CH 1H 471J-T	B	31.0/133.7
C970	4030010760	S.CER C1608 CH 1H 331J-T	B	22.0/132.8
C971	4030011340	S.CER C1608 CH 1H 471J-T	B	35.8/133.7
C972	4030011790	S.CER GRM55RF52A684ZD01L (GRM44-1)	B	3.4/136.4
C973	4030007090	S.CER C1608 CH 1H 470J-T	T	8.4/129.8
C979	4030006880	S.CER C1608 JB 1H 472K-T	T	51.8/38.6
C987	4030006880	S.CER C1608 JB 1H 472K-T	B	28.9/3.3
C988	4030006880	S.CER C1608 JB 1H 472K-T	B	26.3/3.3
C989	4030006880	S.CER C1608 JB 1H 472K-T	B	25.0/2.6
C990	4030006880	S.CER C1608 JB 1H 472K-T	T	20.6/3.0
C991	4030006880	S.CER C1608 JB 1H 472K-T	T	20.6/4.2
C992	4030006880	S.CER C1608 JB 1H 472K-T	T	20.6/5.4
C993	4030006880	S.CER C1608 JB 1H 472K-T	T	20.6/6.6
C994	4030011600	S.CER C1608 JB 1E 104K-T	B	29.5/6.2
C995	4030006880	S.CER C1608 JB 1H 472K-T	B	23.7/3.4
C996	4030007090	S.CER C1608 CH 1H 470J-T	T	20.6/9.0
C997	4030007090	S.CER C1608 CH 1H 470J-T	T	20.6/7.8
C998	4030007090	S.CER C1608 CH 1H 470J-T	T	20.6/10.2
C999	4030006860	S.CER C1608 JB 1H 102K-T	T	56.9/9.5
C1000	4030006860	S.CER C1608 JB 1H 102K-T	B	55.6/5.1
C1001	4030011600	S.CER C1608 JB 1E 104K-T	B	51.7/1.7
C1002	4030006880	S.CER C1608 JB 1H 472K-T	B	27.6/2.6
C1003	4030011600	S.CER C1608 JB 1E 104K-T	T	49.8/7.6
C1004	4030011510	S.CER GRM31M2C2H560JV01L (GRM42-6 CH)	B	39.9/21.9
C1005	4030011550	S.CER GRM31M2C2H680JV01L (GRM42-6 CH)	B	16.8/91.9
C1006	4030014460	S.CER GRM31M2C2H820JV01L (GRM42-6 CH)	B	39.0/109.2
C1007	4030011550	S.CER GRM31M2C2H680JV01L (GRM42-6 CH)	B	18.1/62.1
C1009	4030011510	S.CER GRM31M2C2H560JV01L (GRM42-6 CH)	B	20.6/118.7
C1010	4030014460	S.CER GRM31M2C2H820JV01L (GRM42-6 CH)	B	27.1/119.6
C1121	4010006410	CER HM13SJ SL 471J 500V		
RL701	6330001550	REL JV-12-KT		
RL801	6330001721	REL ATN207-K1		
RL820	6330001721	REL ATN207-K1		
RL821	6330001721	REL ATN207-K1		
RL840	6330001721	REL ATN207-K1		

[PA UNIT]

REF NO.	PARTS NO.	DESCRIPTION	M.	H/V LOCATION
RL841	6330001721	REL ATN207-K1		
RL860	6330001721	REL ATN207-K1		
RL861	6330001721	REL ATN207-K1		
RL880	6330001721	REL ATN207-K1		
RL881	6330001721	REL ATN207-K1		
RL900	6330001721	REL ATN207-K1		
RL901	6330001721	REL ATN207-K1		
RL920	6330001721	REL ATN207-K1		
RL921	6330001721	REL ATN207-K1		
RL940	6330001721	REL ATN207-K1		
RL941	6330001721	REL ATN207-K1		
J2	6510023512	S.CON 28FLT-SM2-TB(LF)(SN)(M)	T	80.1/6.0
J980	6510023512	S.CON 28FLT-SM2-TB(LF)(SN)(M)	T	63.7/6.0
F1	5220000341	HOL FHA010-03F		
F2	5210000940	FUS 1205		
W701	8900013900	CAB OPC-1455		
W702	8900013910	CAB OPC-1456		
W801	7120000480	S.JUM MJP-0.4-T	B	8.3/101.0
W901	7120000480	S.JUM MJP-0.4-T	T	56.7/22.0
EP202	6910012350	S.BEA MMZ1608Y 102BT	B	136.0/51.4
EP703	6910012350	S.BEA MMZ1608Y 102BT	B	142.6/13.9
EP741	6910012350	S.BEA MMZ1608Y 102BT	B	76.4/12.0
EP742	6910012350	S.BEA MMZ1608Y 102BT	B	77.8/11.3
EP743	6910012350	S.BEA MMZ1608Y 102BT	B	59.8/99.6
EP747	6910012350	S.BEA MMZ1608Y 102BT	T	65.1/9.7
EP748	6910012350	S.BEA MMZ1608Y 102BT	T	63.8/9.7
EP751	6910012350	S.BEA MMZ1608Y 102BT	T	74.1/9.6
EP752	6910012350	S.BEA MMZ1608Y 102BT	B	63.4/5.3
EP753	6910012350	S.BEA MMZ1608Y 102BT	T	66.4/9.7
EP754	6910012350	S.BEA MMZ1608Y 102BT	B	59.4/115.9
EP756	6910012350	S.BEA MMZ1608Y 102BT	T	68.6/2.6
EP758	6910012350	S.BEA MMZ1608Y 102BT	T	70.4/9.6
EP759	6910012350	S.BEA MMZ1608Y 102BT	T	69.1/9.6
EP760	6910012350	S.BEA MMZ1608Y 102BT	T	60.7/10.0
EP761	6910012350	S.BEA MMZ1608Y 102BT	T	62.6/9.7
EP762	6910012350	S.BEA MMZ1608Y 102BT	B	61.0/4.6
EP763	6910012350	S.BEA MMZ1608Y 102BT	B	63.4/105.7
EP767	6910012350	S.BEA MMZ1608Y 102BT	B	76.4/5.2
EP772	6910012350	S.BEA MMZ1608Y 102BT	T	96.5/3.8
EP774	6910012350	S.BEA MMZ1608Y 102BT	T	72.8/9.6
EP775	6910012350	S.BEA MMZ1608Y 102BT	B	74.8/5.2
EP776	6910012350	S.BEA MMZ1608Y 102BT	B	73.2/5.2
EP777	6910012350	S.BEA MMZ1608Y 102BT	B	70.0/5.2
EP778	6910012350	S.BEA MMZ1608Y 102BT	B	71.6/5.2
EP779	6910012350	S.BEA MMZ1608Y 102BT	B	68.2/5.3

M.=Mounted side (T: Mounted on the Top side, B: Mounted on the Bottom side) S.=Surface mount

[DRIVER UNIT]

REF NO.	PARTS NO.	DESCRIPTION	M.	H/V LOCATION
Q504	1590003061	S.FET PD55015-E	T	20.0/9.7
R102	7070000271	RES ERG1SJ 101 (100)		
C101	4030004750	S.CER C2012 JB 1H 103K-T	T	24.6/18.2
C102	4030011230	S.CER GRM31M2C2H390JV01L (GRM42-6 CH)	T	11.2/4.3
J101	6910016830	CON IMSA-9230B-1-04Z149-PT1		
J102	6910016830	CON IMSA-9230B-1-04Z149-PT1		
J103	6910016830	CON IMSA-9230B-1-04Z149-PT1		
J104	6910016830	CON IMSA-9230B-1-04Z149-PT1		
J107	6910016830	CON IMSA-9230B-1-04Z149-PT1		

[DISPLAY UNIT]

REF NO.	PARTS NO.	DESCRIPTION	M.	H/V LOCATION
IC1	6910016731	S.DC XC9504B092AR-G	B	44.5/9.4
IC101	1180001072	S.IC TA7805F(TE16L1NQ)	B	90.3/6.9
IC151	1180002201	S.IC RN5RZ33BA-TR-F	B	99.9/4.8
IC301	1110002751	S.IC TA75S01F(TE85RF)	B	113.8/7.6
IC506	1120003010	S.IC AN2533FH-V	B	69.0/38.5
IC651	1110005420	S.IC BA15532F-E2	B	4.1/25.6
IC2003	1140013140	S.IC HD64338020SB68HV(SX-2427C)	B	93.0/26.3
IC2007	1110005821	S.IC R3112N281A-TR-F	B	108.7/46.9
Q1	1550000090	S.FET RSQ035P03TR	B	39.5/9.9
Q51	1560001330	S.FET RSR025N03	B	52.1/10.6
Q301	1560001290	S.FET 2SK3065 T100	T	110.8/31.4
Q302	1590003940	S.TRA RN1105(TE85LF)	T	116.7/10.2
Q303	1590003930	S.TRA UMD22N TR	T	113.1/11.6
Q651	1590001650	S.TRA XP4601(TX)	B	10.6/28.8
Q652	1590001650	S.TRA XP4601(TX)	B	11.1/20.6
Q653	1590001650	S.TRA XP4601(TX)	B	10.7/26.2
Q654	1590001650	S.TRA XP4601(TX)	B	11.1/17.0
Q701	1530002060	S.TRA 2SC4081 T106 R	T	19.1/50.3
Q721	1530002060	S.TRA 2SC4081 T106 R	T	22.0/5.9
Q741	1530002060	S.TRA 2SC4081 T106 R	T	94.0/50.1
Q761	1530002060	S.TRA 2SC4081 T106 R	T	104.2/50.1
Q771	1530002060	S.TRA 2SC4081 T106 R	T	18.4/25.2
Q781	1530002060	S.TRA 2SC4081 T106 R	T	5.3/23.6
Q802	1520000460	S.TRA 2SB1132 T100 R	B	58.8/21.6
Q851	1590004360	S.FET CPH3414-TL-E	B	39.9/18.4
Q2001	1590003940	S.TRA RN1105(TE85LF)	B	81.6/23.8
Q2002	1590001870	S.TRA DTA114EE TL	B	80.2/29.8
Q2003	1590003480	S.TRA DTC114TE TL	B	82.2/32.3
D1	1790000971	S.DIO MA2J7290GL	B	36.9/10.2
D51	1750000731	S.DIO MA2SD100GL	B	51.0/8.1
D301	1790001251	S.DIO MA2S1110GL	B	111.1/32.1
D302	1790001521	S.ZEN MAZ8075GLL	B	109.9/7.6
D601	1750000951	S.DIO MA2J7320GL	B	51.6/39.9
D602	1750000951	S.DIO MA2J7320GL	B	53.4/39.9
D801	1730002341	S.ZEN MAZ8047GML	B	35.0/40.5
D802	1730002341	S.ZEN MAZ8047GML	B	39.8/25.9
D803	1730002341	S.ZEN MAZ8047GML	B	39.5/22.9
D804	1730002341	S.ZEN MAZ8047GML	B	42.1/22.9
D2001	1750000951	S.DIO MA2J7320GL	T	107.5/26.5
D2002	1790001670	S.DIO RB706F-40T106	B	76.6/16.9
D2003	1790001670	S.DIO RB706F-40T106	T	116.5/36.8
D2004	1750000370	S.DIO DA221 TL	T	100.6/41.8
D2005	1750000370	S.DIO DA221 TL	B	101.7/42.8
D2006	1750000370	S.DIO DA221 TL	B	107.3/5.9
X501	6050012150	S.XTA CR-806 SMD-49TA 4.433619 MHz <KDS> [EUR]	B	87.0/43.5x
	6050012150	S.XTA CR-806 SMD-49TA 4.433619 MHz <KDS> [FRA]		
	6050012150	S.XTA CR-806 SMD-49TA 4.433619 MHz <KDS> [ESP]		
	6050012140	S.XTA CR-805 SMD-49TA 3.579545 MHz <KDS> [USA]		
	6050012150	S.XTA CR-806 SMD-49TA 4.433619 MHz <KDS> [EXP]		
	6050012150	S.XTA CR-806 SMD-49TA 4.433619 MHz <KDS> [ITR]		
	6050012150	S.XTA CR-806 SMD-49TA 4.433619 MHz <KDS> [UK]		
	6050012140	S.XTA CR-805 SMD-49TA 3.579545 MHz <KDS> [KOR]		
	6050012150	S.XTA CR-806 SMD-49TA 4.433619 MHz <KDS> [AUS]		
	6050012150	S.XTA CR-806 SMD-49TA 4.433619 MHz <KDS> [CHN]		
X2001	6050011550	S.XTA CR-747 SMD-49TA 9.8304 MHz <KDS>	B	106.5/27.0
L1	6190001561	S.COI CDRH5D18NP-101NCI	B	68.4/6.4
L2	6190001561	S.COI CDRH5D18NP-101NCI	B	34.6/5.2
L3	6200002041	S.COI NLV25T-101J	B	30.7/10.4
L51	6190001561	S.COI CDRH5D18NP-101NCI	B	56.0/6.2
L53	6200002041	S.COI NLV25T-101J	B	60.9/11.0
L101	6200001831	S.COI NLV32T-100J	B	96.0/11.6
L151	6200001831	S.COI NLV32T-100J	B	96.0/8.6
L152	6200001831	S.COI NLV32T-100J	B	100.6/11.4
L251	6200003950	S.COI HF50ACC 322513-T	B	145.8/44.0
L252	6200003950	S.COI HF50ACC 322513-T	B	145.2/50.9
L301	6200002041	S.COI NLV25T-101J	B	109.7/16.8
L302	6200005011	S.COI NLV25T-100J	T	112.6/24.1
L303	6200002041	S.COI NLV25T-101J	T	112.1/20.4
L306	6200003261	S.COI NLV32T-101J	T	109.9/25.6
L307	6200002041	S.COI NLV25T-101J	T	115.4/26.6
L309	6200002041	S.COI NLV25T-101J	T	115.4/24.1
L310	6200002041	S.COI NLV25T-101J	T	115.5/21.6
L312	6200002041	S.COI NLV25T-101J	T	115.5/19.1
L313	6200002041	S.COI NLV25T-101J	T	115.8/16.3
L505	6200005521	S.COI NLV25T-470J	B	71.2/47.9
L506	6200005011	S.COI NLV25T-100J	B	68.0/20.2
L507	6200005011	S.COI NLV25T-100J	B	50.3/29.0
L508	6200005011	S.COI NLV25T-100J	B	49.3/24.4
L509	6200005011	S.COI NLV25T-100J	B	17.4/35.7

M.=Mounted side (T: Mounted on the Top side, B: Mounted on the Bottom side)
S.=Surface mount

[DISPLAY UNIT]

REF NO.	PARTS NO.	DESCRIPTION	M.	H/V LOCATION
L601	6200002041	S.COI NLV25T-101J	B	70.6/25.2
L602	6200005011	S.COI NLV25T-100J	B	53.5/36.2
L603	6200005011	S.COI NLV25T-100J	B	51.0/43.3
L604	6200005011	S.COI NLV25T-100J	B	53.5/43.3
L605	6200005011	S.COI NLV25T-100J	B	50.9/36.2
L651	6200002041	S.COI NLV25T-101J	B	19.1/42.8
L701	6200002041	S.COI NLV25T-101J	B	21.1/37.5
L702	6200002041	S.COI NLV25T-101J	B	65.4/11.0
L703	6200002041	S.COI NLV25T-101J	B	28.0/11.3
L801	6200005011	S.COI NLV25T-100J	B	63.5/17.0
L802	6200002041	S.COI NLV25T-101J	B	19.1/47.5
L851	6200003950	S.COI HF50ACC 322513-T	B	33.2/17.2
L852	6200003950	S.COI HF50ACC 322513-T	B	35.0/21.4
L853	6200002041	S.COI NLV25T-101J	B	34.4/26.6
L854	6200002041	S.COI NLV25T-101J	B	34.4/24.1
L855	6200003950	S.COI HF50ACC 322513-T	B	36.5/17.2
R1	7030008141	S.RES ERA3YKD 224V (220K)	B	33.5/9.7
R2	7030005671	S.RES ERA3YKD 393V (39K)	B	33.5/11.6
R3	7030008051	S.RES ERA3YKD 184V (180K)	B	42.6/6.4
R4	7030005050	S.RES ERJ2GEJ 103 X (10K)	B	40.9/6.8
R5	7030005050	S.RES ERJ2GEJ 103 X (10K)	B	40.9/7.7
R51	7030008141	S.RES ERA3YKD 224V (220K)	B	49.8/10.8
R52	7030007911	S.RES ERA3YKD 563V (56K)	B	48.6/10.8
R53	7030006561	S.RES ERA3YED 223V (22K)	B	46.6/11.8
R54	7030005050	S.RES ERJ2GEJ 103 X (10K)	B	48.0/8.4
R55	7030005050	S.RES ERJ2GEJ 103 X (10K)	B	48.9/8.4
R201	7030010040	S.RES ERJ2GEJ-JPW	B	109.7/38.1
R202	7030010040	S.RES ERJ2GEJ-JPW	B	109.7/39.1
R251	7030005120	S.RES ERJ2GEJ 102 X (1K)	B	136.6/49.6
R252	7030000300	S.RES MCR10EZJH 220 (221)	B	133.9/47.3
R253	7030000300	S.RES MCR10EZJH 220 (221)	B	141.3/51.5
R254	7030000300	S.RES MCR10EZJH 220 (221)	B	133.9/49.1
R255	7030000300	S.RES MCR10EZJH 220 (221)	T	142.6/51.4
R301	7030005120	S.RES ERJ2GEJ 102 X (1K)	B	113.3/32.1
R302	7030005050	S.RES ERJ2GEJ 103 X (10K)	T	114.0/30.5
R303	7030005120	S.RES ERJ2GEJ 102 X (1K)	B	111.1/33.4
R304	7030007300	S.RES ERJ2GEJ 332 X (3.3K)	B	112.0/33.4
R305	7030007300	S.RES ERJ2GEJ 332 X (3.3K)	B	113.3/33.0
R306	7030005120	S.RES ERJ2GEJ 102 X (1K)	T	114.9/11.0
R307	7030005050	S.RES ERJ2GEJ 103 X (10K)	B	111.3/8.4
R308	7030005230	S.RES ERJ2GEJ 334 X (330K)	B	113.8/5.4
R309	7030005310	S.RES ERJ2GEJ 124 X (120K)	B	112.0/5.4
R310	7030008010	S.RES ERJ2GEJ 123 X (12K)	B	110.2/5.4
R521	7030008370	S.RES ERJ2GEJ 561 X (560)	B	61.9/46.3
R522	7030010040	S.RES ERJ2GEJ-JPW	B	65.3/47.4
R523	7030010040	S.RES ERJ2GEJ-JPW	B	65.4/48.7
R524	7030010900	S.RES ERJ3GEYJ 750 V (75)	B	63.2/49.0
R528	7030010040	S.RES ERJ2GEJ-JPW	B	60.8/42.7
R529	7030005050	S.RES ERJ2GEJ 103 X (10K)	B	58.6/43.9
R530	7030005080	S.RES ERJ2GEJ 823 X (82K)	B	60.8/43.7
R531	7030009290	S.RES ERJ2GEJ 562 X (5.6K)	B	76.3/43.0
R532	7030005050	S.RES ERJ2GEJ 103 X (10K)	B	60.8/37.2
R533	7030010040	S.RES ERJ2GEJ-JPW	B	56.6/32.3
R534	7030010040	S.RES ERJ2GEJ-JPW	B	60.8/36.0
R536	7030010040	S.RES ERJ2GEJ-JPW	B	62.6/29.0
R537	7030010040	S.RES ERJ2GEJ-JPW	B	64.6/29.0
R538	7030010040	S.RES ERJ2GEJ-JPW	B	66.6/29.0
R539	7030005720	S.RES ERJ2GEJ 563 X (56K)	B	69.7/29.0
R540	7030010040	S.RES ERJ2GEJ-JPW	B	68.6/29.0
R541	7310004650	S.TRI EVM-2WSX80 B53 (502)	B	53.3/49.3
R544	7030010040	S.RES ERJ2GEJ-JPW	B	60.8/39.6
R545	7030005720	S.RES ERJ2GEJ 563 X (56K)	B	60.8/32.0
R546	7030010040	S.RES ERJ2GEJ-JPW	B	60.8/34.0
R547	7030010040	S.RES ERJ2GEJ-JPW	B	59.2/34.8
R548	7030010040	S.RES ERJ2GEJ-JPW	B	60.8/33.0
R549	7030010040	S.RES ERJ2GEJ-JPW	B	63.6/29.0
R550	7030010040	S.RES ERJ2GEJ-JPW	B	65.6/29.0
R551	7030010040	S.RES ERJ2GEJ-JPW	B	67.6/29.0
R553	7030010040	S.RES ERJ2GEJ-JPW	B	59.5/43.9
R601	7030008410	S.RES ERJ2GEJ 392 X (3.9K)	B	72.7/24.9
R602	7030008410	S.RES ERJ2GEJ 392 X (3.9K)	B	74.5/24.9
R603	7030008410	S.RES ERJ2GEJ 392 X (3.9K)	B	75.4/24.9
R604	7030008410	S.RES ERJ2GEJ 392 X (3.9K)	B	77.2/24.9
R605	7030008410	S.RES ERJ2GEJ 392 X (3.9K)	B	75.4/30.2
R606	7030008410	S.RES ERJ2GEJ 392 X (3.9K)	B	76.3/24.9
R608	7030010040	S.RES ERJ2GEJ-JPW	B	48.8/36.8
R609	7030005040	S.RES ERJ2GEJ 472 X (4.7K)	B	48.5/44.4
R610	7030010040	S.RES ERJ2GEJ-JPW	B	48.8/41.7
R612	7030005040	S.RES ERJ2GEJ 472 X (4.7K)	B	48.8/42.6
R613	7030003470	S.RES ERJ3GEYJ 182 V (1.8K)	B	52.6/46.1
R614	7030003470	S.RES ERJ3GEYJ 182 V (1.8K)	B	50.8/46.3
R651	7030005050	S.RES ERJ2GEJ 103 X (10K)	B	5.5/19.7
R652	7030005220	S.RES ERJ2GEJ 223 X (22K)	B	0.8/25.5
R653	7030005060	S.RES ERJ2GEJ 333 X (33K)	B	5.5/21.5
R654	7030005070	S.RES ERJ2GEJ 683 X (68K)	B	0.8/23.9
R655	7030005090	S.RES ERJ2GEJ 104 X (100K)	B	4.1/30.7
R656	7030005110	S.RES ERJ2GEJ 224 X (220K)	B	0.8/27.4
R657	7030005060	S.RES ERJ2GEJ 333 X (33K)	B	1.8/30.0
R658	7030005090	S.RES ERJ2GEJ 104 X (100K)	B	4.1/29.8
R659	7030003600	S.RES ERJ3GEYJ 223 V (22K)	B	8.4/28.5
R660	7030005720	S.RES ERJ2GEJ 563 X (56K)	B	13.3/30.0
R661	7030005220	S.RES ERJ2GEJ 223 X (22K)	B	13.7/27.2
R662	7030007350	S.RES ERJ2GEJ 393 X (39K)	B	13.7/28.8
R663	7030005220	S.RES ERJ2GEJ 223 X (22K)	B	13.2/20.6
R664	7030007340	S.RES ERJ2GEJ 153 X (15K)	B	5.7/29.8
R665	7030003600	S.RES ERJ3GEYJ 223 V (22K)	B	8.9/20.6

[DISPLAY UNIT]

REF NO.	PARTS NO.	DESCRIPTION	M.	H/V LOCATION
R666	7030004980	S.RES ERJ2GEJ 101 X (100)	B	13.1/25.3
R667	7030004980	S.RES ERJ2GEJ 101 X (100)	B	11.1/18.8
R668	7030004980	S.RES ERJ2GEJ 101 X (100)	B	9.8/24.2
R669	7030004980	S.RES ERJ2GEJ 101 X (100)	B	13.6/16.2
R701	7030004990	S.RES ERJ2GEJ 221 X (220)	T	18.5/48.0
R702	7030007280	S.RES ERJ2GEJ 331 X (330)	T	19.8/48.0
R703	7030007290	S.RES ERJ2GEJ 222 X (2.2K)	T	25.1/41.0
R704	7030005040	S.RES ERJ2GEJ 472 X (4.7K)	T	16.6/17.3
R705	7030007340	S.RES ERJ2GEJ 153 X (15K)	T	18.7/6.4
R721	7030004990	S.RES ERJ2GEJ 221 X (220)	T	20.2/6.3
R722	7030007280	S.RES ERJ2GEJ 331 X (330)	T	23.8/5.7
R723	7030003480	S.RES ERJ3GEYJ 222 V (2.2K)	T	47.5/2.4
R724	7030003520	S.RES ERJ3GEYJ 472 V (4.7K)	T	61.8/2.4
R725	7030003580	S.RES ERJ3GEYJ 153 V (15K)	T	75.9/2.4
R741	7030004990	S.RES ERJ2GEJ 221 X (220)	T	92.3/49.8
R742	7030007280	S.RES ERJ2GEJ 331 X (330)	T	95.8/49.7
R743	7030007290	S.RES ERJ2GEJ 222 X (2.2K)	T	102.1/35.0
R744	7030005040	S.RES ERJ2GEJ 472 X (4.7K)	T	102.1/25.5
R745	7030007340	S.RES ERJ2GEJ 153 X (15K)	T	100.6/8.6
R761	7030004990	S.RES ERJ2GEJ 221 X (220)	T	103.1/48.2
R762	7030007280	S.RES ERJ2GEJ 331 X (330)	T	104.9/47.9
R771	7030004990	S.RES ERJ2GEJ 221 X (220)	T	18.7/28.9
R772	7030007280	S.RES ERJ2GEJ 331 X (330)	T	18.1/29.9
R781	7030004990	S.RES ERJ2GEJ 221 X (220)	T	3.5/22.4
R782	7030007280	S.RES ERJ2GEJ 331 X (330)	T	3.5/24.2
R801	7030005240	S.RES ERJ2GEJ 473 X (47K)	B	62.1/21.8
R802	7030007270	S.RES ERJ2GEJ 151 X (150)	B	62.1/20.0
R803	7030005120	S.RES ERJ2GEJ 102 X (1K)	B	62.1/23.6
R2002	7030005240	S.RES ERJ2GEJ 473 X (47K)	T	110.4/40.7
R2003	7030005050	S.RES ERJ2GEJ 103 X (10K)	T	24.6/24.2
R2004	7030005050	S.RES ERJ2GEJ 103 X (10K)	T	24.6/26.3
R2005	7030005050	S.RES ERJ2GEJ 103 X (10K)	T	24.6/23.3
R2006	7030005050	S.RES ERJ2GEJ 103 X (10K)	T	24.6/25.3
R2007	7030007290	S.RES ERJ2GEJ 222 X (2.2K)	T	107.6/24.5
R2008	7030005220	S.RES ERJ2GEJ 223 X (22K)	B	78.3/18.4
R2009	7030005240	S.RES ERJ2GEJ 473 X (47K)	T	107.9/33.1
R2010	7030005090	S.RES ERJ2GEJ 104 X (100K)	B	79.7/16.9
R2011	7030005160	S.RES ERJ2GEJ 105 X (1M)	B	103.3/26.9
R2012	7030008010	S.RES ERJ2GEJ 123 X (12K)	B	103.3/23.3
R2013	7030005240	S.RES ERJ2GEJ 473 X (47K)	B	96.7/37.9
R2014	7030005290	S.RES ERJ2GEJ 682 X (6.8K)	T	24.1/41.0
R2015	7030005050	S.RES ERJ2GEJ 103 X (10K)	B	106.0/44.6
R2016	7030005240	S.RES ERJ2GEJ 473 X (47K)	B	92.2/37.9
R2017	7030005290	S.RES ERJ2GEJ 682 X (6.8K)	T	33.4/3.7
R2018	7030005290	S.RES ERJ2GEJ 682 X (6.8K)	T	102.2/41.8
R2019	7030005240	S.RES ERJ2GEJ 473 X (47K)	B	84.9/33.9
R2020	7030003450	S.RES ERJ3GEYJ 122 V (1.2K)	B	91.3/43.1
R2021	7030005240	S.RES ERJ2GEJ 473 X (47K)	B	97.1/40.8
R2022	7030005240	S.RES ERJ2GEJ 473 X (47K)	B	92.3/42.3
R2023	7030005240	S.RES ERJ2GEJ 473 X (47K)	B	100.1/42.8
R2024	7030005240	S.RES ERJ2GEJ 473 X (47K)	B	94.3/42.3
R2025	7030005240	S.RES ERJ2GEJ 473 X (47K)	B	93.3/42.3
R2026	7030005240	S.RES ERJ2GEJ 473 X (47K)	B	72.4/16.8
R2027	7030005240	S.RES ERJ2GEJ 473 X (47K)	B	70.6/16.9
R2028	7030005240	S.RES ERJ2GEJ 473 X (47K)	B	98.9/42.8
R2029	7030005240	S.RES ERJ2GEJ 473 X (47K)	B	73.5/16.8
R2030	7030007270	S.RES ERJ2GEJ 151 X (150)	T	108.0/11.8
R2031	7030007280	S.RES ERJ2GEJ 331 X (330)	T	108.8/40.2
R2033	7030007270	S.RES ERJ2GEJ 151 X (150)	T	19.5/20.3
R2034	7030005120	S.RES ERJ2GEJ 102 X (1K)	B	32.2/28.3
R2035	7030005120	S.RES ERJ2GEJ 102 X (1K)	B	32.6/30.9
R2036	7030005240	S.RES ERJ2GEJ 473 X (47K)	B	94.9/37.9
R2037	7030005240	S.RES ERJ2GEJ 473 X (47K)	B	94.0/37.9
R2039	7030005240	S.RES ERJ2GEJ 473 X (47K)	T	107.6/23.6
R2040	7030007340	S.RES ERJ2GEJ 153 X (15K)	B	116.4/8.8
R2041	7030007340	S.RES ERJ2GEJ 153 X (15K)	B	116.3/7.7
R2042	7030005050	S.RES ERJ2GEJ 103 X (10K)	B	79.7/31.3
R2043	7030005090	S.RES ERJ2GEJ 104 X (100K)	B	82.0/30.4
C2	4030018960	S.CER C3216 JB 1C 106MT-N	B	62.2/7.0
C3	4030018960	S.CER C3216 JB 1C 106MT-N	B	77.0/9.8
C4	4030017420	S.CER C1005 CH 1H 470J-T	B	35.4/10.7
C6	4030018960	S.CER C3216 JB 1C 106MT-N	B	28.1/6.1
C8	4030018960	S.CER C3216 JB 1C 106MT-N	B	30.2/6.1
C9	4030018960	S.CER C3216 JB 1C 106MT-N	B	39.2/4.5
C51	4030017420	S.CER C1005 CH 1H 470J-T	B	48.8/8.4
C53	4030018960	S.CER C3216 JB 1C 106MT-N	B	51.6/4.4
C55	4030018960	S.CER C3216 JB 1C 106MT-N	B	56.3/11.1
C56	4030018960	S.CER C3216 JB 1C 106MT-N	B	61.9/3.6
C57	4030017490	S.CER C1608 JB 1A 105K-T	B	44.0/11.8
C101	4030018960	S.CER C3216 JB 1C 106MT-N	B	85.7/6.3
C102	4030018960	S.CER C3216 JB 1C 106MT-N	B	94.7/4.6
C103	4030016930	S.CER C1005 JB 1A 104K-T	B	91.1/12.2
C104	4030016930	S.CER C1005 JB 1A 104K-T	B	89.5/12.2
C151	4550006250	S.TAN TEESVA 1A 106M8R	B	97.0/4.6
C152	4550006250	S.TAN TEESVA 1A 106M8R	B	100.7/7.7
C153	4030016930	S.CER C1005 JB 1A 104K-T	B	99.7/2.6
C154				

[DISPLAY UNIT]

REF NO.	PARTS NO.	DESCRIPTION	M.	H/V LOCATION
C304	4030017780	S.CER C1005 JB 1H 472K-T	B	113.3/33.9
C305	4030017780	S.CER C1005 JB 1H 472K-T	T	114.9/12.6
C306	4030017780	S.CER C1005 JB 1H 472K-T	B	113.8/4.4
C312	4030017780	S.CER C1005 JB 1H 472K-T	T	108.2/29.7
C315	4030017780	S.CER C1005 JB 1H 472K-T	B	25.2/20.0
C316	4030017780	S.CER C1005 JB 1H 472K-T	B	26.1/20.0
C317	4030017780	S.CER C1005 JB 1H 472K-T	B	27.0/20.0
C318	4030017780	S.CER C1005 JB 1H 472K-T	B	24.0/19.9
C319	4030017780	S.CER C1005 JB 1H 472K-T	B	27.2/32.5
C320	4030017780	S.CER C1005 JB 1H 472K-T	B	26.3/32.5
C321	4030017780	S.CER C1005 JB 1H 472K-T	B	25.6/31.2
C322	4030017780	S.CER C1005 JB 1H 472K-T	T	24.6/27.3
C501	4550007140	S.TAN TEESVD 1C 107M12R	B	53.4/21.0
C502	4550007140	S.TAN TEESVD 1C 107M12R	B	45.4/21.0
C513	4030016930	S.CER C1005 JB 1A 104K-T	B	64.3/47.4
C514	4030016930	S.CER C1005 JB 1A 104K-T	B	63.3/47.4
C515	4030017490	S.CER C1608 JB 1A 105K-T	B	61.5/44.9
C516	4030018910	S.CER C1608 JB 0J 475K-T	B	67.7/48.9
C517	4030017490	S.CER C1608 JB 1A 105K-T	B	75.6/47.9
C518	4030017650	S.CER C1005 CH 1H 270J-T	[EUR] B	73.4/47.4
	4030017650	S.CER C1005 CH 1H 270J-T	[FRA]	
	4030017650	S.CER C1005 CH 1H 270J-T	[ESP]	
	4030017670	S.CER C1005 CH 1H 390J-T	[USA]	
	4030017650	S.CER C1005 CH 1H 270J-T	[EXP]	
	4030017650	S.CER C1005 CH 1H 270J-T	[ITR]	
	4030017650	S.CER C1005 CH 1H 270J-T	[UK]	
	4030017670	S.CER C1005 CH 1H 390J-T	[KOR]	
	4030017650	S.CER C1005 CH 1H 270J-T	[AUS]	
	4030017650	S.CER C1005 CH 1H 270J-T	[CHN]	
C519	4030016930	S.CER C1005 JB 1A 104K-T	B	77.0/48.5
C520	4030016930	S.CER C1005 JB 1A 104K-T	B	74.4/47.4
C521	4030018960	S.CER C3216 JB 1C 106MT-N	B	65.7/20.6
C522	4030016930	S.CER C1005 JB 1A 104K-T	B	69.7/19.9
C523	4030018970	S.CER C3225 JB 1C 226MT-N	B	53.4/28.9
C524	4030017700	S.CER C1005 CH 1H 151J-T	B	59.0/42.7
C525	4030016930	S.CER C1005 JB 1A 104K-T	B	55.4/30.3
C526	4030018090	S.CER C1005 JB 1E 822K-T	B	59.2/35.8
C527	4030018100	S.CER C1005 JB 1H 681K-T	B	59.0/46.0
C528	4030017730	S.CER C1005 JB 1H 471K-T	B	59.0/45.1
C529	4030018970	S.CER C3225 JB 1C 226MT-N	B	58.4/40.0
C530	4030016930	S.CER C1005 JB 1A 104K-T	B	77.2/39.1
C531	4030018970	S.CER C3225 JB 1C 226MT-N	B	81.3/35.9
C532	4030016930	S.CER C1005 JB 1A 104K-T	B	77.2/36.6
C533	4030017490	S.CER C1608 JB 1A 105K-T	B	77.1/44.5
C534	4030016970	S.CER C1005 JB 1E 223K-T	B	77.5/42.5
C536	4610001850	S.TRI TZB4R200AB10R00 (TZBX4R200BA110)	B	81.0/39.7
C537	4030016930	S.CER C1005 JB 1A 104K-T	B	77.2/40.1
C538	4030016930	S.CER C1005 JB 1A 104K-T	B	77.2/37.6
C539	4030018910	S.CER C1608 JB 0J 475K-T	B	77.7/34.9
C540	4030018910	S.CER C1608 JB 0J 475K-T	B	58.5/37.0
C541	4030018970	S.CER C3225 JB 1C 226MT-N	B	59.2/28.9
C542	4030018910	S.CER C1608 JB 0J 475K-T	B	77.7/33.6
C543	4030018960	S.CER C3216 JB 1C 106MT-N	B	80.0/46.6
C544	4030018910	S.CER C1608 JB 0J 475K-T	B	77.7/32.3
C545	4030011600	S.CER C1608 JB 1E 104K-T	B	77.0/46.4
C549	4030018960	S.CER C3216 JB 1C 106MT-N	B	71.7/28.8
C550	4030018960	S.CER C3216 JB 1C 106MT-N	B	77.1/28.8
C551	4030018960	S.CER C3216 JB 1C 106MT-N	B	73.8/28.8
C559	4030017460	S.CER C1005 JB 1H 102K-T	B	29.4/43.9
C560	4030018960	S.CER C3216 JB 1C 106MT-N	B	17.0/33.2
C561	4030017330	S.CER C1005 JF 1C 104Z-T	B	7.3/30.8
C562	4030017780	S.CER C1005 JB 1H 472K-T	B	6.1/30.9
C601	4030016930	S.CER C1005 JB 1A 104K-T	B	73.6/24.9
C602	4030016930	S.CER C1005 JB 1A 104K-T	B	48.8/43.5
C603	4030016930	S.CER C1005 JB 1A 104K-T	B	55.0/39.4
C604	4030018960	S.CER C3216 JB 1C 106MT-N	B	55.8/36.3
C605	4030016930	S.CER C1005 JB 1A 104K-T	B	50.9/48.0
C606	4030018960	S.CER C3216 JB 1C 106MT-N	B	49.1/47.5
C607	4030011600	S.CER C1608 JB 1E 104K-T	B	55.5/40.6
C608	4030018960	S.CER C3216 JB 1C 106MT-N	B	55.8/43.7
C609	4030011600	S.CER C1608 JB 1E 104K-T	B	50.6/31.7
C610	4030018960	S.CER C3216 JB 1C 106MT-N	B	52.3/33.5
C611	4550007220	S.TAN F931A476MCMCMBMA	B	73.5/22.1
C651	4030018960	S.CER C3216 JB 1C 106MT-N	B	16.9/17.6
C652	4030018960	S.CER C3216 JB 1C 106MT-N	B	6.7/17.1
C653	4030011600	S.CER C1608 JB 1E 104K-T	B	15.8/19.3
C654	4030017490	S.CER C1608 JB 1A 105K-T	B	3.5/20.4
C655	4030016790	S.CER C1005 JB 1E 103K-T	B	0.8/30.3
C656	4030019090	S.CER C2012 JB 1C 225M-T	B	7.8/25.6
C657	4030018520	S.CER C1608 JB 0J 225M-T	B	7.0/20.6
C658	4030017650	S.CER C1005 CH 1H 270J-T	B	5.5/20.6
C659	4030017780	S.CER C1005 JB 1H 472K-T	B	15.3/20.4
C701	4030018960	S.CER C3216 JB 1C 106MT-N	B	4.7/32.5
C702	4030018960	S.CER C3216 JB 1C 106MT-N	B	49.0/19.1
C801	4030016930	S.CER C1005 JB 1A 104K-T	B	63.0/19.8
C802	4030011600	S.CER C1608 JB 1E 104K-T	B	21.6/48.6
C851	4030017780	S.CER C1005 JB 1H 472K-T	B	32.1/23.9
C852	4030018960	S.CER C3216 JB 1C 106MT-N	B	40.3/15.9
C853	4030016930	S.CER C1005 JB 1A 104K-T	B	43.2/27.6
C2001	4030018520	S.CER C1608 JB 0J 225M-T	B	78.5/16.7
C2002	4030017780	S.CER C1005 JB 1H 472K-T	T	114.8/34.7
C2003	4030017630	S.CER C1005 CH 1H 120J-T	B	103.3/28.7
C2004	4030017630	S.CER C1005 CH 1H 120J-T	B	103.3/25.1
C2005	4030016790	S.CER C1005 JB 1E 103K-T	B	103.3/34.9
C2006	4030016930	S.CER C1005 JB 1A 104K-T	B	98.0/37.9
C2007	4030018960	S.CER C3216 JB 1C 106MT-N	B	105.8/47.7
C2008	4030017030	S.CER C1005 JB 1A 273K-T	B	109.7/44.6

[DISPLAY UNIT]

REF NO.	PARTS NO.	DESCRIPTION	M.	H/V LOCATION
C2009	4030016930	S.CER C1005 JB 1A 104K-T	B	99.0/37.9
C2010	4030016930	S.CER C1005 JB 1A 104K-T	B	100.0/37.9
C2011	4030016930	S.CER C1005 JB 1A 104K-T	B	78.7/29.9
C2012	4030017780	S.CER C1005 JB 1H 472K-T	B	95.8/37.9
C2013	4030017780	S.CER C1005 JB 1H 472K-T	B	93.1/37.9
C2014	4030016930	S.CER C1005 JB 1A 104K-T	T	110.4/41.7
C2015	4030016930	S.CER C1005 JB 1A 104K-T	B	103.1/35.8
C2016	4030016930	S.CER C1005 JB 1A 104K-T	B	82.8/28.5
J202	6510023801	S.CON S4B-ZR-SM4A-TF(LF)(SN)	B	115.9/39.4
J251	6510025771	S.CON 03-935H1-72BKA	B	154.2/45.8
J303	6510021431	S.CON S8B-ZR-SM4A-TF(LF)(SN)	B	115.9/20.9
J401	6510024840	S.CON 52746-1070	B	21.3/26.3
J601	6510024780	S.CON 52437-2472	B	45.1/42.1
J2001	6510024790	S.CON 52559-1072	B	96.9/47.6
DS805	5040003190	S.LED NSSW008B	T	29.5/39.5
DS806	5040003190	S.LED NSSW008B	T	29.5/31.5
DS807	5040003190	S.LED NSSW008B	T	29.5/24.2
DS808	5040003190	S.LED NSSW008B	T	29.5/16.2
DS2001	5040002930	S.LED SML-512MW T86	T	110.3/15.8
DS2002	5040002200	S.LED CL-170UR-CD-T	T	110.3/36.8
DS2004	5040002930	S.LED SML-512MW T86	T	11.5/20.6
S201	2230001160	S.SWI SPVP110100	T	157.4/34.3
S251	2220000330	S.SWI HSW0880-01-210	B	139.7/46.6
S701	2230001150	S.SWI LS9J2M-1FG-T	T	22.2/48.3
S702	2230001150	S.SWI LS9J2M-1FG-T	T	21.7/36.5
S703	2230001150	S.SWI LS9J2M-1FG-T	T	20.9/17.0
S704	2230001150	S.SWI LS9J2M-1FG-T	T	21.6/2.7
S721	2230001150	S.SWI LS9J2M-1FG-T	T	40.2/2.4
S722	2230001150	S.SWI LS9J2M-1FG-T	T	54.3/2.4
S723	2230001150	S.SWI LS9J2M-1FG-T	T	68.5/2.4
S724	2230001150	S.SWI LS9J2M-1FG-T	T	82.6/2.4
S741	2230001150	S.SWI LS9J2M-1FG-T	T	98.1/47.9
S742	2230001150	S.SWI LS9J2M-1FG-T	T	99.1/32.1
S743	2230001150	S.SWI LS9J2M-1FG-T	T	99.1/20.5
S744	2230001150	S.SWI LS9J2M-1FG-T	T	98.1/5.8
S761	2230001150	S.SWI LS9J2M-1FG-T	T	109.5/49.1
S762	2230001150	S.SWI LS9J2M-1FG-T	T	109.5/3.5
S763	2230001150	S.SWI LS9J2M-1FG-T	T	154.9/47.5
S764	2230001150	S.SWI LS9J2M-1FG-T	T	154.9/5.2
S781	2230001150	S.SWI LS9J2M-1FG-T	T	4.6/29.1
S782	2230001150	S.SWI LS9J2M-1FG-T	T	21.7/25.8
EP1	6910014730	S.BEA MPZ2012S331A-T	B	64.2/6.7

M.=Mounted side (T: Mounted on the Top side, B: Mounted on the Bottom side)
S.=Surface mount

[VR UNIT]

REF NO.	PARTS NO.	DESCRIPTION	M.	H/V LOCATION
R1	7210003230	VAR TP96D00A-17F-10KBX2-2427	T	1.3/32.6
R2	7030003860	S.RES ERJ3GE JPW V	T	2.3/30.0
R3	7030003860	S.RES ERJ3GE JPW V	T	
J1	6510024850	S.CON 54550-1094	T	3.4/22.3
S1	2250000170	ENC TP90D96AE20-17F (1352)		
EP4	6910012350	S.BEA MMZ1608Y 102BT	T	2.7/32.6
EP5	6910012350	S.BEA MMZ1608Y 102BT	T	3.7/30.0
EP6	6910012350	S.BEA MMZ1608Y 102BT	T	0.9/30.0
EP7	6910012350	S.BEA MMZ1608Y 102BT	T	0.9/14.5
EP8	6910012350	S.BEA MMZ1608Y 102BT	T	3.7/14.5
EP9	6910012350	S.BEA MMZ1608Y 102BT	T	2.7/11.8
EP10	6910012350	S.BEA MMZ1608Y 102BT	T	2.3/14.5
EP11	6910012350	S.BEA MMZ1608Y 102BT	T	1.3/11.8

[LOGIC UNIT]

REF NO.	PARTS NO.	DESCRIPTION	M.	H/V LOCATION
IC1	1130013281	S.IC TC58FVM6T5BTG65GCT (2427D-6)	T	28.0/30.2
IC2	1130011151	S.IC SN74AHC2G08HDCT3	B	40.3/38.3
IC3	1130011151	S.IC SN74AHC2G08HDCT3	B	40.7/32.5
IC4	1130012600	S.IC SN74AHC1G04DCKR	B	43.6/33.8
IC51	1130012842	S.IC CY7C1021DV33-10BVXIT	B	24.5/28.6
IC301	1140012541	S.IC ADSP-BF532SBBCZ400 <FE>	B	28.6/39.2
IC401	1110004770	S.IC BU9480F-E2	B	17.5/21.6
IC451	1110006570	S.IC TS462CPT	B	29.2/7.9
IC452	1110006570	S.IC TS462CPT	T	39.2/8.5
IC502	1110006570	S.IC TS462CPT	T	30.7/5.4
IC551	1190001611	S.IC AK4528VFP-E2/P	T	17.9/8.1
IC601	1110006570	S.IC TS462CPT	B	12.7/10.8
IC701	1130012600	S.IC SN74AHC1G04DCKR	B	2.7/15.9
IC1201	1130012792	S.IC CY22150KFZXCCT	B	44.6/4.6
IC1212	1140012170	S.IC BH7236AF-E2	T	57.7/7.3
IC1217	1130007181	S.IC TC7WU04FU(TE12LF)	B	63.5/9.9
IC1218	1130012761	S.IC SN74AHC2G86HDCT3	B	52.7/6.6
IC1226	1130010871	S.IC S1D13706F00A200	B	53.8/19.9
IC1251	1180002020	S.REG BA033FP-E2	T	79.5/5.2
IC1301	1130012691	S.IC R1EX24256ASA00A	T	81.4/36.2
IC1302	1140013137	S.IC HD6432375A23FQV(SX-2427B-7)	T	54.9/25.2
IC1303	1110005771	S.IC S-80942CNMC-G9CT2G	T	81.2/10.4
IC1304	1130011551	S.IC RX-4581NB-F	B	71.9/7.3
IC1402	1130012781	S.IC SN74AHC2G04HDCT3	T	79.1/18.9
IC2002	1130012842	S.IC CY7C1021DV33-10BVXIT	B	32.7/28.4
IC2101	1130012850	S.IC SN74LVC3G34DCUR	T	44.5/44.8
IC2102	1130012850	S.IC SN74LVC3G34DCUR	T	44.5/41.3
IC2201	1140012541	S.IC ADSP-BF532SBBCZ400 <FE>	B	28.6/17.7
Q201	1550000110	S.FET RTQ035P02TR	B	18.9/42.7
Q1101	1530002060	S.TRA 2SC4081 T106 R	T	82.2/20.4
Q1102	1590003940	S.TRA RN1105(TE85LF)	T	81.9/22.8
Q1103	1510000510	S.TRA 2SA1576A T106R	T	81.9/16.4
Q1201	1590003940	S.TRA RN1105(TE85LF)	T	44.8/13.3
D201	1750001280	S.DIO CUS02(TE85LQ)	B	19.2/45.3
D1001	1750000370	S.DIO DA221 TL	B	64.6/36.9
D1002	1750000370	S.DIO DA221 TL	B	65.0/34.6
D1101	1790001251	S.DIO MA2S1110GL	T	82.0/18.4
D1106	1750000951	S.DIO MA2J7320GL	T	80.1/29.7
D1107	1790001670	S.DIO RB706F-40T106	T	82.4/31.4
D1110	1790001670	S.DIO RB706F-40T106	T	75.8/32.4
D1111	1790001670	S.DIO RB706F-40T106	T	75.3/29.4
D1112	1790001670	S.DIO RB706F-40T106	B	79.2/29.2
D1113	1790001670	S.DIO RB706F-40T106	B	82.4/30.7
D1201	1790001251	S.DIO MA2S1110GL	B	83.0/40.5
D1301	1790000661	S.DIO MA2J7280GL	B	77.6/2.9
D1304	1750000370	S.DIO DA221 TL	T	76.1/19.9
D1305	1750000370	S.DIO DA221 TL	T	75.9/16.8
D1306	1750000370	S.DIO DA221 TL	B	49.3/32.9
D1307	1750000370	S.DIO DA221 TL	B	51.4/33.3
D1311	1790001251	S.DIO MA2S1110GL	B	81.0/19.7
D1312	1790001251	S.DIO MA2S1110GL	B	83.1/18.6
D1313	1790001251	S.DIO MA2S1110GL	B	80.1/22.7
D1314	1790001241	S.DIO MA2S7280GL	B	81.7/22.5
D1331	1790001251	S.DIO MA2S1110GL	B	65.6/17.5
X1201	6050012150	S.XTA CR-806 SMD-49TA 4.433619 MHz <KDS> [EUR]	B	61.4/3.1
	6050012150	S.XTA CR-806 SMD-49TA 4.433619 MHz <KDS> [FRA]		
	6050012150	S.XTA CR-806 SMD-49TA 4.433619 MHz <KDS> [ESP]		
	6050012140	S.XTA CR-805 SMD-49TA 3.579545 MHz <KDS> [USA]		
	6050012150	S.XTA CR-806 SMD-49TA 4.433619 MHz <KDS> [EXP]		
	6050012150	S.XTA CR-806 SMD-49TA 4.433619 MHz <KDS> [ITR]		
	6050012150	S.XTA CR-806 SMD-49TA 4.433619 MHz <KDS> [UK]		
	6050012140	S.XTA CR-805 SMD-49TA 3.579545 MHz <KDS> [KOR]		
	6050012150	S.XTA CR-806 SMD-49TA 4.433619 MHz <KDS> [AUS]		
	6050012150	S.XTA CR-806 SMD-49TA 4.433619 MHz <KDS> [CHN]		
X1301	6050012190	S.XTA CR-809 SMD-49TA 15.39744 MHz <KDS>	B	60.5/30.8
L201	6200011900	S.COI LQH43CN100K03L	T	16.0/42.0
L202	6200009491	S.COI CDRH6D28NP-100NCI	B	13.3/42.3
L551	6200005011	S.COI NLV25T-100J	T	11.2/10.5
L552	6200005011	S.COI NLV25T-100J	T	11.2/5.9
L1202	6200002041	S.COI NLV25T-101J	B	52.4/2.3
L1203	6200002041	S.COI NLV25T-101J	T	66.7/3.5
L1204	6200002041	S.COI NLV25T-101J	B	58.0/10.4
L2101	6200005011	S.COI NLV25T-100J	T	41.0/45.1
L2102	6200005011	S.COI NLV25T-100J	T	40.3/41.6
R2	7030005090	S.RES ERJ2GEJ 104 X (100K)	T	39.6/30.2
R3	7030005090	S.RES ERJ2GEJ 104 X (100K)	T	39.6/32.3

M.=Mounted side (T: Mounted on the Top side, B: Mounted on the Bottom side)
S.=Surface mount

[LOGIC UNIT]

REF NO.	PARTS NO.	DESCRIPTION	M.	H/V LOCATION
R4	7030005090	S.RES ERJ2GEJ 104 X (100K)	T	31.8/45.9
R5	7030005090	S.RES ERJ2GEJ 104 X (100K)	T	30.9/45.9
R6	7030005090	S.RES ERJ2GEJ 104 X (100K)	T	30.0/45.9
R203	7030000010	S.RES MCR10EZHJ JPW (000)	T	20.8/45.7
R301	7030004980	S.RES ERJ2GEJ 101 X (100)	T	25.4/45.9
R302	7030005050	S.RES ERJ2GEJ 103 X (10K)	T	26.9/45.9
R303	7030005050	S.RES ERJ2GEJ 103 X (10K)	T	27.8/45.9
R306	7030005050	S.RES ERJ2GEJ 103 X (10K)	B	38.2/31.2
R307	7030005050	S.RES ERJ2GEJ 103 X (10K)	T	22.1/41.4
R308	7030005050	S.RES ERJ2GEJ 103 X (10K)	T	22.1/40.5
R310	7030005050	S.RES ERJ2GEJ 103 X (10K)	B	35.4/38.0
R312	7030010040	S.RES ERJ2GEJ-JPW	B	33.7/46.0
R313	7030010040	S.RES ERJ2GEJ-JPW	B	35.6/43.3
R314	7030010040	S.RES ERJ2GEJ-JPW	B	35.6/40.6
R413	7030004980	S.RES ERJ2GEJ 101 X (100)	B	18.2/16.8
R414	7030004980	S.RES ERJ2GEJ 101 X (100)	T	16.3/19.9
R415	7030004980	S.RES ERJ2GEJ 101 X (100)	B	19.1/16.8
R416	7030004980	S.RES ERJ2GEJ 101 X (100)	B	17.3/16.8
R462	7030004980	S.RES ERJ2GEJ 101 X (100)	B	33.8/7.4
R463	7030004980	S.RES ERJ2GEJ 101 X (100)	B	43.6/8.8
R464	7030004980	S.RES ERJ2GEJ 101 X (100)	B	26.2/5.7
R465	7030009270	S.RES ERJ2GEJ 821 X (820)	B	28.7/5.2
R467	7030004980	S.RES ERJ2GEJ 101 X (100)	B	31.4/4.3
R469	7030009270	S.RES ERJ2GEJ 821 X (820)	B	30.5/19.9
R470	7030009140	S.RES ERJ2GEJ 272 X (2.7K)	T	29.4/3.1
R471	7030009140	S.RES ERJ2GEJ 272 X (2.7K)	T	34.0/3.3
R472	7030005040	S.RES ERJ2GEJ 472 X (4.7K)	T	38.7/4.2
R473	7030005040	S.RES ERJ2GEJ 472 X (4.7K)	T	38.7/3.2
R474	7030009140	S.RES ERJ2GEJ 272 X (2.7K)	B	24.8/7.2
R475	7030009140	S.RES ERJ2GEJ 272 X (2.7K)	B	33.8/9.2
R476	7030005040	S.RES ERJ2GEJ 472 X (4.7K)	T	40.3/3.3
R507	7030004980	S.RES ERJ2GEJ 101 X (100)	T	26.1/3.6
R508	7030004980	S.RES ERJ2GEJ 101 X (100)	T	31.7/9.0
R510	7030005040	S.RES ERJ2GEJ 472 X (4.7K)	T	32.6/9.0
R511	7030005040	S.RES ERJ2GEJ 472 X (4.7K)	T	29.0/9.0
R512	7030004980	S.RES ERJ2GEJ 101 X (100)	T	29.9/9.0
R514	7030005050	S.RES ERJ2GEJ 103 X (10K)	T	34.9/8.8
R515	7030005050	S.RES ERJ2GEJ 103 X (10K)	T	34.9/7.9
R516	7030005040	S.RES ERJ2GEJ 472 X (4.7K)	T	39.1/12.8
R517	7030005040	S.RES ERJ2GEJ 472 X (4.7K)	T	36.5/11.1
R518	7030009140	S.RES ERJ2GEJ 272 X (2.7K)	T	36.5/5.7
R519	7030009140	S.RES ERJ2GEJ 272 X (2.7K)	T	26.5/5.7
R520	7030005040	S.RES ERJ2GEJ 472 X (4.7K)	T	41.4/12.8
R551	7030004980	S.RES ERJ2GEJ 101 X (100)	T	16.6/13.5
R553	7030004980	S.RES ERJ2GEJ 101 X (100)	T	14.8/13.5
R554	7030005090	S.RES ERJ2GEJ 104 X (100K)	T	15.5/3.3
R568	7030004980	S.RES ERJ2GEJ 101 X (100)	T	13.0/13.5
R569	7030004980	S.RES ERJ2GEJ 101 X (100)	T	15.7/13.5
R570	7030004980	S.RES ERJ2GEJ 101 X (100)	T	13.9/13.5
R571	7030009320	S.RES ERJ2GEJ 4R7 X (4.7)	B	20.7/8.4
R601	7030004980	S.RES ERJ2GEJ 101 X (100)	T	3.1/12.4
R602	7030007300	S.RES ERJ2GEJ 332 X (3.3K)	T	11.9/8.5
R603	7030005040	S.RES ERJ2GEJ 472 X (4.7K)	B	12.4/4.9
R604	7030005040	S.RES ERJ2GEJ 472 X (4.7K)	B	13.3/4.9
R605	7030007300	S.RES ERJ2GEJ 332 X (3.3K)	B	14.5/5.2
R606	7030007300	S.RES ERJ2GEJ 332 X (3.3K)	B	12.9/7.3
R607	7030005290	S.RES ERJ2GEJ 682 X (6.8K)	B	13.9/3.7
R608	7030005290	S.RES ERJ2GEJ 682 X (6.8K)	B	14.9/6.5
R609	7030005040	S.RES ERJ2GEJ 472 X (4.7K)	T	11.0/8.5
R610	7030005040	S.RES ERJ2GEJ 472 X (4.7K)	B	9.0/4.3
R611	7030005040	S.RES ERJ2GEJ 472 X (4.7K)	B	9.9/4.3
R612	7030007300	S.RES ERJ2GEJ 332 X (3.3K)	B	11.5/5.7
R613	7030007300	S.RES ERJ2GEJ 332 X (3.3K)	B	8.9/7.0
R614	7030005290	S.RES ERJ2GEJ 682 X (6.8K)	B	9.8/7.0
R615	7030005290	S.RES ERJ2GEJ 682 X (6.8K)	B	10.7/7.0
R618	7030005120	S.RES ERJ2GEJ 102 X (1K)	B	14.5/4.3
R619	7030005120	S.RES ERJ2GEJ 102 X (1K)	B	10.8/4.3
R701	7030005050	S.RES ERJ2GEJ 103 X (10K)	B	4.6/22.2
R702	7030005050	S.RES ERJ2GEJ 103 X (10K)	B	4.6/23.7
R703	7030005050	S.RES ERJ2GEJ 103 X (10K)	B	4.5/25.9
R705	7030005120	S.RES ERJ2GEJ 102 X (1K)	B	5.0/21.0
R706	7030005050	S.RES ERJ2GEJ 103 X (10K)	B	4.5/17.2
R707	7030007250	S.RES ERJ2GEJ 220 X (22K)	B	4.5/15.5
R1001	7030005120	S.RES ERJ2GEJ 102 X (1K)	B	70.9/37.0
R1002	7030005050	S.RES ERJ2GEJ 103 X (10K)	B	66.0/32.4
R1003	7030005160	S.RES ERJ2GEJ 105 X (1M)	B	70.4/35.8
R1004	7030005240	S.RES ERJ2GEJ 473 X (47K)	B	66.2/18.6
R1006	7030005120	S.RES ERJ2GEJ 102 X (1K)	B	52.0/34.9
R1007	7030005120	S.RES ERJ2GEJ 102 X (1K)	B	53.2/32.0
R1008	7030005120	S.RES ERJ2GEJ 102 X (1K)	B	75.1/20.5
R1010	7030005240	S.RES ERJ2GEJ 473 X (47K)	B	76.8/19.9
R1012	7030005000	S.RES ERJ2GEJ 471 X (470)	B	66.5/34.0
R1013	7030005000	S.RES ERJ2GEJ 471 X (470)	B	66.5/36.5
R1015	7030005240	S.RES ERJ2GEJ 473 X (47K)	B	50.4/34.9
R1016	7030005240	S.RES ERJ2GEJ 473 X (47K)	B	51.1/31.8
R1018	7030007340	S.RES ERJ2GEJ 153 X (15K)	B	63.4/34.5
R1019	7030007340	S.RES ERJ2GEJ 153 X (15K)	B	63.0/36.1
R1101	7030008290	S.RES ERJ2GEJ 183 X (18K)	T	80.1/15.5
R1102	7030008010	S.RES ERJ2GEJ 123 X (12K)	T	80.0/22.0
R1103	7030005120	S.RES ERJ2GEJ 102 X (1K)	T	80.0/22.9
R1104	7030005120	S.RES ERJ2GEJ 102 X (1K)	T	74.6/20.7
R1105	7030005050	S.RES ERJ2GEJ 103 X (10K)	T	79.7/14.3
R1106	7030005240	S.RES ERJ2GEJ 473 X (47K)	T	83.4/14.4
R1107	7030005090	S.RES ERJ2GEJ 104 X (100K)	T	79.2/15.5
R1108	7030005090	S.RES ERJ2GEJ 104 X (100K)	T	78.3/14.9
R1109	7030005160	S.RES ERJ2GEJ 105 X (1M)	T	78.4/22.0
R1110	7030005240	S.RES ERJ2GEJ 473 X (47K)	T	76.8/21.5
R1111	7030005090	S.RES ERJ2GEJ 104 X (100K)	T	77.4/14.9

[LOGIC UNIT]

REF NO.	PARTS NO.	DESCRIPTION	M.	H/V LOCATION
R1113	7030007290	S.RES ERJ2GEJ 222 X (2.2K)	T	83.2/29.4
R1114	7030007300	S.RES ERJ2GEJ 332 X (3.3K)	T	82.3/29.4
R1115	7030005120	S.RES ERJ2GEJ 102 X (1K)	T	76.8/26.3
R1116	7030005120	S.RES ERJ2GEJ 102 X (1K)	T	77.0/28.2
R1117	7030005120	S.RES ERJ2GEJ 102 X (1K)	B	82.8/22.3
R1118	7030007300	S.RES ERJ2GEJ 332 X (3.3K)	B	83.1/23.9
R1119	7030007300	S.RES ERJ2GEJ 332 X (3.3K)	B	83.9/22.3
R1120	7030005120	S.RES ERJ2GEJ 102 X (1K)	B	84.2/23.9
R1123	7030005160	S.RES ERJ2GEJ 105 X (1M)	B	66.9/24.5
R1124	7030005120	S.RES ERJ2GEJ 102 X (1K)	B	82.0/20.0
R1126	7030005160	S.RES ERJ2GEJ 105 X (1M)	B	66.9/23.6
R1127	7030010040	S.RES ERJ2GEJ-JPW	T	73.7/18.5
R1128	7030005120	S.RES ERJ2GEJ 102 X (1K)	B	83.3/20.2
R1129	7030007300	S.RES ERJ2GEJ 332 X (3.3K)	B	82.0/28.4
R1131	7030005090	S.RES ERJ2GEJ 104 X (100K)	B	78.6/26.2
R1132	7030005090	S.RES ERJ2GEJ 104 X (100K)	B	81.4/24.5
R1201	7030005160	S.RES ERJ2GEJ 105 X (1M)	B	62.8/7.7
R1202	7030005050	S.RES ERJ2GEJ 103 X (10K)	B	49.2/7.5
R1203	7030005050	S.RES ERJ2GEJ 103 X (10K)	B	49.2/8.4
R1204	7030005050	S.RES ERJ2GEJ 103 X (10K)	B	49.7/9.6
R1205	7030010040	S.RES ERJ2GEJ-JPW	B	49.2/3.2
R1206	7030007570	S.RES ERJ2GEJ 122 X (1.2K)	B	46.1/9.6
R1207	7030007570	S.RES ERJ2GEJ 122 X (1.2K)	B	44.0/9.6
R1208	7030007570	S.RES ERJ2GEJ 122 X (1.2K)	B	43.5/11.4
R1209	7030009710	S.RES ERJ2GEJ 203 X (20K)	B	48.8/9.6
R1210	7030007350	S.RES ERJ2GEJ 393 X (39K)	B	47.9/9.6
R1211	7030005050	S.RES ERJ2GEJ 103 X (10K)	B	48.9/11.4
R1212	7030005050	S.RES ERJ2GEJ 103 X (10K)	B	48.0/11.4
R1213	7030005050	S.RES ERJ2GEJ 103 X (10K)	B	47.1/11.4
R1214	7030009710	S.RES ERJ2GEJ 203 X (20K)	B	46.2/11.4
R1215	7030007350	S.RES ERJ2GEJ 393 X (39K)	B	45.3/11.4
R1216	7030005050	S.RES ERJ2GEJ 103 X (10K)	B	44.7/12.6
R1217	7030005050	S.RES ERJ2GEJ 103 X (10K)	B	44.7/13.5
R1218	7030005050	S.RES ERJ2GEJ 103 X (10K)	B	44.7/14.4
R1219	7030005040	S.RES ERJ2GEJ 472 X (4.7K)	B	74.4/41.2
R1220	7030009710	S.RES ERJ2GEJ 203 X (20K)	B	44.7/15.3
R1221	7030005040	S.RES ERJ2GEJ 472 X (4.7K)	B	83.0/41.6
R1222	7030005040	S.RES ERJ2GEJ 472 X (4.7K)	B	74.4/40.3
R1223	7030005040	S.RES ERJ2GEJ 472 X (4.7K)	B	74.4/39.3
R1224	7030005040	S.RES ERJ2GEJ 472 X (4.7K)	B	83.0/39.4
R1225	7030005240	S.RES ERJ2GEJ 473 X (47K)	B	83.1/35.7
R1226	7030005240	S.RES ERJ2GEJ 473 X (47K)	B	74.4/37.6
R1227	7030005240	S.RES ERJ2GEJ 473 X (47K)	B	73.8/38.5
R1228	7030005240	S.RES ERJ2GEJ 473 X (47K)	B	82.2/35.4
R1229	7030007350	S.RES ERJ2GEJ 393 X (39K)	B	43.5/15.7
R1230	7030004970	S.RES ERJ2GEJ 470 X (47)	B	49.2/2.3
R1231	7030005050	S.RES ERJ2GEJ 103 X (10K)	B	48.8/5.4
R1232	7030005220	S.RES ERJ2GEJ 223 X (22K)	B	40.0/3.3
R1235	7030007270	S.RES ERJ2GEJ 151 X (150)	T	66.2/5.9
R1236	7030007270	S.RES ERJ2GEJ 151 X (150)	T	66.2/7.0
R1237	7030007290	S.RES ERJ2GEJ 222 X (2.2K)	B	61.2/7.7
R1251	7030011250	S.RES ERJ1TY 390U (39)	T	70.3/6.4
R1301	7030005220	S.RES ERJ2GEJ 223 X (22K)	T	78.2/37.9
R1302	7030005050	S.RES ERJ2GEJ 103 X (10K)	T	78.2/36.1
R1303	7030005240	S.RES ERJ2GEJ 473 X (47K)	B	66.1/21.3
R1304	7030005240	S.RES ERJ2GEJ 473 X (47K)	B	66.1/20.4
R1305	7030009160	S.RES ERJ2GEJ 181 X (180)	T	68.6/26.0
R1306	7030005060	S.RES ERJ2GEJ 333 X (33K)	T	78.8/11.5
R1307	7030005040	S.RES ERJ2GEJ 472 X (4.7K)	T	68.0/22.0
R1308	7030005110	S.RES ERJ2GEJ 224 X (220K)	T	67.6/20.1
R1309	7030005110	S.RES ERJ2GEJ 224 X (220K)	T	69.1/19.5
R1310	7030005110	S.RES ERJ2GEJ 224 X (220K)	T	67.6/18.9
R1311	7030005110	S.RES ERJ2GEJ 224 X (220K)	T	69.1/18.3
R1312	7030005110	S.RES ERJ2GEJ 224 X (220K)	T	67.6/17.7
R1313	7030005110	S.RES ERJ2GEJ 224 X (220K)	T	69.1/17.1
R1314	7030005110	S.RES ERJ2GEJ 224 X (220K)	T	67.6/16.5
R1315	7030005110	S.RES ERJ2GEJ 224 X (220K)	T	69.1/15.9
R1316	7030005110	S.RES ERJ2GEJ 224 X (220K)	B	66.6/12.4
R1317	7030005110	S.RES ERJ2GEJ 224 X (220K)	B	65.7/12.4
R1318	7030005110	S.RES ERJ2GEJ 224 X (220K)	B	64.8/12.4
R1319	7030005110	S.RES ERJ2GEJ 224 X (220K)	B	63.9/12.4
R1320	7030005110	S.RES ERJ2GEJ 224 X (220K)	B	63.0/12.4
R1321	7030005110	S.RES ERJ2GEJ 224 X (220K)	B	62.1/12.4
R1322	7030005110	S.RES ERJ2GEJ 224 X (220K)	B	61.2/12.4
R1323	7030005110	S.RES ERJ2GEJ 224 X (220K)	B	60.3/12.2
R1324	7030005050	S.RES ERJ2GEJ 103 X (10K)	T	80.5/12.6
R1325	7030007350	S.RES ERJ2GEJ 393 X (39K)	T	78.2/9.9
R1326	7030005010	S.RES ERJ2GEJ 681 X (680)	B	79.0/2.1
R1327	7030005240	S.RES ERJ2GEJ 473 X (47K)	B	66.1/19.5
R1328	7030005050	S.RES ERJ2GEJ 103 X (10K)	B	75.9/6.4
R1329	7030005240	S.RES ERJ2GEJ 473 X (47K)	B	75.9/5.0
R1331	7030010040	S.RES ERJ2GEJ-JPW	B	

[LOGIC UNIT]

REF NO.	PARTS NO.	DESCRIPTION	M.	H/V LOCATION
R1410	7030005240	S.RES ERJ2GEJ 473 X (47K)	B	78.3/23.6
R1411	7030005240	S.RES ERJ2GEJ 473 X (47K)	B	76.8/24.2
R1412	7030005240	S.RES ERJ2GEJ 473 X (47K)	B	43.7/24.8
R1413	7030005240	S.RES ERJ2GEJ 473 X (47K)	T	42.5/17.4
R1502	7030007300	S.RES ERJ2GEJ 332 X (3.3K)	B	81.0/28.9
R2102	7030005050	S.RES ERJ2GEJ 103 X (10K)	T	47.8/42.8
R2103	7030005050	S.RES ERJ2GEJ 103 X (10K)	T	47.6/40.6
R2104	7030005050	S.RES ERJ2GEJ 103 X (10K)	T	47.8/43.8
R2105	7030005050	S.RES ERJ2GEJ 103 X (10K)	T	47.6/41.8
R2110	7030010040	S.RES ERJ2GEJ-JPW	B	21.5/22.5
R2112	7030005040	S.RES ERJ2GEJ 472 X (4.7K)	T	38.6/44.4
R2201	7030004980	S.RES ERJ2GEJ 101 X (100)	T	31.5/11.1
R2202	7030005050	S.RES ERJ2GEJ 103 X (10K)	T	30.6/11.1
R2203	7030005050	S.RES ERJ2GEJ 103 X (10K)	T	21.6/22.4
R2204	7030005050	S.RES ERJ2GEJ 103 X (10K)	T	35.2/15.5
R2205	7030005050	S.RES ERJ2GEJ 103 X (10K)	T	35.2/16.4
R2206	7030005050	S.RES ERJ2GEJ 103 X (10K)	T	21.6/21.5
R2214	7030005050	S.RES ERJ2GEJ 103 X (10K)	T	27.5/11.1
R2215	7030005050	S.RES ERJ2GEJ 103 X (10K)	T	28.4/11.1
R2216	7030010040	S.RES ERJ2GEJ-JPW	T	34.9/37.3
C1	4030016930	S.CER C1005 JB 1A 104K-T	T	16.9/25.2
C2	4030016930	S.CER C1005 JB 1A 104K-T	B	38.2/36.1
C3	4030016930	S.CER C1005 JB 1A 104K-T	B	39.6/29.0
C4	4030016930	S.CER C1005 JB 1A 104K-T	B	42.4/35.9
C5	4550007310	S.TAN F930J227MNMBA	T	40.8/23.5
C51	4030016930	S.CER C1005 JB 1A 104K-T	B	19.3/27.5
C52	4030016930	S.CER C1005 JB 1A 104K-T	B	19.3/28.4
C53	4550007310	S.TAN F930J227MNMBA	B	11.4/30.3
C54	4550007310	S.TAN F930J227MNMBA	T	7.2/8.1
C201	4030016930	S.CER C1005 JB 1A 104K-T	B	19.1/40.3
C203	4030018960	S.CER C3216 JB 1C 106MT-N	T	18.8/45.5
C204	4030016930	S.CER C1005 JB 1A 104K-T	T	12.0/40.2
C205	4030016930	S.CER C1005 JB 1A 104K-T	T	12.0/41.8
C206	4030016930	S.CER C1005 JB 1A 104K-T	B	8.9/43.5
C207	4030019460	S.CER C1608 JB 0J 106M-T	T	9.9/45.0
C302	4030016930	S.CER C1005 JB 1A 104K-T	T	30.3/40.5
C303	4030016930	S.CER C1005 JB 1A 104K-T	T	30.5/37.9
C304	4030016930	S.CER C1005 JB 1A 104K-T	T	27.0/37.3
C305	4030016930	S.CER C1005 JB 1A 104K-T	T	34.1/45.9
C306	4030016930	S.CER C1005 JB 1A 104K-T	T	29.3/37.3
C307	4030016930	S.CER C1005 JB 1A 104K-T	B	38.3/35.1
C308	4030016930	S.CER C1005 JB 1A 104K-T	T	27.4/39.4
C309	4030016930	S.CER C1005 JB 1A 104K-T	T	30.7/39.2
C310	4030016930	S.CER C1005 JB 1A 104K-T	T	24.5/45.9
C311	4030016930	S.CER C1005 JB 1A 104K-T	T	22.9/40.2
C312	4030016930	S.CER C1005 JB 1A 104K-T	T	22.0/39.6
C313	4030016930	S.CER C1005 JB 1A 104K-T	T	29.1/45.9
C314	4030016930	S.CER C1005 JB 1A 104K-T	T	27.4/38.5
C316	4030016930	S.CER C1005 JB 1A 104K-T	T	30.5/37.0
C317	4030016930	S.CER C1005 JB 1A 104K-T	T	27.0/40.6
C318	4030016930	S.CER C1005 JB 1A 104K-T	T	31.2/40.5
C319	4030016930	S.CER C1005 JB 1A 104K-T	T	29.4/40.5
C320	4030016930	S.CER C1005 JB 1A 104K-T	T	27.9/37.3
C413	4030018960	S.CER C3216 JB 1C 106MT-N	B	21.3/19.7
C414	4030016930	S.CER C1005 JB 1A 104K-T	B	16.4/16.8
C415	4030018960	S.CER C3216 JB 1C 106MT-N	B	15.6/26.4
C461	4030016930	S.CER C1005 JB 1A 104K-T	B	34.2/4.3
C462	4030018960	S.CER C3216 JB 1C 106MT-N	B	35.3/5.9
C463	4030018960	S.CER C3216 JB 1C 106MT-N	T	42.1/8.8
C464	4030016930	S.CER C1005 JB 1A 104K-T	T	43.6/10.4
C465	4030017740	S.CER C1005 JB 1H 821K-T	B	27.5/5.5
C466	4030017760	S.CER C1005 JB 1H 222K-T	B	29.6/4.3
C467	4030017740	S.CER C1005 JB 1H 821K-T	B	30.8/5.5
C468	4030018560	S.CER C2012 JB 1A 475K-T	T	31.9/2.7
C469	4030016930	S.CER C1005 JB 1A 104K-T	B	24.8/8.8
C470	4030016930	S.CER C1005 JB 1A 104K-T	B	33.8/8.3
C471	4030018560	S.CER C2012 JB 1A 475K-T	T	36.2/4.3
C472	4030018560	S.CER C2012 JB 1A 475K-T	T	36.2/2.5
C473	4030016930	S.CER C1005 JB 1A 104K-T	T	40.3/4.2
C509	4030018960	S.CER C3216 JB 1C 106MT-N	T	24.3/5.6
C510	4030016930	S.CER C1005 JB 1A 104K-T	T	26.1/4.5
C511	4030017760	S.CER C1005 JB 1H 222K-T	T	30.8/9.0
C512	4030017690	S.CER C1005 CH 1H 121J-T	T	32.1/7.8
C513	4030017690	S.CER C1005 CH 1H 121J-T	T	29.4/7.8
C514	4030016930	S.CER C1005 JB 1A 104K-T	T	36.5/6.6
C515	4030018860	S.CER C1005 JB 0J 105K-T	T	36.5/9.3
C516	4030018860	S.CER C1005 JB 0J 105K-T	T	36.5/8.4
C517	4030018860	S.CER C1005 JB 0J 105K-T	T	36.5/10.2
C518	4030016930	S.CER C1005 JB 1A 104K-T	T	26.2/6.9
C519	4030016930	S.CER C1005 JB 1A 104K-T	T	41.4/11.9
C522	4030017780	S.CER C1005 JB 1H 472K-T	B	39.0/9.9
C523	4030017780	S.CER C1005 JB 1H 472K-T	B	38.1/2.9
C524	4030017780	S.CER C1005 JB 1H 472K-T	T	3.9/2.7
C525	4030017780	S.CER C1005 JB 1H 472K-T	T	22.5/2.8
C526	4030017780	S.CER C1005 JB 1H 472K-T	T	40.0/3.9
C527	4030017780	S.CER C1005 JB 1H 472K-T	B	24.1/2.9
C551	4030018520	S.CER C1608 JB 0J 225M-T	T	20.1/13.9
C553	4030016930	S.CER C1005 JB 1A 104K-T	T	19.0/13.9
C563	4030018960	S.CER C3216 JB 1C 106MT-N	B	18.9/6.7
C564	4030016930	S.CER C1005 JB 1A 104K-T	T	18.1/13.9
C565	4030016930	S.CER C1005 JB 1A 104K-T	T	17.8/3.3
C566	4030016930	S.CER C1005 JB 1A 104K-T	T	19.4/3.3
C567	4030018960	S.CER C3216 JB 1C 106MT-N	B	21.3/12.3
C569	4030018960	S.CER C3216 JB 1C 106MT-N	B	19.2/12.3
C601	4030018960	S.CER C3216 JB 1C 106MT-N	B	3.7/12.0

[LOGIC UNIT]

REF NO.	PARTS NO.	DESCRIPTION	M.	H/V LOCATION
C602	4030016930	S.CER C1005 JB 1A 104K-T	T	4.0/11.0
C603	4030018820	S.CER C1005 JB 1H 561K-T	B	13.5/6.1
C604	4510008640	S.ELE 6 CE 100 FE	B	4.8/6.7
C605	4030016930	S.CER C1005 JB 1A 104K-T	T	10.1/8.5
C606	4030018580	S.CER C1608 CH 1H 821J-T	B	9.7/5.6
C607	4030017440	S.CER C1005 CH 1H 221J-T	B	13.4/8.5
C608	4030017440	S.CER C1005 CH 1H 221J-T	B	14.9/8.1
C609	4030018860	S.CER C1005 JB 0J 105K-T	B	15.8/14.6
C610	4030010760	S.CER C1608 CH 1H 331J-T	B	9.7/8.3
C611	4030010760	S.CER C1608 CH 1H 331J-T	B	11.8/7.8
C612	4030018960	S.CER C3216 JB 1C 106MT-N	B	7.5/13.2
C613	4550006780	S.TAN TEESVB2 0J 476M8R	B	20.6/2.8
C614	4550006780	S.TAN TEESVB2 0J 476M8R	T	3.1/6.6
C651	4030017460	S.CER C1005 JB 1H 102K-T	B	65.5/31.5
C652	4030017460	S.CER C1005 JB 1H 102K-T	B	66.0/16.5
C653	4030017460	S.CER C1005 JB 1H 102K-T	B	77.1/21.0
C654	4030017430	S.CER C1005 CH 1H 101J-T	B	77.2/28.2
C655	4030017430	S.CER C1005 CH 1H 101J-T	B	76.6/27.1
C656	4030017430	S.CER C1005 CH 1H 101J-T	B	76.2/26.2
C701	4030016930	S.CER C1005 JB 1A 104K-T	B	3.1/13.6
C702	4030017780	S.CER C1005 JB 1H 472K-T	B	4.5/18.8
C703	4030017780	S.CER C1005 JB 1H 472K-T	B	7.5/26.1
C704	4030017780	S.CER C1005 JB 1H 472K-T	B	19.8/26.2
C705	4030017430	S.CER C1005 CH 1H 101J-T	B	4.6/21.9
C706	4030017430	S.CER C1005 CH 1H 101J-T	B	4.6/24.6
C707	4030017430	S.CER C1005 CH 1H 101J-T	B	4.0/27.2
C708	4030017430	S.CER C1005 CH 1H 101J-T	B	6.6/26.1
C709	4030017430	S.CER C1005 CH 1H 101J-T	T	2.6/20.2
C711	4550007310	S.TAN F930J227MNMBA	T	5.6/19.0
C715	4030017460	S.CER C1005 JB 1H 102K-T	T	2.3/17.7
C716	4030017460	S.CER C1005 JB 1H 102K-T	T	2.3/18.7
C717	4030017460	S.CER C1005 JB 1H 102K-T	T	2.3/16.7
C1001	4030017780	S.CER C1005 JB 1H 472K-T	B	76.8/19.0
C1002	4030017780	S.CER C1005 JB 1H 472K-T	B	70.4/38.2
C1101	4030017780	S.CER C1005 JB 1H 472K-T	T	80.0/23.8
C1102	4030017780	S.CER C1005 JB 1H 472K-T	T	73.7/20.7
C1103	4030016930	S.CER C1005 JB 1A 104K-T	T	81.9/14.6
C1106	4030017780	S.CER C1005 JB 1H 472K-T	T	79.8/31.9
C1107	4030018900	S.CER C1005 JB 0J 474K-T	B	80.2/25.6
C1108	4030018900	S.CER C1005 JB 0J 474K-T	B	81.4/25.4
C1109	4030017780	S.CER C1005 JB 1H 472K-T	T	79.7/26.3
C1110	4030017780	S.CER C1005 JB 1H 472K-T	T	80.7/26.3
C1111	4030017780	S.CER C1005 JB 1H 472K-T	T	81.7/26.3
C1112	4030017780	S.CER C1005 JB 1H 472K-T	B	83.0/28.4
C1201	4030016930	S.CER C1005 JB 1A 104K-T	B	50.6/4.4
C1202	4030017780	S.CER C1005 JB 1H 472K-T	B	53.2/4.4
C1203	4030017650	S.CER C1005 CH 1H 270J-T	B	62.8/6.8
C1204	4030016930	S.CER C1005 JB 1A 104K-T	B	47.9/8.0
C1205	4030016930	S.CER C1005 JB 1A 104K-T	B	45.2/9.6
C1206	4030016930	S.CER C1005 JB 1A 104K-T	B	43.5/13.8
C1207	4030017430	S.CER C1005 CH 1H 101J-T	B	47.0/9.6
C1208	4030017430	S.CER C1005 CH 1H 101J-T	B	44.0/8.7
C1209	4030017430	S.CER C1005 CH 1H 101J-T	B	44.4/11.4
C1210	4030017650	S.CER C1005 CH 1H 270J-T	B	61.2/6.8
C1211	4030018860	S.CER C1005 JB 0J 105K-T	B	60.3/10.6
C1212	4030016930	S.CER C1005 JB 1A 104K-T	B	49.7/4.4
C1213	4030016930	S.CER C1005 JB 1A 104K-T	B	49.2/6.6
C1214	4030016930	S.CER C1005 JB 1A 104K-T	B	40.3/4.9
C1215	4030016930	S.CER C1005 JB 1A 104K-T	B	64.3/19.4
C1216	4030016930	S.CER C1005 JB 1A 104K-T	B	53.8/30.3
C1217	4030016930	S.CER C1005 JB 1A 104K-T	B	57.5/29.3
C1218	4030016930	S.CER C1005 JB 1A 104K-T	B	44.9/24.0
C1219	4030016930	S.CER C1005 JB 1A 104K-T	B	46.3/13.2
C1220	4030016930	S.CER C1005 JB 1A 104K-T	B	56.0/8.8
C1221	4030016930	S.CER C1005 JB 1A 104K-T	B	60.5/13.8
C1222	4030016930	S.CER C1005 JB 1A 104K-T	B	60.9/25.6
C1223	4030016930	S.CER C1005 JB 1A 104K-T	T	52.8/12.3
C1225	4030018960	S.CER C3216 JB 1C 106MT-N	T	66.8/10.2
C1251	4030012610	S.CER C2012 JB 1C 474K-T	T	73.5/9.4
C1252	4550007320	S.TAN F930J226MAABMA	T	73.5/4.5
C1301	4030016930	S.CER C1005 JB 1A 104K-T	T	80.2/40.3
C1302	4030018960	S.CER C3216 JB 1C 106MT-N	T	47.9/11.4
C1303	4030016790	S.CER C1005 JB 1E 103K-T	T	68.0/30.5
C1304	4030016930	S.CER C1005 JB 1A 104K-T	T	41.7/31.6
C1305	4030018960	S.CER C3216 JB 1C 106MT-N	T	44.3/37.3
C1306	4030016790	S.CER C1005 JB 1E 103K-T	T	64.1/37.6
C1307	4030016930	S.CER C1005 JB 1A 104K-T	T	48.5/13.0
C1308	4030016930	S.CER C1005 JB 1A 104K-T	T	63.2/13.2
C1309	4030016930	S.CER C1005 JB 1A 104K-T	T	46.2/37.3
C1310	4030016930	S.CER C1005 JB 1A 104K-T	T	67.1/31.0
C1311	4030016930	S.CER C1005 JB 1A 104K-T	T	67.1/25.8
C1312	403001			

[LOGIC UNIT]

REF NO.	PARTS NO.	DESCRIPTION	M.	H/V LOCATION
C2209	4030016930	S.CER C1005 JB 1A 104K-T	T	29.9/17.7
C2210	4030016930	S.CER C1005 JB 1A 104K-T	T	26.6/17.9
C2211	4030016930	S.CER C1005 JB 1A 104K-T	T	32.4/11.1
C2212	4030016930	S.CER C1005 JB 1A 104K-T	T	35.2/14.6
C2213	4030016930	S.CER C1005 JB 1A 104K-T	T	29.4/16.5
C2214	4030016930	S.CER C1005 JB 1A 104K-T	T	35.2/17.3
C2215	4030016930	S.CER C1005 JB 1A 104K-T	T	29.3/11.1
C2217	4030016930	S.CER C1005 JB 1A 104K-T	T	29.9/18.6
C2218	4030016930	S.CER C1005 JB 1A 104K-T	T	26.6/20.2
C2219	4030016930	S.CER C1005 JB 1A 104K-T	T	30.3/16.5
C2220	4030016930	S.CER C1005 JB 1A 104K-T	T	26.2/16.6
C2221	4030016930	S.CER C1005 JB 1A 104K-T	T	28.0/16.6
C2222	4030016930	S.CER C1005 JB 1A 104K-T	T	29.3/19.8
J651	6510024811	S.CON AXK6S60637YG	B	71.0/24.9
J701	6510022071	S.CON AXK6S30637YG	B	10.9/20.4
J1201	6510018891	S.CON 52559-1370(1390)	B	77.6/38.2
BT1301	3020000330	LIT ML-920S/DK		
EP2	6910012350	S.BEA MMZ1608Y 102BT	T	18.8/38.2
EP51	6910012350	S.BEA MMZ1608Y 102BT	B	18.2/29.8
EP201	6910014730	S.BEA MPZ2012S331A-T	T	13.4/40.6
EP301	6910012350	S.BEA MMZ1608Y 102BT	T	19.2/40.1
EP701	6910012350	S.BEA MMZ1608Y 102BT	B	5.6/15.4
EP2002	6910012350	S.BEA MMZ1608Y 102BT	B	38.2/27.7
EP2202	6910012350	S.BEA MMZ1608Y 102BT	T	19.2/22.0
EP2205	6910014730	S.BEA MPZ2012S331A-T	T	18.4/17.7
EP2217	6910015970	S.BEA MMZ1608B 301CT-AS	B	21.0/16.2

[CONNECT UNIT]

REF NO.	PARTS NO.	DESCRIPTION	M.	H/V LOCATION
J1	6510019971	S.CON 52808-1071	T	7.1/11.9
W1	8900016410	CAB OPC-1579A		

M.=Mounted side (T: Mounted on the Top side, B: Mounted on the Bottom side)
S.=Surface mount

[DDS UNIT]

REF NO.	PARTS NO.	DESCRIPTION	M.	H/V LOCATION
IC51	1190001811	S.IC AD9833BRMZ-REEL7 <FE>	T	38.7/3.5
IC52	1130012781	S.IC SN74AHC2G04HDC3	T	45.0/5.7
IC61	1130012610	S.IC SN74AHC1GU04DCKR	T	37.5/7.6
IC62	1130012850	S.IC SN74LVC3G34DCUR	T	51.4/24.7
IC251	1180002322	S.REG TK11218CMCL-GH	B	29.5/16.2
IC301	1190002101	S.IC AD9951YSVZ <FE>	T	37.5/28.2
IC401	1110004080	S.IC UPC2709T-E3	T	50.2/47.1
IC451	1110006430	S.IC UPC1678GV-E1-A	T	34.1/50.2
IC801	1110006430	S.IC UPC1678GV-E1-A	T	18.1/13.8
IC901	1130012720	S.IC CD74HC4094PWR	T	5.4/64.7
Q1	1530002381	S.TRA 2SC4215-Y(Te85LF)	T	20.5/3.2
Q101	1530002561	S.TRA 2SC4403-3-TL-E	T	26.6/6.4
Q151	1530003151	S.TRA 2SC4673D-TD-E	T	41.5/13.7
Q201	1530003432	S.TRA 2SC5226A-4-TL-E	T	43.5/19.5
Q211	1530003432	S.TRA 2SC5226A-4-TL-E	B	43.5/15.3
Q301	1590000680	S.TRA DTC114EUA T106	B	45.4/32.3
Q901	1590003930	S.TRA UMD22N TR	T	4.1/58.7
Q902	1590003930	S.TRA UMD22N TR	T	4.1/55.1
Q903	1590003930	S.TRA UMD22N TR	T	7.2/55.1
Q904	1590003930	S.TRA UMD22N TR	T	7.2/58.7
Q905	1590003930	S.TRA UMD22N TR	T	4.1/70.7
Q906	1590003930	S.TRA UMD22N TR	T	4.1/74.2
Q907	1590003930	S.TRA UMD22N TR	T	7.1/70.7
Q908	1590003930	S.TRA UMD22N TR	T	7.1/74.2
Q1101	1530002060	S.TRA 2SC4081 T106 R	T	40.9/53.9
Q1102	1540000451	S.TRA 2SD1623T-TD-E	T	45.5/54.3
D301	1750000620	S.DIO MA717WK(TX)	B	44.8/35.9
D341	1790001621	S.DIO 1SV308(TPL3F)	B	45.2/39.8
D451	1750000581	S.DIO 1SV307(TPH3F)	T	44.3/47.8
D452	1750000581	S.DIO 1SV307(TPH3F)	T	44.0/44.9
D453	1790001621	S.DIO 1SV308(TPL3F)	T	43.3/36.7
D454	1750000581	S.DIO 1SV307(TPH3F)	T	38.4/48.3
D456	1750000620	S.DIO MA717WK(TX)	B	35.2/42.9
D458	1750000581	S.DIO 1SV307(TPH3F)	T	33.8/45.6
D459	1750000581	S.DIO 1SV307(TPH3F)	T	31.4/38.9
D471	1750000620	S.DIO MA717WK(TX)	T	33.3/36.7
D501	1750000581	S.DIO 1SV307(TPH3F)	B	26.3/42.6
D502	1750000581	S.DIO 1SV307(TPH3F)	T	3.1/50.6
D551	1750000581	S.DIO 1SV307(TPH3F)	T	26.0/45.1
D552	1750000581	S.DIO 1SV307(TPH3F)	T	2.9/45.3
D601	1750000581	S.DIO 1SV307(TPH3F)	T	27.2/39.9
D602	1750000581	S.DIO 1SV307(TPH3F)	T	2.9/40.1
D651	1750000581	S.DIO 1SV307(TPH3F)	T	27.2/34.8
D652	1750000581	S.DIO 1SV307(TPH3F)	T	2.9/34.9
D701	1750000581	S.DIO 1SV307(TPH3F)	T	27.2/29.5
D702	1750000581	S.DIO 1SV307(TPH3F)	T	2.9/29.7
D751	1750000581	S.DIO 1SV307(TPH3F)	T	27.0/24.4
D752	1750000581	S.DIO 1SV307(TPH3F)	T	2.9/24.7
D801	1750000581	S.DIO 1SV307(TPH3F)	T	28.4/21.6
D802	1750000581	S.DIO 1SV307(TPH3F)	T	2.9/19.4
D1101	1750000301	S.DIO 1SS302(Te85RF)	T	40.9/57.7
D1102	1160000080	S.DIO DAP202K T146	B	28.0/63.1
FI101	2010002660	S.XTA DSF334SAF 124.032 MHz (FL-391)	T	29.4/10.7
FI201	2040001860	S.SAW NSVS776	T	34.5/16.6
X1	6050012800	S.XTA CR-788B VC-TCXO 24.8064 MHz	T	13.8/3.8
L1	6200002641	S.COI NLV25T-R15J	T	26.05/3.75
L51	6200005011	S.COI NLV25T-100J	B	35.6/4.2
L52	6200005011	S.COI NLV25T-100J	B	38.8/3.8
L53	6200003241	S.COI NLV32T-221J	B	43.5/8.7
L54	6200009351	S.COI ELJRE R22GFA	T	34.6/8.6
L101	6200003540	S.COI MLF1608D R22K-T	T	24.3/8.9
L105	6200012650	S.COI MLF1608A 1R5J-T	T	23.7/5.2
L151	6200004470	S.COI MLF1608D R12K-T	T	44.7/12.9
L153	6200004150	S.COI MLF1608D 47NM-T	T	46.9/15.7
L201	6200004150	S.COI MLF1608D 47NM-T	T	44.5/21.6
L202	6200005661	S.COI ELJRE 10NGFA	B	37.5/12.5
L204	6200003540	S.COI MLF1608D R22K-T	T	41.6/19.3
L205	6200005711	S.COI ELJRE 27NGFA	B	47.1/21.8
L206	6200005701	S.COI ELJRE 22NGFA	B	46.3/20.5
L210	6200005701	S.COI ELJRE 22NGFA	B	47.0/19.2
L212	6200002581	S.COI NLV25T-033J	B	41.9/12.8
L213	6200005681	S.COI ELJRE 15NGFA	B	40.1/17.9
L301	6140002810	S.COI LR-317	T	48.6/30.1
L302	6140002810	S.COI LR-317	T	48.8/38.9
L303	6200004150	S.COI MLF1608D 47NM-T	B	41.9/35.7
L304	6200003960	S.COI MLF1608A 1R0K-T	T	50.5/33.3
	6200003960	S.COI MLF1608A 1R0K-T	[EUR]	
	6200003960	S.COI MLF1608A 1R0K-T	[FRA]	
	6200003960	S.COI MLF1608A 1R0K-T	[ESP]	
	6200003960	S.COI MLF1608A 1R0K-T	[USA]	
	6200003960	S.COI MLF1608A 1R0K-T	[EXP]	
	6200003960	S.COI MLF1608A 1R0K-T	[ITR]	
	6200003960	S.COI MLF1608A 1R0K-T	[UK]	
	6200003960	S.COI MLF1608A 1R0K-T	[KOR]	
	6200003960	S.COI MLF1608A 1R0K-T	[CHN]	
L321	6200009560	S.COI MLG1608B R10J-T	T	50.5/34.7
L322	6200011770	S.COI LQW18ANR10G00D	T	47.9/34.7
L323	6200005671	S.COI ELJRE 12NGFA	T	53.6/30.1

[DDS UNIT]

REF NO.	PARTS NO.	DESCRIPTION	M.	H/V LOCATION
L331	6200009680	S.COI MLG1608B 47NJ-T	T	47.7/43.2
L332	6200009680	S.COI MLG1608B 47NJ-T	T	50.3/43.2
L341	6200004470	S.COI MLF1608D R12K-T	B	41.2/37.0
L401	6200001981	S.COI NLV25T-1R0J	T	50.3/50.0
L411	6200009610	S.COI MLG1608B 39NJ-T	T	47.3/48.4
L456	6140002810	S.COI LR-317	T	40.1/44.9
L458	6200009680	S.COI MLG1608B 47NJ-T	B	37.5/42.1
L461	6200009660	S.COI MLG1608B 10NJ-T	B	39.3/41.8
L464	6200002631	S.COI NLV25T-R10J	T	28.8/50.6
L465	6200004470	S.COI MLF1608D R12K-T	T	42.9/39.6
L466	6200011580	S.COI LQW18AN33NG00D	T	39.2/41.1
L467	6200009670	S.COI MLG1608B 12NJ-T	T	27.7/47.1
L468	6200009590	S.COI MLG1608B 18NJ-T	T	26.2/48.4
L469	6200009580	S.COI MLG1608B 15NJ-T	T	33.7/41.3
L471	6140002810	S.COI LR-317	T	38.7/37.3
L472	6200009680	S.COI MLG1608B 47NJ-T	T	33.4/39.4
L473	6200009540	S.COI MLG1608B 22NJ-T	T	35.5/40.5
L501	6200002611	S.COI NLV25T-R47J	B	21.8/43.7
L502	6200002631	S.COI NLV25T-R10J	B	18.2/46.8
L503	6200002431	S.COI NLV25T-082J	B	15.1/46.4
L504	6200002411	S.COI NLV25T-056J	T	14.4/49.1
L505	6200002421	S.COI NLV25T-068J	T	11.2/50.2
L506	6200002421	S.COI NLV25T-068J	T	8.3/49.7
L507	6200002611	S.COI NLV25T-R47J	T	3.9/48.2
L551	6200002611	S.COI NLV25T-R47J	T	24.9/42.6
L552	6200002421	S.COI NLV25T-068J	T	20.4/43.0
L553	6200002411	S.COI NLV25T-056J	T	17.6/42.9
L554	6200002601	S.COI NLV25T-047J	T	14.8/45.0
L555	6200002601	S.COI NLV25T-047J	T	12.0/44.3
L556	6200002581	S.COI NLV25T-033J	T	9.3/45.0
L557	6200002611	S.COI NLV25T-R47J	T	4.5/42.9
L601	6200002611	S.COI NLV25T-R47J	T	25.3/37.4
L602	6200002601	S.COI NLV25T-047J	T	22.6/39.6
L603	6200002591	S.COI NLV25T-039J	T	19.8/39.1
L604	6200003891	S.COI NLV25T-027J	T	16.9/39.9
L605	6200002601	S.COI NLV25T-047J	T	14.2/37.9
L606	6200002601	S.COI NLV25T-047J	T	11.4/37.7
L607	6200002421	S.COI NLV25T-068J	T	8.6/37.7
L608	6200002601	S.COI NLV25T-047J	T	5.1/37.7
L651	6200002611	S.COI NLV25T-R47J	T	26.0/32.2
L652	6200002591	S.COI NLV25T-039J	T	22.4/32.5
L653	6200002591	S.COI NLV25T-039J	T	19.6/32.8
L654	6200002591	S.COI NLV25T-039J	T	14.0/34.6
L655	6200002591	S.COI NLV25T-039J	T	11.2/33.9
L656	6200002601	S.COI NLV25T-047J	T	16.7/32.5
L657	6200002581	S.COI NLV25T-033J	T	7.9/34.6
L658	6200002611	S.COI NLV25T-R47J	T	5.2/32.6
L701	6200002611	S.COI NLV25T-R47J	T	26.0/26.9
L702	6200002581	S.COI NLV25T-033J	T	23.0/29.2
L703	6200002581	S.COI NLV25T-033J	T	20.2/28.8
L704	6200003891	S.COI NLV25T-027J	T	17.3/29.5
L705	6200002591	S.COI NLV25T-039J	T	14.6/27.3
L706	6200002581	S.COI NLV25T-033J	T	11.9/27.3
L707	6200002581	S.COI NLV25T-033J	T	9.1/27.3
L708	6200002611	S.COI NLV25T-R47J	T	4.6/27.3
L751	6200002611	S.COI NLV25T-R47J	T	26.0/22.0
L752	6200003881	S.COI NLV25T-022J	T	22.5/22.4
L753	6200003891	S.COI NLV25T-027J	T	19.7/22.4
L754	6200002581	S.COI NLV25T-033J	T	17.0/22.5
L755	6200003891	S.COI NLV25T-027J	T	14.2/24.2
L756	6200003891	S.COI NLV25T-027J	T	11.5/23.5
L757	6200003881	S.COI NLV25T-022J	T	8.7/24.2
L758	6200002611	S.COI NLV25T-R47J	T	4.0/22.3
L801	6200002181	S.COI NLV25T-R12J	T	28.4/17.6
L803	6200005711	S.COI ELJRE 27NGFA	T	26.3/17.6
L804	6200009070	S.COI LQW18AN18NG00D (LQW1608A18NG00)	T	25.1/15.6
L805	6200009220	S.COI LQW18AN15NG00D (LQW1608A15NG00)	T	23.2/15.0
L806	6200005641	S.COI ELJRE 6N8ZFA	T	21.6/19.0
L807	6200009670	S.COI MLG1608B 12NJ-T	T	18.7/18.3
L808	6200004720	S.COI MLF1608D R10K-T	T	18.0/10.1
L812	6200005711	S.COI ELJRE 27NGFA	T	14.9/14.5
L813	6200009070	S.COI LQW18AN18NG00D (LQW1608A18NG00)	T	15.8/17.3
L814	6200009220	S.COI LQW18AN15NG00D (LQW1608A15NG00)	T	13.9/18.3
L815	6200005641	S.COI ELJRE 6N8ZFA	T	10.1/18.1
L816	6200010700	S.COI LQW18AN12NG00D	T	6.6/17.9
L818	6200002181	S.COI NLV25T-R12J	T	4.6/17.0
L851	6200002181	S.COI NLV25T-R12J	B	26.8/30.6
L852	6200002611	S.COI NLV25T-R47J	B	26.4/34.1
L853	6200002181	S.COI NLV25T-R12J	B	3.4/22.8
L854	6200002611	S.COI NLV25T-R47J	B	5.4/26.0
L901	6200007420	S.COI ELJFC 101K-F	B	3.8/66.0
L953	6200002041	S.COI NLV25T-101J	B	56.5/44.6
L954	6200002041	S.COI NLV25T-101J	B	55.8/42.1
L955	6200002041	S.COI NLV25T-101J	B	55.9/39.6
L956	6200002041	S.COI NLV25T-101J	B	56.1/37.1
L957	6200002041	S.COI NLV25T-101J	B	56.0/34.6
L959	6200011300	S.COI EXCML16A270U	T	54.9/34.3
L960	6200002041	S.COI NLV25T-101J	B	56.7/30.3
L962	6200011300	S.COI EXCML16A270U	B	59.2/32.2
L963	6200011300	S.COI EXCML16A270U	B	60.4/32.2
L1001	6200003241	S.COI NLV32T-221J	B	53.7/50.9
L1002	6200003241	S.COI NLV32T-221J	B	47.9/55.0
L1103	6200002041	S.COI NLV25T-101J	B	42.2/61.2
L1105	6200002041	S.COI NLV25T-101J	B	40.8/71.8

M.=Mounted side (T: Mounted on the Top side, B: Mounted on the Bottom side)
S.=Surface mount

[DDS UNIT]

REF NO.	PARTS NO.	DESCRIPTION	M.	H/V LOCATION
L1106	6200002041	S.COI NLV25T-101J	T	36.4/62.3
L1107	6200002041	S.COI NLV25T-101J	B	34.9/74.7
L1110	6200002041	S.COI NLV25T-101J	T	32.4/62.3
L1111	6200002041	S.COI NLV25T-101J	B	26.1/69.8
L1112	6200002041	S.COI NLV25T-101J	T	29.9/62.3
L1152	6200003590	S.COI EXCCL3225U1	T	48.3/69.2
L1153	6200002041	S.COI NLV25T-101J	T	45.5/69.3
L1154	6200002041	S.COI NLV25T-101J	T	53.6/69.2
R2	7030007290	S.RES ERJ2GEJ 222 X (2.2K)	T	19.1/4.6
R3	7030005040	S.RES ERJ2GEJ 472 X (4.7K)	T	18.7/1.8
R4	7030004990	S.RES ERJ2GEJ 221 X (220)	T	22.2/2.60
R5	7030004980	S.RES ERJ2GEJ 101 X (100)	T	20.9/6.9
R8	7030003630	S.RES ERJ3GEYJ 393 V (39K)	B	13.7/7.2
R9	7030003610	S.RES ERJ3GEYJ 273 V (27K)	B	13.7/9.8
R10	7030005060	S.RES ERJ2GEJ 333 X (33K)	T	8.1/3.3
R11	7030010040	S.RES ERJ2GEJ-JPW	T	9.3/3.7
R51	7030005120	S.RES ERJ2GEJ 102 X (1K)	T	35.8/9.5
R52	7030005120	S.RES ERJ2GEJ 102 X (1K)	T	46.2/2.3
R53	7030005120	S.RES ERJ2GEJ 102 X (1K)	T	42.8/3.6
R54	7030005120	S.RES ERJ2GEJ 102 X (1K)	T	42.8/2.7
R61	7030005050	S.RES ERJ2GEJ 103 X (10K)	T	39.3/8.1
R62	7030005530	S.RES ERJ2GEJ 100 X (10)	T	49.3/23.2
R101	7030005000	S.RES ERJ2GEJ 471 X (470)	T	25.2/7.8
R102	7030004980	S.RES ERJ2GEJ 101 X (100)	T	22.1/7.4
R103	7030005570	S.RES ERJ2GEJ 820 X (82)	T	31.9/11.1
R104	7030004980	S.RES ERJ2GEJ 101 X (100)	T	33.1/11.6
R105	7030005570	S.RES ERJ2GEJ 820 X (82)	T	34.3/11.2
R106	7030005100	S.RES ERJ2GEJ 154 X (150K)	T	23.9/7.4
R121	7030005040	S.RES ERJ2GEJ 472 X (4.7K)	T	38.5/11.1
R150	7030005570	S.RES ERJ2GEJ 820 X (82)	T	45.9/10.7
R151	7030004980	S.RES ERJ2GEJ 101 X (100)	T	45.0/10.7
R154	7030005050	S.RES ERJ2GEJ 103 X (10K)	T	41.5/10.7
R155	7030005530	S.RES ERJ2GEJ 100 X (10)	T	46.3/12.6
R157	7030007270	S.RES ERJ2GEJ 151 X (150)	T	48.9/18.2
R158	7030009200	S.RES ERJ2GEJ 390 X (39)	T	48.0/16.8
R159	7030007270	S.RES ERJ2GEJ 151 X (150)	T	48.0/18.2
R160	7030005300	S.RES ERJ2GEJ 150 X (15)	T	44.2/16.0
R161	7030004980	S.RES ERJ2GEJ 101 X (100)	T	45.1/16.0
R162	7030005300	S.RES ERJ2GEJ 150 X (15)	T	45.0/14.7
R201	7030005530	S.RES ERJ2GEJ 100 X (10)	T	45.9/22.1
R202	7030000700	S.RES MCR10EZHJ 470 K (474)	T	45.7/18.8
R211	7030003400	S.RES ERJ3GEYJ 471 V (470)	B	37.3/17.9
R212	7030003440	S.RES ERJ3GEYJ 102 V (1K)	B	40.8/16.3
R213	7030003200	S.RES ERJ3GEYJ 100 V (10)	B	44.6/11.4
R214	7030003280	S.RES ERJ3GEYJ 470 V (47)	B	46.8/16.4
R301	7030005120	S.RES ERJ2GEJ 102 X (1K)	T	34.2/22.2
R303	7030010040	S.RES ERJ2GEJ-JPW	T	40.0/22.2
R304	7030005120	S.RES ERJ2GEJ 102 X (1K)	T	42.0/24.6
R305	7030005710	S.RES ERJ2GEJ 121 X (120)	T	44.2/29.0
R306	7030005120	S.RES ERJ2GEJ 102 X (1K)	T	31.6/25.7
R309	7030005120	S.RES ERJ2GEJ 102 X (1K)	T	31.2/29.5
R310	7030005120	S.RES ERJ2GEJ 102 X (1K)	T	31.3/30.5
R311	7030005120	S.RES ERJ2GEJ 102 X (1K)	T	31.3/31.5
R312	7030010040	S.RES ERJ2GEJ-JPW	T	32.9/31.7
R313	7030005710	S.RES ERJ2GEJ 121 X (120)	T	43.3/28.5
R314	7030009140	S.RES ERJ2GEJ 272 X (2.7K)	T	43.0/31.8
R315	7030005120	S.RES ERJ2GEJ 102 X (1K)	T	33.5/32.6
R316	7030005050	S.RES ERJ2GEJ 103 X (10K)	T	34.6/33.8
R317	7030004990	S.RES ERJ2GEJ 221 X (220)	T	43.9/31.8
R318	7030003860	S.RES ERJ3GE JPW V	B	35.8/28.4
R341	7030003440	S.RES ERJ3GEYJ 102 V (1K)	B	44.4/38.3
R342	7030003440	S.RES ERJ3GEYJ 102 V (1K)	B	46.0/41.2
R451	7030005120	S.RES ERJ2GEJ 102 X (1K)	T	44.6/46.3
R452	7030003860	S.RES ERJ3GE JPW V	B	48.6/44.6
R453	7030010090	S.RES ERJ2GEJ 180 X (18)	T	34.1/47.5
R454	7030008280	S.RES ERJ2GEJ 271 X (270)	T	32.9/47.1
R455	7030008280	S.RES ERJ2GEJ 271 X (270)	T	32.9/48.0
R456	7030010040	S.RES ERJ2GEJ-JPW	T	34.9/52.5
R457	7030005120	S.RES ERJ2GEJ 102 X (1K)	T	38.2/49.7
R458	7030004990	S.RES ERJ2GEJ 221 X (220)	T	31.6/43.6
R459	7030005090	S.RES ERJ2GEJ 104 X (100K)	T	42.1/50.0
R460	7030003680	S.RES ERJ3GEYJ 104 V (100K)	T	30.8/41.1
R461	7030005090	S.RES ERJ2GEJ 104 X (100K)	T	29.7/39.1
R462	7030003860	S.RES ERJ3GE JPW V	T	45.1/43.3
R463	7030003400	S.RES ERJ3GEYJ 471 V (470)	T	33.3/44.1
R464	7030004980	S.RES ERJ2GEJ 101 X (100)	T	40.8/47.9
R465	7030005570	S.RES ERJ2GEJ 820 X (82)	T	40.3/50.0
R467	7030005570	S.RES ERJ2GEJ 820 X (82)	T	40.8/48.8
R468	7030005570	S.RES ERJ2GEJ 820 X (82)	T	41.2/50.0
R469	7030003320	S.RES ERJ3GEYJ 101 V (100)	B	37.8/40.0
R471	7030005000	S.RES ERJ2GEJ 471 X (470)	T	41.7/37.7
R472	7030004990	S.RES ERJ2GEJ 221 X (220)	T	30.4/43.3
R473	7030007270	S.RES ERJ2GEJ 151 X (150)	T	31.8/34.5
R474	7030009200	S.RES ERJ2GEJ 390 X (39)	T	31.3/35.7
R475	7030007270	S.RES ERJ2GEJ 151 X (150)	T	30.1/35.4
R476	7030005000	S.RES ERJ2GEJ 471 X (470)	T	30.0/37.9
R477	7030003320	S.RES ERJ3GEYJ 101 V (100)	B	35.8/38.7
R501	7030003390	S.RES ERJ3GEYJ 391 V (390)	B	21.0/46.1
R502	7030009280	S.RES ERJ2GEJ 391 X	T	5.9/46.9
R503	7030005090	S.RES ERJ2GEJ 104 X (100K)	T	14.3/46.8
R505	7030005570	S.RES ERJ2GEJ 820 X (82)	T	6.5/48.6
R506	7030005570	S.RES ERJ2GEJ 820 X (82)	T	6.1/49.8
R507	7030005570	S.RES ERJ2GEJ 820 X (82)	T	5.6/48.6
R551	7030009280	S.RES ERJ2GEJ 391 X	T	23.1/42.0
R552	7030009280	S.RES ERJ2GEJ 391 X	T	6.3/42.0
R553	7030005090	S.RES ERJ2GEJ 104 X (100K)	T	10.1/41.6

[DDS UNIT]

REF NO.	PARTS NO.	DESCRIPTION	M.	H/V LOCATION
R554	7030009200	S.RES ERJ2GEJ 390 X (39)	T	6.4/45.7
R555	7030007270	S.RES ERJ2GEJ 151 X (150)	T	7.2/44.5
R556	7030007270	S.RES ERJ2GEJ 151 X (150)	T	6.3/44.4
R601	7030008280	S.RES ERJ2GEJ 271 X (270)	T	23.2/36.1
R602	7030009280	S.RES ERJ2GEJ 391 X	T	6.9/36.6
R603	7030005090	S.RES ERJ2GEJ 104 X (100K)	T	19.6/36.4
R604	7030004980	S.RES ERJ2GEJ 101 X (100)	T	20.8/36.1
R651	7030009280	S.RES ERJ2GEJ 391 X	T	24.2/31.2
R652	7030009280	S.RES ERJ2GEJ 391 X	T	6.4/30.5
R653	7030005090	S.RES ERJ2GEJ 104 X (100K)	T	9.9/31.2
R701	7030009280	S.RES ERJ2GEJ 391 X	T	23.8/25.8
R702	7030009280	S.RES ERJ2GEJ 391 X	T	6.6/26.0
R703	7030005090	S.RES ERJ2GEJ 104 X (100K)	T	19.9/26.0
R704	7030004980	S.RES ERJ2GEJ 101 X (100)	T	7.2/27.3
R705	7030005710	S.RES ERJ2GEJ 121 X (120)	T	6.8/28.5
R706	7030004980	S.RES ERJ2GEJ 101 X (100)	T	6.3/27.3
R751	7030009280	S.RES ERJ2GEJ 391 X	T	24.2/21.0
R752	7030009280	S.RES ERJ2GEJ 391 X	T	6.0/20.8
R753	7030005090	S.RES ERJ2GEJ 104 X (100K)	T	10.3/20.8
R755	7030004980	S.RES ERJ2GEJ 101 X (100)	T	6.6/22.6
R756	7030005580	S.RES ERJ2GEJ 560 X (56)	T	6.6/24.2
R757	7030004980	S.RES ERJ2GEJ 101 X (100)	T	5.7/23.3
R801	7030008280	S.RES ERJ2GEJ 271 X (270)	T	27.3/14.6
R805	7030005570	S.RES ERJ2GEJ 820 X (82)	T	14.0/10.4
R806	7030005570	S.RES ERJ2GEJ 820 X (82)	T	14.3/11.7
R807	7030005570	S.RES ERJ2GEJ 820 X (82)	T	13.1/11.3
R808	7030003390	S.RES ERJ3GEYJ 391 V (390)	B	3.6/17.9
R810	7030005090	S.RES ERJ2GEJ 104 X (100K)	T	27.3/15.6
R841	7030005710	S.RES ERJ2GEJ 121 X (120)	T	21.2/12.5
R851	7030009280	S.RES ERJ2GEJ 391 X	T	27.1/37.3
R852	7030008280	S.RES ERJ2GEJ 271 X (270)	T	5.7/13.8
R853	7030010090	S.RES ERJ2GEJ 180 X (18)	T	6.9/14.0
R854	7030008280	S.RES ERJ2GEJ 271 X (270)	T	6.9/13.0
R855	7030003390	S.RES ERJ3GEYJ 391 V (390)	B	5.5/29.5
R901	7030005120	S.RES ERJ2GEJ 102 X (1K)	T	2.1/62.6
R902	7030005120	S.RES ERJ2GEJ 102 X (1K)	T	2.2/60.9
R903	7030005120	S.RES ERJ2GEJ 102 X (1K)	T	2.3/58.7
R951	7030003360	S.RES ERJ3GEYJ 221 V (220)	B	59.2/6.9
R952	7030004990	S.RES ERJ2GEJ 221 X (220)	T	54.1/9.3
R953	7030003360	S.RES ERJ3GEYJ 221 V (220)	B	59.5/3.3
R954	7030004990	S.RES ERJ2GEJ 221 X (220)	T	53.2/8.9
R955	7030004990	S.RES ERJ2GEJ 221 X (220)	T	55.3/7.8
R956	7030003360	S.RES ERJ3GEYJ 221 V (220)	B	59.2/4.9
R957	7030003360	S.RES ERJ3GEYJ 221 V (220)	B	56.6/5.0
R958	7030004990	S.RES ERJ2GEJ 221 X (220)	T	47.3/6.2
R959	7030003360	S.RES ERJ3GEYJ 221 V (220)	B	57.9/51.0
R960	7030003280	S.RES ERJ3GEYJ 470 V (47)	B	57.6/49.0
R961	7030004990	S.RES ERJ2GEJ 221 X (220)	T	54.6/11.7
R962	7030003860	S.RES ERJ3GE JPW V	T	51.4/21.0
R1051	7030003860	S.RES ERJ3GE JPW V	B	10.8/73.0
R1101	7030005120	S.RES ERJ2GEJ 102 X (1K)	T	40.6/52.2
R1102	7030005050	S.RES ERJ2GEJ 103 X (10K)	T	42.2/52.2
R1103	7030004980	S.RES ERJ2GEJ 101 X (100)	T	39.3/63.4
R1104	7030005050	S.RES ERJ2GEJ 103 X (10K)	T	44.2/51.3
R1105	7030004980	S.RES ERJ2GEJ 101 X (100)	T	38.7/60.9
R1106	7030007290	S.RES ERJ2GEJ 222 X (2.2K)	T	31.8/59.6
R1107	7030007290	S.RES ERJ2GEJ 222 X (2.2K)	T	28.1/59.6
R1108	7030005240	S.RES ERJ2GEJ 473 X (47K)	T	46.9/8.5
R1109	7030005240	S.RES ERJ2GEJ 473 X (47K)	T	47.9/8.5
C1	4030016950	S.CER C1005 JB 1A 473K-T	T	17.5/4.6
C2	4030017780	S.CER C1005 JB 1H 472K-T	T	20.9/5.0
C3	4030017510	S.CER C1005 CH 1H 680J-T	T	24.9/1.7
C4	4030017780	S.CER C1005 JB 1H 472K-T	T	22.4/4.0
C5	4030017680	S.CER C1005 CH 1H 820J-T	T	26.1/2.6
C6	4030017510	S.CER C1005 CH 1H 680J-T	T	27.3/1.7
C7	4030016930	S.CER C1005 JB 1A 104K-T	T	8.1/4.2
C8	4030016790	S.CER C1005 JB 1E 103K-T	T	10.1/5.7
C51	4030017780	S.CER C1005 JB 1H 472K-T	T	33.8/6.5
C52	4030017780	S.CER C1005 JB 1H 472K-T	T	36.1/5.3
C53	4030017780	S.CER C1005 JB 1H 472K-T	T	37.0/9.4
C54	4030016930	S.CER C1005 JB 1A 104K-T	T	34.9/4.5
C55	4510008580	S.LEE EEE0JA470SR	T	30.7/4.0
C56	4030016930	S.CER C1005 JB 1A 104K-T	T	34.9/2.9
C57	4030016930	S.CER C1005 JB 1A 104K-T	T	42.8/5.0
C58	4030016930	S.CER C1005 JB 1A 104K-T	T	41.0/5.9
C59	4030017720	S.CER C1005 JB 1H 331K-T	T	41.9/6.6
C60	4030017690	S.CER C1005 CH 1H 121J-T	T	42.2/7.8
C61	4030017720	S.CER C1005 JB 1H 331K-T	T	42.8/6.6
C62	4030016930	S.CER C1005 JB 1A 104K-T	T	35.7/6.5
C63	4030016930	S.CER C1005 JB 1H 472K-T	T	49.3/22.3
C64	4030017710	S.CER C1005 CH 1H 181J-T	T	34.7/6.5
C65	4030017710	S.CER C1005 CH 1H 181J-T	T	33.5/8.9
C101	4030017580	S.CER C1005 CH 1H 060C-T	T	26.5/8.7
C102	4030017660	S.CER C1005 CH 1H 330J-T	T	23.1/2.6
C104	4030017780	S.CER C1005 JB 1H 472K-T	T	20.9/7.8
C105	4030017460	S.CER C1005 JB 1H 102K-T	T	24.8/6.5
C120	4030017780	S.CER C1005 JB 1H 472K-T	T	37.3/11.6
C126	40300			

[DDS UNIT]

REF NO.	PARTS NO.	DESCRIPTION	M.	H/V LOCATION
C203	4030007060	S.CER C1608 CH 1H 270J-T	B	37.8/16.0
C204	4030016930	S.CER C1005 JB 1A 104K-T	T	35.2/20.2
C206	4030017560	S.CER C1005 CH 1H 2R5B-T	T	43.4/21.7
C207	4030007110	S.CER C1608 CH 1H 680J-T	B	44.0/21.8
C208	4030009910	S.CER C1608 CH 1H 040B-T	B	40.9/21.8
C209	4030007060	S.CER C1608 CH 1H 270J-T	B	43.2/20.5
C210	4030009910	S.CER C1608 CH 1H 040B-T	B	40.8/19.8
C211	4030017460	S.CER C1005 JB 1H 102K-T	T	42.2/17.6
C216	4030017780	S.CER C1005 JB 1H 472K-T	T	46.3/20.9
C217	4030007120	S.CER C1608 CH 1H 820J-T	B	43.9/19.2
C218	4030011770	S.CER C1608 CH 1H 060B-T	B	43.2/17.9
C219	4030007010	S.CER C1608 CH 1H 100D-T	B	46.3/17.8
C221	4030006880	S.CER C1608 JB 1H 472K-T	B	46.1/15.1
C222	4030009910	S.CER C1608 CH 1H 040B-T	B	40.8/14.7
C223	4030006880	S.CER C1608 JB 1H 472K-T	B	46.0/13.5
C224	4030018630	S.CER C2012 CH 1H 472J-T	B	39.3/11.5
C225	4030006860	S.CER C1608 JB 1H 102K-T	B	38.5/19.4
C251	4030011600	S.CER C1608 JB 1E 104K-T	B	27.6/12.2
C252	4030011600	S.CER C1608 JB 1E 104K-T	B	28.7/23.5
C253	4550007090	S.TAN TEESVA 1A 226M8R	B	29.6/21.7
C254	4030011600	S.CER C1608 JB 1E 104K-T	B	29.2/12.2
C255	4550007090	S.TAN TEESVA 1A 226M8R	B	29.5/19.3
C302	4030016930	S.CER C1005 JB 1A 104K-T	T	36.2/22.2
C303	4030016930	S.CER C1005 JB 1A 104K-T	T	37.3/22.3
C304	4030016930	S.CER C1005 JB 1A 104K-T	T	38.2/22.2
C305	4030016930	S.CER C1005 JB 1A 104K-T	T	39.1/22.2
C306	4030016930	S.CER C1005 JB 1A 104K-T	T	43.6/24.6
C307	4030016930	S.CER C1005 JB 1A 104K-T	T	31.2/28.4
C308	4030016930	S.CER C1005 JB 1A 104K-T	T	43.6/25.5
C309	4030016930	S.CER C1005 JB 1A 104K-T	T	43.1/26.7
C310	4030016930	S.CER C1005 JB 1A 104K-T	T	44.0/26.7
C312	4030016930	S.CER C1005 JB 1A 104K-T	T	43.5/30.6
C317	4030011600	S.CER C1608 JB 1E 104K-T	B	44.0/26.1
C318	4030006880	S.CER C1608 JB 1H 472K-T	B	39.3/25.5
C321	4030017500	S.CER C1005 CH 1H 560J-T	T	51.3/30.2
C323	4030017510	S.CER C1005 CH 1H 680J-T	T	48.6/33.4
C325	4030017660	S.CER C1005 CH 1H 330J-T	T	48.8/35.8
C326	4030017640	S.CER C1005 CH 1H 150J-T	T	53.1/32.1
C328	4030006880	S.CER C1608 JB 1H 472K-T	B	39.7/29.7
C331	4030017390	S.CER C1005 CH 1H 180J-T	T	46.6/44.6
C333	4030017670	S.CER C1005 CH 1H 390J-T	T	48.4/44.5
C335	4030017390	S.CER C1005 CH 1H 180J-T	T	50.2/44.5
C341	4030007130	S.CER C1608 CH 1H 101J-T	B	42.5/39.8
C342	4030007090	S.CER C1608 CH 1H 470J-T	B	43.8/42.1
C343	4030007140	S.CER C1608 CH 1H 121J-T	B	41.3/39.0
C344	4030007100	S.CER C1608 CH 1H 560J-T	B	42.8/34.3
C345	4030017660	S.CER C1005 CH 1H 330J-T	T	45.5/37.9
C346	4030017660	S.CER C1005 CH 1H 330J-T	T	45.8/39.7
C347	4030006860	S.CER C1608 JB 1H 102K-T	B	48.5/31.7
C401	4030017460	S.CER C1005 JB 1H 102K-T	T	51.1/44.5
C402	4030017460	S.CER C1005 JB 1H 102K-T	T	52.4/49.0
C403	4030017430	S.CER C1005 CH 1H 101J-T	T	48.0/46.1
C411	4030017400	S.CER C1005 CH 1H 220J-T	T	48.2/49.8
C412	4030017630	S.CER C1005 CH 1H 120J-T	T	47.7/47.3
C413	4030017400	S.CER C1005 CH 1H 220J-T	T	46.7/49.4
C451	4030017420	S.CER C1005 CH 1H 470J-T	T	40.2/40.6
C453	4030017460	S.CER C1005 JB 1H 102K-T	T	46.1/46.8
C454	4030017460	S.CER C1005 JB 1H 102K-T	T	35.3/48.0
C456	4030016930	S.CER C1005 JB 1A 104K-T	T	31.3/48.0
C457	4030017460	S.CER C1005 JB 1H 102K-T	T	35.3/47.1
C458	4030017460	S.CER C1005 JB 1H 102K-T	T	30.6/49.8
C459	4030017460	S.CER C1005 JB 1H 102K-T	T	27.1/50.6
C460	4030017780	S.CER C1005 JB 1H 472K-T	T	39.4/50.1
C461	4030006880	S.CER C1608 JB 1H 472K-T	T	30.8/42.3
C463	4030017420	S.CER C1005 CH 1H 470J-T	T	40.7/41.9
C464	4030017690	S.CER C1005 CH 1H 121J-T	T	41.5/40.3
C465	4030017400	S.CER C1005 CH 1H 220J-T	T	37.8/41.8
C466	4030017570	S.CER C1005 CH 1H 040B-T	T	38.1/40.6
C467	4030017400	S.CER C1005 CH 1H 220J-T	T	37.2/40.6
C468	4030017360	S.CER C1005 CH 1H 030B-T	T	29.1/48.0
C469	4030017370	S.CER C1005 CH 1H 3R5B-T	T	29.1/47.1
C470	4030017380	S.CER C1005 CH 1H 050B-T	T	29.1/46.2
C471	4030017380	S.CER C1005 CH 1H 050B-T	T	35.7/43.9
C472	4030017660	S.CER C1005 CH 1H 330J-T	T	34.8/41.8
C473	4030017570	S.CER C1005 CH 1H 040B-T	T	34.1/43.0
C474	4030017460	S.CER C1005 JB 1H 102K-T	T	41.7/36.8
C475	4030017460	S.CER C1005 JB 1H 102K-T	T	30.6/36.7
C476	4030017780	S.CER C1005 JB 1H 472K-T	T	29.7/40.0
C477	4030017780	S.CER C1005 JB 1H 472K-T	T	42.4/48.8
C478	4030006880	S.CER C1608 JB 1H 472K-T	B	39.8/39.2
C479	4030006880	S.CER C1608 JB 1H 472K-T	B	38.1/37.9
C480	4030017630	S.CER C1005 CH 1H 120J-T	T	35.7/41.8
C481	4030017360	S.CER C1005 CH 1H 030B-T	T	35.7/43.0
C501	4030007080	S.CER C1608 CH 1H 390J-T	B	19.1/42.6
C502	4030007120	S.CER C1608 CH 1H 820J-T	B	18.3/44.1
C503	4030007060	S.CER C1608 CH 1H 270J-T	B	16.1/43.8
C504	4030017780	S.CER C1005 JB 1H 472K-T	T	16.2/49.3
C505	4030017660	S.CER C1005 CH 1H 330J-T	T	12.6/47.2
C506	4030017620	S.CER C1005 CH 1H 100C-T	T	12.1/48.4
C507	4030017500	S.CER C1005 CH 1H 560J-T	T	11.4/47.2
C508	4030017580	S.CER C1005 CH 1H 060C-T	T	10.5/48.4
C509	4030017420	S.CER C1005 CH 1H 470J-T	T	10.2/47.2
C510	4030017350	S.CER C1005 CH 1H 020B-T	T	8.9/47.5
C511	4030017670	S.CER C1005 CH 1H 390J-T	T	7.7/47.2
C512	4030017780	S.CER C1005 JB 1H 472K-T	T	5.6/50.7
C513	4030017780	S.CER C1005 JB 1H 472K-T	T	15.9/46.8
C551	4030017650	S.CER C1005 CH 1H 270J-T	T	22.5/45.4
C552	4030017500	S.CER C1005 CH 1H 560J-T	T	21.1/45.0

[DDS UNIT]

REF NO.	PARTS NO.	DESCRIPTION	M.	H/V LOCATION
C553	4030017650	S.CER C1005 CH 1H 270J-T	T	19.2/45.4
C554	4030017780	S.CER C1005 JB 1H 472K-T	T	15.6/43.2
C555	4030017670	S.CER C1005 CH 1H 390J-T	T	14.5/42.0
C556	4030017350	S.CER C1005 CH 1H 020B-T	T	14.0/43.2
C557	4030017420	S.CER C1005 CH 1H 470J-T	T	13.2/42.0
C558	4030017590	S.CER C1005 CH 1H 070C-T	T	10.0/43.2
C559	4030017420	S.CER C1005 CH 1H 470J-T	T	8.9/42.0
C560	4030017630	S.CER C1005 CH 1H 120J-T	T	8.4/43.2
C561	4030017660	S.CER C1005 CH 1H 330J-T	T	7.9/42.0
C562	4030017780	S.CER C1005 JB 1H 472K-T	T	5.0/45.4
C563	4030017780	S.CER C1005 JB 1H 472K-T	T	11.7/41.6
C601	4030017780	S.CER C1005 JB 1H 472K-T	T	24.7/39.9
C602	4030017400	S.CER C1005 CH 1H 220J-T	T	23.3/37.6
C603	4030017360	S.CER C1005 CH 1H 030B-T	T	21.9/37.8
C604	4030017630	S.CER C1005 CH 1H 120J-T	T	13.3/40.4
C605	4030017620	S.CER C1005 CH 1H 100C-T	T	11.7/40.4
C606	4030017660	S.CER C1005 CH 1H 330J-T	T	18.4/36.9
C607	4030017600	S.CER C1005 CH 1H 080C-T	T	17.8/38.1
C608	4030017650	S.CER C1005 CH 1H 270J-T	T	17.2/36.9
C609	4030017640	S.CER C1005 CH 1H 150J-T	T	16.2/38.1
C610	4030017640	S.CER C1005 CH 1H 150J-T	T	15.9/36.9
C611	4030017440	S.CER C1005 CH 1H 221J-T	T	12.2/39.5
C612	4030017510	S.CER C1005 CH 1H 680J-T	T	10.3/40.0
C613	4030017620	S.CER C1005 CH 1H 100C-T	T	8.2/40.1
C614	4030017640	S.CER C1005 CH 1H 150J-T	T	5.4/40.4
C615	4030017670	S.CER C1005 CH 1H 390J-T	T	6.9/40.0
C616	4030017780	S.CER C1005 JB 1H 472K-T	T	6.9/38.2
C617	4030017780	S.CER C1005 JB 1H 472K-T	T	22.0/36.4
C618	4030017650	S.CER C1005 CH 1H 270J-T	T	3.4/37.2
C651	4030017620	S.CER C1005 CH 1H 100C-T	T	24.6/34.8
C652	4030017450	S.CER C1005 JB 1H 271K-T	T	23.7/34.8
C653	4030017590	S.CER C1005 CH 1H 070C-T	T	21.7/35.2
C654	4030017680	S.CER C1005 CH 1H 820J-T	T	20.4/34.8
C655	4030017600	S.CER C1005 CH 1H 080C-T	T	19.2/35.2
C656	4030017420	S.CER C1005 CH 1H 470J-T	T	17.9/34.8
C657	4030017630	S.CER C1005 CH 1H 120J-T	T	16.5/35.2
C658	4030017340	S.CER C1005 CH 1H 010B-T	T	13.3/32.8
C659	4030017360	S.CER C1005 CH 1H 030B-T	T	9.4/32.6
C660	4030017640	S.CER C1005 CH 1H 150J-T	T	14.6/32.3
C661	4030017650	S.CER C1005 CH 1H 270J-T	T	12.8/31.6
C662	4030017400	S.CER C1005 CH 1H 220J-T	T	8.5/31.6
C663	4030017380	S.CER C1005 CH 1H 050B-T	T	8.0/32.8
C664	4030017460	S.CER C1005 JB 1H 102K-T	T	5.4/34.9
C665	4030017390	S.CER C1005 CH 1H 180J-T	T	7.6/31.6
C666	4030017780	S.CER C1005 JB 1H 472K-T	T	11.5/31.2
C701	4030017460	S.CER C1005 JB 1H 102K-T	T	25.1/29.4
C702	4030017640	S.CER C1005 CH 1H 150J-T	T	23.7/27.2
C703	4030017540	S.CER C1005 CH 1H R75B-T	T	22.3/27.5
C704	4030017650	S.CER C1005 CH 1H 270J-T	T	18.7/26.4
C705	4030017350	S.CER C1005 CH 1H 020B-T	T	18.2/27.7
C706	4030017400	S.CER C1005 CH 1H 220J-T	T	17.5/26.4
C707	4030017570	S.CER C1005 CH 1H 040B-T	T	16.6/27.7
C708	4030017390	S.CER C1005 CH 1H 180J-T	T	16.4/26.4
C709	4030017590	S.CER C1005 CH 1H 070C-T	T	14.0/30.0
C710	4030017500	S.CER C1005 CH 1H 560J-T	T	12.6/29.1
C711	4030017380	S.CER C1005 CH 1H 050B-T	T	12.0/30.0
C712	4030017500	S.CER C1005 CH 1H 560J-T	T	10.7/29.3
C713	4030017380	S.CER C1005 CH 1H 050B-T	T	9.5/29.6
C714	4030017710	S.CER C1005 CH 1H 181J-T	T	8.2/29.7
C715	4030017630	S.CER C1005 CH 1H 120J-T	T	7.0/29.4
C716	4030017780	S.CER C1005 JB 1H 472K-T	T	21.5/26.0
C717	4030017460	S.CER C1005 JB 1H 102K-T	T	5.4/29.4
C751	4030017590	S.CER C1005 CH 1H 070C-T	T	24.9/24.5
C752	4030017710	S.CER C1005 CH 1H 181J-T	T	24.0/24.5
C753	4030017380	S.CER C1005 CH 1H 050B-T	T	21.5/24.9
C754	4030017500	S.CER C1005 CH 1H 560J-T	T	20.5/24.0
C755	4030017380	S.CER C1005 CH 1H 050B-T	T	19.9/24.9
C756	4030017650	S.CER C1005 CH 1H 270J-T	T	18.7/24.4
C757	4030017600	S.CER C1005 CH 1H 080C-T	T	16.7/24.8
C758	4030017610	S.CER C1005 CH 1H 090C-T	T	15.0/21.9
C759	4030017530	S.CER C1005 CH 1H 0R5B-T	T	14.1/22.2
C760	4030017640	S.CER C1005 CH 1H 150J-T	T	13.2/21.9
C761	4030017350	S.CER C1005 CH 1H 020B-T	T	9.7/22.2
C762	4030017630	S.CER C1005 CH 1H 120J-T	T	8.6/21.2
C763	4030017360	S.CER C1005 CH 1H 030B-T	T	8.2/22.4
C764	4030017620	S.CER C1005 CH 1H 100C-T	T	7.7/21.2
C765	4030017460	S.CER C1005 JB 1H 102K-T	T	5.4/24.7
C766	4030017780	S.CER C1		

[DDS UNIT]

REF NO.	PARTS NO.	DESCRIPTION	M.	H/V LOCATION
C829	4030017660	S.CER C1005 CH 1H 330J-T	T	12.7/16.9
C830	4030017570	S.CER C1005 CH 1H 040B-T	T	11.8/17.7
C831	4030017570	S.CER C1005 CH 1H 040B-T	T	11.8/19.3
C832	4030017590	S.CER C1005 CH 1H 070C-T	T	10.3/19.1
C833	4030017610	S.CER C1005 CH 1H 090C-T	T	8.5/19.2
C834	4030017350	S.CER C1005 CH 1H 020B-T	T	8.0/17.9
C835	4030017580	S.CER C1005 CH 1H 060C-T	T	7.1/19.6
C838	4030017460	S.CER C1005 JB 1H 102K-T	T	5.4/19.6
C839	4030017780	S.CER C1005 JB 1H 472K-T	T	25.5/14.6
C840	4030017460	S.CER C1005 JB 1H 102K-T	T	6.6/15.7
C841	4030006860	S.CER C1608 JB 1H 102K-T	B	5.1/15.4
C851	4030017780	S.CER C1005 JB 1H 472K-T	T	4.5/14.0
C901	4030017780	S.CER C1005 JB 1H 472K-T	T	2.4/68.4
C902	4030017430	S.CER C1005 CH 1H 101J-T	T	16.0/53.3
C951	4030016930	S.CER C1005 JB 1A 104K-T	T	52.3/38.2
C952	4030011600	S.CER C1608 JB 1E 104K-T	T	58.3/47.0
C953	4030016930	S.CER C1005 JB 1A 104K-T	T	54.1/18.4
C954	4030017780	S.CER C1005 JB 1H 472K-T	T	54.2/28.1
C955	4030016930	S.CER C1005 JB 1A 104K-T	T	52.9/33.3
C956	4030016930	S.CER C1005 JB 1A 104K-T	T	49.2/21.0
C957	4030016930	S.CER C1005 JB 1A 104K-T	T	53.9/36.0
C958	4030017780	S.CER C1005 JB 1H 472K-T	T	52.9/34.2
C959	4030017780	S.CER C1005 JB 1H 472K-T	T	52.9/35.1
C960	4030016930	S.CER C1005 JB 1A 104K-T	T	53.5/39.0
C961	4030016930	S.CER C1005 JB 1A 104K-T	T	52.3/39.8
C962	4030016930	S.CER C1005 JB 1A 104K-T	T	52.3/44.6
C963	4030016930	S.CER C1005 JB 1A 104K-T	T	53.5/38.1
C964	4030017460	S.CER C1005 JB 1H 102K-T	T	55.0/44.8
C966	4030016930	S.CER C1005 JB 1A 104K-T	T	52.3/41.4
C967	4030016930	S.CER C1005 JB 1A 104K-T	T	52.3/43.0
C968	4030018960	S.CER C3216 JB 1C 106MT-N	B	42.1/44.0
C969	4030006880	S.CER C1608 JB 1H 472K-T	B	48.2/23.1
C972	4030018970	S.CER C3225 JB 1C 226MT-N	B	42.2/3.6
C973	4030018970	S.CER C3225 JB 1C 226MT-N	B	29.0/2.8
C974	4030018970	S.CER C3225 JB 1C 226MT-N	B	32.0/2.8
C975	4550007140	S.TAN TEESVD 1C 107M12R	B	16.7/4.1
C976	4550007140	S.TAN TEESVD 1C 107M12R	B	23.5/10.5
C977	4550007140	S.TAN TEESVD 1C 107M12R	B	23.6/19.5
C978	4550007140	S.TAN TEESVD 1C 107M12R	B	32.3/10.5
C980	4030004720	S.CER C2012 JB 1H 102K-T	B	55.6/11.0
C981	4030016930	S.CER C1005 JB 1A 104K-T	T	54.5/12.6
C982	4030006860	S.CER C1608 JB 1H 102K-T	B	14.0/67.2
C983	4030006860	S.CER C1608 JB 1H 102K-T	B	7.5/74.0
C991	4030006860	S.CER C1608 JB 1H 102K-T	B	10.0/68.1
C992	4030006860	S.CER C1608 JB 1H 102K-T	B	7.2/67.3
C993	4030006860	S.CER C1608 JB 1H 102K-T	B	4.3/74.0
C994	4030006860	S.CER C1608 JB 1H 102K-T	B	5.6/71.4
C995	4030006860	S.CER C1608 JB 1H 102K-T	B	2.2/59.2
C996	4030006860	S.CER C1608 JB 1H 102K-T	B	5.1/58.8
C997	4030006860	S.CER C1608 JB 1H 102K-T	B	2.9/55.0
C998	4030006860	S.CER C1608 JB 1H 102K-T	B	3.1/62.6
C1001	4030011600	S.CER C1608 JB 1E 104K-T	T	58.4/48.4
C1051	4030006880	S.CER C1608 JB 1H 472K-T	B	20.2/65.4
C1052	4030006880	S.CER C1608 JB 1H 472K-T	B	19.2/60.3
C1101	4030017780	S.CER C1005 JB 1H 472K-T	T	39.0/52.2
C1102	4030017780	S.CER C1005 JB 1H 472K-T	T	44.2/50.4
C1104	4030017780	S.CER C1005 JB 1H 472K-T	T	42.2/62.2
C1105	4030017780	S.CER C1005 JB 1H 472K-T	T	40.6/59.9
C1106	4030017780	S.CER C1005 JB 1H 472K-T	T	40.4/55.9
C1107	4030017780	S.CER C1005 JB 1H 472K-T	T	43.3/57.0
C1108	4030017460	S.CER C1005 JB 1H 102K-T	T	40.1/62.2
C1109	4030006880	S.CER C1608 JB 1H 472K-T	B	35.1/76.9
C1110	4030017780	S.CER C1005 JB 1H 472K-T	T	33.5/59.6
C1111	4030017780	S.CER C1005 JB 1H 472K-T	T	29.7/59.6
C1112	4030017780	S.CER C1005 JB 1H 472K-T	T	38.2/63.4
C1113	4030017780	S.CER C1005 JB 1H 472K-T	T	37.1/59.7
C1114	4030017780	S.CER C1005 JB 1H 472K-T	T	24.4/60.7
C1115	4030017780	S.CER C1005 JB 1H 472K-T	T	35.3/59.8
C1116	4030017460	S.CER C1005 JB 1H 102K-T	T	23.2/63.8
C1117	4030006860	S.CER C1608 JB 1H 102K-T	B	21.0/63.9
C1151	4030017780	S.CER C1005 JB 1H 472K-T	T	50.5/66.3
C1152	4030017780	S.CER C1005 JB 1H 472K-T	T	46.4/66.3
C1153	4030017780	S.CER C1005 JB 1H 472K-T	T	43.7/68.2
C1154	4030017780	S.CER C1005 JB 1H 472K-T	T	52.0/66.3
C1155	4030017780	S.CER C1005 JB 1H 472K-T	T	57.9/68.3
RL1101	6330001721	REL ATN207-K1		
J151	6510028210	CON SJ050010 (TMP-J01X-V6)		
J851	6510018450	CON TMP-S01X-B1		
J951	6510024880	S.CON 52689-3087	T	59.3/35.4
J952	6510024880	S.CON 52689-3087	T	59.3/12.5
J1001	6510003521	CON S04B-EH-S(LF)(SN)		
J1051	6510028070	CON 01J0377-00		
J1101	6450001641	CON TCS5044-0141177		
J1151	6450001841	CON TCS7568-4320177		
EP6	6910012350	S.BEA MMZ1608Y 102BT	B	12.9/11.1
EP251	6910012350	S.BEA MMZ1608Y 102BT	B	33.1/18.7
EP301	6910012350	S.BEA MMZ1608Y 102BT	B	49.8/25.0
EP302	6910012350	S.BEA MMZ1608Y 102BT	B	32.9/27.8
EP303	6910012350	S.BEA MMZ1608Y 102BT	B	32.9/26.1
EP305	6910012350	S.BEA MMZ1608Y 102BT	B	41.1/27.2
EP306	6910012350	S.BEA MMZ1608Y 102BT	B	36.6/26.4
EP451	6910012350	S.BEA MMZ1608Y 102BT	B	39.9/47.9

[DDS UNIT]

REF NO.	PARTS NO.	DESCRIPTION	M.	H/V LOCATION
EP809	6910012350	S.BEA MMZ1608Y 102BT	B	16.7/7.2
EP951	6910012350	S.BEA MMZ1608Y 102BT	B	53.3/24.4
EP952	6910012350	S.BEA MMZ1608Y 102BT	B	50.6/21.8
EP953	6910012350	S.BEA MMZ1608Y 102BT	T	54.0/43.4
EP954	6910012350	S.BEA MMZ1608Y 102BT	T	54.0/42.1
EP955	6910012350	S.BEA MMZ1608Y 102BT	T	54.2/40.0
EP956	6910012350	S.BEA MMZ1608Y 102BT	T	54.7/37.0
EP957	6910012350	S.BEA MMZ1608Y 102BT	B	39.6/46.1
EP958	6910012350	S.BEA MMZ1608Y 102BT	B	55.9/47.4
EP959	6910012350	S.BEA MMZ1608Y 102BT	B	56.7/32.5
EP960	6910012350	S.BEA MMZ1608Y 102BT	B	56.9/28.4
EP964	6910012350	S.BEA MMZ1608Y 102BT	B	53.4/22.2
EP981	6910012350	S.BEA MMZ1608Y 102BT	T	55.3/14.3
EP1003	6910018930	S.BEA MPZ2012S601A	T	57.3/50.3
EP1004	6910018930	S.BEA MPZ2012S601A	T	53.9/50.0
EP1051	6910012350	S.BEA MMZ1608Y 102BT	B	20.2/66.8
EP1052	6910012350	S.BEA MMZ1608Y 102BT	B	19.2/58.7
EP1100	6910012350	S.BEA MMZ1608Y 102BT	B	38.7/63.4
EP1101	6910012350	S.BEA MMZ1608Y 102BT	T	27.5/63.3
EP1102	6910012350	S.BEA MMZ1608Y 102BT	T	34.4/62.4
EP1103	6910012350	S.BEA MMZ1608Y 102BT	T	51.1/69.2
EP1104	6910012350	S.BEA MMZ1608Y 102BT	T	56.1/69.2
EP1105	6910014730	S.BEA MPZ2012S331A-T	B	41.0/67.9
EP1106	6910014730	S.BEA MPZ2012S331A-T	B	34.7/61.8
EP1107	6910014730	S.BEA MPZ2012S331A-T	B	31.4/61.8
EP1108	6910014730	S.BEA MPZ2012S331A-T	B	27.1/73.6

M.=Mounted side (T: Mounted on the Top side, B: Mounted on the Bottom side)
S.=Surface mount

The combination of this side and the bottom side shows the board layout in the same configuration as the actual P.C.Board.

• PA UNIT
(BOTTOM VIEW)

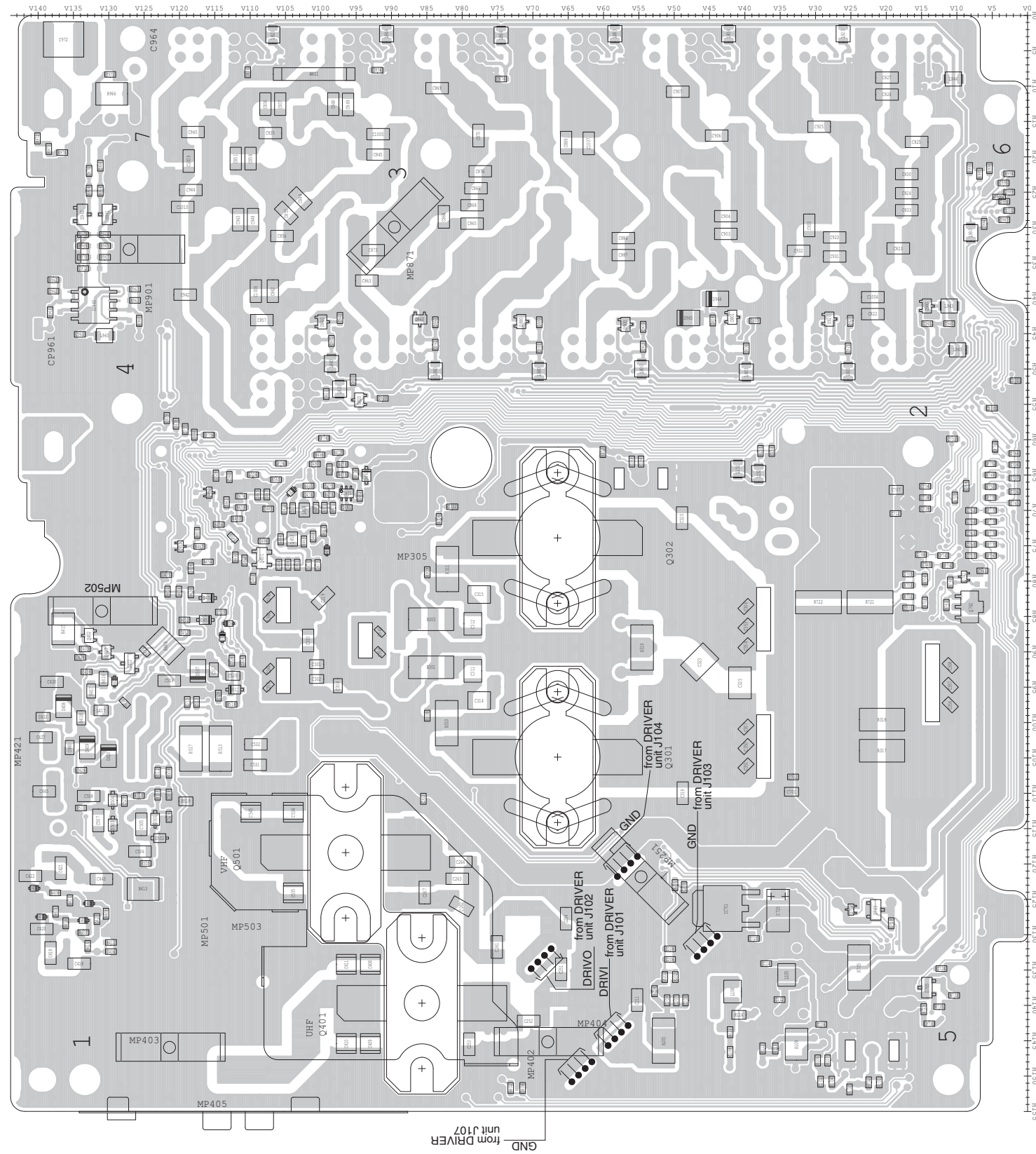

• LOGIC UNIT
(BOTTOM VIEW)

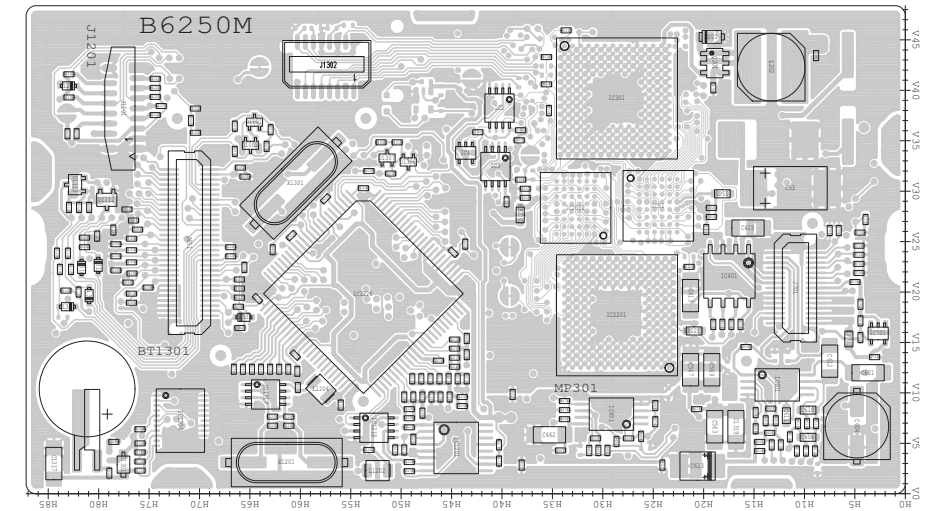

J651

60	1DST	VDL	1
	3DST	MMDK	
	PDT	SQSS	
	PCK	DOTK	
	TCNO	DASK	
	TCN1	WFML	
	PRES#	LTXD	
	LOST	LTXD	
	RS_RXD	CIV	
	RS_TXD	CIVE	
	MST	START	
	MDT	KEY	
	MCK	MUDL	
	NC	FOPL	
	SNDS	REFL	
	SDSS	ALCL	
	2TBV	SNDL	
	4TBV	DPTL	
	TXS	THML	
	RXS	CPU_P12	
	POWS	RTK1	
	VOUT	CPU_P22	
	PWRK	CPU_P94	
	GND	CPU_P95	
	GND	IMR	
	GND	CPU_PF6	
	GND	MMSL	
	GND	NC	
	GND	IMR2	
31	GND	NC	30

to MAIN unit J2252

J701

15	GND	AFMS	16
	DSP02	MOSI	
	GND	SCK	
	DSP01	VSTB	
	GND	NC	
	DOUT	NC	
	GND	NC	
	NC	24M	
	GND	HV	
	GND	8V	
	GND	8V	
	GND	5V	
	DSP11	5V	
	GND	3V	
1	DSP12	3V	30

to MAIN unit J2251

VOLTAGE DIAGRAM

• DISPLAY UNIT

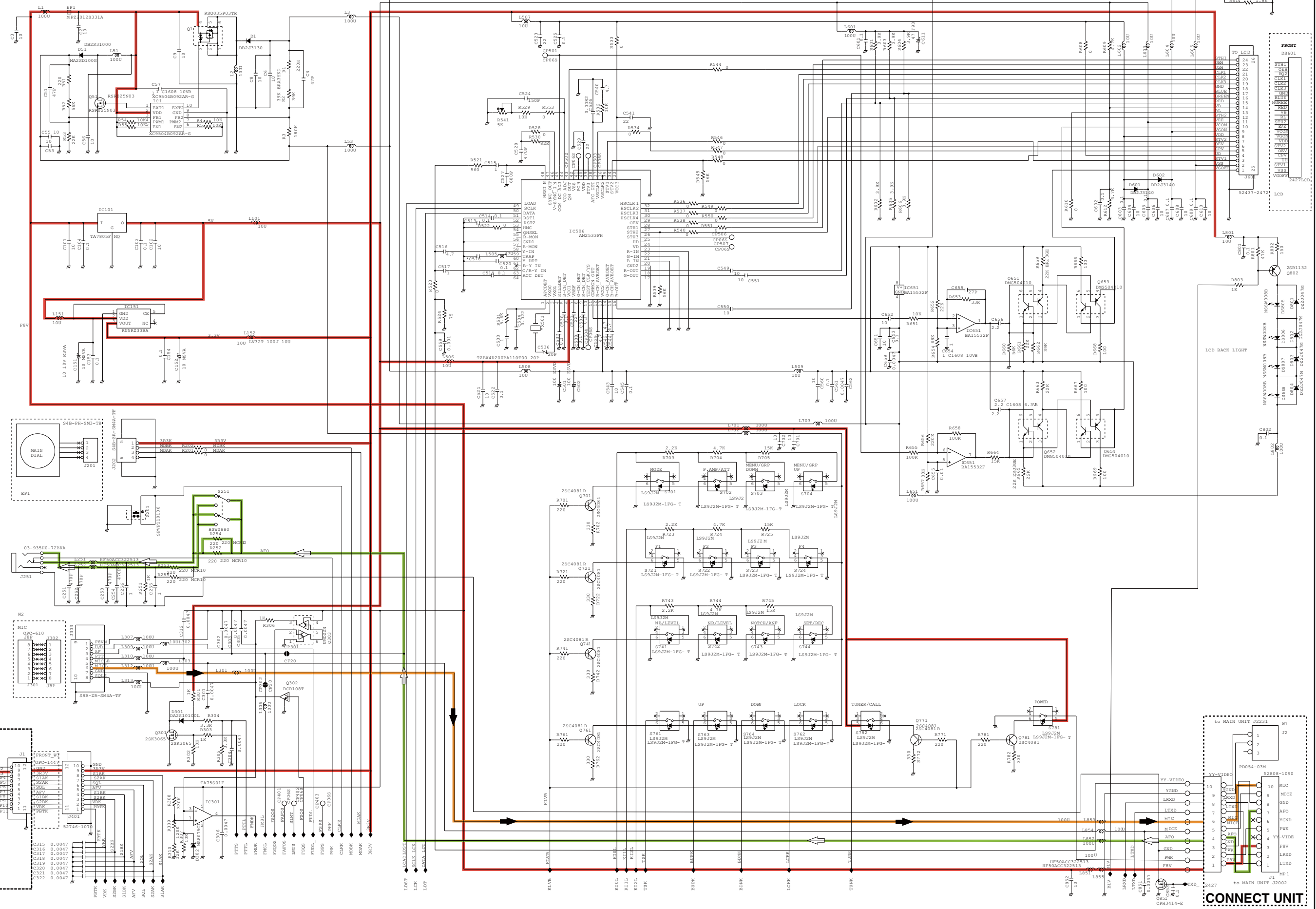

*; Refer to "PARTS LIST."

• LOGIC UNIT (1/3)

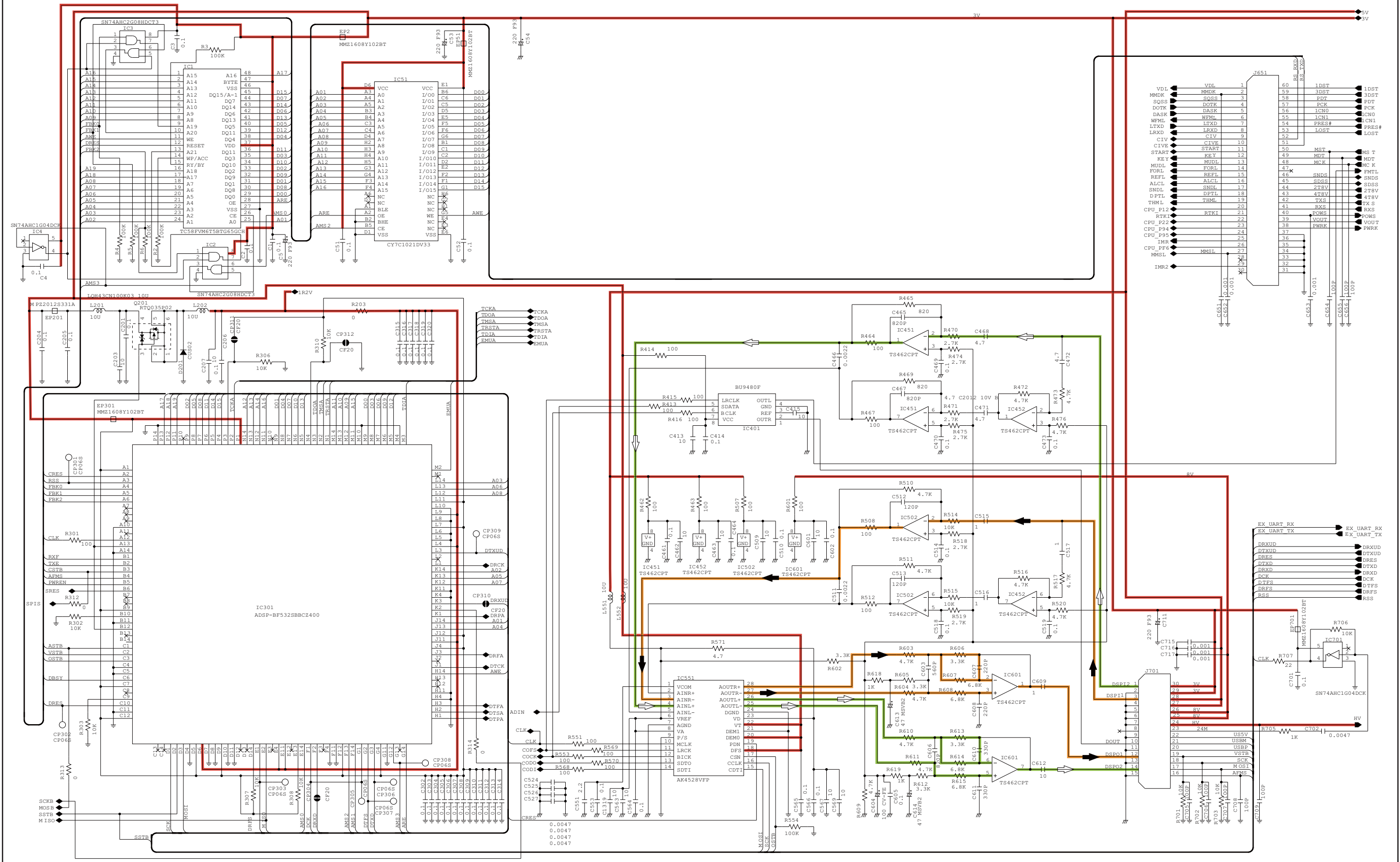

*; Refer to "PARTS LIST"

• LOGIC UNIT (2/3)

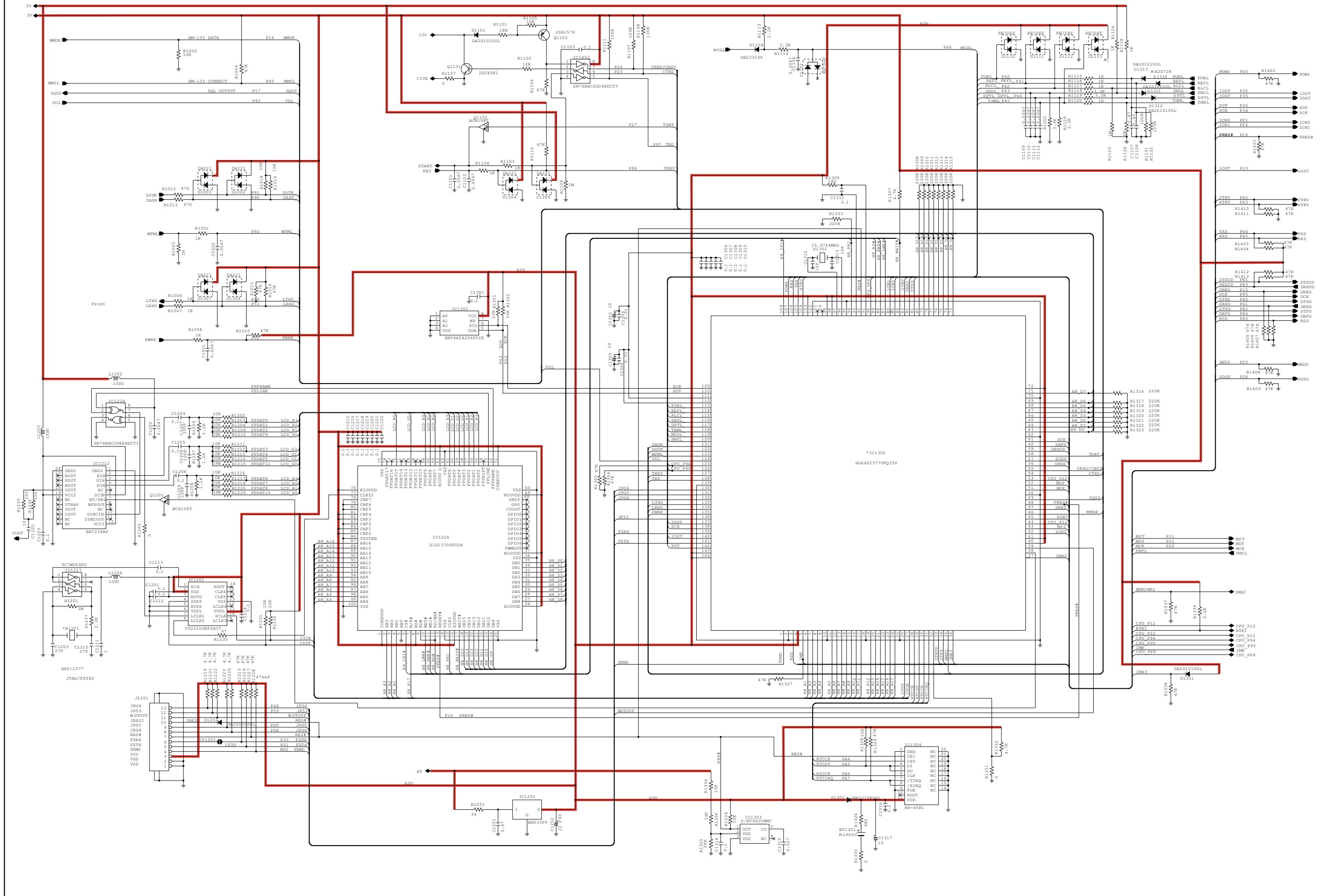

*; Refer to "PARTS LIST."

• MAIN UNIT (Left side)

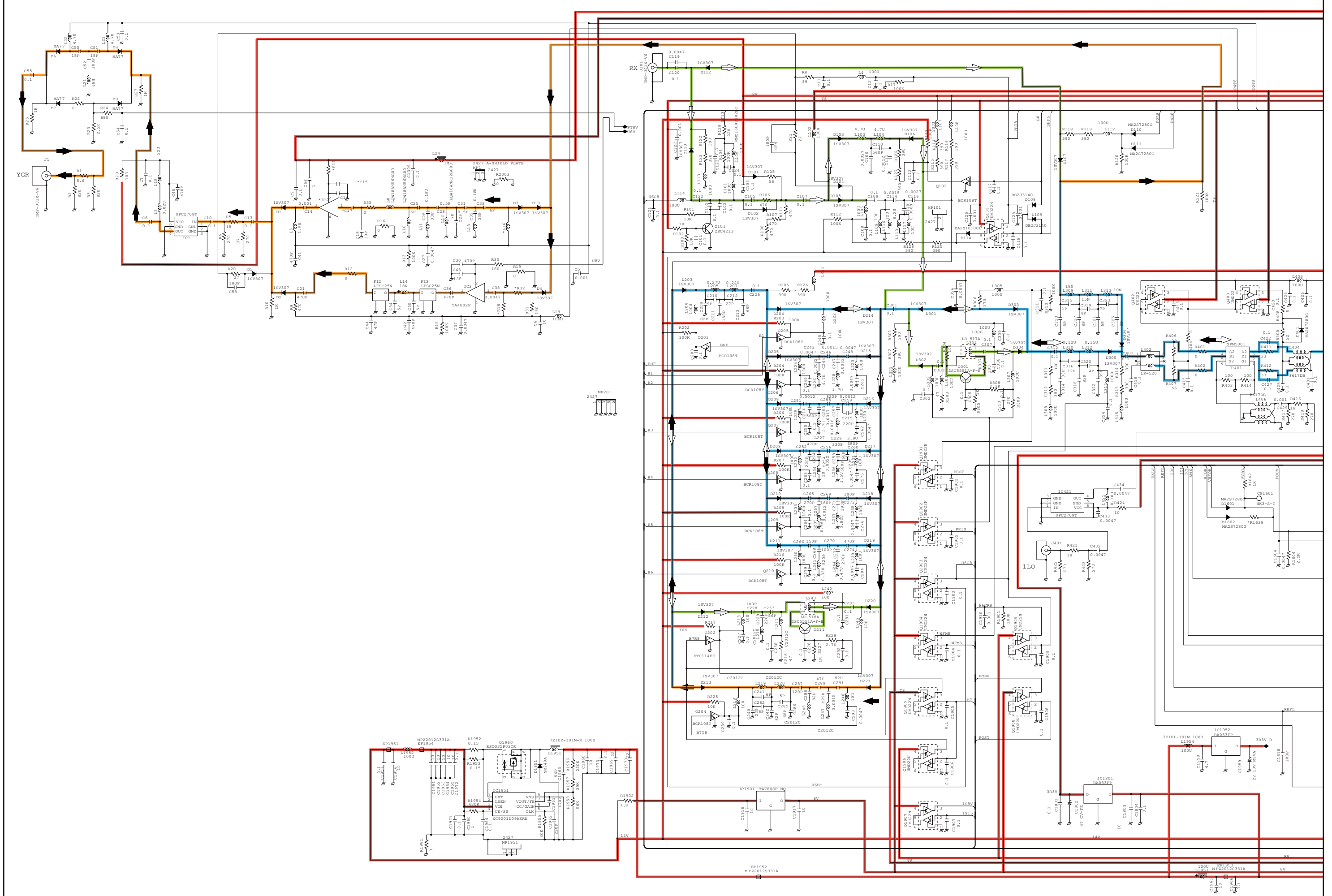

*; Refer to "PARTS LIST."

• MAIN UNIT (Right side)

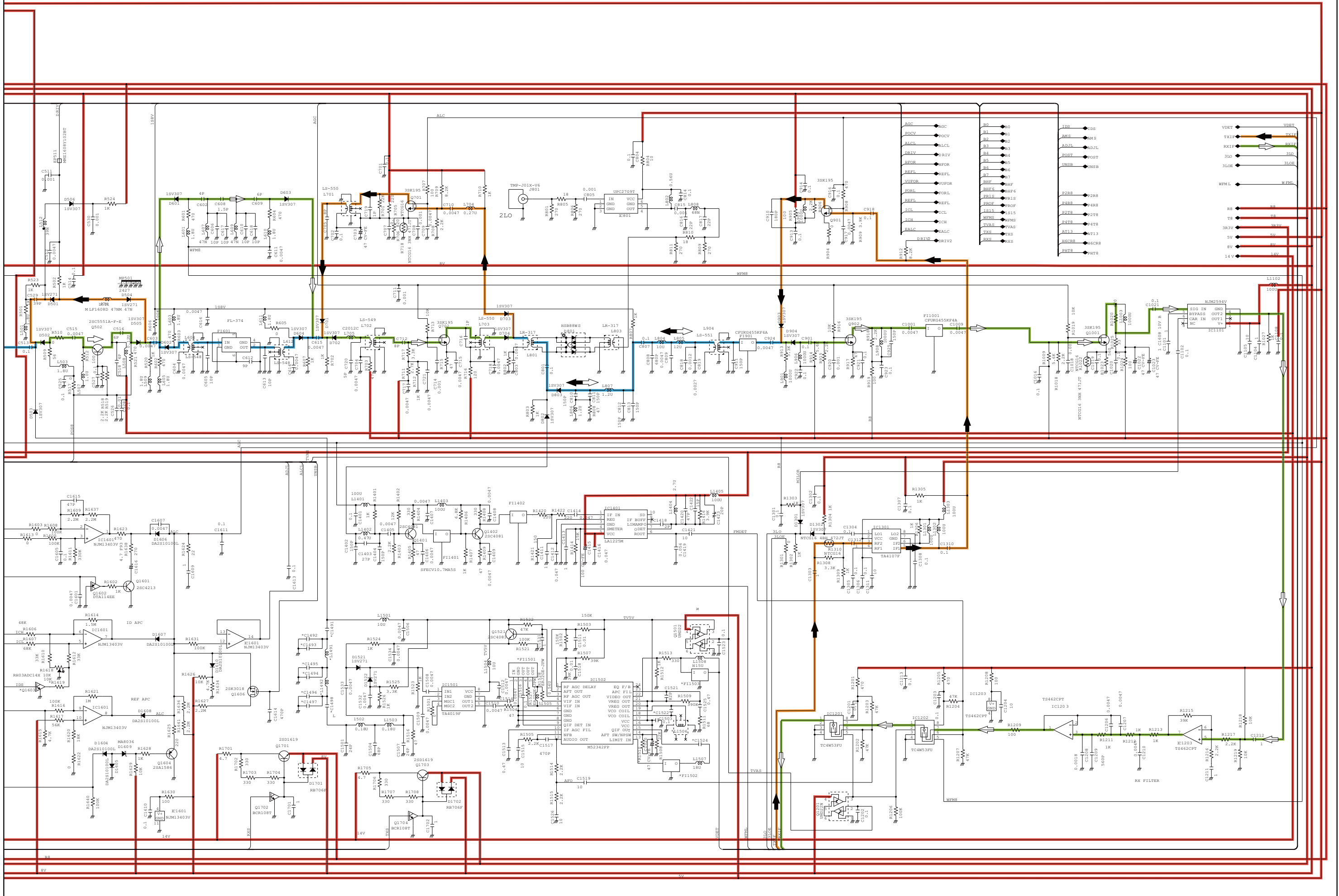

*; Refer to "PARTS LIST"

• PA UNIT (1/2)

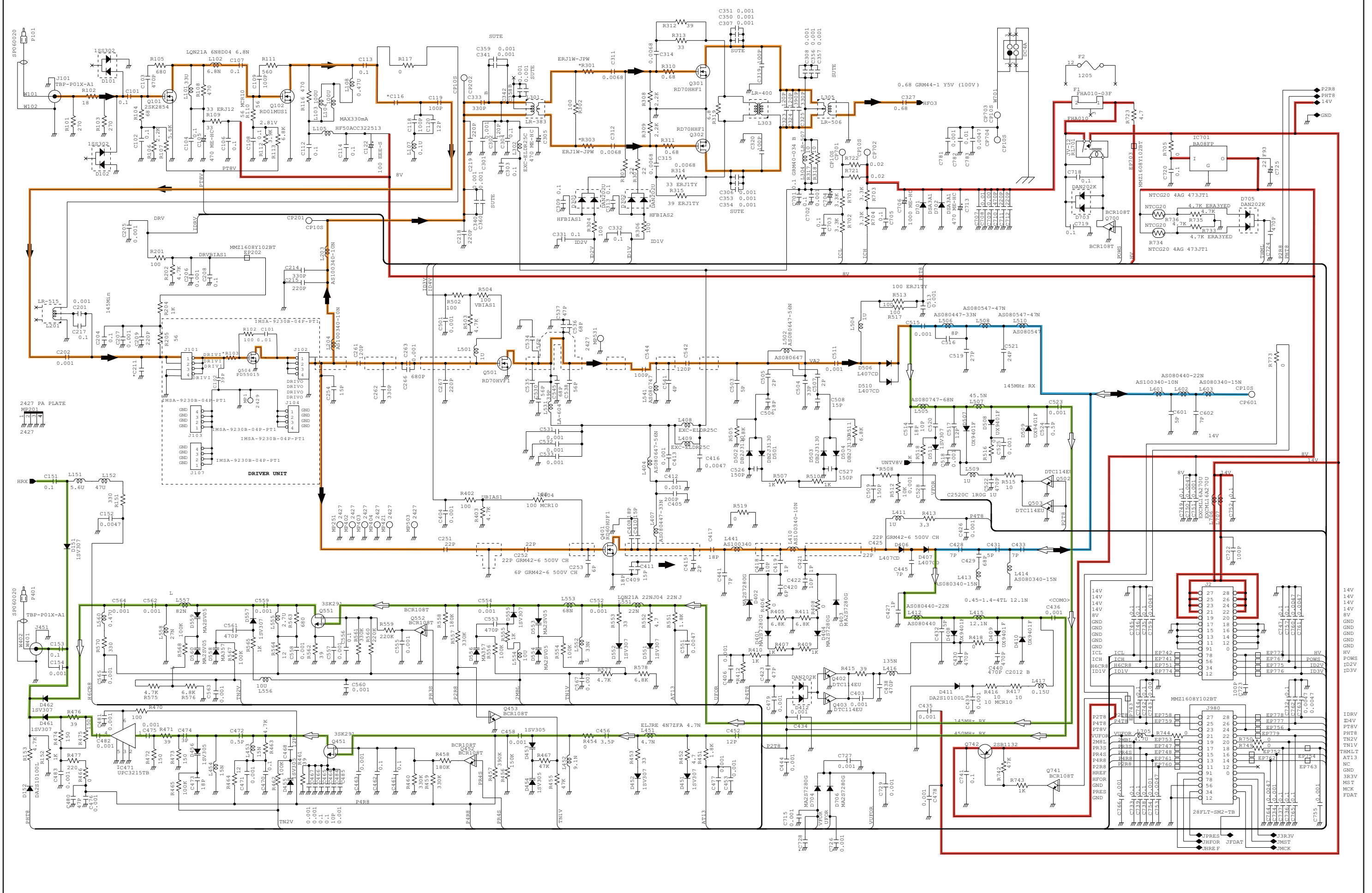

• PA UNIT (2/2)

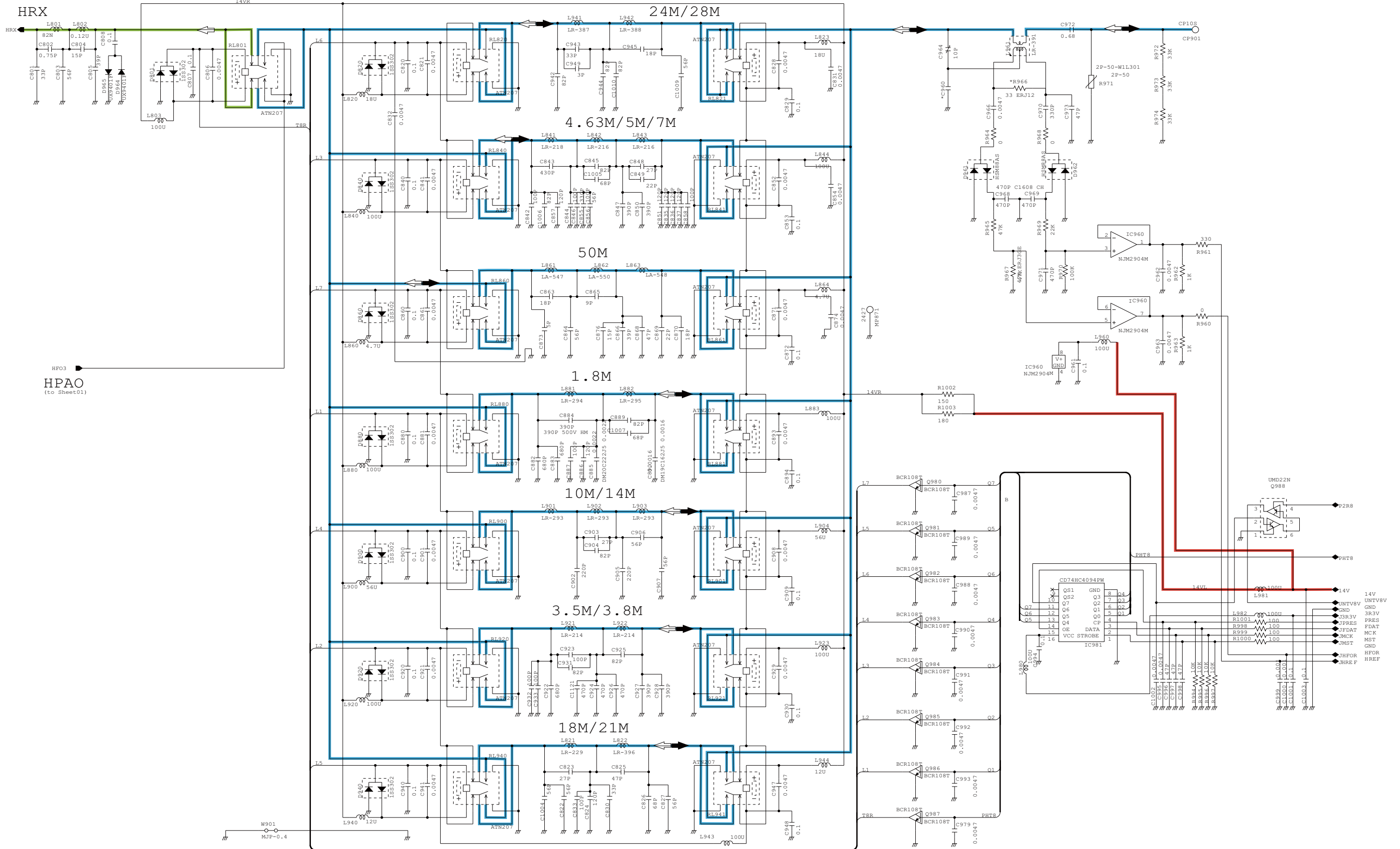

*; Refer to "PARTS LIST."

Jan. 2010



SERVICE MANUAL ADDENDUM

IC-7000

CONTENTS

PARTS LIST	1
BOARD LAYOUTS	27
VOLTAGE DIAGRAM	29

PARTS LIST

[MAIN UNIT]

REF NO.	PARTS NO.	DESCRIPTION	M.	H/V LOCATION
IC1	1110004080	S.IC UPC2709TE3	T	75.6/12.7
IC2	1110004101	S.IC TA4001F (TE85L,F)	T	64/18.8
IC3	1110004091	S.IC TA4002F (TE85L,F)	T	48.3/17.4
IC401	1190002051	S.IC SPM5001-TL-E [FRA]	T	77.5/27.9
	1190002051	S.IC SPM5001-TL-E [KOR]		
	1190002051	S.IC SPM5001-TL-E [AUS]		
	1190002052	S.IC SPM5001-TL-E (7000) [EUR]		
	1190002052	S.IC SPM5001-TL-E (7000) [ESP]		
	1190002052	S.IC SPM5001-TL-E (7000) [USA]		
	1190002052	S.IC SPM5001-TL-E (7000) [EXP]		
	1190002052	S.IC SPM5001-TL-E (7000) [ITR]		
	1190002052	S.IC SPM5001-TL-E (7000) [UK]		
	1190002052	S.IC SPM5001-TL-E (7000) [CHN]		
IC421	1110004080	S.IC UPC2709TE3	T	86.4/19.4
IC801	1110004080	S.IC UPC2709TE3	T	86/57.4
IC1101	1110006730	S.IC NJM2594V-TE1-#ZZZB	T	5/83.3
IC1201	1130006221	S.IC TC4W53FU(TE12L,F)	T	24.2/81.6
IC1202	1130006221	S.IC TC4W53FU(TE12L,F)	T	19.8/81.4
IC1203	1110006570	S.IC TS462CPT	T	12.8/81.7
IC1301	1110005461	S.IC TA4107F(TE12L,F)	T	13.7/63.4
IC1401	1110006541	S.IC LA1225M-TLM-E	B	23.4/82.2
IC1501	1110006530	S.IC TA4019F(TE12L,F)	B	74.8/39
IC1502	1110005040	S.IC M52342FP 600C	B	79.7/57
IC1601	1110005320	S.IC NJM13403V-TE1-#ZZZB	T	8.6/41.5
IC1801	1180002020	S.REG BA033FP-E2	B	22.8/106.5
IC1901	1180001252	S.IC TA7808F(TE16L1,NQ)	B	10.4/55.2
IC1951	1190002120	S.IC XC9201D09AKR	B	41.9/107.8
IC1952	1180002020	S.REG BA033FP-E2	B	14.7/125.8
IC2001	1180001252	S.IC TA7808F(TE16L1,NQ)	B	8.5/19
IC2007	1110006570	S.IC TS462CPT	T	15.8/121
IC2101	1110005320	S.IC NJM13403V-TE1-#ZZZB	T	28.5/118
IC2102	1110005320	S.IC NJM13403V-TE1-#ZZZB	T	49.5/111.9
IC2103	1110005140	S.IC NJM3403AV-TE1-#ZZZB	T	49.5/121.2
IC2151	1130012720	S.IC CD74HC4094PWR	T	47.1/95.9
IC2152	1130012720	S.IC CD74HC4094PWR	T	37.9/95.9
IC2153	1130012720	S.IC CD74HC4094PWR	T	28.1/95.8
IC2154	1130012720	S.IC CD74HC4094PWR	T	28.2/101.5
IC2155	1110006680	S.IC BH2221FV-E2	T	38.2/118.1
IC2156	1130009100	S.IC BU4052BCFV-E2	T	10.1/107.6
IC2231	1110006640	S.IC NJM2244M-TE1-#ZZZB	T	34.7/109.4
IC2251	1130008511	S.IC TC7W53FU(TE12L,F)	T	16.7/89.5
IC2501	1110006570	S.IC TS462CPT	B	12.7/91.7
IC2551	1110006570	S.IC TS462CPT	B	49.2/122
IC2601	1130006221	S.IC TC4W53FU(TE12L,F)	B	63.2/123.9
IC2602	1110003091	IC LA4425A-E		
Q101	1530003091	S.TRA 2SC4213-B(TE85R,F)	T	11.2/17.5
Q102	1590003940	S.TRA RN1105(TE85L,F)	T	20.7/5.6
Q103	1590003930	S.TRA UMD22N TR	T	38.4/20.2
Q201	1590003940	S.TRA RN1105(TE85L,F)	T	16.1/31.1
Q202	1590002310	S.TRA DTC114EE TL	T	23.5/28.5
Q204	1590003940	S.TRA RN1105(TE85L,F)	B	44.7/38.6
Q205	1590003940	S.TRA RN1105(TE85L,F)	T	42.9/61.5
Q206	1590003940	S.TRA RN1105(TE85L,F)	B	24.5/55
Q207	1590003940	S.TRA RN1105(TE85L,F)	B	24.5/51.9
Q208	1590003940	S.TRA RN1105(TE85L,F)	B	24.2/48.8
Q209	1590003940	S.TRA RN1105(TE85L,F)	B	23.5/45.7
Q210	1590003940	S.TRA RN1105(TE85L,F)	B	42.9/41.4
Q211	1530003851	S.TRA 2SC5551F-TD-E	T	27.6/30.1
Q301	1530003851	S.TRA 2SC5551F-TD-E	T	56.7/32.4
Q402	1590003930	S.TRA UMD22N TR	T	82.8/22.8
Q403	1590003930	S.TRA UMD22N TR	T	69.7/23.6
Q502	1530003851	S.TRA 2SC5551F-TD-E	T	83/37.1
Q701	1580000780	S.FET 3SK195(TE85L,F)	T	62/56.8
Q702	1580000780	S.FET 3SK195(TE85L,F)	T	54.6/51.8
Q901	1580000780	S.FET 3SK195(TE85L,F)	T	36.6/65.7
Q902	1580000780	S.FET 3SK195(TE85L,F)	T	35.9/73.2
Q1001	1580000780	S.FET 3SK195(TE85L,F)	T	17.9/76
Q1201	1590003930	S.TRA UMD22N TR	T	28/78.6
Q1401	1530002060	S.TRA 2SC4081 T106 R	B	42.5/74.3
Q1402	1530002060	S.TRA 2SC4081 T106 R	B	36.7/80.1
Q1501	1590004030	S.TRA KRX204U-RTK/P	T	30.6/78.5
Q1521	1530002060	S.TRA 2SC4081 T106 R	B	85.9/47.5
Q1601	1530003091	S.TRA 2SC4213-B(TE85R,F)	T	8.3/52.9
Q1602	1590001870	S.TRA DTA114EE TL	T	4.5/53
Q1603	1590003940	S.TRA RN1105(TE85L,F)	T	2.8/40.7
Q1604	1510000771	S.TRA 2SA1586-GR(TE85L,F)	T	5.1/32.7
Q1606	1560001260	S.FET 2SK3018 T106	T	12.5/36.8
Q1701	1540000441	S.TRA 2SD1619T-TD-E	B	52.4/48.2
Q1702	1590003940	S.TRA RN1105(TE85L,F)	B	54.3/52.1
Q1703	1540000441	S.TRA 2SD1619T-TD-E	B	52.4/67.4
Q1704	1590003940	S.TRA RN1105(TE85L,F)	B	54.1/72.9
Q1901	1590003930	S.TRA UMD22N TR	T	35.8/78.5
Q1902	1590003930	S.TRA UMD22N TR	T	33.3/78.5
Q1903	1590003930	S.TRA UMD22N TR	B	23.6/17
Q1904	1590003930	S.TRA UMD22N TR	B	32.9/87.9
Q1905	1590003930	S.TRA UMD22N TR	B	46/40.9
Q1906	1590003930	S.TRA UMD22N TR	B	26.3/30.8
Q1907	1590003930	S.TRA UMD22N TR	T	40.9/78.5
Q1908	1590003930	S.TRA UMD22N TR	T	38.3/78.5
Q1909	1590003930	S.TRA UMD22N TR	B	22.1/11.8

[MAIN UNIT]

REF NO.	PARTS NO.	DESCRIPTION	M.	H/V LOCATION
Q1960	1550000090	S.FET RSQ035P03TR	B	37.9/103.6
Q2150	1590003930	S.TRA UMD22N TR	T	48.4/100.1
Q2151	1520000460	S.TRA 2SB1132 T100 R	T	55.3/103.8
Q2152	1520000460	S.TRA 2SB1132 T100 R	T	21.3/111
Q2153	1520000460	S.TRA 2SB1132 T100 R	T	49.8/104.5
Q2154	1590003930	S.TRA UMD22N TR	T	44.7/100.1
Q2155	1590003930	S.TRA UMD22N TR	T	39.9/100.1
Q2156	1590003940	S.TRA RN1105(TE85L,F)	T	58.9/104.5
Q2157	1590003940	S.TRA RN1105(TE85L,F)	T	25.4/109.7
Q2158	1590003940	S.TRA RN1105(TE85L,F)	T	45.5/107.1
Q2159	1590003930	S.TRA UMD22N TR	T	6.7/118.2
Q2160	1590003930	S.TRA UMD22N TR	T	7.7/122.2
Q2231	1590003940	S.TRA RN1105(TE85L,F)	T	4.7/121.7
Q2232	1590003930	S.TRA UMD22N TR	T	57.3/114.8
Q2233	1590003930	S.TRA UMD22N TR	T	54.7/115.7
Q2301	1530002060	S.TRA 2SC4081 T106 R	T	30.6/109
Q2401	1540000441	S.TRA 2SD1619T-TD-E	B	80.1/26.4
Q2601	1560001260	S.FET 2SK3018 T106	B	36.2/124.6
Q2602	1560001221	S.FET ECH8301 TL-E	B	37.3/127.6
Q2603	1530002060	S.TRA 2SC4081 T106 R	T	65.3/111.3
Q2605	1590003940	S.TRA RN1105(TE85L,F)	T	11.7/112.7
Q2606	1540000451	S.TRA 2SD1623T-TD-E	B	89.5/119.9
Q2607	1590003940	S.TRA RN1105(TE85L,F)	B	65.4/120.5
Q2608	1590003940	S.TRA RN1105(TE85L,F)	B	45/128.6
D1	1750000581	S.DIO 1SV307(TPH3,F)	T	70.1/16.6
D2	1750000581	S.DIO 1SV307(TPH3,F)	T	70.3/14.8
D3	1750000581	S.DIO 1SV307(TPH3,F)	T	45.2/19.8
D4	1750000581	S.DIO 1SV307(TPH3,F)	T	41.9/19
D5	1750000581	S.DIO 1SV307(TPH3,F)	T	70.3/18.3
D6	1790000620	S.DIO MA77(TX)	B	79.8/17.1
D7	1790000620	S.DIO MA77(TX)	T	78/15.8
D8	1790000620	S.DIO MA77(TX)	B	81.5/10.6
D9	1790000620	S.DIO MA77(TX)	T	79/11.5
D10	1750000581	S.DIO 1SV307(TPH3,F)	T	42.4/20.9
D101	1750000581	S.DIO 1SV307(TPH3,F)	T	13.3/22.5
D102	1750000581	S.DIO 1SV307(TPH3,F)	T	15.7/19.2
D103	1750000581	S.DIO 1SV307(TPH3,F)	T	20.3/8.7
D104	1750000581	S.DIO 1SV307(TPH3,F)	T	34.7/17.9
D105	1750000581	S.DIO 1SV307(TPH3,F)	T	23.1/12.7
D106	1750000581	S.DIO 1SV307(TPH3,F)	T	29.6/21
D107	1750000581	S.DIO 1SV307(TPH3,F)	T	44/23.6
D108	1750000951	S.DIO MA2J7320GL	B	27.1/18.2
D109	1750000951	S.DIO MA2J7320GL	B	24.7/20.3
D110	1790001241	S.DIO MA2S7280GL	B	51.6/26.4
D111	1790001241	S.DIO MA2S7280GL	B	51.6/24.7
D112	1750000581	S.DIO 1SV307(TPH3,F)	T	15.7/20.9
D113	1750000581	S.DIO 1SV307(TPH3,F)	T	10.2/19.7
D114	1790001251	S.DIO MA2S1110GL	T	35.7/21.3
D203	1750000581	S.DIO 1SV307(TPH3,F)	T	19.3/35.7
D204	1750000581	S.DIO 1SV307(TPH3,F)	T	25.7/58.2
D205	1750000581	S.DIO 1SV307(TPH3,F)	T	25.7/56.3
D208	1750000581	S.DIO 1SV307(TPH3,F)	T	25.7/53.4
D209	1750000581	S.DIO 1SV307(TPH3,F)	T	25.7/50.6
D210	1750000581	S.DIO 1SV307(TPH3,F)	T	25.7/47.7
D211	1750000581	S.DIO 1SV307(TPH3,F)	T	25.7/44.8
D212	1750000581	S.DIO 1SV307(TPH3,F)	T	25.7/39.2
D213	1750000581	S.DIO 1SV307(TPH3,F)	T	25.7/41.5
D214	1750000581	S.DIO 1SV307(TPH3,F)	T	47.7/59.3
D215	1750000581	S.DIO 1SV307(TPH3,F)	T	47.7/56.3
D216	1750000581	S.DIO 1SV307(TPH3,F)	T	47.9/53.6
D217	1750000581	S.DIO 1SV307(TPH3,F)	T	47.8/49.7
D218	1750000581	S.DIO 1SV307(TPH3,F)	B	41.7/47.2
D219	1750000581	S.DIO 1SV307(TPH3,F)	B	38.9/41.6
D220	1750000581	S.DIO 1SV307(TPH3,F)	B	44.6/28.5
D221	1750000581	S.DIO 1SV307(TPH3,F)	B	40.4/36
D301	1750000581	S.DIO 1SV307(TPH3,F)	T	47.3/28.5
D302	1750000581	S.DIO 1SV307(TPH3,F)	T	49.5/30.3
D303	1750000581	S.DIO 1SV307(TPH3,F)	T	64.1/29.9
D304	1750000581	S.DIO 1SV307(TPH3,F)	T	62.4/35.2
D305	1750000581	S.DIO 1SV307(TPH3,F)	T	73.3/35.2
D306	1750000581	S.DIO 1SV307(TPH3,F)	T	64.5/25.7
D401	1790001241	S.DIO MA2S7280GL	T	86.6/24.9
D501	1750000531	S.DIO 1SV271(TPH3,F)	T	90.6/32.2
D502	1750000581	S.DIO 1SV307(TPH3,F)	T	86.2/31.4
D503	1750000581	S.DIO 1SV307(TPH3,F)	T	89.4/29.7
D504	1750000531	S.DIO 1SV271(TPH3,F)	T	89.7/37.7
D505	1750000581	S.DIO 1SV307(TPH3,F)	T	86.7/40.1
D506	1750000581	S.DIO 1SV307(TPH3,F)	B	87.2/35.5
D601	1750000581	S.DIO 1SV307(TPH3,F)	B	90/38.5
D602	1750000581	S.DIO 1SV307(TPH3,F)	T	92.4/41.5
D603	1750000581	S.DIO 1SV307(TPH3,F)	B	76.2/46.5
D604	1750000581	S.DIO 1SV307(TPH3,F)	T	66.7/43.7
D701	1750000581	S.DIO 1SV307(TPH3,F)	T	61.2/43.7
D702	1750000581	S.DIO 1SV307(TPH3,F)	T	65.1/41.3
D703	1750000581	S.DIO 1SV307(TPH3,F)	T	62.7/61.4
D704	1750000581	S.DIO 1SV307(TPH3,F)	T	62.7/63.2
D801	1750000431	S.DIO HSB88WSTR-E	T	74.1/60.3
D802	1750000581	S.DIO 1SV307(TPH3,F)	T	63/73.3
D803	1750000581	S.DIO 1SV307(TPH3,F)	T	65.5/64.6

M.=Mounted side (T: Mounted on the Top side, B: Mounted on the Bottom side)
S.=Surface mount

[MAIN UNIT]

REF NO.	PARTS NO.	DESCRIPTION	M.	H/V LOCATION
D903	1750000581	S.DIO 1SV307(TPH3,F)	T	39.5/69.4
D904	1750000581	S.DIO 1SV307(TPH3,F)	T	39.5/72.8
D1301	1750000581	S.DIO 1SV307(TPH3,F)	T	12.8/72.6
D1302	1750000581	S.DIO 1SV307(TPH3,F)	T	13.9/70.8
D1521	1750000531	S.DIO 1SV271(TPH3,F)	B	79.4/40.7
D1522	1750000531	S.DIO 1SV271(TPH3,F)	B	79.4/42.4
D1601	1790001241	S.DIO MA2S7280GL	T	15.1/48.7
D1602	1790001241	S.DIO MA2S7280GL	T	18.3/53.1
D1604	1790001251	S.DIO MA2S1110GL	T	7.7/31.5
D1605	1790001251	S.DIO MA2S1110GL	T	7.7/32.8
D1606	1790001251	S.DIO MA2S1110GL	T	14.1/44.8
D1607	1790001251	S.DIO MA2S1110GL	T	14.1/43.5
D1608	1790001251	S.DIO MA2S1110GL	T	14.1/42.2
D1609	1790001331	S.ZEN MAZ8036GLL	T	7.5/29.9
D1610	1790001251	S.DIO MA2S1110GL	T	12.3/34.9
D1701	1790001670	S.DIO RB706F-40T106	B	50.2/52.2
D1702	1790001670	S.DIO RB706F-40T106	B	51.8/71.8
D1951	1750001110	S.DIO SM240A-T	B	36.2/99.9
D2151	1790001251	S.DIO MA2S1110GL [USA]	T	39/87.1
	1790001251	S.DIO MA2S1110GL [KOR]		
	1790001251	S.DIO MA2S1110GL [AUS]		
D2153	1790001251	S.DIO MA2S1110GL [USA]	T	36.5/87.1
	1790001251	S.DIO MA2S1110GL [KOR]		
D2154	1790001251	S.DIO MA2S1110GL	T	36.5/88.4
D2155	1790001251	S.DIO MA2S1110GL	T	36.6/89.7
D2156	1790001251	S.DIO MA2S1110GL	T	39/90.5
D2157	1790001251	S.DIO MA2S1110GL [EUR]	T	48.5/87.1
	1790001251	S.DIO MA2S1110GL [ESP]		
	1790001251	S.DIO MA2S1110GL [USA]		
	1790001251	S.DIO MA2S1110GL [EXP]		
	1790001251	S.DIO MA2S1110GL [ITR]		
	1790001251	S.DIO MA2S1110GL [UK]		
	1790001251	S.DIO MA2S1110GL [KOR]		
	1790001251	S.DIO MA2S1110GL [AUS]		
	1790001251	S.DIO MA2S1110GL [CHN]		
D2158	1790001251	S.DIO MA2S1110GL	T	48.5/88.4
D2159	1790001251	S.DIO MA2S1110GL	T	48.5/89.7
D2160	1790001251	S.DIO MA2S1110GL	T	48.5/91
D2162	1790001251	S.DIO MA2S1110GL [USA] only	T	46/88.4
D2163	1790001251	S.DIO MA2S1110GL [EUR]	T	46/89.7
	1790001251	S.DIO MA2S1110GL [FRA]		
	1790001251	S.DIO MA2S1110GL [ESP]		
	1790001251	S.DIO MA2S1110GL [ITR]		
	1790001251	S.DIO MA2S1110GL [UK]		
D2166	1790001251	S.DIO MA2S1110GL [ESP]	T	29.4/88.2
	1790001251	S.DIO MA2S1110GL [KOR]		
D2168	1790001251	S.DIO MA2S1110GL [EUR]	T	29.4/90.6
	1790001251	S.DIO MA2S1110GL [ESP]		
	1790001251	S.DIO MA2S1110GL [ITR]		
	1790001251	S.DIO MA2S1110GL [UK]		
D2169	1790001251	S.DIO MA2S1110GL [AUS]	T	26.9/87.1
	1790001251	S.DIO MA2S1110GL [EUR]		
	1790001251	S.DIO MA2S1110GL [ESP]		
	1790001251	S.DIO MA2S1110GL [USA]		
	1790001251	S.DIO MA2S1110GL [EXP]		
	1790001251	S.DIO MA2S1110GL [ITR]		
	1790001251	S.DIO MA2S1110GL [UK]		
	1790001251	S.DIO MA2S1110GL [KOR]		
D2170	1790001251	S.DIO MA2S1110GL [CHN]	T	26.9/88.4
	1790001251	S.DIO MA2S1110GL [EUR]		
	1790001251	S.DIO MA2S1110GL [USA]		
	1790001251	S.DIO MA2S1110GL [EXP]		
	1790001251	S.DIO MA2S1110GL [ITR]		
	1790001251	S.DIO MA2S1110GL [UK]		
D2171	1790001251	S.DIO MA2S1110GL [FRA]	T	26.9/89.7
	1790001251	S.DIO MA2S1110GL [ESP]		
	1790001251	S.DIO MA2S1110GL [EXP]		
	1790001251	S.DIO MA2S1110GL [UK]		
	1790001251	S.DIO MA2S1110GL [KOR]		
	1790001251	S.DIO MA2S1110GL [CHN]		
D2172	1790001251	S.DIO MA2S1110GL	T	26.9/91
D2173	1790001251	S.DIO MA2S1110GL	T	6.4/120.2
D2174	1790001251	S.DIO MA2S1110GL [EUR]	T	52/88.2
	1790001251	S.DIO MA2S1110GL [FRA]		
	1790001251	S.DIO MA2S1110GL [ESP]		
	1790001251	S.DIO MA2S1110GL [USA]		
	1790001251	S.DIO MA2S1110GL [EXP]		
	1790001251	S.DIO MA2S1110GL [UK]		
	1790001251	S.DIO MA2S1110GL [KOR]		
	1790001251	S.DIO MA2S1110GL [AUS]		
	1790001251	S.DIO MA2S1110GL [CHN]		
D2175	1790001251	S.DIO MA2S1110GL	T	52/87
D2201	1730002341	S.ZEN MAZ8047GML	T	10.5/122.8
D2205	1790001011	S.ZEN MAZ8043GLL	T	13.5/115.2
D2211	1790001011	S.ZEN MAZ8043GLL	T	21.5/118
D2231	1160000070	S.DIO DAN202K T146	T	57.6/117.8
D2232	1790001670	S.DIO RB706F-40T106	T	56.8/112.2
D2401	1160000070	S.DIO DAN202K T146	B	85.7/27.2
D2402	1790001251	S.DIO MA2S1110GL	T	63.5/113.2
D2551	1790001141	S.ZEN MAZ8039GLL	B	45.3/116.5
D2601	1160000070	S.DIO DAN202K T146	B	42/126.3
D2602	1790001251	S.DIO MA2S1110GL	B	41.2/128.5
FI2	2040001420	S.LC LFB32440MSC1-955 (LFSC25N12B0)	T	59.3/13.9

[MAIN UNIT]

REF NO.	PARTS NO.	DESCRIPTION	M.	H/V LOCATION
FI3	2040001420	S.LC LFB32440MSC1-955 (LFSC25N12B0)	T	53.3/13.4
FI601	2010002640	S.XTA DSF753SDF 124.487 MHz (FL-374)	T	81/43.7
FI901	2020002011	S.CER CFUKG455KF4A-R0	T	44.7/69.7
FI1001	2020002011	S.CER CFUKG455KF4A-R0	T	27.8/66.9
FI1401	2020001810	S.CER SFECV10M7FA00-R0 (SFECV10.7MA5S)	B	37.5/76.4
FI1402	2020001810	S.CER SFECV10M7FA00-R0 (SFECV10.7MA5S)	B	29.5/77.5
FI1501	2040002050	SAW K3561M [EUR]		
	2040002050	SAW K3561M [FRA]		
	2040002050	SAW K3561M [ESP]		
	2040002040	SAW M3565M [USA]		
	2040002050	SAW K3561M [EXP]		
	2040002050	SAW K3561M [ITR]		
	2040002050	SAW K3561M [UK]		
	2040002040	SAW M3565M [KOR]		
	2040002050	SAW K3561M [AUS]		
	2040002050	SAW K3561M [CHN]		
FI1502	2020001720	S.CER SFSKA5M50CF00-R1 (SFSCC5.5MC2-T) [EUR]	B	69.3/57.8
	2020001720	S.CER SFSKA5M50CF00-R1 (SFSCC5.5MC2-T) [FRA]		
	2020001720	S.CER SFSKA5M50CF00-R1 (SFSCC5.5MC2-T) [ESP]		
	2020001700	S.CER SFSKA4M50CF00-R1 (SFSCC4.5MC2-T) [USA]		
	2020001720	S.CER SFSKA5M50CF00-R1 (SFSCC5.5MC2-T) [EXP]		
	2020001720	S.CER SFSKA5M50CF00-R1 (SFSCC5.5MC2-T) [ITR]		
	2020001720	S.CER SFSKA5M50CF00-R1 (SFSCC5.5MC2-T) [UK]		
	2020001700	S.CER SFSKA4M50CF00-R1 (SFSCC4.5MC2-T) [KOR]		
	2020001720	S.CER SFSKA5M50CF00-R1 (SFSCC5.5MC2-T) [AUS]		
	2020001720	S.CER SFSKA5M50CF00-R1 (SFSCC5.5MC2-T) [CHN]		
FI1503	2020001730	S.CER TPSKA5M50B00-R1 (TPSCC5.5MB-TC1) [EUR]	B	73.5/78.7
	2020001730	S.CER TPSKA5M50B00-R1 (TPSCC5.5MB-TC1) [FRA]		
	2020001730	S.CER TPSKA5M50B00-R1 (TPSCC5.5MB-TC1) [ESP]		
	2020001710	S.CER TPSKA4M50B00-R1 (TPSCC4.5MO-TC1) [USA]		
	2020001730	S.CER TPSKA5M50B00-R1 (TPSCC5.5MB-TC1) [EXP]		
	2020001730	S.CER TPSKA5M50B00-R1 (TPSCC5.5MB-TC1) [ITR]		
	2020001730	S.CER TPSKA5M50B00-R1 (TPSCC5.5MB-TC1) [UK]		
	2020001710	S.CER TPSKA4M50B00-R1 (TPSCC4.5MO-TC1) [KOR]		
	2020001730	S.CER TPSKA5M50B00-R1 (TPSCC5.5MB-TC1) [AUS]		
	2020001730	S.CER TPSKA5M50B00-R1 (TPSCC5.5MB-TC1) [CHN]		
L3	6200004480	S.COI MLF1608D R82K-T	T	76.4/10.1
L4	6200002041	S.COI NLV25T-101J	T	75.6/18.9
L5	6200004780	S.COI MLF1608A 1R5K-T	T	67.4/18.6
L7	6200011320	S.COI ELJQE 56NJ [AUS] only		
L8	6200010910	S.COI LQW18AN56NG00D	T	57/16.6
L10	6200010910	S.COI LQW18AN56NG00D	T	57.3/17.9
L11	6200011780	S.COI LQW18ANR18G00D	T	56.5/20
L12	6200011680	S.COI LQW18ANR12G00D	T	53.8/19.8
L13	6200011780	S.COI LQW18ANR18G00D	T	52.8/18.5
L14	6200009590	S.COI MLG1608B 18NJ-T	T	57.3/11.4
L16	6200005721	S.COI ELJRE 33NGFA [EUR]	T	49.6/19.8
	6200005721	S.COI ELJRE 33NGFA [FRA]		
	6200005721	S.COI ELJRE 33NGFA [ESP]		
	6200005721	S.COI ELJRE 33NGFA [USA]		
	6200005721	S.COI ELJRE 33NGFA [EXP]		
	6200005721	S.COI ELJRE 33NGFA [ITR]		
	6200006991	S.COI ELJRE 56NGFA [UK]		
	6200005721	S.COI ELJRE 33NGFA [KOR]		
	6200005721	S.COI ELJRE 33NGFA [AUS]		
	6200005721	S.COI ELJRE 33NGFA [CHN]		
L18	6200005041	S.COI NLV25T-220J	T	73.4/9.5
L19	6200002041	S.COI NLV25T-101J	T	66.9/14.8
L21	6200006671	S.COI ELJRE 68NGFA	B	80.4/14.6
L22	6200002861	S.COI NLV25T-4R7J	B	79.7/20.2
L23	6200002861	S.COI NLV25T-4R7J	B	84/9.2
L24	6200011520	S.COI SLF7045T-102MR14-PF	B	8.8/69
L101	6200002041	S.COI NLV25T-101J	T	15.7/17
L102	6200002041	S.COI NLV25T-101J	T	20.4/10.9
L103	6200010800	S.COI C2520C-4R7G-A	T	24.4/7.4
L104	6200010800	S.COI C2520C-4R7G-A	T	27.9/10
L105	6200002041	S.COI NLV25T-101J	T	28.1/12.8
L106	6200002041	S.COI NLV25T-101J	B	17.5/16.3
L107	6200002041	S.COI NLV25T-101J	B	31.6/21.6
L108	6200002041	S.COI NLV25T-101J	T	25.2/20.8
L109	6200001831	S.COI NLV32T-100J	T	28.5/15.6
L110	6200003121	S.COI NLV32T-8R2J	T	21.1/15.1

M.=Mounted same (T: Mounted on the Top side, B: Mounted on the Bottom side) S.=Surface mount

[MAIN UNIT]

REF NO.	PARTS NO.	DESCRIPTION	M.	H/V LOCATION
L112	6200002041	S.COI NLV25T-101J	B	43.5/23
L113	6200002041	S.COI NLV25T-101J	T	7.2/17.6
L114	6200002041	S.COI NLV25T-101J	T	7.2/15
L116	6200003131	S.COI NLV32T-120J	T	28.5/18.6
L117	6200001831	S.COI NLV32T-100J	T	21.1/18.1
L204	6200002041	S.COI NLV25T-101J	T	18.7/32.9
L205	6200010740	S.COI C2520C-R27G-A	T	20.2/38.1
L207	6200010680	S.COI C2520C-R22G-A (0.22U)	T	21.8/41.3
L213	6200005011	S.COI NLV25T-100J	T	22.7/34.9
L215	6200010330	S.COI C2012C-R18G-A	B	27.7/38.6
L217	6200009990	S.COI C2012C-R22G-A	T	22.7/32.5
L218	6200005011	S.COI NLV25T-100J	B	25.6/43.3
L219	6200011050	S.COI C2012C-R12G-A	B	29/41.4
L220	6200010320	S.COI C2012C-R15G-A	B	34.1/37.9
L221	6200002041	S.COI NLV25T-101J	T	15.1/52.6
L222	6200002041	S.COI NLV25T-101J	T	45.6/61.4
L223	6200002041	S.COI NLV25T-101J	B	40.4/55.3
L224	6200002041	S.COI NLV25T-101J	B	27.5/55.7
L225	6200002041	S.COI NLV25T-101J	B	27.4/52
L226	6200002861	S.COI NLV25T-4R7J	T	40.3/57.6
L227	6200003711	S.COI NLV25T-2R7J	T	29.1/55.5
L228	6200002861	S.COI NLV25T-4R7J	T	44.6/54.7
L229	6200004671	S.COI NLV25T-3R9J	T	35.1/51.5
L230	6200002041	S.COI NLV25T-101J	B	40.4/52.2
L231	6200002041	S.COI NLV25T-101J	B	40.4/49.4
L232	6200002041	S.COI NLV25T-101J	B	27.1/49.1
L233	6200002041	S.COI NLV25T-101J	B	26.4/46.2
L234	6200010780	S.COI C2520C-1R0G-A	T	35.5/48.5
L235	6200010530	S.COI C2520C-R56G-A (0.56U)	B	32.9/49.5
L236	6200010950	S.COI C2520C-1R5G-A (1.5U)	T	43.4/50.4
L237	6200010450	S.COI C2520C-R82G-A (0.82U)	B	32.9/46.3
L238	6200002041	S.COI NLV25T-101J	B	43.9/45
L239	6200002041	S.COI NLV25T-101J	B	38.8/39.5
L240	6200002041	S.COI NLV25T-101J	T	29.5/42.1
L241	6200010870	S.COI C2520C-R33G-A (0.33U)	B	35.1/41.6
L242	6200005011	S.COI NLV25T-100J	T	33.5/29.9
L243	6140004601	S.COI LR-518A	T	28.4/35.2
L244	6200010960	S.COI C2520C-R47G-A (0.47U)	B	39.7/44.1
L245	6200005011	S.COI NLV25T-100J	B	41.2/28.3
L246	6200009990	S.COI C2012C-R22G-A	B	30.7/36.4
L247	6200010320	S.COI C2012C-R15G-A	B	42.1/38.7
L248	6200005011	S.COI NLV25T-100J	B	43.8/36.3
L301	6200002041	S.COI NLV25T-101J	T	36.1/27.4
L302	6200002041	S.COI NLV25T-101J	T	52.6/31.8
L303	6200002041	S.COI NLV25T-101J	T	52.3/35.4
L304	6140004591	S.COI LR-517A	T	56.4/39
L305	6200002041	S.COI NLV25T-101J	T	52.8/29.3
L306	6200002041	S.COI NLV25T-101J	T	61.7/39.3
L307	6200002041	S.COI NLV25T-101J	T	60.9/32
L308	6200002041	S.COI NLV25T-101J	T	64.9/33.1
L309	6200009070	S.COI LQW18AN18NG00D (LQW1608A18NG00)	T	49.3/24
L310	6200010650	S.COI C2520C-R12G-A (0.12U)	T	65.7/38.2
L311	6200009220	S.COI LQW18AN15NG00D (LQW1608A15NG00)	T	53.5/23.2
L312	6200010660	S.COI C2520C-R15G-A (0.15U)	T	69.6/34.3
L313	6200011730	S.COI LQW18AN10NG00D	T	61.5/25.7
L314	6200002041	S.COI NLV25T-101J	T	72.5/37.3
L315	6200002041	S.COI NLV25T-101J	T	75.8/31.9
L402	6140004610	S.COI LR-520	T	70.8/27.9
L403	6200002041	S.COI NLV25T-101J	T	81.1/19.7
L404	6130002961	S.COI #617DB-1327=P3	T	84.4/27.9
L406	6130002961	S.COI #617DB-1327=P3	T	77.6/24.2
L421	6200004590	S.COI MLF1608D R18K-T	T	86.4/21.7
L501	6200004660	S.COI MLF1608A 1R8K-T	T	93.4/35.7
L503	6200004660	S.COI MLF1608A 1R8K-T	T	83.2/31.1
L507	6200001981	S.COI NLV25T-1R0J	T	78.7/34.4
L508	6200010650	S.COI C2520C-R12G-A (0.12U)	T	86.3/34.4
L509	6200004660	S.COI MLF1608A 1R8K-T	T	93.1/38.7
L511	6200004150	S.COI MLF1608D 47NM-T	T	92.7/37.2
L512	6200009610	S.COI MLG1608B 39NJ-T	B	89.6/32.8
L601	6200004660	S.COI MLF1608A 1R8K-T	B	85.7/38.6
L603	6200004660	S.COI MLF1608A 1R8K-T	T	89.3/42.2
L604	6150005330	S.COI LS-548 PKI-4185	T	90.5/46.2
L605	6200004660	S.COI MLF1608A 1R8K-T	T	93.1/39.9
L607	6200011800	S.COI C2520C-47NG-A	B	85.4/43.5
L609	6200011800	S.COI C2520C-47NG-A	B	81.9/46.9
L610	6200004660	S.COI MLF1608A 1R8K-T	B	78.1/44.8
L611	6200004660	S.COI MLF1608A 1R8K-T	T	68/46.3
L612	6150005330	S.COI LS-548 PKI-4185	T	72.2/42.4
L701	6150005350	S.COI LS-550 PKI-4187	T	62.9/48.6
L702	6150005340	S.COI LS-549 PKI-4186	T	54.8/45.4
L703	6150005350	S.COI LS-550 PKI-4187	T	55.3/59.5
L704	6200004940	S.COI MLF1608D R27K-T	T	62.3/59.6
L705	6200009920	S.COI C2012C-R10G-A	T	61.8/41.7
L801	6140002810	S.COI LR-317	T	68.6/61.3
L802	6200005190	S.COI MLF1608D R56K-T	T	89/58.4
L803	6140002810	S.COI LR-317	T	79.6/60.1
L804	6200005011	S.COI NLV25T-100J	T	57.5/69.1
L805	6200009871	S.COI NLV25T-120J	T	57.6/71.9
L806	6200004741	S.COI NLV25T-1R2J	T	63.1/71.2
L807	6200004741	S.COI NLV25T-1R2J	T	63.2/66.7
L808	6200004100	S.COI MLF1608D 68NM-T	T	86.1/61.6
L901	6200003520	S.COI ELJFB 102K-F	B	37.6/72.4
L904	6150005360	S.COI LS-551 PKI-4188-1	T	51.6/70.9
L905	6200003520	S.COI ELJFB 102K-F	B	40.2/59.9
L906	6200003520	S.COI ELJFB 102K-F	B	33.6/62.4
L908	6200003520	S.COI ELJFB 102K-F	B	31.5/69.7

[MAIN UNIT]

REF NO.	PARTS NO.	DESCRIPTION	M.	H/V LOCATION
L1003	6200003520	S.COI ELJFB 102K-F	B	12.9/75.3
L1102	6200002041	S.COI NLV25T-101J	T	7.1/89.7
L1301	6200002041	S.COI NLV25T-101J	T	8.3/55.8
L1302	6200002041	S.COI NLV25T-101J	T	11.8/58.5
L1303	6200002041	S.COI NLV25T-101J	T	4.8/55.8
L1401	6200002041	S.COI NLV25T-101J	B	43.3/79.6
L1402	6200004790	S.COI MLF1608D R47K-T	B	44.1/70.4
L1403	6200002041	S.COI NLV25T-101J	B	43/77.1
L1404	6200003711	S.COI NLV25T-2R7J	B	18.2/80.4
L1405	6200002041	S.COI NLV25T-101J	B	17.7/85
L1491	6200010870	S.COI C2520C-R33G-A (0.33U) [EUR]	B	84.9/30.7
	6200010870	S.COI C2520C-R33G-A (0.33U) [FRA]		
	6200010870	S.COI C2520C-R33G-A (0.33U) [ESP]		
	6200010740	S.COI C2520C-R27G-A [USA]		
	6200010870	S.COI C2520C-R33G-A (0.33U) [EXP]		
	6200010870	S.COI C2520C-R33G-A (0.33U) [ITR]		
	6200010870	S.COI C2520C-R33G-A (0.33U) [UK]		
	6200010740	S.COI C2520C-R27G-A [KOR]		
	6200010870	S.COI C2520C-R33G-A (0.33U) [AUS]		
	6200010870	S.COI C2520C-R33G-A (0.33U) [CHN]		
L1492	6200010870	S.COI C2520C-R33G-A (0.33U) [EUR]	B	80.6/33.1
	6200010870	S.COI C2520C-R33G-A (0.33U) [FRA]		
	6200010870	S.COI C2520C-R33G-A (0.33U) [ESP]		
	6200010740	S.COI C2520C-R27G-A [USA]		
	6200010870	S.COI C2520C-R33G-A (0.33U) [EXP]		
	6200010870	S.COI C2520C-R33G-A (0.33U) [ITR]		
	6200010870	S.COI C2520C-R33G-A (0.33U) [UK]		
	6200010740	S.COI C2520C-R27G-A [KOR]		
	6200010870	S.COI C2520C-R33G-A (0.33U) [AUS]		
	6200010870	S.COI C2520C-R33G-A (0.33U) [CHN]		
L1501	6200005011	S.COI NLV25T-100J	B	91.1/27.1
L1502	6200012170	S.COI MLG1608SR18J-T	B	79.4/38.2
L1503	6200012170	S.COI MLG1608SR18J-T	B	82/37.5
L1504	6200005011	S.COI NLV25T-100J	B	75.6/43.1
L1505	6200005190	S.COI MLF1608D R56K-T	B	80.7/51.7
L1506	6150005080	S.COI LS-535 (4KMH) [EUR]	T	68.7/55.4
	6150005080	S.COI LS-535 (4KMH) [FRA]		
	6150005080	S.COI LS-535 (4KMH) [ESP]		
	6150005070	S.COI LS-534 (4KMH) [USA]		
	6150005080	S.COI LS-535 (4KMH) [EXP]		
	6150005080	S.COI LS-535 (4KMH) [ITR]		
	6150005080	S.COI LS-535 (4KMH) [UK]		
	6150005070	S.COI LS-534 (4KMH) [KOR]		
	6150005080	S.COI LS-535 (4KMH) [AUS]		
	6150005080	S.COI LS-535 (4KMH) [CHN]		
L1507	6200005031	S.COI NLV25T-180J	B	71.7/62.2
L1508	6200005021	S.COI NLV25T-150J	B	77.3/79.5
L1951	6180003610	S.COI 7E10L-101M 100U	B	34.6/110.9
L1952	6180003610	S.COI 7E10L-101M 100U	B	54.7/113.3
L1953	6180003610	S.COI 7E10L-101M 100U	B	14/111.9
L1954	6180003610	S.COI 7E10L-101M 100U	B	24.4/119.8
L2001	6200005011	S.COI NLV25T-100J	B	72.5/16.4
L2002	6200002041	S.COI NLV25T-101J	B	84.5/3.8
L2003	6200002041	S.COI NLV25T-101J	B	81.1/4.3
L2004	6200002041	S.COI NLV25T-101J	B	76.3/20.4
L2006	6200002041	S.COI NLV25T-101J	B	64.2/12.8
L2007	6200002041	S.COI NLV25T-101J	B	70.9/3.8
L2008	6200002041	S.COI NLV25T-101J	B	67.9/6.1
L2009	6200005011	S.COI NLV25T-100J	B	70.8/10.6
L2010	6200002041	S.COI NLV25T-101J	B	60.7/13.7
L2011	6200011300	S.COI EXCML16A270U	T	86.6/9.1
L2012	6200011300	S.COI EXCML16A270U	B	84.7/21.9
L2013	6200002041	S.COI NLV25T-101J	B	71.8/19.4
L2015	6200002041	S.COI NLV25T-101J	B	52.5/10.4
L2016	6200002041	S.COI NLV25T-101J	B	59.2/11.2
L2017	6200002041	S.COI NLV25T-101J	B	57/14
L2018	6200002041	S.COI NLV25T-101J	B	19.7/129.4
L2019	6200002041	S.COI NLV25T-101J	T	22.2/126.9
L2020	6200002041	S.COI NLV25T-101J	B	27.9/131.3
L2021	6200005011	S.COI NLV25T-100J	B	27.9/126.5
L2022	6200002041	S.COI NLV25T-101J	B	22.6/127.6
L2023	6200002041	S.COI NLV25T-101J	B	23.2/131.3
L2024	6200002041	S.COI NLV25T-101J	T	12.7/128.2
L2025	6200002041	S.COI NLV25T-101J	B	87.5/6.2
L2026	6200002041	S.COI NLV25T-101J	B	77.6/5
L2027	6200002041	S.COI NLV25T-101J	B	76.5/12.2
L2028	6200002041	S.COI NLV25T-101J	B	67.4/10.8
L2029	6200002041	S.COI NLV25T-101J	B	64/10.3
L2030	6200002041	S.COI NLV25T-101J	B	67.5/3.6
L2031	6200002041	S.COI NLV25T-101J	B	76.5/14.7
L2032	6200002041	S.COI NLV25T-101J	B	66.1/15.3
L2033	6200011300	S.COI EXCML16A270U	B	69.6/14.5
L2034	6200009300	S.COI ELJPA 100KF 10U	B	67.8/19.3
L2035	6200002041	S.COI NLV25T-101J	B	59.8/18.4
L2036	6200002041	S.COI NLV25T-101J	B	64.1/3.8
L2037	6200002041	S.COI NLV25T-101J	B	88.3/3.7
L2041	6180003610	S.COI 7E10L-101M 100U	B	62.6/86.9
L2042	6200002861	S.COI NLV25T-4R7J	B	62.9/79.3
L2053	6200002041	S.COI NLV25T-101J	B	28.7/90.9
L2151	6200002041	S.COI NLV25T-101J	B	36.9/121
L2152	6200002041	S.COI NLV25T-101J	B	52.3/14.7
L2201	6200005011	S.COI NLV25T-100J	T	27.3/125.8
L2202	6200005011	S.COI NLV25T-100J		

[MAIN UNIT]

REF NO.	PARTS NO.	DESCRIPTION	M.	H/V LOCATION
L2264	6200002041	S.COI NLV25T-101J	T	62.3/96.9
L2265	6200002041	S.COI NLV25T-101J	T	62.4/94.3
L2266	6200002041	S.COI NLV25T-101J	T	62.4/91.5
L2267	6200002041	S.COI NLV25T-101J	T	66/89.6
L2268	6200002041	S.COI NLV25T-101J	T	62.4/87.1
L2272	6200002041	S.COI NLV25T-101J	T	71.1/90.2
L2402	6200002041	S.COI NLV25T-101J	B	89.4/98
L2403	6200002041	S.COI NLV25T-101J	B	89.2/84
L2404	6200002041	S.COI NLV25T-101J	T	81.6/96.8
L2405	6200002041	S.COI NLV25T-101J	B	89.3/95.5
L2406	6200002041	S.COI NLV25T-101J	T	84.8/93.7
L2408	6200011300	S.COI EXCML16A270U	T	82.1/92.3
L2409	6200002041	S.COI NLV25T-101J	B	89.3/88.5
L2411	6200011300	S.COI EXCML16A270U	T	85.1/89.7
L2601	6200009330	S.COI SFL12555T-681MR43-PF	T	87.5/119.6
L2605	6200009330	S.COI SFL12555T-681MR43-PF	T	71/119.6
R1	7030011400	S.RES ERJ2GEJ 5R6 X (5.6)	T	79.7/17
R2	7030009270	S.RES ERJ2GEJ 821 X (820)	T	81.3/17
R3	7030009270	S.RES ERJ2GEJ 821 X (820)	T	79.7/17.9
R5	7030010090	S.RES ERJ2GEJ 180 X (18)	T	74.2/16.7
R6	7030008280	S.RES ERJ2GEJ 271 X (270)	T	74.8/15.8
R7	7030008280	S.RES ERJ2GEJ 271 X (270)	T	73.2/15.8
R8	7030009200	S.RES ERJ2GEJ 390 X (39)	T	73/18.5
R9	7030003400	S.RES ERJ3GEVJ 471 V (470)	T	69.9/13.3
R10	7030005120	S.RES ERJ2GEJ 102 X (1K)	T	72.8/14.9
R11	7030005300	S.RES ERJ2GEJ 150 X (15)	T	62.1/15.9
R12	7030010040	S.RES ERJ2GEJ-JPW	T	62.9/13.8
R13	7030005090	S.RES ERJ2GEJ 104 X (100K)	T	66.8/20.6
R15	7030005090	S.RES ERJ2GEJ 104 X (100K)	T	70.4/10.4
R16	7030003860	S.RES ERJ3GE JPW V	T	62.4/12.3
R17	7030005090	S.RES ERJ2GEJ 104 X (100K)	T	76.4/15.8
R18	7030007270	S.RES ERJ2GEJ 151 X (150)	T	44.2/17.2
R19	7030003860	S.RES ERJ3GE JPW V	T	50.4/14.6
R20	7030009530	S.RES ERJ2GEJ 270 X (27)	T	69.5/19.7
R21	7030009530	S.RES ERJ2GEJ 270 X (27)	T	65.4/22.8
R22	7030010040	S.RES ERJ2GEJ-JPW	T	78.1/13.8
R23	7030007290	S.RES ERJ2GEJ 222 X (2.2K)	T	79.8/13.8
R24	7030005010	S.RES ERJ2GEJ 681 X (680)	T	78.1/12.9
R25	7030005120	S.RES ERJ2GEJ 102 X (1K)	B	79.2/18.5
R27	7030005120	S.RES ERJ2GEJ 102 X (1K)	B	81.3/8.5
R29	7030004980	S.RES ERJ2GEJ 101 X (100)	T	73.1/11.3
R30	7030009160	S.RES ERJ2GEJ 181 X (180)	T	46.4/15.4
R31	7030007270	S.RES ERJ2GEJ 151 X (150)	T	42.6/17.2
R32	7030009200	S.RES ERJ2GEJ 390 X (39)	T	44.1/18.2
R35	7030003860	S.RES ERJ3GE JPW V	[EUR] T	59.9/17.8
	7030003860	S.RES ERJ3GE JPW V	[FRA] T	
	7030003860	S.RES ERJ3GE JPW V	[ESP] T	
	7030003860	S.RES ERJ3GE JPW V	[USA] T	
	7030003860	S.RES ERJ3GE JPW V	[EXP] T	
	7030003860	S.RES ERJ3GE JPW V	[ITR] T	
	7030003860	S.RES ERJ3GE JPW V	[UK] T	
	7030003860	S.RES ERJ3GE JPW V	[KOR] T	
	7030003860	S.RES ERJ3GE JPW V	[CHN] T	
R101	7030005050	S.RES ERJ2GEJ 103 X (10K)	T	13.2/16
R102	7030005120	S.RES ERJ2GEJ 102 X (1K)	T	11.9/14.6
R103	7030005050	S.RES ERJ2GEJ 103 X (10K)	T	10.3/14.6
R104	7030005090	S.RES ERJ2GEJ 104 X (100K)	T	15.7/13.4
R105	7030005580	S.RES ERJ2GEJ 560 X (56)	T	15.7/22.3
R106	7030005000	S.RES ERJ2GEJ 471 X (470)	T	13.2/20.5
R107	7030005000	S.RES ERJ2GEJ 471 X (470)	T	10.8/22.1
R108	7030005000	S.RES ERJ2GEJ 471 X (470)	T	10.8/23
R111	7030005000	S.RES ERJ2GEJ 471 X (470)	T	10.8/21.2
R112	7030005090	S.RES ERJ2GEJ 104 X (100K)	T	25.6/12.5
R113	7030005090	S.RES ERJ2GEJ 104 X (100K)	T	26.8/5.7
R114	7030009280	S.RES ERJ2GEJ 391 X	B	33.1/23.4
R115	7030009280	S.RES ERJ2GEJ 391 X	B	34.1/22.2
R116	7030009280	S.RES ERJ2GEJ 391 X	T	22.3/21.3
R117	7030009280	S.RES ERJ2GEJ 391 X	T	20.7/21.3
R118	7030009280	S.RES ERJ2GEJ 391 X	B	40.9/23.2
R119	7030009280	S.RES ERJ2GEJ 391 X	B	40.9/22.3
R120	7030005090	S.RES ERJ2GEJ 104 X (100K)	B	50.3/23.5
R121	7030005090	S.RES ERJ2GEJ 104 X (100K)	T	44/22.2
R122	7030009280	S.RES ERJ2GEJ 391 X	T	7.8/20.3
R123	7030009280	S.RES ERJ2GEJ 391 X	T	7.8/19.4
R125	7030009280	S.RES ERJ2GEJ 391 X	T	35.5/20.2
R126	7030009280	S.RES ERJ2GEJ 391 X	T	27/4.8
R127	7030009280	S.RES ERJ2GEJ 391 X	T	25.4/4.8
R128	7030009280	S.RES ERJ2GEJ 391 X	T	35.5/19.3
R129	7030003360	S.RES ERJ3GEVJ 221 V (220)	T	61.2/28.2
R202	7030005090	S.RES ERJ2GEJ 104 X (100K)	T	18.1/31.2
R203	7030005090	S.RES ERJ2GEJ 104 X (100K)	T	42.9/59.9
R204	7030005090	S.RES ERJ2GEJ 104 X (100K)	B	42.9/54.3
R205	7030009280	S.RES ERJ2GEJ 391 X	T	19.4/54.2
R206	7030005090	S.RES ERJ2GEJ 104 X (100K)	B	42.9/51.4
R207	7030005090	S.RES ERJ2GEJ 104 X (100K)	B	42.9/50.5
R208	7030005090	S.RES ERJ2GEJ 104 X (100K)	B	46.4/45
R216	7030005090	S.RES ERJ2GEJ 104 X (100K)	B	44.2/43.3
R217	7030005050	S.RES ERJ2GEJ 103 X (10K)	T	18.1/30.3
R218	7030004970	S.RES ERJ2GEJ 470 X (47)	T	21.9/29.9
R225	7030005050	S.RES ERJ2GEJ 103 X (10K)	T	19.1/29.1
R226	7030009280	S.RES ERJ2GEJ 391 X	T	17.6/54.2
R227	7030005120	S.RES ERJ2GEJ 102 X (1K)	T	30.9/30.9
R228	7030009140	S.RES ERJ2GEJ 272 X (2.7K)	T	30.9/29.1
R301	7030009280	S.RES ERJ2GEJ 391 X	T	44.5/28.8
R302	7030009280	S.RES ERJ2GEJ 391 X	T	38.6/27.8
R303	7030004970	S.RES ERJ2GEJ 470 X (47)	T	52.5/38.9

[MAIN UNIT]

REF NO.	PARTS NO.	DESCRIPTION	M.	H/V LOCATION
R304	7030004980	S.RES ERJ2GEJ 101 X (100)	T	55.1/35.6
R305	7030005120	S.RES ERJ2GEJ 102 X (1K)	T	59.9/33.8
R306	7030008280	S.RES ERJ2GEJ 271 X (270)	T	55.3/28.7
R307	7030004980	S.RES ERJ2GEJ 101 X (100)	T	56.7/35.6
R308	7030007290	S.RES ERJ2GEJ 222 X (2.2K)	T	59.2/30.1
R309	7030008280	S.RES ERJ2GEJ 271 X (270)	T	58.5/29.1
R310	7030005090	S.RES ERJ2GEJ 104 X (100K)	T	50.1/31.7
R311	7030009280	S.RES ERJ2GEJ 391 X	T	65.3/31.3
R312	7030009280	S.RES ERJ2GEJ 391 X	T	63.7/31.3
R314	7030009280	S.RES ERJ2GEJ 391 X	T	73.3/32.5
R315	7030009280	S.RES ERJ2GEJ 391 X	T	74.8/33.8
R401	7030010040	S.RES ERJ2GEJ-JPW	T	75/29.5
R402	7030010040	S.RES ERJ2GEJ-JPW	T	75/27.7
R403	7030004980	S.RES ERJ2GEJ 101 X (100)	T	76.7/29.6
R404	7030010040	S.RES ERJ2GEJ-JPW	T	71.9/23.1
R405	7030004980	S.RES ERJ2GEJ 101 X (100)	T	86.8/23.8
R406	7030005580	S.RES ERJ2GEJ 560 X (56)	T	73.1/30.6
R407	7030005580	S.RES ERJ2GEJ 560 X (56)	T	71.9/24.9
R408	7030010040	S.RES ERJ2GEJ-JPW	T	83.3/19.2
R411	7030007260	S.RES ERJ2GEJ 330 X (33)	T	80/29.5
R412	7030007260	S.RES ERJ2GEJ 330 X (33)	T	80/26.8
R414	7030004980	S.RES ERJ2GEJ 101 X (100)	T	78.3/29.6
R416	7030010090	S.RES ERJ2GEJ 180 X (18)	T	88.3/24.4
R417	7030008280	S.RES ERJ2GEJ 271 X (270)	T	89.2/25.3
R418	7030008280	S.RES ERJ2GEJ 271 X (270)	T	88/22.8
R421	7030010090	S.RES ERJ2GEJ 180 X (18)	B	88.5/20.2
R422	7030008280	S.RES ERJ2GEJ 271 X (270)	B	90.1/20.2
R423	7030008280	S.RES ERJ2GEJ 271 X (270)	B	90.1/19.3
R424	7030005530	S.RES ERJ2GEJ 100 X (10)	T	88.5/21.6
R501	7030005120	S.RES ERJ2GEJ 102 X (1K)	T	91.3/35.6
R502	7030005120	S.RES ERJ2GEJ 102 X (1K)	T	92.9/34.4
R509	7030005580	S.RES ERJ2GEJ 560 X (56)	T	83.4/33.1
R510	7030010040	S.RES ERJ2GEJ-JPW	T	83.4/34.1
R512	7030004980	S.RES ERJ2GEJ 101 X (100)	T	81.7/34.1
R517	7030010040	S.RES ERJ2GEJ-JPW	B	80/31
R518	7030007290	S.RES ERJ2GEJ 222 X (2.2K)	T	79.5/37
R519	7030007290	S.RES ERJ2GEJ 222 X (2.2K)	T	79.5/38.8
R520	7030005120	S.RES ERJ2GEJ 102 X (1K)	T	89.1/39.2
R521	7030005000	S.RES ERJ2GEJ 471 X (470)	T	84.2/40.4
R523	7030005120	S.RES ERJ2GEJ 102 X (1K)	T	91.3/34.7
R524	7030005120	S.RES ERJ2GEJ 102 X (1K)	B	86.9/37
R601	7030005000	S.RES ERJ2GEJ 471 X (470)	B	88.5/40
R602	7030005000	S.RES ERJ2GEJ 471 X (470)	T	91/39.6
R603	7030005000	S.RES ERJ2GEJ 471 X (470)	T	89.1/41
R604	7030005000	S.RES ERJ2GEJ 471 X (470)	B	78.6/45.9
R605	7030010040	S.RES ERJ2GEJ-JPW	T	68.2/45.2
R606	7030005090	S.RES ERJ2GEJ 104 X (100K)	T	67.1/47.4
R607	7030005120	S.RES ERJ2GEJ 102 X (1K)	T	66.6/45.2
R701	7030005220	S.RES ERJ2GEJ 223 X (22K)	T	61.1/53
R702	7030005120	S.RES ERJ2GEJ 102 X (1K)	T	64.2/43.9
R703	7030004970	S.RES ERJ2GEJ 470 X (47)	T	50.8/44.1
R705	7030004990	S.RES ERJ2GEJ 221 X (220)	T	59/51.5
R706	7030009270	S.RES ERJ2GEJ 821 X (820)	T	64.5/55.9
R707	7030004980	S.RES ERJ2GEJ 101 X (100)	T	59.5/57
R708	7030007290	S.RES ERJ2GEJ 222 X (2.2K)	T	63.9/58.6
R709	7030005210	S.RES ERJ2GEJ 822 X (8.2K)	T	59.5/55.1
R710	7030005120	S.RES ERJ2GEJ 102 X (1K)	T	59.8/62.5
R711	7030009140	S.RES ERJ2GEJ 272 X (2.7K)	T	50.5/51.4
R712	7030005120	S.RES ERJ2GEJ 102 X (1K)	T	51.2/50.5
R713	7030005050	S.RES ERJ2GEJ 103 X (10K)	T	57.1/51.5
R715	7030004970	S.RES ERJ2GEJ 470 X (47)	T	52.1/54.1
R716	7030005710	S.RES ERJ2GEJ 121 X (120)	T	51.3/57.5
R717	7030007300	S.RES ERJ2GEJ 332 X (3.3K)	T	52.1/51.4
R718	7510001461	S.THE NTCG16 3NH 471JT	T	63.3/54
R801	7030008280	S.RES ERJ2GEJ 271 X (270)	T	86.8/55.2
R802	7030005120	S.RES ERJ2GEJ 102 X (1K)	T	65.3/60.9
R803	7030005120	S.RES ERJ2GEJ 102 X (1K)	T	71.9/64.9
R804	7030005530	S.RES ERJ2GEJ 100 X (10)	T	91.1/57.1
R805	7030010090	S.RES ERJ2GEJ 180 X (18)	T	84.7/54.3
R806	7030008280	S.RES ERJ2GEJ 271 X (270)	T	85.2/55.2
R807	7030005120	S.RES ERJ2GEJ 102 X (1K)	T	62.8/64.6
R808	7030004970	S.RES ERJ2GEJ 470 X (47)	T	62.3/69.4
R809	7030008280	S.RES ERJ2GEJ 271 X (270)	T	82.8/60.6
R810	7030010090	S.RES ERJ2GEJ 180 X (18)	T	84.4/60.6
R811	7030008280	S.RES ERJ2GEJ 271 X (270)	T	82.8/59.7
R904	7030003860	S.RES ERJ3GE JPW V	T	36.5/68.1
R905	7030004980	S.RES ERJ2GEJ 101 X (100)	T	39.2/64.6
R906	7030007290	S.RES ERJ2GEJ 222 X (2.2K)	T	39.2/66.5
R908	7030005000	S.RES ERJ2GEJ 471 X (470)	T	35.6/61.9
R909	7030008410	S.RES ERJ2GEJ 392 X (3.9K)	T	34.2/68.4
R912	7030005210	S.RES ERJ2GEJ 822 X (8.2K)	T	34.2/66.6
R913	7030007300	S.RES ERJ2GEJ 332 X (3.3K)	T	40.5/75
R914	7030009290	S.RES ERJ2GEJ 562 X (5.6K)	T	35.6/75.4
R915	7030007290	S.RES ERJ2GEJ 222 X (2.2K)	T	36.6/70.9
R916	7030005050	S.RES ERJ2GEJ 103 X (10K)	T	37.2/75.4
R917	7030004970	S.RES ERJ2GEJ 470 X (47)	T	34.2/69.3
R918	7030007290	S.RES ERJ2GEJ 222 X (2.2K)	B	31.4/72.1
R919	7030004980	S.RES ERJ2GEJ 101 X (100)	T	31.5/72.1
R1009	7030009290	S.RES ERJ2GEJ 562 X (5.6K)	T	25.8/77.5
R1018	7030007290	S.RES ERJ2GEJ 222 X (2.2K)	T	20.3/75
R1019	7030005050	S.RES ERJ2GEJ 103 X (10K		

[MAIN UNIT]

REF NO.	PARTS NO.	DESCRIPTION	M.	H/V LOCATION
R1202	7030005240	S.RES ERJ2GEJ 473 X (47K)	T	24/78.5
R1203	7030005240	S.RES ERJ2GEJ 473 X (47K)	T	25.6/78.5
R1204	7030005240	S.RES ERJ2GEJ 473 X (47K)	T	20.2/79.2
R1205	7030005000	S.RES ERJ2GEJ 471 X (470)	T	20.2/78.3
R1206	7030005090	S.RES ERJ2GEJ 104 X (100K)	T	21.8/79.2
R1207	7030005240	S.RES ERJ2GEJ 473 X (47K)	T	17.9/83.6
R1208	7030004980	S.RES ERJ2GEJ 101 X (100)	T	9.4/79.8
R1209	7030004980	S.RES ERJ2GEJ 101 X (100)	T	16.4/79.8
R1211	7030005120	S.RES ERJ2GEJ 102 X (1K)	T	12.7/79.4
R1212	7030005120	S.RES ERJ2GEJ 102 X (1K)	T	11.1/78.5
R1213	7030005120	S.RES ERJ2GEJ 102 X (1K)	T	11.1/79.4
R1215	7030007350	S.RES ERJ2GEJ 393 X (39K)	T	8.1/81.3
R1216	7030007290	S.RES ERJ2GEJ 222 X (2.2K)	T	9.5/83.4
R1217	7030007290	S.RES ERJ2GEJ 222 X (2.2K)	T	8/82.8
R1218	7030005050	S.RES ERJ2GEJ 103 X (10K)	T	7.5/78.5
R1219	7030005050	S.RES ERJ2GEJ 103 X (10K)	T	7.5/79.7
R1301	7030010040	S.RES ERJ2GEJ-JPW	T	15.2/74.8
R1302	7030005120	S.RES ERJ2GEJ 102 X (1K)	T	15.2/72.7
R1303	7030005120	S.RES ERJ2GEJ 102 X (1K)	T	12.7/74
R1304	7030005120	S.RES ERJ2GEJ 102 X (1K)	T	14.9/68.3
R1305	7030005120	S.RES ERJ2GEJ 102 X (1K)	T	16.2/63.8
R1306	7030005120	S.RES ERJ2GEJ 102 X (1K)	T	10.9/56.8
R1308	7030007300	S.RES ERJ2GEJ 332 X (3.3K)	T	12.9/67.3
R1309	7030005120	S.RES ERJ2GEJ 102 X (1K)	T	11.3/66.4
R1310	7510001451	S.THE NTCG16 4BH 472JT	T	12.2/68.4
R1401	7030005120	S.RES ERJ2GEJ 102 X (1K)	B	45.3/72.3
R1402	7030008010	S.RES ERJ2GEJ 123 X (12K)	B	43.6/72.3
R1403	7030007290	S.RES ERJ2GEJ 222 X (2.2K)	B	44.5/73.4
R1404	7030007280	S.RES ERJ2GEJ 331 X (330)	B	44.5/75.2
R1405	7030004970	S.RES ERJ2GEJ 470 X (47)	B	42/71.5
R1406	7030005290	S.RES ERJ2GEJ 682 X (6.8K)	B	38.7/79.9
R1407	7030005120	S.RES ERJ2GEJ 102 X (1K)	B	38.7/79
R1408	7030007280	S.RES ERJ2GEJ 331 X (330)	B	38.7/80.8
R1409	7030004970	S.RES ERJ2GEJ 470 X (47)	B	34.6/80
R1414	7030007340	S.RES ERJ2GEJ 153 X (15K)	B	20.2/76.4
R1416	7030008410	S.RES ERJ2GEJ 392 X (3.9K)	B	19.4/83
R1420	7030004990	S.RES ERJ2GEJ 221 X (220)	B	25/76.8
R1421	7030007270	S.RES ERJ2GEJ 151 X (150)	B	23.2/75.9
R1422	7030004990	S.RES ERJ2GEJ 221 X (220)	B	23.2/76.8
R1501	7030010040	S.RES ERJ2GEJ-JPW	B	72.4/38.2
R1502	7030005100	S.RES ERJ2GEJ 154 X (150K)	B	86.4/55.3
R1503	7030005100	S.RES ERJ2GEJ 154 X (150K)	B	85.7/54.1
R1504	7030004970	S.RES ERJ2GEJ 470 X (47)	B	72.4/40.3
R1505	7030007290	S.RES ERJ2GEJ 222 X (2.2K)	B	71.8/53.9
R1506	7030007350	S.RES ERJ2GEJ 393 X (39K)	B	85.7/52.3
R1507	7030007350	S.RES ERJ2GEJ 393 X (39K)	B	85.7/53.2
R1508	7030005220	S.RES ERJ2GEJ 223 X (22K)	B	74.2/61.6
R1509	7030006610	S.RES ERJ2GEJ 394 X (390K)	B	85.9/59
R1510	7030005050	S.RES ERJ2GEJ 103 X (10K)	[USA] [KOR] B	76.6/61.9
R1511	7030005590	S.RES ERJ2GEJ 680 X (68)	B	85.8/60.8
R1512	7030005120	S.RES ERJ2GEJ 102 X (1K)	B	71.5/73.7
R1513	7030007280	S.RES ERJ2GEJ 331 X (330)	B	73.1/73.7
R1514	7030007290	S.RES ERJ2GEJ 222 X (2.2K)	B	73.4/53
R1515	7030007290	S.RES ERJ2GEJ 222 X (2.2K)	B	71.8/53
R1516	7030004970	S.RES ERJ2GEJ 470 X (47)	B	82.5/35.7
R1521	7030005090	S.RES ERJ2GEJ 104 X (100K)	B	86.5/49.3
R1522	7030005240	S.RES ERJ2GEJ 473 X (47K)	B	84.8/45.8
R1523	7030005120	S.RES ERJ2GEJ 102 X (1K)	B	77.3/39.5
R1524	7030005120	S.RES ERJ2GEJ 102 X (1K)	B	81.9/40.3
R1525	7030007300	S.RES ERJ2GEJ 332 X (3.3K)	B	81.9/42.2
R1526	7030005120	S.RES ERJ2GEJ 102 X (1K)	B	83.5/40.5
R1527	7030005000	S.RES ERJ2GEJ 471 X (470)	B	78.5/51.8
R1528	7030005000	S.RES ERJ2GEJ 471 X (470)	B	73/51.8
R1602	7030005120	S.RES ERJ2GEJ 102 X (1K)	T	6.3/54
R1603	7030010040	S.RES ERJ2GEJ-JPW	T	13/49.6
R1604	7030007290	S.RES ERJ2GEJ 222 X (2.2K)	T	13/50.5
R1605	7030005090	S.RES ERJ2GEJ 104 X (100K)	T	8.8/46.9
R1606	7030005070	S.RES ERJ2GEJ 683 X (68K)	T	6.1/46.6
R1607	7030005070	S.RES ERJ2GEJ 683 X (68K)	T	5.1/42.1
R1608	7030005090	S.RES ERJ2GEJ 104 X (100K)	T	10.4/47.8
R1609	7030007320	S.RES ERJ2GEJ 225 X (2.2M)	T	10.4/46
R1610	7030005060	S.RES ERJ2GEJ 333 X (33K)	T	4.5/43.5
R1611	7030005230	S.RES ERJ2GEJ 334 X (330K)	T	8.8/47.8
R1612	7030005060	S.RES ERJ2GEJ 333 X (33K)	T	3.4/42.3
R1613	7030003860	S.RES ERJ3GE JPW V	T	6.7/48.7
R1614	7030007310	S.RES ERJ2GEJ 155 X (1.5M)	T	6.1/45.7
R1615	7030005040	S.RES ERJ2GEJ 472 X (4.7K)	T	4.2/35.4
R1616	7030005090	S.RES ERJ2GEJ 104 X (100K)	T	6.7/35.4
R1617	7030005720	S.RES ERJ2GEJ 563 X (56K)	T	3.4/38.2
R1618	7310005540	S.TRI TMC3ADC14X (10K)	T	3.5/46.3
R1619	7030005080	S.RES ERJ2GEJ 823 X (82K)	[EUR] [FRA] [ESP] [USA] [EXP] [ITR] [UK] [KOR] [AUS] [CHN]	2.6/43.3
R1620	7030008290	S.RES ERJ2GEJ 183 X (18K)	T	3.4/37.3
R1621	7030005160	S.RES ERJ2GEJ 105 X (1M)	T	6.7/37.2
R1622	7030010040	S.RES ERJ2GEJ-JPW	T	5/37.3
R1623	7030005000	S.RES ERJ2GEJ 471 X (470)	T	12/46.8
R1624	7030007250	S.RES ERJ2GEJ 220 X (22)	T	14.9/38.3
R1625	7030004990	S.RES ERJ2GEJ 221 X (220)	T	13.6/32.6
R1626	7030005050	S.RES ERJ2GEJ 103 X (10K)	T	10.3/34.5

[MAIN UNIT]

REF NO.	PARTS NO.	DESCRIPTION	M.	H/V LOCATION
R1627	7030007320	S.RES ERJ2GEJ 225 X (2.2M)	T	10.3/35.4
R1628	7030005120	S.RES ERJ2GEJ 102 X (1K)	T	4.9/30.8
R1629	7030005050	S.RES ERJ2GEJ 103 X (10K)	T	4.9/29.9
R1630	7030004980	S.RES ERJ2GEJ 101 X (100)	T	8.3/45.7
R1631	7030005090	S.RES ERJ2GEJ 104 X (100K)	T	9.8/37.2
R1634	7030005040	S.RES ERJ2GEJ 472 X (4.7K)	T	10.3/33.6
R1636	7030007320	S.RES ERJ2GEJ 225 X (2.2M)	T	13/31.7
R1637	7030007320	S.RES ERJ2GEJ 225 X (2.2M)	T	12/45.9
R1638	7030008280	S.RES ERJ2GEJ 271 X (270)	T	10.9/48.8
R1639	7030005120	S.RES ERJ2GEJ 102 X (1K)	T	14.6/50.5
R1640	7030005090	S.RES ERJ2GEJ 104 X (100K)	T	10.9/31.6
R1641	7030007320	S.RES ERJ2GEJ 225 X (2.2M)	T	13/30.7
R1642	7030005120	S.RES ERJ2GEJ 102 X (1K)	T	22.9/55.1
R1701	7030009320	S.RES ERJ2GEJ 4R7 X (4.7)	T	48/45.3
R1702	7030007280	S.RES ERJ2GEJ 331 X (330)	B	52.1/44.7
R1703	7030007280	S.RES ERJ2GEJ 331 X (330)	B	53.7/43.8
R1704	7030007280	S.RES ERJ2GEJ 331 X (330)	B	53.7/44.7
R1705	7030009320	S.RES ERJ2GEJ 4R7 X (4.7)	T	48/46.2
R1706	7030007280	S.RES ERJ2GEJ 331 X (330)	B	53.6/64.2
R1707	7030007280	S.RES ERJ2GEJ 331 X (330)	B	55.6/64.8
R1708	7030007280	S.RES ERJ2GEJ 331 X (330)	B	55.6/65.7
R1901	7030005090	S.RES ERJ2GEJ 104 X (100K)	B	20/13.9
R1902	7030011290	S.RES ERJ12YJ1R8U (1.8)	B	12.4/45.8
R1952	7030009980	S.RES ERJ12RSJR15U	B	42.6/102.3
R1953	7030009980	S.RES ERJ12RSJR15U	B	42.6/98.6
R1954	7030005170	S.RES ERJ2GEJ 474 X (470K)	B	42.7/111.3
R1955	7030005511	S.RES ERA3YED 303V (30K)	B	44.8/107.3
R1956	7030005110	S.RES ERJ2GEJ 224 X (220K)	B	33.7/105.1
R1957	7030007350	S.RES ERJ2GEJ 393 X (39K)	B	35.3/104.2
R1958	7030005720	S.RES ERJ2GEJ 563 X (56K)	B	35.3/103.3
R1981	7030008240	S.RES ERJ12Y0R00U	B	83.1/109
R2002	7030010040	S.RES ERJ2GEJ-JPW	B	36.9/12.7
R2003	7030008240	S.RES ERJ12Y0R00U	T	55.7/7.9
R2004	7030004990	S.RES ERJ2GEJ 221 X (220)	B	59.8/9.2
R2005	7030004990	S.RES ERJ2GEJ 221 X (220)	B	59.1/3
R2006	7030004990	S.RES ERJ2GEJ 221 X (220)	B	60.7/3.6
R2007	7030004990	S.RES ERJ2GEJ 221 X (220)	B	60.7/4.7
R2008	7030010040	S.RES ERJ2GEJ-JPW	B	34/17.6
R2010	7030010040	S.RES ERJ2GEJ-JPW	B	32.5/15.1
R2011	7030006210	S.RES ERJ12YJ4R7U (4.7)	B	13.1/26.3
R2012	7030005120	S.RES ERJ2GEJ 102 X (1K)	B	32.4/17.3
R2101	7030005090	S.RES ERJ2GEJ 104 X (100K)	T	26/113.8
R2102	7030005090	S.RES ERJ2GEJ 104 X (100K)	T	33.1/114.3
R2103	7030005090	S.RES ERJ2GEJ 104 X (100K)	T	30.7/123.2
R2104	7030005090	S.RES ERJ2GEJ 104 X (100K)	T	28.1/123.2
R2105	7030005090	S.RES ERJ2GEJ 104 X (100K)	T	32.3/118.7
R2106	7030005720	S.RES ERJ2GEJ 563 X (56K)	T	25/115.5
R2107	7030005720	S.RES ERJ2GEJ 563 X (56K)	T	31.5/114.6
R2108	7030005100	S.RES ERJ2GEJ 154 X (150K)	T	30.7/122.3
R2109	7030007350	S.RES ERJ2GEJ 393 X (39K)	T	27.1/122.3
R2110	7030005090	S.RES ERJ2GEJ 104 X (100K)	T	44.3/111.8
R2111	7030005090	S.RES ERJ2GEJ 104 X (100K)	T	44.7/110
R2112	7030005090	S.RES ERJ2GEJ 104 X (100K)	T	54.1/110.8
R2113	7030005090	S.RES ERJ2GEJ 104 X (100K)	T	54.1/111.7
R2114	7030005100	S.RES ERJ2GEJ 154 X (150K)	T	44.7/112.7
R2115	7030005100	S.RES ERJ2GEJ 154 X (150K)	T	44.7/109.1
R2116	7030005100	S.RES ERJ2GEJ 154 X (150K)	T	54.4/109.9
R2117	7030005100	S.RES ERJ2GEJ 154 X (150K)	T	54.1/112.6
R2118	7030005090	S.RES ERJ2GEJ 104 X (100K)	T	54.1/120.6
R2119	7030005090	S.RES ERJ2GEJ 104 X (100K)	T	54.1/121.8
R2120	7030008300	S.RES ERJ2GEJ 184 X (180K)	T	44.8/122.1
R2121	7030008300	S.RES ERJ2GEJ 184 X (180K)	T	42.9/121.3
R2122	7030005100	S.RES ERJ2GEJ 154 X (150K)	T	54.1/119.7
R2123	7030006610	S.RES ERJ2GEJ 394 X (390K)	T	54.2/122.8
R2124	7030005110	S.RES ERJ2GEJ 224 X (220K)	T	44.8/123
R2125	7030005110	S.RES ERJ2GEJ 224 X (220K)	T	44.8/119.4
R2126	7030010040	S.RES ERJ2GEJ-JPW	T	33.1/116.4
R2128	7030005000	S.RES ERJ2GEJ 471 X (470)	T	32.3/123.2
R2129	7030005000	S.RES ERJ2GEJ 471 X (470)	T	54.1/118.8
R2131	7030005090	S.RES ERJ2GEJ 104 X (100K)	B	39.8/122
R2132	7030005090	S.RES ERJ2GEJ 104 X (100K)	T	42.8/115.1
R2133	7030005090	S.RES ERJ2GEJ 104 X (100K)	T	40.6/114.1
R2134	7030005090	S.RES ERJ2GEJ 104 X (100K)	T	36.5/114.1
R2135	7030005090	S.RES ERJ2GEJ 104 X (100K)	T	34.9/114.2
R2136	7030005000	S.RES ERJ2GEJ 471 X (470)	T	26.5/123.2
R2137	7030005230	S.RES ERJ2GEJ 334 X (330K)	T	43.3/123.7
R2138	7030005230	S.RES ERJ2GEJ 334 X (330K)	T	42.9/122.2
R2139	7030004980	S.RES ERJ2GEJ 101 X (100)	T	25/116.4
R2140	7030004980	S.RES ERJ2GEJ 101 X (100)	T	32/115.5
R2141	7030010040	S.RES ERJ2GEJ-JPW	T	44.7/113.6
R2142	7030010040	S.RES ERJ2GEJ-JPW	T	52.7/108.9
R2143	7030010040	S.RES ERJ2GEJ-JPW	T	56/109.9
R2144	7030010040	S.RES ERJ2GEJ-JPW	T	51.3/115.1
R2145	7030010040	S.RES ERJ2GEJ-JPW	T	58.1/123.6
R2146	7030010040	S.RES ERJ2GEJ-JPW	T	46.3/124
R2147	7030010040	S.RES ERJ2GEJ-JPW	T	46/118.5
R2151	7030005240	S.RES ERJ2GEJ 473 X (47K)	T	52.3/101.7
R2152	7030005120	S.RES ERJ2GEJ 102 X (1K)	T	56.5/107.1
R2153	7030005240	S.RES ERJ2GEJ 473 X (47K)	T	24.8/112.5
R2154	7030005120	S.RES ERJ2GEJ 102 X (1K)	T	25.6/111.6
R2155	7030005240	S.RES ERJ2GEJ 473 X (47K)	T	46.1/104

[MAIN UNIT]

REF NO.	PARTS NO.	DESCRIPTION	M.	H/V LOCATION
R2163	7030005530	S.RES ERJ2GEJ 100 X (10)	B	30.9/95.9
R2164	7030005530	S.RES ERJ2GEJ 100 X (10)	B	30.2/94.7
R2165	7030005530	S.RES ERJ2GEJ 100 X (10)	B	29.3/95.9
R2166	7030005530	S.RES ERJ2GEJ 100 X (10)	T	51.8/93.3
R2167	7030005530	S.RES ERJ2GEJ 100 X (10)	T	51.8/94.2
R2168	7030005530	S.RES ERJ2GEJ 100 X (10)	T	51.8/95.1
R2169	7030005120	S.RES ERJ2GEJ 102 X (1K)	T	8.8/118.5
R2170	7030005170	S.RES ERJ2GEJ 474 X (470K)	T	5/104.5
R2171	7030005240	S.RES ERJ2GEJ 473 X (47K)	T	9.7/114.2
R2172	7030005240	S.RES ERJ2GEJ 473 X (47K)	T	5/112.4
R2174	7030005170	S.RES ERJ2GEJ 474 X (470K)	T	5/105.4
R2175	7030005170	S.RES ERJ2GEJ 474 X (470K)	T	5/111.5
R2176	7030005170	S.RES ERJ2GEJ 474 X (470K)	T	11.3/114.2
R2177	7030005210	S.RES ERJ2GEJ 822 X (8.2K)	T	3.3/108
R2202	7030010040	S.RES ERJ2GEJ-JPW	T	26.5/124.1
R2203	7030005080	S.RES ERJ2GEJ 823 X (82K)	T	25/122.4
R2204	7030005050	S.RES ERJ2GEJ 103 X (10K)	T	23.4/122.7
R2205	7030005040	S.RES ERJ2GEJ 472 X (4.7K)	T	18.2/118.2
R2206	7030007270	S.RES ERJ2GEJ 151 X (150)	T	12.6/118.8
R2207	7030005090	S.RES ERJ2GEJ 104 X (100K)	T	23.1/121.5
R2208	7030005090	S.RES ERJ2GEJ 104 X (100K)	T	19/119.2
R2209	7030004980	S.RES ERJ2GEJ 101 X (100)	T	21/116.5
R2211	7030005230	S.RES ERJ2GEJ 334 X (330K)	T	14.5/123.3
R2212	7030005310	S.RES ERJ2GEJ 124 X (120K)	T	12.9/123.4
R2213	7030008010	S.RES ERJ2GEJ 123 X (12K)	T	12.4/124.2
R2214	7030005050	S.RES ERJ2GEJ 103 X (10K)	T	8.8/117.6
R2215	7030005040	S.RES ERJ2GEJ 472 X (4.7K)	T	11.1/120.6
R2217	7030007280	S.RES ERJ2GEJ 331 X (330)	T	24.9/121.5
R2218	7030007270	S.RES ERJ2GEJ 151 X (150)	T	15.5/127.5
R2219	7030007280	S.RES ERJ2GEJ 331 X (330)	T	17.7/126.1
R2220	7030008280	S.RES ERJ2GEJ 271 X (270)	T	16.1/126.1
R2221	7030005050	S.RES ERJ2GEJ 103 X (10K)	T	9.5/120.5
R2230	7030010900	S.RES ERJ3GEVJ 750 V (75)	T	40.4/105.8
R2231	7030005050	S.RES ERJ2GEJ 103 X (10K)	T	4.5/118.2
R2232	7030005050	S.RES ERJ2GEJ 103 X (10K)	T	54.7/117.5
R2251	7030004990	S.RES ERJ2GEJ 221 X (220)	T	6.1/96.9
R2254	7030004990	S.RES ERJ2GEJ 221 X (220)	B	6.8/100.7
R2255	7030004990	S.RES ERJ2GEJ 221 X (220)	B	6.8/101.6
R2256	7030004990	S.RES ERJ2GEJ 221 X (220)	B	6.8/102.5
R2257	7030004990	S.RES ERJ2GEJ 221 X (220)	B	75.3/109
R2258	7030004990	S.RES ERJ2GEJ 221 X (220)	B	70.9/106.5
R2259	7030004990	S.RES ERJ2GEJ 221 X (220)	B	75.3/107.8
R2260	7030004990	S.RES ERJ2GEJ 221 X (220)	B	71/105.6
R2261	7030004990	S.RES ERJ2GEJ 221 X (220)	B	75.3/106.6
R2262	7030004990	S.RES ERJ2GEJ 221 X (220)	B	71.4/104.5
R2263	7030004990	S.RES ERJ2GEJ 221 X (220)	B	75.6/104.5
R2264	7030004990	S.RES ERJ2GEJ 221 X (220)	B	72.2/103.6
R2267	7030004990	S.RES ERJ2GEJ 221 X (220)	B	78.6/104.1
R2268	7030004990	S.RES ERJ2GEJ 221 X (220)	B	78.6/103.2
R2269	7030004990	S.RES ERJ2GEJ 221 X (220)	T	78.6/102.3
R2270	7030004970	S.RES ERJ2GEJ 470 X (47)	T	76.6/101.8
R2271	7030004990	S.RES ERJ2GEJ 221 X (220)	B	76.6/100.9
R2272	7030004990	S.RES ERJ2GEJ 221 X (220)	B	78.1/97.8
R2273	7030004990	S.RES ERJ2GEJ 221 X (220)	B	78.1/98.9
R2274	7030005000	S.RES ERJ2GEJ 471 X (470)	T	14.1/89.7
R2277	7030005090	S.RES ERJ2GEJ 104 X (100K)	T	19.2/89.9
R2278	7030005090	S.RES ERJ2GEJ 104 X (100K)	T	19.2/90.4
R2279	7030005120	S.RES ERJ2GEJ 102 X (1K)	T	66.2/107
R2280	7030004980	S.RES ERJ2GEJ 101 X (100)	B	69.7/110.2
R2281	7030004990	S.RES ERJ2GEJ 221 X (220)	T	7.1/101.5
R2301	7030007250	S.RES ERJ2GEJ 220 X (22)	T	28.3/106.6
R2302	7030008290	S.RES ERJ2GEJ 183 X (18K)	T	28.9/108
R2303	7030005710	S.RES ERJ2GEJ 121 X (120)	T	31.2/110.8
R2304	7030010900	S.RES ERJ3GEVJ 750 V (75)	T	77.7/112
R2311	7030006101	S.RES ERA3YED 183V (18K)	B	67.6/107.1
R2312	7030006571	S.RES ERA3YED 392V (3.9K)	B	68.5/108.3
R2401	7030005000	S.RES ERJ2GEJ 471 X (470)	B	78.7/29.6
R2402	7030005050	S.RES ERJ2GEJ 103 X (10K)	B	81.3/29.6
R2405	7030010040	S.RES ERJ2GEJ-JPW	T	91.9/5.8
R2406	7030004990	S.RES ERJ2GEJ 221 X (220)	B	90.3/100.7
R2408	7030004970	S.RES ERJ2GEJ 470 X (47)	B	90.3/99.8
R2409	7030004990	S.RES ERJ2GEJ 221 X (220)	B	87.1/68.1
R2410	7030004990	S.RES ERJ2GEJ 221 X (220)	B	90.3/65.5
R2411	7030004990	S.RES ERJ2GEJ 221 X (220)	B	87.3/67.2
R2412	7030004990	S.RES ERJ2GEJ 221 X (220)	B	91.3/68.5
R2413	7030004990	S.RES ERJ2GEJ 221 X (220)	B	87.3/66.3
R2414	7030004990	S.RES ERJ2GEJ 221 X (220)	B	90.3/64.6
R2415	7030004990	S.RES ERJ2GEJ 221 X (220)	B	87.3/65.4
R2416	7030004990	S.RES ERJ2GEJ 221 X (220)	B	90.3/63.7
R2417	7030010040	S.RES ERJ2GEJ-JPW	B	51.4/141.2
R2418	7030010040	S.RES ERJ2GEJ-JPW	T	93.3/7.8
R2501	7030005090	S.RES ERJ2GEJ 104 X (100K)	B	8.3/93.3
R2502	7030005090	S.RES ERJ2GEJ 104 X (100K)	B	8/95.1
R2503	7030008410	S.RES ERJ2GEJ 392 X (3.9K)	B	8/91.5
R2505	7030008410	S.RES ERJ2GEJ 392 X (3.9K)	B	10.6/89.2
R2506	7030005720	S.RES ERJ2GEJ 563 X (56K)	B	9.4/90
R2507	7030004980	S.RES ERJ2GEJ 101 X (100)	B	16.4/89.9
R2508	7030005120	S.RES ERJ2GEJ 102 X (1K)	B	10.4/88.3
R2509	7030005120	S.RES ERJ2GEJ 102 X (1K)	B	15.7/88.3
R2510	7030005120	S.RES ERJ2GEJ 102 X (1K)	B	17.4/92.8
R2513	7030005000	S.RES ERJ2GEJ 471 X (470)	B	15.8/94
R2551	7030005120	S.RES ERJ2GEJ 102 X (1K)	B	42.9/123.2
R2552	7030005120	S.RES ERJ2GEJ 102 X (1K)	B	42.9/122.3
R2555	7030004980	S.RES ERJ2GEJ 101 X (100)	B	51.4/119.3
R2556	7030005040	S.RES ERJ2GEJ 472 X (4.7K)	B	44.5/125.2
R2559	7030010040	S.RES ERJ2GEJ-JPW	B	49.5/124.6
R2560	7030008410	S.RES ERJ2GEJ 392 X (3.9K)	B	49.5/125.5
R2561	7030008410	S.RES ERJ2GEJ 392 X (3.9K)	B	52.9/124.7

[MAIN UNIT]

REF NO.	PARTS NO.	DESCRIPTION	M.	H/V LOCATION
R2562	7030008410	S.RES ERJ2GEJ 392 X (3.9K)	B	53.9/122.8
R2564	7030005090	S.RES ERJ2GEJ 104 X (100K)	B	46.1/126.1
R2565	7030009280	S.RES ERJ2GEJ 391 X	B	41.8/116.9
R2566	7030005050	S.RES ERJ2GEJ 103 X (10K)	B	59/126.8
R2567	7030005050	S.RES ERJ2GEJ 103 X (10K)	B	60.6/126.8
R2568	7030005040	S.RES ERJ2GEJ 472 X (4.7K)	B	47.8/124.7
R2569	7030005040	S.RES ERJ2GEJ 472 X (4.7K)	B	46.1/125.2
R2601	7030010040	S.RES ERJ2GEJ-JPW	B	66.7/123.4
R2602	7030005000	S.RES ERJ2GEJ 471 X (470)	B	57.2/122.6
R2603	7030005240	S.RES ERJ2GEJ 473 X (47K)	B	63.4/121.7
R2604	7030008400	S.RES ERJ2GEJ 182 X (1.8K)	B	66.7/124.3
R2605	7030005120	S.RES ERJ2GEJ 102 X (1K)	B	65.5/126
R2607	7030010040	S.RES ERJ2GEJ-JPW	T	40.5/132.1
R2608	7030009320	S.RES ERJ2GEJ 477 X (4.7)	B	83.9/132.7
R2611	7030005050	S.RES ERJ2GEJ 103 X (10K)	B	33.9/124.8
R2612	7030005090	S.RES ERJ2GEJ 104 X (100K)	B	38.4/125.4
R2613	7030005080	S.RES ERJ2GEJ 823 X (82K)	B	38.4/123.6
R2614	7030005120	S.RES ERJ2GEJ 102 X (1K)	B	34.7/126.6
R2617	7030005040	S.RES ERJ2GEJ 472 X (4.7K)	T	63.3/111.1
R2618	7030007340	S.RES ERJ2GEJ 153 X (15K)	T	69.3/112.6
R2619	7030005060	S.RES ERJ2GEJ 333 X (33K)	T	63.3/112.1
R2620	7030005120	S.RES ERJ2GEJ 102 X (1K)	T	78.1/100.3
R2621	7030005120	S.RES ERJ2GEJ 102 X (1K)	T	78.1/99.4
R2623	7030005240	S.RES ERJ2GEJ 473 X (47K)	T	9.8/112.9
R2624	7030004970	S.RES ERJ2GEJ 470 X (47)	B	86.8/122
R2628	7030005240	S.RES ERJ2GEJ 473 X (47K)	B	61.8/121.7
C5	4030017460	S.CER ECJ0EB1E102K	B	47.5/30.7
C6	4030018960	S.CER C3216 JB 1C 106MT-N	T	66.3/12
C7	4030017330	S.CER ECJ0EF1C104Z	T	73.1/12.2
C8	4030017330	S.CER ECJ0EF1C104Z	T	77.2/9.1
C9	4030017330	S.CER ECJ0EF1C104Z	T	73.1/14
C10	4030017330	S.CER ECJ0EF1C104Z	T	74.8/14.9
C11	4030017330	S.CER ECJ0EF1C104Z	T	73/17.6
C12	4030017330	S.CER ECJ0EF1C104Z	T	76.4/16.7
C13	4030017330	S.CER ECJ0EF1C104Z	T	72.5/16.7
C14	4030017460	S.CER ECJ0EB1E102K	T	67.7/16.5
C15	4030017460	S.CER ECJ0EB1E102K	T	63.7/14.7
C16	4030017460	S.CER ECJ0EB1E102K	T	63.7/15.6
C17	4030017460	S.CER ECJ0EB1E102K	T	62.3/18.8
C18	4030017620	S.CER ECJ0EC1H100C	T	60.7/18.9
C21	4030017730	S.CER ECJ0EB1E471K	T	64.5/13.8
C25	4030017580	S.CER ECJ0EC1H060C	T	55.2/17.8
C26	4030017660	S.CER ECJ0EC1H330J	T	55.2/18.7
C27	4030017780	S.CER ECJ0EB1E472K	T	51.6/20.5
C28	4030017530	S.CER ECJ0EC1H0R5B	T	53.8/17.1
C29	4030017590	S.CER ECJ0EC1H070C	T	51.7/19.6
C30	4030017730	S.CER ECJ0EB1E471K	T	45.8/17.5
C31	4030017530	S.CER ECJ0EC1H0R5B	T	53.8/16.2
C32	4030017660	S.CER ECJ0EC1H330J	T	52.1/17.4
C33	4030017580	S.CER ECJ0EC1H060C	T	52.2/16.5
C34	4030017380	S.CER ECJ0EC1H050B	T	56/15
C35	4030017380	S.CER ECJ0EC1H050B	T	55.9/12.4
C36	4030017730	S.CER ECJ0EB1E471K	T	51/15.6
C37	4030017780	S.CER ECJ0EB1E472K	T	70.4/11.3
C38	4030017780	S.CER ECJ0EB1E472K	T	45.8/18.4
C40	4030017730	S.CER ECJ0EB1E471K	T	73.1/13.1
C41	4030017730	S.CER ECJ0EB1E471K	T	66.9/19.6
C42	4030017730	S.CER ECJ0EB1E471K	T	70.4/12.2
C43	4030017420	S.CER ECJ0EC1H470J	T	45.8/16.6
C44	4030017420	S.CER ECJ0EC1H470J	T	48/11.7
C50	4030017640	S.CER ECJ0EC1H150J	B	80.4/13.6
C51	4030017640	S.CER ECJ0EC1H150J	B	79.9/11.8
C52	4030017430	S.CER ECJ0EC1H101J	B	79.9/12.7
C53	4030016930	S.CER ECJ0EB1A104K	B	79.6/22
C54	4030016930	S.CER ECJ0EB1A104K	T	79.8/12.9
C55	4030016930	S.CER ECJ0EB1A104K	T	78.1/17.7
C56	4030018860	S.CER ECJ0EB0J105K	B	65.5/22.9
C58	4030017710	S.CER ECJ0EC1H181J	T	72.2/19.4
C59	4030017710	S.CER ECJ0EC1H181J	T	65.4/23.7
C101	4030017330	S.CER ECJ0EF1C104Z	T	10.3/15.5
C102	4030017330	S.CER ECJ0EF1C104Z	T	13.2/16.9
C103	4030017330	S.CER ECJ0EF1C104Z	T	13.2/17.8
C104	4030017330	S.CER ECJ0EF1C104Z	T	3.3/29.9
C105	4030017330	S.CER ECJ0EF1C104Z	T	13.2/16.9
C106	4030017850	S.CER C2012 CH 1H 272J-T	T	23.7/10.9
C107	4030017330	S.CER ECJ0EF1C104Z	T	19.2/12.9
C108	4030017330	S.CER ECJ0EF1C104Z	T	36.5/16.6
C109	4030017330	S.CER ECJ0EF1C104Z	T	25.2/14
C110	4030017800	S.CER C1608 CH 1H 561J-T	T	27.8/7.7
C111	4030018590	S.CER C1608 CH 1H 122J-T	T	29/15
C112	4030017330	S.CER ECJ0EF1C104Z	T	23.8/5.3
C114	4030018600	S.CER C1608 CH 1H 152J-T	T	25.1/15
C115	4030008490	S.CER C2012 JB 1H 682K-T	T	24.8/16.7
C116	4030017850	S.CER C2012 CH 1H 272J-T	T	24.8/18.4

[MAIN UNIT]

REF NO.	PARTS NO.	DESCRIPTION	M.	H/V LOCATION
C209	4030017680	S.CER ECJ0EC1H820J	T	18.5/41.4
C210	4030017610	S.CER ECJ0EC1H090C	T	18.5/40.5
C211	4030017700	S.CER ECJ0EC1H151J	T	18.5/42.3
C212	4030017650	S.CER ECJ0EC1H270J	T	23.2/39.2
C213	4030017510	S.CER ECJ0EC1H680J	T	21.8/43.4
C214	4030018820	S.CER ECJ0EB1H561K	T	31.7/54.4
C215	4030017440	S.CER ECJ0EC1H221J	T	37/54.6
C226	4030017330	S.CER ECJ0EF1C104Z	T	24.1/43.4
C227	4030017330	S.CER ECJ0EF1C104Z	T	19.7/30.3
C228	4030017430	S.CER ECJ0EC1H101J	T	28.1/39.2
C229	4030017440	S.CER ECJ0EC1H221J	T	29.7/39.2
C237	4030017500	S.CER ECJ0EC1H560J	T	28.1/38.2
C238	4030017330	S.CER ECJ0EF1C104Z	T	21.9/30.9
C239	4030017330	S.CER ECJ0EF1C104Z	B	24.7/41.4
C240	4030017400	S.CER ECJ0EC1H220J	B	28.1/43.6
C241	4030017580	S.CER ECJ0EC1H060C	B	31.5/40.1
C242	4030017680	S.CER ECJ0EC1H820J	B	31.5/41
C243	4030018630	S.CER C2012 CH 1H 472J-T	T	32.5/57.8
C244	4030018680	S.CER C2012 CH 1H 822J-T	T	36.8/57.8
C245	4030017330	S.CER ECJ0EF1C104Z	T	45.8/63.2
C246	4030018600	S.CER C1608 CH 1H 152J-T	T	36.5/56.1
C247	4030017860	S.CER C2012 CH 1H 332J-T	T	40.3/54.1
C248	4030018630	S.CER C2012 CH 1H 472J-T	T	43.8/57.9
C249	4030017330	S.CER ECJ0EF1C104Z	B	24.9/56.4
C250	4030017330	S.CER ECJ0EF1C104Z	B	24.9/53.3
C251	4030018590	S.CER C1608 CH 1H 122J-T	T	30.5/51
C252	4030011340	S.CER C1608 CH 1H 471J-T	T	31.9/48.6
C253	4030018630	S.CER C2012 CH 1H 472J-T	T	29.1/53.3
C254	4030018620	S.CER C1608 CH 1H 222J-T	T	38.1/50.8
C255	4030018580	S.CER C1608 CH 1H 821J-T	T	32.6/55.9
C256	4030010760	S.CER C1608 CH 1H 331J-T	T	38.1/52.1
C257	4030018610	S.CER C1608 CH 1H 182J-T	T	34.4/53.4
C258	4030017870	S.CER C1608 CH 1H 681J-T	T	40.7/52.2
C259	4030018590	S.CER C1608 CH 1H 122J-T	T	37.1/53.4
C260	4030017870	S.CER C1608 CH 1H 681J-T	T	40.7/47.9
C261	4030017780	S.CER ECJ0EB1E472K	B	37.9/56.2
C262	4030017780	S.CER ECJ0EB1E472K	B	37.9/53.8
C263	4030017330	S.CER ECJ0EF1C104Z	B	24.5/50.2
C264	4030017330	S.CER ECJ0EF1C104Z	B	23.9/47.1
C265	4030011280	S.CER C1608 CH 1H 271J-T	B	36.4/46
C266	4030017700	S.CER ECJ0EC1H151J	B	31/44.1
C267	4030018590	S.CER C1608 CH 1H 122J-T	B	36.4/49.6
C268	4030018580	S.CER C1608 CH 1H 821J-T	B	31.7/42.9
C269	4030017710	S.CER ECJ0EC1H181J	B	36.5/47.1
C270	4030017430	S.CER ECJ0EC1H101J	B	32.6/44.1
C271	4030011330	S.CER C1608 CH 1H 391J-T	B	36.4/48.3
C272	4030011280	S.CER C1608 CH 1H 271J-T	B	36.3/43.8
C273	4030011330	S.CER C1608 CH 1H 391J-T	B	38.8/47.3
C274	4030017730	S.CER ECJ0EB1E471K	B	34.2/43.7
C275	4030017780	S.CER ECJ0EB1E472K	B	42.9/49.6
C276	4030017780	S.CER ECJ0EB1E472K	B	39.2/46.2
C278	4030017330	S.CER ECJ0EF1C104Z	T	30.9/31.8
C279	4030017330	S.CER ECJ0EF1C104Z	T	31/43.8
C281	4030017330	S.CER ECJ0EF1C104Z	T	33/31.7
C282	4030017580	S.CER ECJ0EC1H060C	B	31.5/39.2
C283	4030017330	S.CER ECJ0EF1C104Z	B	35.8/35.8
C284	4030017780	S.CER ECJ0EB1E472K	B	42.6/43.3
C285	4030017380	S.CER ECJ0EC1H050B	B	33.1/39.5
C286	4030017510	S.CER ECJ0EC1H680J	B	34.7/39.5
C287	4030017690	S.CER ECJ0EC1H121J	B	36.5/37.8
C288	4030017680	S.CER ECJ0EC1H820J	B	34.2/36.3
C289	4030017420	S.CER ECJ0EC1H470J	B	36.3/36.7
C290	4030018600	S.CER C1608 CH 1H 152J-T	B	38.8/37.6
C291	4030017680	S.CER ECJ0EC1H820J	B	37.9/36.5
C292	4030017330	S.CER ECJ0EF1C104Z	T	30.9/30
C293	4030017780	S.CER ECJ0EB1E472K	B	38.1/34.8
C294	4030017440	S.CER ECJ0EC1H221J	T	38.6/49.6
C295	4030017510	S.CER ECJ0EC1H680J	T	40.4/51.2
C301	4030017330	S.CER ECJ0EF1C104Z	T	47/30.1
C302	4030017330	S.CER ECJ0EF1C104Z	B	56.1/30.7
C303	4030017330	S.CER ECJ0EF1C104Z	T	51.5/33.6
C305	4030017330	S.CER ECJ0EF1C104Z	T	59.9/34.7
C307	4030017330	S.CER ECJ0EF1C104Z	T	59.9/35.6
C308	4030017330	S.CER ECJ0EF1C104Z	T	60.7/36.5
C309	4030017330	S.CER ECJ0EF1C104Z	T	62.8/36.9
C310	4030017330	S.CER ECJ0EF1C104Z	T	60.9/30.1
C311	4030017330	S.CER ECJ0EF1C104Z	T	50.1/32.6
C312	4030017330	S.CER ECJ0EF1C104Z	T	64.5/36.1
C313	4030017380	S.CER ECJ0EC1H050B	T	46.4/23
C314	4030017660	S.CER ECJ0EC1H330J	T	64.8/35.2
C315	4030017340	S.CER ECJ0EC1H010B	T	49.2/22.9
C316	4030017630	S.CER ECJ0EC1H120J	T	66.1/36.1
C317	4030017600	S.CER ECJ0EC1H080C	T	51.4/23.8
C318	4030017680	S.CER ECJ0EC1H820J	T	66.4/35.2
C319	4030017570	S.CER ECJ0EC1H040B	T	53/24.3
C320	4030017570	S.CER ECJ0EC1H040B	T	69.6/37.1
C321	4030017580	S.CER ECJ0EC1H060C	T	58.6/24.4
C322	4030017670	S.CER ECJ0EC1H390J	T	69/32.2
C323	4030017590	S.CER ECJ0EC1H070C	T	60.4/24.2
C324	4030017330	S.CER ECJ0EF1C104Z	T	74.7/38.6
C325	4030017360	S.CER ECJ0EC1H030B	T	62/24.6
C326	4030017780	S.CER ECJ0EB1E472K	T	47.6/47.1
C401	4030017330	S.CER ECJ0EF1C104Z	T	71/30.8
C413	4030017330	S.CER ECJ0EF1C104Z	T	80.6/23.9
C415	4030017330	S.CER ECJ0EF1C104Z	T	71.9/24
C418	4030017330	S.CER ECJ0EF1C104Z	T	67.4/24.8
C422	4030017330	S.CER ECJ0EF1C104Z	T	80/28.6
C423	4030017330	S.CER ECJ0EF1C104Z	T	67.4/23.9

[MAIN UNIT]

REF NO.	PARTS NO.	DESCRIPTION	M.	H/V LOCATION
C424	4030017330	S.CER ECJ0EF1C104Z	T	83.2/21
C425	4030017330	S.CER ECJ0EF1C104Z	T	86.9/27.6
C426	4030017330	S.CER ECJ0EF1C104Z	T	78.6/19.8
C427	4030017330	S.CER ECJ0EF1C104Z	T	80/27.7
C429	4030017460	S.CER ECJ0EB1E102K	T	81.8/25.3
C431	4030017330	S.CER ECJ0EF1C104Z	T	88.5/26.7
C432	4030017780	S.CER ECJ0EB1E472K	B	88.5/19.3
C433	4030017780	S.CER ECJ0EB1E472K	B	88.8/20.3
C434	4030017780	S.CER ECJ0EB1E472K	T	86.7/22.9
C511	4030017460	S.CER ECJ0EB1E102K	T	41.8/26.8
C512	4030017780	S.CER ECJ0EB1E472K	T	93.6/33.5
C513	4030017330	S.CER ECJ0EF1C104Z	T	88.4/28.7
C514	4030017330	S.CER ECJ0EF1C104Z	B	88.3/31.3
C515	4030017780	S.CER ECJ0EB1E472K	T	81.7/33.2
C516	4030017580	S.CER ECJ0EC1H060C	T	86.1/38.7
C518	4030017570	S.CER ECJ0EC1H040B	T	86.9/36.5
C525	4030017330	S.CER ECJ0EF1C104Z	T	81.8/32.3
C526	4030016790	S.CER ECJ0EB1C103K	T	77.9/38.2
C527	4030017330	S.CER ECJ0EF1C104Z	T	79.5/37.9
C528	4030017330	S.CER ECJ0EF1C104Z	T	89.7/35.1
C529	4030017670	S.CER ECJ0EC1H390J	T	91.3/33.8
C530	4030017460	S.CER ECJ0EB1E102K	B	87.7/34.1
C602	4030017570	S.CER ECJ0EC1H040B	B	85.7/39.6
C603	4030017780	S.CER ECJ0EB1E472K	T	89.1/40.1
C604	4030017780	S.CER ECJ0EB1E472K	T	94/46.5
C605	4030017620	S.CER ECJ0EC1H100C	T	86/44.2
C606	4030017620	S.CER ECJ0EC1H100C	B	85.7/41.4
C608	4030017550	S.CER ECJ0EC1H1R5B	B	82.5/43.8
C609	4030017580	S.CER ECJ0EC1H060C	B	78.6/46.8
C610	4030017620	S.CER ECJ0EC1H100C	B	82.5/44.8
C611	4030017780	S.CER ECJ0EB1E472K	B	85.1/37.5
C612	4030017610	S.CER ECJ0EC1H090C	T	79.5/40.2
C613	4030017620	S.CER ECJ0EC1H100C	T	76.5/43.7
C614	4030017780	S.CER ECJ0EB1E472K	T	69.6/38.8
C615	4030017780	S.CER ECJ0EB1E472K	T	64.3/43
C616	4030017780	S.CER ECJ0EB1E472K	T	77.7/39.5
C617	4030017620	S.CER ECJ0EC1H100C	B	85.7/40.2
C618	4030017620	S.CER ECJ0EC1H100C	B	80.9/44.8
C701	4030017330	S.CER ECJ0EF1C104Z	T	59/50.6
C702	4030017330	S.CER ECJ0EF1C104Z	T	63/45
C703	4510008630	S.ELE 16 CE 47 FE	B	59/44.9
C704	4030017780	S.CER ECJ0EB1E472K	T	58.6/42.9
C705	4030017600	S.CER ECJ0EC1H080C	T	59.6/45.1
C707	4030017330	S.CER ECJ0EF1C104Z	T	64.2/52.9
C708	4030017460	S.CER ECJ0EB1E102K	T	64.5/55
C709	4030017780	S.CER ECJ0EB1E472K	T	60.7/58.6
C710	4030017780	S.CER ECJ0EB1E472K	T	62.3/58.6
C711	4030017460	S.CER ECJ0EB1E102K	T	57.1/50.6
C712	4030017600	S.CER ECJ0EC1H080C	T	52.4/50.2
C714	4030017460	S.CER ECJ0EB1E102K	T	56.2/49.7
C715	4030017780	S.CER ECJ0EB1E472K	T	52.1/53.2
C716	4030017340	S.CER ECJ0EC1H010B	T	55.3/55.1
C717	4030017780	S.CER ECJ0EB1E472K	T	51.2/52.3
C718	4030017780	S.CER ECJ0EB1E472K	T	56.9/55.1
C719	4030017340	S.CER ECJ0EC1H010B	T	61.1/53.9
C720	4030017380	S.CER ECJ0EC1H050B	T	59.3/42
C721	4030017780	S.CER ECJ0EB1E472K	T	51.2/49.6
C801	4030017330	S.CER ECJ0EF1C104Z	T	71.5/64
C803	4030017780	S.CER ECJ0EB1E472K	T	65.3/61.8
C804	4030017330	S.CER ECJ0EF1C104Z	T	91.9/58
C805	4030017460	S.CER ECJ0EB1E102K	T	83.5/55.8
C807	4030017330	S.CER ECJ0EF1C104Z	T	60.6/66.7
C808	4030017870	S.CER C1608 CH 1H 681J-T	T	60.3/65.5
C809	4030018630	S.CER C2012 CH 1H 472J-T	T	57.4/66.8
C810	4030017700	S.CER ECJ0EC1H151J	T	63.9/68.5
C811	4030017700	S.CER ECJ0EC1H151J	T	63.9/69.4
C812	4030017700	S.CER ECJ0EC1H151J	T	60.1/69.4
C813	4030017700	S.CER ECJ0EC1H151J	T	60.1/68.5
C814	4030017330	S.CER ECJ0EF1C104Z	T	88.5/57.1
C815	4030017460	S.CER ECJ0EB1E102K	T	86.6/60.6
C816	4030017400	S.CER ECJ0EC1H220J	T	85.7/59.7
C817	4030017400	S.CER ECJ0EC1H220J	T	84/61.7
C818	4030018590	S.CER C1608 CH 1H 122J-T	T	54.6/65.6
C819	4030017850	S.CER C2012 CH 1H 272J-T	T	51.6/65.8
C901	4030017330	S.CER ECJ0EF1C104Z	T	38.4/71.3
C910	4030017710	S.CER ECJ0EC1H181J	T	39.2/65.6
C911	4030017700	S.CER ECJ0EC1H151J	T	47.9/74.7
C913	4030017330	S.CER ECJ0EF1C104Z	T	38.2/61.1
C914	4030017330	S.CER ECJ0EF1C104Z	T	39.2/63.6
C916	4030017330	S.CER ECJ0EF1C104Z	T	33.9/61.9
C917	4030017780	S.CER ECJ0EB1E472K	T	35.6/63.2
C918	4030017330	S.CER ECJ0EF1C104Z	T	34.2/67.5
C920	4030017460	S.CER ECJ0EB1E102K	T	38.4/74.2
C921	4030017330	S.CER ECJ0EF1C104Z	T	34.2/70.2
C922	4030017330	S.CER ECJ0EF1C104Z	T	29.4/73
C923	4030017330	S.CER ECJ0EF1C104Z	T	29.9/72.1
C924	4030017780	S.CER ECJ0EB1E472K	T	41.2/74.1
C925	4030017700	S.CER ECJ0EC1H151J	B	31.4/73
C1001	4030017780	S.CER ECJ0EB1E472K	T	31.7/71.2
C1009	4030017780	S.CER ECJ0EB1E472K		

[MAIN UNIT]

REF NO.	PARTS NO.	DESCRIPTION	M.	H/V LOCATION
C1102	4030017330	S.CER ECJ0EF1C104Z	T	4.6/78
C1104	4030017490	S.CER C1608 JB 1A 105K-T	T	2.5/87.8
C1105	4030018960	S.CER C3216 JB 1C 106MT-N	T	2.9/89.7
C1108	4030017330	S.CER ECJ0EF1C104Z	T	2.3/91.3
C1201	4030017330	S.CER ECJ0EF1C104Z	T	26.6/80.6
C1202	4030017330	S.CER ECJ0EF1C104Z	T	28.7/80.5
C1203	4030017330	S.CER ECJ0EF1C104Z	T	18.6/79.2
C1204	4030018960	S.CER C3216 JB 1C 106MT-N	T	9/76.9
C1206	4030017780	S.CER ECJ0EB1E472K	T	14.3/79.4
C1207	4030017780	S.CER ECJ0EB1E472K	T	12.7/78.5
C1208	4030018080	S.CER ECJ0EB1H182K	T	12.9/85
C1209	4030018820	S.CER ECJ0EB1H561K	T	12.9/84.1
C1210	4030017780	S.CER ECJ0EB1E472K	T	11.3/84.1
C1211	4030017490	S.CER C1608 JB 1A 105K-T	T	9.2/84.5
C1212	4030017490	S.CER C1608 JB 1A 105K-T	T	6.7/87.8
C1213	4030017330	S.CER ECJ0EF1C104Z	T	21.8/78.3
C1301	4030017330	S.CER ECJ0EF1C104Z	T	15.2/73.6
C1302	4030017330	S.CER ECJ0EF1C104Z	T	15.1/67.3
C1303	4030018860	S.CER ECJ0EB0J105K	T	11.3/67.3
C1304	4030017330	S.CER ECJ0EF1C104Z	T	14.3/69.2
C1305	4030017330	S.CER ECJ0EF1C104Z	T	11.6/65.5
C1306	4030017330	S.CER ECJ0EF1C104Z	T	10.9/60.3
C1307	4030017330	S.CER ECJ0EF1C104Z	T	16.2/65.6
C1308	4030017330	S.CER ECJ0EF1C104Z	T	14.5/60.3
C1309	4030017330	S.CER ECJ0EF1C104Z	T	3.8/50.8
C1310	4030017330	S.CER ECJ0EF1C104Z	T	16.2/62.9
C1311	4030018960	S.CER C3216 JB 1C 106MT-N	T	5.4/58.5
C1312	4030018860	S.CER ECJ0EB0J105K	T	13/66.4
C1401	4030017330	S.CER ECJ0EF1C104Z	B	46.6/77.3
C1402	4030017700	S.CER ECJ0EC1H151J	B	42/69.6
C1403	4030017650	S.CER ECJ0EC1H270J	B	45.5/71.4
C1404	4030017700	S.CER ECJ0EC1H151J	B	41.9/70.5
C1405	4030017780	S.CER ECJ0EB1E472K	B	43.6/71.4
C1406	4030017780	S.CER ECJ0EB1E472K	B	42/72.4
C1407	4030017780	S.CER ECJ0EB1E472K	B	44.6/74.3
C1408	4030017780	S.CER ECJ0EB1E472K	B	40.3/79
C1409	4030017780	S.CER ECJ0EB1E472K	B	34.7/79
C1411	4030018860	S.CER ECJ0EB0J105K	B	27/79.9
C1412	4030016950	S.CER ECJ0EB1A473K	B	27/80.8
C1413	4030017490	S.CER C1608 JB 1A 105K-T	B	20.7/77.4
C1414	4030016950	S.CER ECJ0EB1A473K	B	25/77.8
C1415	4510008640	S.ELE 6 CE 100 FE	B	13.2/81.2
C1416	4030016950	S.CER ECJ0EB1A473K	B	20.2/78.5
C1418	4030017350	S.CER ECJ0EC1H020B	B	23/86.6
C1419	4030018390	S.CER ECJ0EB1A563K	B	23/87.5
C1420	4030017420	S.CER ECJ0EC1H470J	B	17.8/83
C1421	4030018960	S.CER C3216 JB 1C 106MT-N	B	19.8/87.3
C1422	4030017640	S.CER ECJ0EC1H150J	B	17.8/82.1
C1423	4610001970	S.TRI TZC03P200A110R00 (TZC03P200A1102)	T	3.8/72.5
C1491	4030017670	S.CER ECJ0EC1H390J	[EUR] B	88.2/29.3
	4030017670	S.CER ECJ0EC1H390J	[FRA]	
	4030017670	S.CER ECJ0EC1H390J	[ESP]	
	4030017400	S.CER ECJ0EC1H220J	[USA]	
	4030017670	S.CER ECJ0EC1H390J	[EXP]	
	4030017670	S.CER ECJ0EC1H390J	[ITR]	
	4030017670	S.CER ECJ0EC1H390J	[UK]	
	4030017400	S.CER ECJ0EC1H220J	[KOR]	
	4030017670	S.CER ECJ0EC1H390J	[AUS]	
	4030017670	S.CER ECJ0EC1H390J	[CHN]	
C1493	4030017660	S.CER ECJ0EC1H330J	B	86.1/33.7
C1494	4030017670	S.CER ECJ0EC1H390J	[EUR] B	83.6/34
	4030017670	S.CER ECJ0EC1H390J	[FRA]	
	4030017670	S.CER ECJ0EC1H390J	[ESP]	
	4030017420	S.CER ECJ0EC1H470J	[USA]	
	4030017670	S.CER ECJ0EC1H390J	[EXP]	
	4030017670	S.CER ECJ0EC1H390J	[ITR]	
	4030017670	S.CER ECJ0EC1H390J	[UK]	
	4030017420	S.CER ECJ0EC1H470J	[KOR]	
	4030017670	S.CER ECJ0EC1H390J	[AUS]	
	4030017670	S.CER ECJ0EC1H390J	[CHN]	
C1495	4030011280	S.CER C1608 CH 1H 271J-T	B	84/32.9
	4030011280	S.CER C1608 CH 1H 271J-T	[FRA]	
	4030011280	S.CER C1608 CH 1H 271J-T	[ESP]	
	4030010760	S.CER C1608 CH 1H 331J-T	[USA]	
	4030011280	S.CER C1608 CH 1H 271J-T	[EXP]	
	4030011280	S.CER C1608 CH 1H 271J-T	[ITR]	
	4030011280	S.CER C1608 CH 1H 271J-T	[UK]	
	4030010760	S.CER C1608 CH 1H 331J-T	[KOR]	
	4030011280	S.CER C1608 CH 1H 271J-T	[AUS]	
	4030011280	S.CER C1608 CH 1H 271J-T	[CHN]	
C1496	4030017660	S.CER ECJ0EC1H330J	B	79.3/35.3
C1498	4030017670	S.CER ECJ0EC1H390J	[EUR] B	79.3/36.2
	4030017670	S.CER ECJ0EC1H390J	[FRA]	
	4030017670	S.CER ECJ0EC1H390J	[ESP]	
	4030017400	S.CER ECJ0EC1H220J	[USA]	
	4030017670	S.CER ECJ0EC1H390J	[EXP]	
	4030017670	S.CER ECJ0EC1H390J	[ITR]	
	4030017670	S.CER ECJ0EC1H390J	[UK]	
	4030017400	S.CER ECJ0EC1H220J	[KOR]	
	4030017670	S.CER ECJ0EC1H390J	[AUS]	
	4030017670	S.CER ECJ0EC1H390J	[CHN]	
C1501	4030017410	S.CER ECJ0EC1H240J	B	79.3/37.1
C1503	4030017330	S.CER ECJ0EF1C104Z	B	78.9/61.9
C1504	4030017510	S.CER ECJ0EC1H680J	B	80.9/36.4
C1506	4030017780	S.CER ECJ0EB1E472K	B	92.1/28.8
C1507	4030017410	S.CER ECJ0EC1H240J	B	82.5/36.4
C1508	4030017780	S.CER ECJ0EB1E472K	B	77.3/38.6

[MAIN UNIT]

REF NO.	PARTS NO.	DESCRIPTION	M.	H/V LOCATION
C1509	4030017780	S.CER ECJ0EB1E472K	B	72.4/39.1
C1510	4030017780	S.CER ECJ0EB1E472K	B	72.4/41.2
C1511	4030016790	S.CER ECJ0EB1C103K	B	86.4/56.2
C1512	4030017780	S.CER ECJ0EB1E472K	B	77/41.6
C1513	4030018900	S.CER ECJ0EB0J474K	B	73.5/55.1
C1514	4030017780	S.CER ECJ0EB1E472K	B	73.5/42.1
C1515	4030018960	S.CER C3216 JB 1C 106MT-N	B	68.3/53.7
C1516	4030017330	S.CER ECJ0EF1C104Z	B	76/51.8
C1517	4030017730	S.CER ECJ0EB1E471K	B	73.4/53.9
C1518	4030016790	S.CER ECJ0EB1C103K	B	85.5/51.4
C1519	4030018960	S.CER C3216 JB 1C 106MT-N	B	69.3/47.4
C1520	4510008630	S.ELE 16 CE 47 FE	B	91/45.4
C1521	4030017680	S.CER ECJ0EC1H820J	B	85.9/58
C1522	4030017670	S.CER ECJ0EC1H390J	T	73.2/55.3
C1523	4030017330	S.CER ECJ0EF1C104Z	T	31.2/80.4
C1524	4030017420	S.CER ECJ0EC1H470J	[EUR] B	73.6/60.5
	4030017420	S.CER ECJ0EC1H470J	[FRA]	
	4030017420	S.CER ECJ0EC1H470J	[ESP]	
	4030017510	S.CER ECJ0EC1H680J	[USA]	
	4030017420	S.CER ECJ0EC1H470J	[EXP]	
	4030017420	S.CER ECJ0EC1H470J	[ITR]	
	4030017420	S.CER ECJ0EC1H470J	[UK]	
	4030017510	S.CER ECJ0EC1H680J	[KOR]	
	4030017420	S.CER ECJ0EC1H470J	[AUS]	
	4030017420	S.CER ECJ0EC1H470J	[CHN]	
C1525	4030018900	S.CER ECJ0EB0J474K	B	85.8/59.9
C1526	4030018960	S.CER C3216 JB 1C 106MT-N	B	69.2/51.5
C1531	4030017490	S.CER C1608 JB 1A 105K-T	B	83.3/51.5
C1532	4030017780	S.CER ECJ0EB1E472K	B	81.9/41.3
C1533	4030017780	S.CER ECJ0EB1E472K	B	81.9/39.4
C1534	4030017780	S.CER ECJ0EB1E472K	B	83.5/38.5
C1601	4030017780	S.CER ECJ0EB1E472K	T	6.3/52.2
C1604	4030017780	S.CER ECJ0EB1E472K	T	5.6/50.8
C1605	4030017330	S.CER ECJ0EF1C104Z	T	8.8/48.7
C1607	4030017780	S.CER ECJ0EB1E472K	T	14.7/46
C1609	4030017490	S.CER C1608 JB 1A 105K-T	T	14.1/33.6
C1610	4030017330	S.CER ECJ0EF1C104Z	T	12.1/44.7
C1611	4030017330	S.CER ECJ0EF1C104Z	T	14.6/41.1
C1613	4030017330	S.CER ECJ0EF1C104Z	T	18.9/47.1
C1614	4030017730	S.CER ECJ0EB1E471K	T	15/36.1
C1615	4030017420	S.CER ECJ0EC1H470J	T	10.4/46.9
C1616	4550007260	S.TAN F931C475MAABMA	T	9.6/50.5
C1618	4030017430	S.CER ECJ0EC1H101J	T	12.7/26.3
C1701	4030017490	S.CER C1608 JB 1A 105K-T	B	55.1/50.4
C1702	4030017490	S.CER C1608 JB 1A 105K-T	B	55/69.6
C1801	4030017330	S.CER ECJ0EF1C104Z	B	18.4/105
C1802	4510008630	S.ELE 16 CE 47 FE	B	14.4/101.2
C1803	4030018960	S.CER C3216 JB 1C 106MT-N	B	22.3/112.1
C1804	4030017330	S.CER ECJ0EF1C104Z	B	22.8/110.6
C1901	4030017330	S.CER ECJ0EF1C104Z	T	36.2/80.4
C1902	4030017330	S.CER ECJ0EF1C104Z	T	33.7/80.4
C1903	4030017330	S.CER ECJ0EF1C104Z	B	23.3/18.8
C1904	4030017330	S.CER ECJ0EF1C104Z	B	32.5/89.8
C1905	4030017330	S.CER ECJ0EF1C104Z	B	25.9/33.8
C1906	4030017330	S.CER ECJ0EF1C104Z	B	25.9/32.9
C1907	4030017330	S.CER ECJ0EF1C104Z	T	41.6/80.3
C1908	4030017330	S.CER ECJ0EF1C104Z	T	38.4/80.7
C1909	4030017330	S.CER ECJ0EF1C104Z	B	21.6/13.9
C1910	4030017460	S.CER ECJ0EB1E102K	B	45.4/25.4
C1916	4030018960	S.CER C3216 JB 1C 106MT-N	B	14.7/50.5
C1917	4030018960	S.CER C3216 JB 1C 106MT-N	B	5.3/52.7
C1951	4030018960	S.CER C3216 JB 1C 106MT-N	B	48.1/103.1
C1952	4030018960	S.CER C3216 JB 1C 106MT-N	B	48.1/98.9
C1953	4030018960	S.CER C3216 JB 1C 106MT-N	B	48.1/96.8
C1954	4030018960	S.CER C3216 JB 1C 106MT-N	B	48.6/105.2
C1955	4030018960	S.CER C3216 JB 1C 106MT-N	B	48.1/101
C1956	4030018960	S.CER C3216 JB 1C 106MT-N	B	60.9/118.7
C1957	4030017330	S.CER ECJ0EF1C104Z	B	63.8/116.7
C1958	4030018910	S.CER C1608 JB 0J 475K-T	B	20.9/125.7
C1959	4550007090	S.TAN TEESVA 1A 226M8R	B	11.6/120.2
C1960	4030010210	S.CER C3216 JB 1C 105M-T	B	47.3/109.7
C1961	4030017730	S.CER ECJ0EB1E471K	B	44/110
C1962	4030017440	S.CER ECJ0EC1H221J	B	44.6/108.4
C1963	4030017500	S.CER ECJ0EC1H560J	B	35.3/105.1
C1964	4030017330	S.CER ECJ0EF1C104Z	B	44.3/111.3
C1965	4030018960	S.CER C3216 JB 1C 106MT-N	B	7.4/108
C1966	4030017330	S.CER ECJ0EF1C104Z	B	10.1/103
C1968	4030018960	S.CER C3216 JB 1C 106MT-N	B	31.7/103.6
C1969	4030018970	S.CER C3225 JB 1C 226MT-N	B	30.8/100.9
C1970	4030018970	S.CER C3225 JB 1C 226MT-N	B	30.8/97.9
C1971	4030017330	S.CER ECJ0EF1C104Z	B	45.9/111.3
C1972	4030017330	S.CER ECJ0EF1C104Z	B	47.6/106.7
C1973	4030017330	S.CER ECJ0EF1C104Z	B	32.1/105.1
C2001	4030017780	S.CER ECJ0EB1E472K	T	33.2/10.3
C2002	4030017330	S.CER ECJ0EF1C104Z	B	71.7/14.6
C2003	4030017780	S.CER ECJ0EB1E472K	B	58.8/15.8
C2004	4030017780	S.CER ECJ0EB1E472K	B	83/5.9
C2005	4030017780	S.CER ECJ0EB1E472K	B	69/16.4
C2006	4030017330	S.CER ECJ0EF1C104Z	B	83/6.8
C2007	4030017780	S.CER ECJ0EB1E472K	B	84.6/5.9
C2008	4030017330	S.CER ECJ0EF1C104Z	B	56.7/10.1
C2009	4030017330	S.CER ECJ0EF1C104Z	B	75.4/18.6
C2010	4030017780	S.CER ECJ0EB1E472K	B	75.6/6.6
C2011	4030017330	S.CER ECJ0EF1C104Z	B	75/7.7
C2012	4030017780	S.CER ECJ0EB1E472K	B	63.1/15.5
C2013	4030017330	S.CER ECJ0EF1		

[MAIN UNIT]

REF NO.	PARTS NO.	DESCRIPTION	M.	H/V LOCATION
C2016	4030017780	S.CER ECJ0EB1E472K	B	19/131.2
C2017	4030017330	S.CER ECJ0EF1C104Z	T	86.4/10.2
C2018	4030017780	S.CER ECJ0EB1E472K	B	42.7/17.7
C2019	4030017780	S.CER ECJ0EB1E472K	T	24.7/126.7
C2020	4030017330	S.CER ECJ0EF1C104Z	B	84.1/23.1
C2021	4030017780	S.CER ECJ0EB1E472K	B	32.5/16
C2022	4030017780	S.CER ECJ0EB1E472K	B	30.3/130.2
C2024	4030017780	S.CER ECJ0EB1E472K	B	28.7/128.2
C2025	4030017780	S.CER ECJ0EB1E472K	B	45/12.5
C2026	4030018960	S.CER C3216 JB 1C 106MT-N	B	10.1/23.4
C2027	4030018960	S.CER C3216 JB 1C 106MT-N	B	10.1/14.6
C2028	4030017330	S.CER ECJ0EF1C104Z	B	51.7/12.7
C2029	4030017330	S.CER ECJ0EF1C104Z	B	58.1/9.4
C2030	4030017330	S.CER ECJ0EF1C104Z	B	55.8/15.8
C2032	4030017780	S.CER ECJ0EB1E472K	B	27.4/129
C2033	4030017330	S.CER ECJ0EF1C104Z	B	71.1/21.9
C2034	4030017780	S.CER ECJ0EB1E472K	B	64.8/5.6
C2035	4030017780	S.CER ECJ0EB1E472K	B	25.6/130.2
C2036	4030017330	S.CER ECJ0EF1C104Z	B	88.2/8
C2037	4030017330	S.CER ECJ0EF1C104Z	B	76.4/16.5
C2038	4030017780	S.CER ECJ0EB1E472K	T	14.5/126.4
C2039	4030017780	S.CER ECJ0EB1E472K	B	80.2/6.7
C2040	4030017780	S.CER ECJ0EB1E472K	B	64.6/17.7
C2041	4030017330	S.CER ECJ0EF1C104Z	B	75.2/10.5
C2042	4030017330	S.CER ECJ0EF1C104Z	B	62.7/18.1
C2043	4030017780	S.CER ECJ0EB1E472K	B	55.4/8.8
C2044	4030017780	S.CER ECJ0EB1E472K	B	62.7/19.5
C2045	4030017780	S.CER ECJ0EB1E472K	B	64.3/21.8
C2046	4030017780	S.CER ECJ0EB1E472K	B	63.6/14.6
C2047	4030017780	S.CER ECJ0EB1E472K	B	57.7/21.9
C2048	4030017780	S.CER ECJ0EB1E472K	B	63.1/5.6
C2049	4030017780	S.CER ECJ0EB1E472K	T	45.1/101.8
C2050	4030017780	S.CER ECJ0EB1E472K	T	42.8/100.3
C2051	4030017330	S.CER ECJ0EF1C104Z	T	56.3/99.9
C2052	4030017780	S.CER ECJ0EB1E472K	T	21.6/108
C2053	4030017780	S.CER ECJ0EB1E472K	T	49.8/107.5
C2054	4030018960	S.CER C3216 JB 1C 106MT-N	B	55.3/83.4
C2055	4030018960	S.CER C3216 JB 1C 106MT-N	B	28.1/88.5
C2058	4030018960	S.CER C3216 JB 1C 106MT-N	B	16.4/95.5
C2062	4550007710	S.TAN TEESVB2 1A 476M8R	B	26.6/13
C2063	4030017730	S.CER ECJ0EB1E471K	B	46/13.7
C2064	4030018960	S.CER C3216 JB 1C 106MT-N	B	61.1/23
C2065	4030016930	S.CER ECJ0EB1A104K	B	73.3/1.2
C2066	4030016930	S.CER ECJ0EB1A104K	B	75.1/1.2
C2067	4030017430	S.CER ECJ0EC1H101J	B	56.9/19.9
C2068	4030017460	S.CER ECJ0EB1E102K	B	59.1/26.1
C2069	4030017730	S.CER ECJ0EB1E471K	B	46.6/12.1
C2101	4030017330	S.CER ECJ0EF1C104Z	T	28.3/113.8
C2102	4030017330	S.CER ECJ0EF1C104Z	T	44.7/110.9
C2103	4030018960	S.CER C3216 JB 1C 106MT-N	T	28.8/112.2
C2104	4030017330	S.CER ECJ0EF1C104Z	T	56.1/123.5
C2105	4030018960	S.CER C3216 JB 1C 106MT-N	T	54.7/125
C2156	4030017330	S.CER ECJ0EF1C104Z	T	36.2/122.1
C2157	4030017330	S.CER ECJ0EF1C104Z	B	34.4/91
C2158	4030017330	S.CER ECJ0EF1C104Z	B	27.4/93.7
C2159	4030017330	S.CER ECJ0EF1C104Z	T	22.4/94.4
C2160	4030017330	S.CER ECJ0EF1C104Z	B	38.2/88.8
C2161	4030018960	S.CER C3216 JB 1C 106MT-N	T	36.8/123.6
C2162	4030018960	S.CER C3216 JB 1C 106MT-N	B	37.7/90.4
C2163	4030017780	S.CER ECJ0EB1E472K	T	4.6/116.5
C2164	4030018960	S.CER C3216 JB 1C 106MT-N	T	6.5/114.9
C2166	4030012610	S.CER C2012 JB 1C 474K-T	T	5.2/106.8
C2167	4030018960	S.CER C3216 JB 1C 106MT-N	T	4.9/109.9
C2168	4030012610	S.CER C2012 JB 1C 474K-T	T	16.5/116.8
C2169	4030016930	S.CER ECJ0EB1A104K	T	14/124.2
C2201	4030017780	S.CER ECJ0EB1E472K	T	24.7/125.8
C2203	4030018520	S.CER C1608 JB 0J 225M-T	T	16/118.4
C2204	4030017330	S.CER ECJ0EF1C104Z	T	11.1/119.7
C2205	4030018960	S.CER C3216 JB 1C 106MT-N	T	12.4/117.1
C2206	4030017780	S.CER ECJ0EB1E472K	T	21.7/115.6
C2208	4030017730	S.CER ECJ0EB1E471K	T	19/116.9
C2211	4030018960	S.CER C3216 JB 1C 106MT-N	T	22.4/119.9
C2212	4030018960	S.CER C3216 JB 1C 106MT-N	T	23.2/124.3
C2213	4550007140	S.TAN TEESVD 1C 107M12R	T	37.6/138.5
C2214	4030018910	S.CER C1608 JB 0J 475K-T	T	20.9/122.6
C2231	4030017330	S.CER ECJ0EF1C104Z	T	38.2/105.6
C2232	4030018960	S.CER C3216 JB 1C 106MT-N	T	38.1/104
C2233	4030017780	S.CER ECJ0EB1E472K	T	4.7/123.2
C2234	4550007310	S.TAN F930J227MNMBA	T	70.1/130.6
C2235	4030018960	S.CER C3216 JB 1C 106MT-N	T	40.9/108.8
C2236	4030018960	S.CER C3216 JB 1C 106MT-N	T	39.8/111.1
C2237	4030017460	S.CER ECJ0EB1E102K	T	60.6/123.3
C2254	4030017330	S.CER ECJ0EF1C104Z	T	7.6/92.5
C2255	4030017330	S.CER ECJ0EF1C104Z	B	2.4/98.1
C2256	4030017330	S.CER ECJ0EF1C104Z	B	2.6/95.6
C2257	4030017330	S.CER ECJ0EF1C104Z	T	9.9/87.9
C2260	4030017330	S.CER ECJ0EF1C104Z	T	18.5/103.6
C2261	4030017330	S.CER ECJ0EF1C104Z	T	6.7/104.4
C2262	4030017330	S.CER ECJ0EF1C104Z	T	58.5/100.3
C2264	4030017330	S.CER ECJ0EF1C104Z	T	61.8/88.9
C2266	4030017330	S.CER ECJ0EF1C104Z	T	72/85.2
C2268	4030017330	S.CER ECJ0EF1C104Z	T	68.5/89.4
C2269	4030017330	S.CER ECJ0EF1C104Z	B	78.4/92.4
C2270	4030017780	S.CER ECJ0EB1E472K	T	61.8/89.8
C2272	4030017330	S.CER ECJ0EF1C104Z	T	56.2/92.2
C2274	4030017330	S.CER ECJ0EF1C104Z	T	55.8/95
C2275	4030017330	S.CER ECJ0EF1C104Z	B	68.1/99.3
C2276	4030017330	S.CER ECJ0EF1C104Z	B	64.2/100.6

[MAIN UNIT]

REF NO.	PARTS NO.	DESCRIPTION	M.	H/V LOCATION
C2277	4030017330	S.CER ECJ0EF1C104Z	T	63.6/103.4
C2278	4030017330	S.CER ECJ0EF1C104Z	T	63.6/107.9
C2279	4030017330	S.CER ECJ0EF1C104Z	T	62.7/108.8
C2280	4030017420	S.CER ECJ0EC1H470J	T	51.8/37.9
C2281	4030017330	S.CER ECJ0EF1C104Z	T	68.5/90.3
C2282	4030017330	S.CER ECJ0EF1C104Z	B	80.4/93
C2283	4030017330	S.CER ECJ0EF1C104Z	B	81.6/92.1
C2285	4030017330	S.CER ECJ0EF1C104Z	T	50.8/99.9
C2286	4030017330	S.CER ECJ0EF1C104Z	T	14.1/88.8
C2301	4030018910	S.CER C1608 JB 0J 475K-T	T	30.8/106.9
C2302	4030018910	S.CER C1608 JB 0J 475K-T	T	27.8/109.4
C2303	4550007310	S.TAN F930J227MNMBA	T	84.4/110.3
C2311	4030017330	S.CER ECJ0EF1C104Z	B	68.1/110.2
C2312	4030018910	S.CER C1608 JB 0J 475K-T	B	67.3/104.9
C2401	4030017330	S.CER ECJ0EF1C104Z	B	90.8/103.8
C2402	4030017330	S.CER ECJ0EF1C104Z	B	81.2/100.7
C2403	4030017780	S.CER ECJ0EB1E472K	B	77.2/28.8
C2405	4030017330	S.CER ECJ0EF1C104Z	T	74.2/79.3
C2406	4030017460	S.CER ECJ0EB1E102K	B	88.5/99.7
C2407	4030017330	S.CER ECJ0EF1C104Z	T	74.1/78.2
C2408	4030017330	S.CER ECJ0EF1C104Z	B	84.9/96.1
C2409	4030017330	S.CER ECJ0EF1C104Z	T	75.6/77.6
C2410	4030017330	S.CER ECJ0EF1C104Z	B	88.5/85.8
C2411	4030017330	S.CER ECJ0EF1C104Z	B	81.1/96.4
C2412	4510008630	S.ELE 16 CE 47 FE	B	62.1/30.4
C2413	4030017330	S.CER ECJ0EF1C104Z	B	88.5/93.7
C2414	4030017780	S.CER ECJ0EB1E472K	T	84/95.6
C2415	4030017780	S.CER ECJ0EB1E472K	B	88.3/28
C2417	4030017330	S.CER ECJ0EF1C104Z	B	88.3/27.1
C2418	4030017330	S.CER ECJ0EF1C104Z	B	82.6/94
C2419	4030017330	S.CER ECJ0EF1C104Z	B	88.5/86.7
C2422	4030017330	S.CER ECJ0EF1C104Z	T	84.8/87.3
C2423	4030017420	S.CER ECJ0EC1H470J	B	62.1/141.2
C2424	4510008630	S.ELE 16 CE 47 FE	B	69.2/31.3
C2426	4030017330	S.CER ECJ0EF1C104Z	B	68.8/82.1
C2427	4030012600	S.CER C2012 JB 1A 105M-T	T	85.1/91.4
C2501	4030017330	S.CER ECJ0EF1C104Z	B	8/94.2
C2502	4030018960	S.CER C3216 JB 1C 106MT-N	B	11.5/95.2
C2503	4030016970	S.CER ECJ0EB1C223K	B	14.9/89.3
C2505	4030016940	S.CER ECJ0EB1A393K	B	17.4/91.4
C2506	4030017780	S.CER ECJ0EB1E472K	B	18.2/93.8
C2507	4030017490	S.CER C1608 JB 1A 105K-T	B	12.7/89.2
C2551	4030017330	S.CER ECJ0EF1C104Z	B	42.9/124.1
C2552	4030018960	S.CER C3216 JB 1C 106MT-N	B	47.8/118.8
C2553	4030016970	S.CER ECJ0EB1C223K	B	51.3/124.7
C2554	4030018390	S.CER ECJ0EB1A563K	B	53.9/121.9
C2555	4030017760	S.CER ECJ0EB1H222K	B	53.9/121
C2556	4030017770	S.CER ECJ0EB1E332K	B	52.8/123.8
C2557	4030017330	S.CER ECJ0EF1C104Z	B	41.7/120.8
C2558	4030018960	S.CER C3216 JB 1C 106MT-N	B	42.9/118.4
C2561	4030018960	S.CER C3216 JB 1C 106MT-N	B	56.5/124.3
C2562	4030018960	S.CER C3216 JB 1C 106MT-N	B	53.4/126.4
C2563	4550007970	S.TAN TMCMC1A107MTRF	B	75.3/122.8
C2564	4030018080	S.CER ECJ0EB1H182K	B	47.8/125.6
C2565	4030017430	S.CER ECJ0EC1H101J	B	44.6/122.6
C2566	4030018090	S.CER ECJ0EB1C822K	B	46.2/124.3
C2601	4030017330	S.CER ECJ0EF1C104Z	B	59.7/125.1
C2603	4030010210	S.CER C3216 JB 1C 105M-T	B	87.5/126
C2604	4030016970	S.CER ECJ0EB1C223K	B	89.1/128.6
C2605	4030017330	S.CER ECJ0EF1C104Z	B	83.9/133.7
C2606	4510009250	S.ELE EEEFK1C471P	T	69.2/137.4
C2607	4510008650	S.ELE EEEFK1C221P	T	58.5/138.3
C2608	4030017330	S.CER ECJ0EF1C104Z	B	87.5/128.6
C2610	4510009250	S.ELE EEEFK1C471P	T	6.2/65.3
C2612	4030017330	S.CER ECJ0EF1C104Z	B	33.9/123.9
C2613	4510009250	S.ELE EEEFK1C471P	T	31.7/131.5
C2616	4030017780	S.CER ECJ0EB1E472K	B	31.6/134.3
C2617	4030017780	S.CER ECJ0EB1E472K	T	33.5/126
C2618	4030017430	S.CER ECJ0EC1H101J	B	31.6/134.3
C2619	4030017780	S.CER ECJ0EB1E472K	T	67.7/112.6
C2620	4510008630	S.ELE 16 CE 47 FE	B	82.9/119.1
C2621	4510008500	S.ELE EEE1CA101WP	T	49.2/138.3
C2622	4510008500	S.ELE EEE1CA101WP	T	60.1/130.4
C2624	4030017330	S.CER ECJ0EF1C104Z	B	38.4/124.5
CP1601	6910009670	S.CHE HK3-S-T	T	11.7/54.7
J1	6510007020	CON TMP-J01X-V6		
J101	6510007020	CON TMP-J01X-V6		
J401	6510007020	CON TMP-J01X-V6		
J801	6510007020	CON TMP-J01X-V6		
J2002	6510019971	S.CON 52808-1071	T	39/12.6
J2003	6510024861	S.CON 5406721-2	T	18.7/137.8
J2004	6510023511	S.CON 28FLT-SM2-TB(LF)(SN)	T	82.4/4.9
J2005	6510023511	S.CON 28FLT-SM2-TB(LF)(SN)	T	66/4.9
J2231	6510018961	S.CON B2B-PH-SM4-TB(LF)(SN)	T	51.6/129.5
J2251	6510022881	S.CON AXK5S30347YG	T	12.3/96.6
J2252	6510024821	S.CON AXK5S60347YG	T	72.4/101.7
J24				

[MAIN UNIT]

REF NO.	PARTS NO.	DESCRIPTION	M.	H/V LOCATION
EP511	6910012350	S.BEA MMZ1608Y 102BT	T	44.1/26.5
EP1951	6910014730	S.BEA MPZ2012S331A-T	B	61.3/116.7
EP1952	6910014730	S.BEA MPZ2012S331A-T	B	26.8/113.3
EP1953	6910014730	S.BEA MPZ2012S331A-T	B	9.9/104.5
EP1954	6910014730	S.BEA MPZ2012S331A-T	B	50.3/107.3
EP2001	6910012350	S.BEA MMZ1608Y 102BT	B	74.2/5.3
EP2002	6910012350	S.BEA MMZ1608Y 102BT	B	34.7/12.6
EP2003	6910012350	S.BEA MMZ1608Y 102BT	B	33.5/13.8
EP2004	6910012350	S.BEA MMZ1608Y 102BT	B	39.5/15.9
EP2006	6910014730	S.BEA MPZ2012S331A-T	B	42.2/13.3
EP2007	6910012350	S.BEA MMZ1608Y 102BT	B	45.2/11
EP2008	6910012350	S.BEA MMZ1608Y 102BT	B	45.1/14.8
EP2231	6910012350	S.BEA MMZ1608Y 102BT	T	59.8/125.7
EP2251	6910012350	S.BEA MMZ1608Y 102BT	T	4.5/95.5
EP2252	6910012350	S.BEA MMZ1608Y 102BT	T	7.5/95.8
EP2253	6910012350	S.BEA MMZ1608Y 102BT	T	66.1/109.3
EP2254	6910012350	S.BEA MMZ1608Y 102BT	T	65.7/108.1
EP2255	6910012350	S.BEA MMZ1608Y 102BT	T	17.8/101.5
EP2256	6910012350	S.BEA MMZ1608Y 102BT	T	65.1/106
EP2257	6910012350	S.BEA MMZ1608Y 102BT	T	65.1/104.8
EP2258	6910012350	S.BEA MMZ1608Y 102BT	B	77.9/93.4
EP2259	6910012350	S.BEA MMZ1608Y 102BT	B	68.1/102.5
EP2260	6910012350	S.BEA MMZ1608Y 102BT	B	68.1/101.3
EP2261	6910012350	S.BEA MMZ1608Y 102BT	B	66/98.2
EP2262	6910012350	S.BEA MMZ1608Y 102BT	T	69.9/85.5
EP2263	6910014730	S.BEA MPZ2012S331A-T	T	6.5/93.9
EP2264	6910012350	S.BEA MMZ1608Y 102BT	B	69.3/111.3
EP2265	6910012350	S.BEA MMZ1608Y 102BT	B	68.6/98.2
EP2266	6910012350	S.BEA MMZ1608Y 102BT	T	56.2/93.3
EP2271	6910012350	S.BEA MMZ1608Y 102BT	T	74.6/91.1
EP2402	6910012350	S.BEA MMZ1608Y 102BT	B	51.1/129.6
EP2403	6910012350	S.BEA MMZ1608Y 102BT	B	48.4/129.6
EP2404	6910012350	S.BEA MMZ1608Y 102BT	B	68.5/129.3
EP2405	6910012350	S.BEA MMZ1608Y 102BT	B	62.1/134.9
EP2408	6910012350	S.BEA MMZ1608Y 102BT	B	91.3/102.7
EP2409	6910012350	S.BEA MMZ1608Y 102BT	T	85.3/101.2
EP2410	6910012350	S.BEA MMZ1608Y 102BT	T	84.7/98.3
EP2411	6910012350	S.BEA MMZ1608Y 102BT	T	85.2/79.2
EP2412	6910012350	S.BEA MMZ1608Y 102BT	T	82.5/78.4
EP2413	6910012350	S.BEA MMZ1608Y 102BT	B	72.4/129.3
EP2414	6910012350	S.BEA MMZ1608Y 102BT	B	89.3/91
EP2415	6910012350	S.BEA MMZ1608Y 102BT	T	84.9/100
EP2416	6910012350	S.BEA MMZ1608Y 102BT	T	80/77.6
EP2417	6910012350	S.BEA MMZ1608Y 102BT	B	87.2/78.8
EP2602	6910014730	S.BEA MPZ2012S331A-T	T	35.9/125.6
EP2604	6910014730	S.BEA MPZ2012S331A-T	B	31.6/135.7
EP2605	6910014730	S.BEA MPZ2012S331A-T	T	42.9/135.4
EP2606	6910014730	S.BEA MPZ2012S331A-T	T	41.3/133.7
MP201	8510017210	PLA 2427 B-SHIELD PLATE Y801	B	23.1/59.8

[PA UNIT]

REF NO.	PARTS NO.	DESCRIPTION	M.	H/V LOCATION
IC471	1110005630	S.IC UPC3215TB-E3-A	B	67.6/96.4
IC701	1180002010	S.REG BA08FP-E2	B	126.3/41.9
IC960	1110002700	S.IC NJM2904M-TE1-#FMZB	B	41/132.1
IC981	1130012720	S.IC CD74HC4094PWR	T	26.2/5.9
Q101	1560001091	S.FET 2SK2854(T2LICOM,F)	T	149.2/28.5
Q102	1560001241	S.FET RD01MUS1-T113	T	146/40.1
Q301	1560001391	FET RD70HHF1-101		
Q302	1560001391	FET RD70HHF1-101		
Q401	1560001611	FET RD60HUF1C-101		
Q402	1590000680	S.TRA DTC114EUA T106	B	87.7/132.8
Q403	1590000680	S.TRA DTC114EUA T106	B	90/130.3
Q451	1580000691	S.FET 3SK291(TE85R,F)	B	76.7/108.3
Q452	1590003940	S.TRA RN1105(TE85L,F)	B	67.5/115.8
Q453	1590003940	S.TRA RN1105(TE85L,F)	B	75.1/119.8
Q501	1560001591	FET RD70HVF1C-121		
Q502	1590000680	S.TRA DTC114EUA T106	T	87.7/107.5
Q503	1590000680	S.TRA DTC114EUA T106	T	87.7/110
Q551	1580000691	S.FET 3SK291(TE85R,F)	T	68.4/108.9
Q552	1590003940	S.TRA RN1105(TE85L,F)	T	63/110.1
Q700	1590003940	S.TRA RN1105(TE85L,F)	B	126.4/25
Q741	1590003940	S.TRA RN1105(TE85L,F)	B	79.4/9
Q742	1520000460	S.TRA 2SB1132 T100 R	B	83.6/8.2
Q980	1590003940	S.TRA RN1105(TE85L,F)	T	51.3/84.6
Q981	1590003940	S.TRA RN1105(TE85L,F)	T	51.5/13.8
Q982	1590003940	S.TRA RN1105(TE85L,F)	T	53.8/97.3
Q983	1590003940	S.TRA RN1105(TE85L,F)	T	51.2/56.9
Q984	1590003940	S.TRA RN1105(TE85L,F)	T	51.6/97.2
Q985	1590003940	S.TRA RN1105(TE85L,F)	T	51.3/27.9
Q986	1590003940	S.TRA RN1105(TE85L,F)	T	51.3/71.4
Q987	1590003940	S.TRA RN1105(TE85L,F)	T	52.5/41.6
Q988	1590003930	S.TRA UMD22N TR	T	58.2/90.2
D101	1750000301	S.DIO 1SS302(TE85R,F)	T	152.4/22.7
D102	1750000301	S.DIO 1SS302(TE85R,F)	T	152.4/19.8
D151	1750000581	S.DIO 1SV307(TPH3,F)	T	59.5/56.4
D152	1790001251	S.DIO MA2S1110GL	T	56.3/58.5
D301	1160000060	S.DIO DAN202U T106	T	105.1/80.8
D302	1160000060	S.DIO DAN202U T106	T	74.9/87.3
D401	1790001241	S.DIO MA2S7280GL	B	128/133.6
D402	1790001241	S.DIO MA2S7280GL	B	127.5/139.5
D403	1790001241	S.DIO MA2S7280GL	B	123.4/140.5
D404	1790001241	S.DIO MA2S7280GL	B	125.6/132.8
D406	1710001061	DIO L407CDB		
D407	1710001061	DIO L407CDB		
D408	1750000511	S.DIO UX9401F-STD/TR <INT>	B	97.7/136.4
D409	1750000511	S.DIO UX9401F-STD/TR <INT>	B	103.5/133
D410	1750000511	S.DIO UX9401F-STD/TR <INT>	B	104.7/130
D411	1790001251	S.DIO MA2S1110GL	B	94.2/129.2
D412	1160000070	S.DIO DAN202K T146	B	91.6/127
D451	1750000581	S.DIO 1SV307(TPH3,F)	B	85.5/116.3
D452	1750000581	S.DIO 1SV307(TPH3,F)	B	82.4/116
D453	1720000701	S.VAR 1SV305(TPL3,F)	T	75.5/117.3
D454	1720000701	S.VAR 1SV305(TPL3,F)	T	77.8/116.6
D455	1720000701	S.VAR 1SV305(TPL3,F)	B	75.6/99.1
D456	1720000701	S.VAR 1SV305(TPL3,F)	B	67.3/104.1
D461	1750000581	S.DIO 1SV307(TPH3,F)	B	65/93.5
D462	1750000581	S.DIO 1SV307(TPH3,F)	T	65.6/94.7
D501	1790000971	S.DIO MA2J7290GL	B	113.7/123.4
D502	1790000971	S.DIO MA2J7290GL	B	116.3/122.8
D503	1790000971	S.DIO MA2J7290GL	B	114.5/129.4
D504	1790000971	S.DIO MA2J7290GL	B	111/129.4
D506	1710001061	DIO L407CDB		
D507	1750000511	S.DIO UX9401F-STD/TR <INT>	B	92.1/117.4
D508	1750000511	S.DIO UX9401F-STD/TR <INT>	T	86.9/114.4
D509	1750000511	S.DIO UX9401F-STD/TR <INT>	T	81.9/120.3
D510	1710001061	DIO L407CDB		
D511	1750000581	S.DIO 1SV307(TPH3,F)	B	95.3/112.2
D551	1750000581	S.DIO 1SV307(TPH3,F)	T	74/116.7
D552	1750000581	S.DIO 1SV307(TPH3,F)	T	72.2/116.7
D553	1750000610	S.VAR MA2SV0500L	T	67.2/118.5
D554	1750000610	S.VAR MA2SV0500L	T	69.6/117.8
D555	1750000581	S.DIO 1SV307(TPH3,F)	T	66.9/116.7
D556	1720000590	S.VAR MA357(TX)	T	71.6/113.3
D557	1750000581	S.DIO 1SV307(TPH3,F)	T	68.1/104.9
D558	1720000590	S.VAR MA357(TX)	T	72.2/104.3
D559	1750000610	S.VAR MA2SV0500L	T	68.9/102.7
D560	1750000610	S.VAR MA2SV0500L	T	71.7/101.3
D701	1790000700	DIO DSA3A1		
D702	1790000700	DIO DSA3A1		
D703	1160000070	S.DIO DAN202K T146	B	126.5/21.5
D704	1790001241	S.DIO MA2S7280GL	B	87.9/113.9
D705	1160000070	S.DIO DAN202K T146	B	137.5/14.2
D706	1790001241	S.DIO MA2S7280GL	B	86/113
D801	1750000301	S.DIO 1SS302(TE85R,F)	B	42.7/41.8
D820	1750000301	S.DIO 1SS302(TE85R,F)	B	54.3/94.5
D840	1750000301	S.DIO 1SS302(TE85R,F)	B	43.3/99.8
D860	1750000301	S.DIO 1SS302(TE85R,F)	B	43/86
D880	1750000301	S.DIO 1SS302(TE85R,F)	B	43.3/71.6
D900	1750000301	S.DIO 1SS302(TE85R,F)	B	43.7/56.9
D920	1750000301	S.DIO 1SS302(TE85R,F)	B	42.9/28
D940	1750000301	S.DIO 1SS302(TE85R,F)	B	41.1/14.2
D961	1790000491	S.DIO HSM88ASTR-E	B	28.1/130.2
D962	1790000491	S.DIO HSM88ASTR-E	B	28.1/133.7
D964	1750000511	S.DIO UX9401F-STD/TR <INT>	B	40.1/43.9
D965	1750000511	S.DIO UX9401F-STD/TR <INT>	B	42.8/48

M.=Mounted side (T: Mounted on the Top side, B: Mounted on the Bottom side)
S.=Surface mount

[PA UNIT]

REF NO.	PARTS NO.	DESCRIPTION	M.	H/V LOCATION
L101	6200005051	S.COI NLV25T-330J	T	151.3/33.6
L102	6200008570	S.COI LQW2BHN6N8D03L	T	152.3/37.3
L103	6180000990	COI LAL 04NA 101K		
L104	6180000990	COI LAL 04NA 101K		
L105	6200003950	S.COI HF50ACC 322513-T	B	135.7/34.1
L107	6200002631	S.COI NLV25T-R10J	T	141/47.9
L108	6200003031	S.COI NLV32T-R47J	B	138/41.7
L151	6200003941	S.COI NLV25T-5R6J	B	64.1/41
L152	6200005521	S.COI NLV25T-470J	B	64.8/38
L201	6140004580	S.COI LR-515	T	150.4/52.5
L203	6200010040	S.COI AS100340-10N	T	113.8/79.5
L204	6200010040	S.COI AS100340-10N	T	123.5/69.7
L301	6140003410	COI LR-383		
L302	2040000490	COI EXC-ELDR25C		
L303	6140003590	COI LR-400 (TR10X5X5 6H3)		
L304	6140004570	COI LR-507		
L305	6140004560	COI LR-506		
L404	6200010060	S.COI AS080647-56N	T	141/108.9
L407	6200010170	S.COI AS080447-33N	T	146.6/110.7
L408	2040000490	COI EXC-ELDR25C		
L409	2040000490	COI EXC-ELDR25C		
L410	6200010040	S.COI AS100340-10N	T	126.5/137.8
L411	6200010420	S.COI FHW1210HC 1R0JGT <JJE>	T	118.3/136.7
L412	6200010160	S.COI AS080440-22N	T	104.4/134.4
L413	6200010150	S.COI AS080340-15N	T	88.2/139.5
L414	6200010150	S.COI AS080340-15N	T	81/133.5
L415	6200012960	S.COI 0.45-1.4-4TL 12.1N <COMO>	T	99.2/134
L416	6200013000	S.COI 0.25-1.9-13TL 135N <COMO>	T	93.8/132.1
L417	6200007790	S.COI LQW2BHN1R15J03L	B	98.3/131.1
L441	6200010040	S.COI AS100340-10N	T	133.4/137.8
L451	6200005621	S.COI ELJRE 4N7ZFA	B	81.5/120.1
L452	6200012660	S.COI 0.30-1.0-4TR 9.1N <COMO>	T	76.7/114.9
L453	6200007230	S.COI LQW2BHN15N03L	B	74/104
L454	6200007230	S.COI LQW2BHN15N03L	B	69.9/102.3
L501	6200010780	S.COI C2520C-1R0G-A	T	117.1/86.6
L502	6200010060	S.COI AS080647-56N	T	118.1/125
L504	6200010780	S.COI C2520C-1R0G-A	T	105.7/123.4
L505	6200010070	S.COI AS080747-68N	T	90.2/118.5
L506	6200010170	S.COI AS080447-33N	T	91.9/124.3
L507	6200012910	S.COI 0.35-1.6-8TL 45.5N <COMO>	T	84.7/1118
L508	6200010050	S.COI AS080547-47N	T	81.8/127.7
L509	6200010780	S.COI C2520C-1R0G-A	T	93.2/113.1
L510	6200010050	S.COI AS080547-47N	T	75.5/127.5
L531	6110003980	COI LA-604		
L541	6200010070	S.COI AS080747-68N	T	128.5/129.8
L551	6200007700	S.COI LQW2BHN22N03L	T	76.1/120.8
L552	6200007720	S.COI LQW2BHN33N03L	T	70.8/121.2
L553	6200008090	S.COI LQW2BHN68N03L	T	65.1/121.6
L554	6200003640	S.COI MLF1608E 100K-T	T	64.9/114.8
L555	6200003711	S.COI NLV25T-2R7J	B	65.2/105.4
L556	6200003640	S.COI MLF1608E 100K-T	B	64.9/109.6
L557	6200007760	S.COI LQW2BHN82N03L	T	66.8/100.5
L558	6200007710	S.COI LQW2BHN27N03L	T	69.9/98.3
L560	6200002611	S.COI NLV25T-R47J	T	62.9/97.3
L601	6200010040	S.COI AS100340-10N	T	69.2/127.5
L602	6200010160	S.COI AS080440-22N	T	65.7/132.8
L603	6200010150	S.COI AS080340-15N	T	60.8/133.5
L705	6200003550	S.COI MLF1608A 4R7K-T	B	68.2/10.3
L706	6200011300	S.COI EXCML16A270U	T	91/6.9
L707	6200011300	S.COI EXCML16A270U	T	91/5.6
L801	6200011410	S.COI C2520C-82NG-A	T	55.8/55.5
L802	6200010650	S.COI C2520C-R12G-A (0.12U)	T	58.5/52.1
L803	6200007420	S.COI ELJFC 101K-F	B	50.4/39.8
L820	6200006430	S.COI ELJFC 180K-F	B	52.8/97.3
L821	6140002020	COI LR-229 (T50-10)		
L822	6140003540	COI LR-396		
L823	6200006430	S.COI ELJFC 180K-F	B	2.7/106.8
L840	6200007420	S.COI ELJFC 101K-F	B	49.2/98.5
L841	6140001820	COI LR-218 (T50-10)		
L842	6140001800	COI LR-216 (T50-2)		
L843	6140001800	COI LR-216 (T50-2)		
L844	6200007420	S.COI ELJFC 101K-F	B	2.6/90.7
L860	6200004440	S.COI ELJFC 4R7M-F	B	50.3/83.8
L861	6110003550	COI LA-547 (LA-214A)		
L862	6110003570	COI LA-550		
L863	6110003540	COI LA-548 (LA-215A)		
L864	6200004440	S.COI ELJFC 4R7M-F	B	2.8/74.5
L880	6200007420	S.COI ELJFC 101K-F	B	50.3/69.1
L881	6140002570	COI LR-294 (T50-2)		
L882	6140002580	COI LR-295 (T50-2)		
L883	6200007420	S.COI ELJFC 101K-F	B	2.6/58.4
L900	6200008600	S.COI ELJFC 560K-F	B	50/54.6
L901	6140002560	COI LR-293 (T50-10)		
L902	6140002560	COI LR-293 (T50-10)		
L903	6140002560	COI LR-293 (T50-10)		
L904	6200008600	S.COI ELJFC 560K-F	B	2.6/42.3
L920	6200007420	S.COI ELJFC 101K-F	B	50.4/25.4
L921	6140001780	COI LR-214 (T50-2)		
L922	6140001780	COI LR-214 (T50-2)		
L923	6200007420	S.COI ELJFC 101K-F	B	2.6/26.1
L940	6200007390	S.COI ELJFC 120K-F	B	47.3/9.9
L941	6140003450	COI LR-387 (T50-10)		
L942	6140003460	COI LR-388 (T50-10)		
L943	6200007420	S.COI ELJFC 101K-F	B	41.1/11.1
L944	6200007390	S.COI ELJFC 120K-F	B	9/10.5
L960	6200007420	S.COI ELJFC 101K-F	B	45.3/130.6
L961	6140003490	COI LR-391 (TR10X5X5 3A6)		
L980	6200007420	S.COI ELJFC 101K-F	B	30.7/8

[PA UNIT]

REF NO.	PARTS NO.	DESCRIPTION	M.	H/V LOCATION
L981	6200007420	S.COI ELJFC 101K-F	T	51.7/9
L982	6200007420	S.COI ELJFC 101K-F	T	48.3/2.3
R101	7030003370	S.RES ERJ3GEYJ 271 V (270)	B	150.9/21
R102	7030003230	S.RES ERJ3GEYJ 180 V (18)	B	150.9/22.5
R103	7030003370	S.RES ERJ3GEYJ 271 V (270)	B	151.9/25.2
R104	7030003300	S.RES ERJ3GEYJ 680 V (68)	B	150.8/27.7
R105	7030003420	S.RES ERJ3GEYJ 681 V (680)	T	152.7/29.8
R106	7030003480	S.RES ERJ3GEYJ 222 V (2.2K)	B	147.8/29.7
R107	7030003530	S.RES ERJ3GEYJ 562 V (5.6K)	B	147.8/28.3
R108	7030003400	S.RES ERJ3GEYJ 471 V (470)	T	151.4/31.7
R109	7030008190	S.RES ERJ12YJ330U (33)	B	145.5/32.7
R110	7030000230	S.RES MCR10EZJH 56 (560)	T	149.4/39.8
R111	7030003410	S.RES ERJ3GEYJ 561 V (560)	B	143.8/42.1
R112	7030003510	S.RES ERJ3GEYJ 392 V (3.9K)	B	146.1/37.5
R113	7030003540	S.RES ERJ3GEYJ 682 V (6.8K)	B	146.1/35.7
R116	7030000340	S.RES MCR10EZJH 470 (471)	B	141.3/40.8
R117	7030003860	S.RES ERJ3GE JPW V	T	146.7/47.7
R151	7030003380	S.RES ERJ3GEYJ 331 V (330)	B	61.6/37.8
R152	7030003440	S.RES ERJ3GEYJ 102 V (1K)	B	61.7/60.1
R153	7030003520	S.RES ERJ3GEYJ 472 V (4.7K)	T	59.2/57.9
R201	7030003320	S.RES ERJ3GEYJ 101 V (100)	B	126/49.8
R202	7030003520	S.RES ERJ3GEYJ 472 V (4.7K)	B	138/49.8
R204	7030003440	S.RES ERJ3GEYJ 102 V (1K)	B	138/52.8
R205	70300010420	S.RES ERJ1TYJ 560U (56)	B	145/51.5
R301	7030009300	S.RES ERJ1WY0R00U	B	92.2/84.4
R302	7030010520	S.RES ERJ1TYJ 101U (100)	T	89.4/86.1
R303	7030009300	S.RES ERJ1WY0R00U	B	85.4/84.4
R304	7030003320	S.RES ERJ3GEYJ 101 V (100)	T	107.1/79.8
R305	7030010410	S.RES ERJ1TYJ 220U (22)	T	100.2/84.1
R306	7030003320	S.RES ERJ3GEYJ 101 V (100)	B	71.2/83.3
R307	7030010410	S.RES ERJ1TYJ 220U (22)	T	77.5/84.1
R308	7030003480	S.RES ERJ3GEYJ 222 V (2.2K)	B	99/84.9
R309	7030003480	S.RES ERJ3GEYJ 222 V (2.2K)	B	78.7/84.9
R310	7030007630	S.RES MCR100ZJH 0.68 (R68)	B	100.1/82.2
R311	7030007630	S.RES MCR100ZJH 0.68 (R68)	B	78.3/82.1
R312	7030011250	S.RES ERJ1TY 390U (39)	T	100.9/77.7
R313	7030010540	S.RES ERJ1TYJ 330U (33)	T	97.2/77.7
R314	7030010540	S.RES ERJ1TYJ 330U (33)	T	81.6/77.7
R315	7030011250	S.RES ERJ1TY 390U (39)	T	77.9/77.7
R317	7030010950	S.RES ERJ1TYJ 100U (10)	B	104/20.6
R318	7030010950	S.RES ERJ1TYJ 100U (10)	B	99.6/20.6
R319	7030010660	S.RES ERJ1TYJ 6R8U (6.8)	B	89.4/54.5
R402	7030003320	S.RES ERJ3GEYJ 101 V (100)	B	151.7/73.1
R403	7030003520	S.RES ERJ3GEYJ 472 V (4.7K)	T	151.8/71.2
R404	7030000260	S.RES MCR10EZJH 100 (101)	T	149.4/36.6
R405	7030003540	S.RES ERJ3GEYJ 682 V (6.8K)	B	126.7/137.5
R406	7030003860	S.RES ERJ3GE JPW V	B	128.4/136.1
R407	7030003440	S.RES ERJ3GEYJ 102 V (1K)	B	129.7/133.6
R408	7030003860	S.RES ERJ3GE JPW V	B	124.1/137.6
R409	7030003440	S.RES ERJ3GEYJ 102 V (1K)	B	127/130.4
R410	7030003440	S.RES ERJ3GEYJ 102 V (1K)	B	131.6/133
R411	7030003540	S.RES ERJ3GEYJ 682 V (6.8K)	B	125.1/135.5
R412	7030003500	S.RES ERJ3GEYJ 332 V (3.3K)	B	131.1/129.7
R413	7030007160	S.RES ERJ12YJ3R3U (3.3)	B	123.5/125.1
R415	7030008350	S.RES ERJ12YJ390U	B	96.7/136.4
R416	7030000140	S.RES MCR10EZJH 10 (100)	B	83.8/130.7
R417	7030000140	S.RES MCR10EZJH 10 (100)	B	95.5/132.5
R418	7030000010	S.RES MCR10EZJH JPW (000)	B	99.3/133.9
R451	7030003470	S.RES ERJ3GEYJ 182 V (1.8K)	B	81.5/121.7
R452	7030004040	S.RES ERJ3GEYJ 4R7 V (4.7)	B	85.5/119.3
R453	7030003260	S.RES ERJ3GEYJ 330 V (33)	B	81.6/118.4
R454	7030003860	S.RES ERJ3GE JPW V	B	77.3/116
R455	7030003640	S.RES ERJ3GEYJ 473 V (47K)	B	73.2/117.5
R456	7030003700	S.RES ERJ3GEYJ 154 V (150K)	B	72/114.4
R457	7030003750	S.RES ERJ3GEYJ 394 V (390K)	B	71.2/111.9
R458	7030003710	S.RES ERJ3GEYJ 184 V (180K)	B	73.8/112.4
R459	7030003740	S.RES ERJ3GEYJ 334 V (330K)	B	69.6/111.3
R460	7030003740	S.RES ERJ3GEYJ 334 V (330K)	B	76.6/112.1
R461	7030003270	S.RES ERJ3GEYJ 390 V (39)	B	77.7/103.3
R462	7030003680	S.RES ERJ3GEYJ 104 V (100K)	B	72.9/99.6
R463	7030003520	S.RES ERJ3GEYJ 472 V (4.7K)	B	74.4/102.4
R464	7030003210	S.RES ERJ3GEYJ 120 V (12)	B	74.1/105.7
R465	7030003680	S.RES ERJ3GEYJ 104 V (100K)	B	66.5/101.7
R466	7030003860	S.RES ERJ3GE JPW V	B	62.1/100.2
R467	7030003640	S.RES ERJ3GEYJ 473 V (47K)	B	75.1/117.2
R468	7030008240	S.RES ERJ12Y0R00U	B	89.1/121.9
R470	7030003320	S.RES ERJ3GEYJ 101 V (100)	B	67.7/98.8
R471	7030003270	S.RES ERJ3GEYJ 390 V (39)	B	69.6/98.3
R472	7030003340	S.RES ERJ3GEYJ 151 V (150)	B	69.6/99.5
R473	7030003340	S.RES ERJ3GEYJ 151 V (150)	B	69.6/100.7
R474	7030003340	S.RES ERJ3GEYJ 151 V (150)	B	63.5/96.9
R475	7030003340	S.RES ERJ3GEYJ 151 V (150)	B	64.9/96.9
R476	7030003270	S.RES ERJ3GEYJ 390 V (39)	B	64.8/95.1
R477	7030003360	S.RES ERJ3GEYJ 221 V (220)	B	61.8/97.6
R502	7030003320	S.RES ERJ3GEYJ 101 V (100)	T	112.1/87.9
R503	7030003520	S.RES ERJ3GEYJ 472 V (4.7K)	T	112.6/86
R504	7030000260	S.RES MCR10EZJH 100 (101)	T	114.2/86.2
R505	7030003540	S.RES ERJ3GEYJ 682 V (6.8K)	B	119.9/124.8
R507	7030003440	S.RES ERJ3GEYJ 102 V (1K)	B	

[PA UNIT]

REF NO.	PARTS NO.	DESCRIPTION	M.	H/V LOCATION
R517	7030010520	S.RES ERJ1TYJ 101U (100)	B	103.7/118.4
R518	7030003440	S.RES ERJ3GEYJ 102 V (1K)	B	97.4/112.6
R519	7030000010	S.RES MCR10EZJH JPW (000)	B	111.1/119.1
R551	7030003470	S.RES ERJ3GEYJ 182 V (1.8K)	T	78.2/117.8
R552	7030004040	S.RES ERJ3GEYJ 4R7 V (4.7)	T	76.7/119.1
R553	7030003260	S.RES ERJ3GEYJ 330 V (33)	T	73/118.9
R554	7030003680	S.RES ERJ3GEYJ 104 V (100K)	T	66.8/120.4
R555	7030003440	S.RES ERJ3GEYJ 102 V (1K)	T	68.1/114.7
R556	7030003680	S.RES ERJ3GEYJ 104 V (100K)	T	69.9/116.6
R557	7030003740	S.RES ERJ3GEYJ 334 V (330K)	T	65.7/112.9
R558	7030003710	S.RES ERJ3GEYJ 184 V (180K)	T	70.5/111.2
R559	7030003720	S.RES ERJ3GEYJ 224 V (220K)	T	65.7/111.7
R560	7030003720	S.RES ERJ3GEYJ 224 V (220K)	T	65.6/110.5
R561	7030003740	S.RES ERJ3GEYJ 334 V (330K)	T	68.3/112.4
R562	7030003270	S.RES ERJ3GEYJ 390 V (39)	T	70.1/106.6
R563	7030003420	S.RES ERJ3GEYJ 681 V (680)	T	65.4/107.3
R564	7030003210	S.RES ERJ3GEYJ 120 V (12)	T	63.5/103
R565	7030003440	S.RES ERJ3GEYJ 102 V (1K)	B	65.6/106.3
R567	7030003680	S.RES ERJ3GEYJ 104 V (100K)	T	70.1/104
R568	7030003680	S.RES ERJ3GEYJ 104 V (100K)	T	69.7/100.7
R570	7030003380	S.RES ERJ3GEYJ 331 V (330)	T	62.8/100.3
R575	7030003520	S.RES ERJ3GEYJ 472 V (4.7K)	T	68.4/100.7
R576	7030003540	S.RES ERJ3GEYJ 682 V (6.8K)	T	71.8/100
R577	7030003520	S.RES ERJ3GEYJ 472 V (4.7K)	T	68/120.4
R578	7030003540	S.RES ERJ3GEYJ 682 V (6.8K)	T	69.9/119
R701	7030003500	S.RES ERJ3GEYJ 332 V (3.3K)	B	82.2/16.9
R702	7030003500	S.RES ERJ3GEYJ 332 V (3.3K)	B	83/14.5
R703	7030003500	S.RES ERJ3GEYJ 332 V (3.3K)	B	80.6/16.9
R704	7030003500	S.RES ERJ3GEYJ 332 V (3.3K)	B	79.7/14.5
R705	7030009300	S.RES ERJ1WY0R00U	B	134.6/23.8
R721	7030011240	S.RES LRF3W-LF-01-R020F	B	83/22.3
R722	7030011240	S.RES LRF3W-LF-01-R020F	B	83/29.6
R723	7030004040	S.RES ERJ3GEYJ 4R7 V (4.7)	B	140.5/14.7
R733	7030009591	S.RES ERA3YED 472V (4.7K)	B	138.6/10.4
R734	7510001470	S.THE NTCG20 4AG 473JT	T	111.9/58.2
R735	7030009591	S.RES ERA3YED 472V (4.7K)	B	140.2/12.5
R736	7510001470	S.THE NTCG20 4AG 473JT	T	153.3/77.1
R742	7030003640	S.RES ERJ3GEYJ 473 V (47K)	B	83.4/11.5
R743	7030003440	S.RES ERJ3GEYJ 102 V (1K)	B	80.2/10.9
R744	7030003860	S.RES ERJ3GE JPW V	T	67.8/9.6
R749	7030003860	S.RES ERJ3GE JPW V	B	65/5.2
R750	7030003860	S.RES ERJ3GE JPW V	B	66.6/5.2
R773	7030003860	S.RES ERJ3GE JPW V	T	103.4/9.5
R960	7030003860	S.RES ERJ3GE JPW V	B	43.2/125.7
R961	7030003380	S.RES ERJ3GEYJ 331 V (330)	B	42/138.3
R962	7030003440	S.RES ERJ3GEYJ 102 V (1K)	B	37.4/137.8
R963	7030003440	S.RES ERJ3GEYJ 102 V (1K)	B	40.3/126.3
R964	7030003860	S.RES ERJ3GE JPW V	B	24.8/131.2
R965	7030003640	S.RES ERJ3GEYJ 473 V (47K)	B	32.6/130.5
R966	7030008190	S.RES ERJ12YJ330U (33)	B	11.1/129.6
R967	7030003640	S.RES ERJ3GEYJ 473 V (47K)	B	34.2/130.5
R968	7030003860	S.RES ERJ3GE JPW V	B	24.8/132.8
R969	7030003600	S.RES ERJ3GEYJ 223 V (22K)	B	32.6/133.6
R970	7030003680	S.RES ERJ3GEYJ 104 V (100K)	B	34.2/133.6
R971	7540000130	ABS 2P-50A-301		
R972	7030003620	S.RES ERJ3GEYJ 333 V (33K)	B	17.4/140.1
R973	7030003620	S.RES ERJ3GEYJ 333 V (33K)	B	18.9/138.5
R974	7030003620	S.RES ERJ3GEYJ 333 V (33K)	B	19.4/136.6
R994	7030003560	S.RES ERJ3GEYJ 103 V (10K)	B	22.4/2.6
R995	7030003560	S.RES ERJ3GEYJ 103 V (10K)	B	22.4/6.8
R996	7030003560	S.RES ERJ3GEYJ 103 V (10K)	B	21.6/5.4
R997	7030003560	S.RES ERJ3GEYJ 103 V (10K)	B	21.6/8.2
R998	7030003320	S.RES ERJ3GEYJ 101 V (100)	T	54.1/4.4
R999	7030003320	S.RES ERJ3GEYJ 101 V (100)	T	54.5/3.1
R1000	7030003320	S.RES ERJ3GEYJ 101 V (100)	T	51.2/3.5
R1001	7030003320	S.RES ERJ3GEYJ 101 V (100)	T	49.3/4.9
R1002	7030000280	S.RES MCR10EZJH 150 (151)	T	48/9.7
R1003	7030000290	S.RES MCR10EZJH 180 (181)	T	47.5/7.9
C101	4030011600	S.CER C1608 JB 1E 104K-T	T	151.9/25.1
C102	4030011600	S.CER C1608 JB 1E 104K-T	B	150.8/29.3
C103	4030011340	S.CER C1608 CH 1H 471J-T	T	152.7/27.2
C104	4030011600	S.CER C1608 JB 1E 104K-T	T	147.8/32.2
C105	4510004591	ELE 16 ME 470 HC		
C106	4030011600	S.CER C1608 JB 1E 104K-T	B	142.7/29.2
C107	4030011600	S.CER C1608 JB 1E 104K-T	T	151.6/39.7
C108	4030011600	S.CER C1608 JB 1E 104K-T	T	149.2/36.5
C109	4030007130	S.CER C1608 CH 1H 101J-T	B	146.6/42.1
C112	4030011600	S.CER C1608 JB 1E 104K-T	B	139.2/35.1
C113	4030011600	S.CER C1608 JB 1E 104K-T	T	144.6/44.4
C114	4030011600	S.CER C1608 JB 1E 104K-T	B	134.1/37
C116	4030007090	S.CER C1608 CH 1H 470J-T [USA] only	T	144.6/45.8
C118	4030007130	S.CER C1608 CH 1H 101J-T	T	143.5/48.5
C119	4030007130	S.CER C1608 CH 1H 101J-T	T	144/50.4
C120	4030007020	S.CER C1608 CH 1H 120J-T	T	143.5/47.2
C122	4510008500	S.ELE EEE1CA101WP	T	121.5/11.2
C151	4030011600	S.CER C1608 JB 1E 104K-T	T	59.2/54.8
C152	4030006880	S.CER C1608 JB 1H 472K-T	B	61.6/36.2
C153	4030011600	S.CER C1608 JB 1E 104K-T	B	63.1/56
C154	4030006860	S.CER C1608 JB 1H 102K-T	B	63.1/54.7
C201	4030006860	S.CER C1608 JB 1H 102K-T	T	145.6/53
C202	4030006860	S.CER C1608 JB 1H 102K-T	T	143/53
C204	4030011600	S.CER C1608 JB 1E 104K-T	B	139.3/48.4
C205	4030006860	S.CER C1608 JB 1H 102K-T	B	123.3/48.6
C206	4030017810	S.CER C1608 CH 1H 102J-T	B	133.5/50.6
C207	4030017810	S.CER C1608 CH 1H 102J-T	B	139.3/49.7
C208	4030011600	S.CER C1608 JB 1E 104K-T	B	132/50.6

[PA UNIT]

REF NO.	PARTS NO.	DESCRIPTION	M.	H/V LOCATION
C209	4030007170	S.CER C1608 CH 1H 221J-T	B	139.3/51
C211	4030011160	S.CER GRM42-6 500V CH 15P [EUR], [FRA], [ESP]	B	139.3/55.3
C214	4030018940	S.CER GRM31A7U2J331JW31D	T	116.3/76.1
C215	4030018930	S.CER GRM31A7U2J221JW31D	T	122.2/73.9
C217	4030011600	S.CER C1608 JB 1E 104K-T	T	144.3/53
C218	4030018930	S.CER GRM31A7U2J221JW31D	T	101/88.5
C219	4030018930	S.CER GRM31A7U2J221JW31D	B	82.4/99.7
C251	4030011180	S.CER GRM31M2C2H220JV01L (GRM42-6 CH)	B	134.9/66
C252	4030011180	S.CER GRM31M2C2H220JV01L (GRM42-6 CH)	B	142.2/70.6
C253	4030011080	S.CER GRM31M2C2H6R0DV01L (GRM42-6 CH)	B	145.5/79
C254	4030011160	S.CER GRM31M2C2H150JV01L (GRM42-6 CH)	B	127.7/65.3
C261	4030012480	S.CER GRM31M2C2H121JV01L (GRM42-6 CH)	B	131.7/75.1
C262	4030018940	S.CER GRM31A7U2J331JW31D	B	126/80.1
C263	4030018770	S.CER C3216 CH 2J 102J-T	B	122.1/80.7
C266	4030018950	S.CER GRM31A7U2J681JW31D	B	119.7/80.2
C267	4030018930	S.CER GRM31A7U2J221JW31D	B	124/85.3
C301	4030001100	S.CER GRM216B11H102KA01D (GRM40 B)	B	91.7/100.6
C302	4030001020	S.CER GRM216C21H121JA01D (GRM40 CH)	B	93.8/100.6
C303	4030011600	S.CER C1608 JB 1E 104K-T	B	110.8/85.5
C304	4030017320	S.CER GRM21BB11H104KA01L (GRM40-034)	B	94.8/97.6
C305	4510004591	ELE 16 ME 470 HC		
C306	4030004720	S.CER C2012 JB 1H 102K-T [EUR]	B	83.6/39.8
	4030004720	S.CER C2012 JB 1H 102K-T [FRA]		
	4030004720	S.CER C2012 JB 1H 102K-T [ESP]		
	4030004720	S.CER C2012 JB 1H 102K-T [USA]		
	4030004720	S.CER C2012 JB 1H 102K-T [EXP]		
	4030004720	S.CER C2012 JB 1H 102K-T [ITR]		
	4030004720	S.CER C2012 JB 1H 102K-T [UK]		
	4030004720	S.CER C2012 JB 1H 102K-T [KOR]		
	4030006860	S.CER C1608 JB 1H 102K-T [AUS]		
C307	4030004720	S.CER C2012 JB 1H 102K-T [CHN]	B	100.6/39.8
	4030004720	S.CER C2012 JB 1H 102K-T [FRA]		
	4030004720	S.CER C2012 JB 1H 102K-T [ESP]		
	4030004720	S.CER C2012 JB 1H 102K-T [USA]		
	4030004720	S.CER C2012 JB 1H 102K-T [EXP]		
	4030004720	S.CER C2012 JB 1H 102K-T [ITR]		
	4030004720	S.CER C2012 JB 1H 102K-T [UK]		
	4030006860	S.CER C1608 JB 1H 102K-T [AUS]		
C308	4030004720	S.CER C2012 JB 1H 102K-T [CHN]	B	91.9/10.9
	4030004720	S.CER C2012 JB 1H 102K-T [EUR]		
	4030004720	S.CER C2012 JB 1H 102K-T [FRA]		
	4030004720	S.CER C2012 JB 1H 102K-T [ESP]		
	4030004720	S.CER C2012 JB 1H 102K-T [USA]		
	4030004720	S.CER C2012 JB 1H 102K-T [EXP]		
	4030004720	S.CER C2012 JB 1H 102K-T [ITR]		
	4030004720	S.CER C2012 JB 1H 102K-T [UK]		
	4030004720	S.CER C2012 JB 1H 102K-T [KOR]		
	4030006860	S.CER C1608 JB 1H 102K-T [AUS]		
	4030004720	S.CER C2012 JB 1H 102K-T [CHN]		
C309	4030011600	S.CER C1608 JB 1E 104K-T	T	105.8/78.3
C311	4030018750	S.CER C3225 CH 2J 682K-T	B	92.7/78.5
C312	4030018750	S.CER C3225 CH 2J 682K-T	B	84.9/78.5
C313	4030011600	S.CER C1608 JB 1E 104K-T	T	76.8/87.8
C314	4030018750	S.CER C3225 CH 2J 682K-T	B	96.9/77.6
C315	4030018750	S.CER C3225 CH 2J 682K-T	B	80.6/77.6
C319	4030011730	S.CER GRM31M2C2H101JV01L (GRM42-6 CH)	B	110/48.8
C320	4030011730	S.CER GRM31M2C2H101JV01L (GRM42-6 CH)	B	71.1/48.9
C323	4030003810	S.MIC UC342H 1200J-T	B	91.4/46.4
C324	4320001050	S.MIC UC342H 3900J-T	T	94.4/40.2
C325	4320001070	S.MIC UC342H 3300J-T	B	94.4/40.7
C327	4030011790	S.CER GRM55RF52A684ZD01L (GRM44-1)	T	65.9/46.3
C331	4030011600	S.CER C1608 JB 1E 104K-T	T	108.3/78.3
C332	4030011600	S.CER C1608 JB 1E 104K-T	B	69.5/81.4
C333	4030018940	S.CER GRM31A7U2J331JW31D	B	88.4/101.8
C340	4030006860	S.CER C1608 JB 1H 102K-T	B	82.3/107.3
C341	4030006860	S.CER C1608 JB 1H 102K-T	B	92.4/107.4
C342	4030006860	S.CER C1608 JB 1H 102K-T	B	87.1/91.6
C350	4030004720	S.CER C2012 JB 1H 102K-T [EUR]	B	103.4/39.8
	4030004720	S.CER C2012 JB 1H 102K-T [FRA]		
	4030004720	S.CER C2012 JB 1H 102K-T [ESP]		
	4030004720	S.CER C2012 JB 1H 102K-T [USA]		
	4030004720	S.CER C2012 JB 1H 102K-T [EXP]		
	4030004720	S.CER C2012 JB 1H 102K-T [ITR]		
	4030004720	S.CER C2012 JB 1H 102K-T [UK]		
	4030004720	S.CER C2012 JB 1H 102K-T [KOR]		
	4030004720	S.CER C2012 JB 1H 102K-T [CHN]		

M.=Mounted side (T: Mounted on the Top side, B: Mounted on the Bottom side) S.=Surface mount

[PA UNIT]

REF NO.	PARTS NO.	DESCRIPTION	M.	H/V LOCATION
C351	4030004720	S.CER C2012 JB 1H 102K-T [EUR]	B	106.1/39.8
	4030004720	S.CER C2012 JB 1H 102K-T [FRA]		
	4030004720	S.CER C2012 JB 1H 102K-T [ESP]		
	4030004720	S.CER C2012 JB 1H 102K-T [USA]		
	4030004720	S.CER C2012 JB 1H 102K-T [EXP]		
	4030004720	S.CER C2012 JB 1H 102K-T [ITR]		
	4030004720	S.CER C2012 JB 1H 102K-T [UK]		
	4030004720	S.CER C2012 JB 1H 102K-T [KOR]		
	4030004720	S.CER C2012 JB 1H 102K-T [CHN]		
	4030004720	S.CER C2012 JB 1H 102K-T [EUR]		
C353	4030004720	S.CER C2012 JB 1H 102K-T [FRA]	B	86.3/39.8
	4030004720	S.CER C2012 JB 1H 102K-T [ESP]		
	4030004720	S.CER C2012 JB 1H 102K-T [USA]		
	4030004720	S.CER C2012 JB 1H 102K-T [EXP]		
	4030004720	S.CER C2012 JB 1H 102K-T [ITR]		
	4030004720	S.CER C2012 JB 1H 102K-T [UK]		
	4030004720	S.CER C2012 JB 1H 102K-T [KOR]		
	4030004720	S.CER C2012 JB 1H 102K-T [CHN]		
	4030004720	S.CER C2012 JB 1H 102K-T [EUR]		
	4030004720	S.CER C2012 JB 1H 102K-T [FRA]		
C354	4030004720	S.CER C2012 JB 1H 102K-T [ESP]	B	89.1/39.8
	4030004720	S.CER C2012 JB 1H 102K-T [USA]		
	4030004720	S.CER C2012 JB 1H 102K-T [EXP]		
	4030004720	S.CER C2012 JB 1H 102K-T [ITR]		
	4030004720	S.CER C2012 JB 1H 102K-T [UK]		
	4030004720	S.CER C2012 JB 1H 102K-T [KOR]		
	4030004720	S.CER C2012 JB 1H 102K-T [CHN]		
	4030004720	S.CER C2012 JB 1H 102K-T [EUR]		
	4030004720	S.CER C2012 JB 1H 102K-T [FRA]		
	4030004720	S.CER C2012 JB 1H 102K-T [ESP]		
C356	4030004720	S.CER C2012 JB 1H 102K-T [USA]	B	97.5/10.9
	4030004720	S.CER C2012 JB 1H 102K-T [EXP]		
	4030004720	S.CER C2012 JB 1H 102K-T [ITR]		
	4030004720	S.CER C2012 JB 1H 102K-T [UK]		
	4030004720	S.CER C2012 JB 1H 102K-T [KOR]		
	4030004720	S.CER C2012 JB 1H 102K-T [CHN]		
	4030004720	S.CER C2012 JB 1H 102K-T [EUR]		
	4030004720	S.CER C2012 JB 1H 102K-T [FRA]		
	4030004720	S.CER C2012 JB 1H 102K-T [ESP]		
	4030004720	S.CER C2012 JB 1H 102K-T [USA]		
C357	4030004720	S.CER C2012 JB 1H 102K-T [EXP]	B	94.7/10.9
	4030004720	S.CER C2012 JB 1H 102K-T [ITR]		
	4030004720	S.CER C2012 JB 1H 102K-T [UK]		
	4030004720	S.CER C2012 JB 1H 102K-T [KOR]		
	4030004720	S.CER C2012 JB 1H 102K-T [CHN]		
	4030004720	S.CER C2012 JB 1H 102K-T [EUR]		
	4030004720	S.CER C2012 JB 1H 102K-T [FRA]		
	4030004720	S.CER C2012 JB 1H 102K-T [ESP]		
	4030004720	S.CER C2012 JB 1H 102K-T [USA]		
	4030004720	S.CER C2012 JB 1H 102K-T [EXP]		
C358	4030004720	S.CER C2012 JB 1H 102K-T [ITR]	B	90/91.6
	4030004720	S.CER C2012 JB 1H 102K-T [UK]		
	4030004720	S.CER C2012 JB 1H 102K-T [KOR]		
	4030004720	S.CER C2012 JB 1H 102K-T [CHN]		
	4030006860	S.CER C1608 JB 1H 102K-T [EUR]		
	4030006860	S.CER C1608 JB 1H 102K-T [FRA]		
	4030006860	S.CER C1608 JB 1H 102K-T [ESP]		
	4030006860	S.CER C1608 JB 1H 102K-T [USA]		
	4030006860	S.CER C1608 JB 1H 102K-T [EXP]		
	4030006860	S.CER C1608 JB 1H 102K-T [ITR]		
C359	4030006860	S.CER C1608 JB 1H 102K-T [UK]	B	94.9/107.4
	4030006860	S.CER C1608 JB 1H 102K-T [KOR]		
	4030006860	S.CER C1608 JB 1H 102K-T [CHN]		
	4030006860	S.CER C1608 JB 1H 102K-T [EUR]		
	4030006860	S.CER C1608 JB 1H 102K-T [FRA]		
	4030006860	S.CER C1608 JB 1H 102K-T [ESP]		
	4030006860	S.CER C1608 JB 1H 102K-T [USA]		
	4030006860	S.CER C1608 JB 1H 102K-T [EXP]		
	4030006860	S.CER C1608 JB 1H 102K-T [ITR]		
	4030006860	S.CER C1608 JB 1H 102K-T [UK]		
C360	4030006860	S.CER C1608 JB 1H 102K-T [KOR]	B	85/107.3
	4030006860	S.CER C1608 JB 1H 102K-T [CHN]		
	4030006860	S.CER C1608 JB 1H 102K-T [EUR]		
	4030006860	S.CER C1608 JB 1H 102K-T [FRA]		
	4030006860	S.CER C1608 JB 1H 102K-T [ESP]		
	4030006860	S.CER C1608 JB 1H 102K-T [USA]		
	4030006860	S.CER C1608 JB 1H 102K-T [EXP]		
	4030006860	S.CER C1608 JB 1H 102K-T [ITR]		
	4030006860	S.CER C1608 JB 1H 102K-T [UK]		
	4030006860	S.CER C1608 JB 1H 102K-T [KOR]		
C403	4030006860	S.CER C1608 JB 1H 102K-T	B	89.6/133.4
	4030006860	S.CER C1608 JB 1H 102K-T	B	151.7/71.4
C404	4030011740	S.CER GRM32N2C2H201JV01L (GRM42-2 CH)	T	145.3/105.7
C406	4030006860	S.CER C1608 JB 1H 102K-T	B	132.4/129.7
C408	4030018040	S.CER ERF22X 6C2H 180J D01L	B	134.2/93
C409	4030018040	S.CER ERF22X 6C2H 180J D01L	B	145.4/93
C410	4030018260	S.CER ERF22X 6C2H 150J D01L	B	145.4/96.4
C411	4030018260	S.CER ERF22X 6C2H 150J D01L	B	134.2/96.4
C412	4030018770	S.CER C3216 CH 2J 102J-T	T	136/111.5
C413	4030018770	S.CER C3216 CH 2J 102J-T	T	139.8/102.7
C415	4030018410	S.CER ERF22X 6C2H 2R0C D01L	T	143.1/139.4
C416	4030006880	S.CER C1608 JB 1H 472K-T	T	103.1/96.7
C417	4030018040	S.CER ERF22X 6C2H 180J D01L	T	139.2/136.2
C418	4030011120	S.CER GRM31M2C2H100JV01L (GRM42-6 CH)	B	134.1/134.2
C419	4030011020	S.CER GRM31M4C2H1R0CY21L (GRM42-6 CK)	B	132.6/138.2
C420	4030011080	S.CER GRM31M2C2H6R0DV01L (GRM42-6 CH)	B	129.2/139.5
C421	4030011020	S.CER GRM31M4C2H1R0CY21L (GRM42-6 CK)	B	120.6/136.8
C422	4030011120	S.CER GRM31M2C2H100JV01L (GRM42-6 CH)	B	121.7/141.1
C423	4030007090	S.CER C1608 CH 1H 470J-T	B	127.8/131.7

[PA UNIT]

REF NO.	PARTS NO.	DESCRIPTION	M.	H/V LOCATION
C424	4030011090	S.CER GRM31M2C2H7R0DV01L (GRM42-6 CH)	B	119/140.3
C425	4030011180	S.CER GRM31M2C2H220JV01L (GRM42-6 CH)	T	121.6/137.4
		S.CER C1608 JB 1H 102K-T	B	106.7/133.9
C426	4030006860	S.CER C1608 JB 1H 102K-T	B	102.6/139.6
C427	4030011020	S.CER GRM31M4C2H1R0CY21L (GRM42-6 CK)	[EUR]	B
		S.CER GRM31M4C2H1R0CY21L (GRM42-6 CK)	[FRA]	
		S.CER GRM31M4C2H1R0CY21L (GRM42-6 CK)	[ESP]	
		S.CER GRM31M4C2H1R0CY21L (GRM42-6 CK)	[USA]	
		S.CER GRM31M4C2H1R0CY21L (GRM42-6 CK)	[EXP]	
		S.CER GRM31M4C2H1R0CY21L (GRM42-6 CK)	[ITR]	
		S.CER GRM31M4C2H1R0CY21L (GRM42-6 CK)	[UK]	
		S.CER GRM31M4C2H1R0CY21L (GRM42-6 CK)	[KOR]	
		S.CER GRM31M4C2H1R0CY21L (GRM42-6 CK)	[CHN]	
		S.CER GRM31M4C2H1R0CY21L (GRM42-6 CK)	[AUS]	
C428	4030011090	S.CER GRM31M2C2H7R0DV01L (GRM42-6 CH)	T	97/138.1
C429	4030017940	S.CER ERF22X 6C2H 680J D01L	T	92.3/136.9
C430	4030019410	S.CER GRM31A7U2J471JW31D	B	94.2/138
C431	4030011070	S.CER GRM31M2C2H5R0CY21L (GRM42-6 CH)	T	86.9/133.8
C432	4030004820	S.CER C2012 CH 1H 050C-T	B	99.2/139.3
C433	4030011090	S.CER GRM31M2C2H7R0DV01L (GRM42-6 CH)	T	76.1/132.2
C434	4030006860	S.CER C1608 JB 1H 102K-T	B	89.9/124.9
C435	4030006860	S.CER C1608 JB 1H 102K-T	B	97.2/127.7
C436	4030006860	S.CER C1608 JB 1H 102K-T	T	98.4/130.9
C438	4030006850	S.CER C1608 JB 1H 471K-T	B	90.8/134
C439	4030006860	S.CER C1608 JB 1H 102K-T	B	92.8/133.1
C440	4030004710	S.CER C2012 JB 1H 471K-T	B	103.5/135.5
C441	4030011090	S.CER GRM31M2C2H7R0DV01L (GRM42-6 CH)	T	137.6/140.4
C443	4030011020	S.CER GRM31M4C2H1R0CY21L (GRM42-6 CK)	B	122.1/131
C444	4030006860	S.CER C1608 JB 1H 102K-T	B	59.3/117.9
C452	4030007020	S.CER C1608 CH 1H 120J-T	B	87.3/119.3
C453	4030006860	S.CER C1608 JB 1H 102K-T	T	63.9/117.3
C456	4030009350	S.CER C1608 CH 1H 3R5B-T	B	78.2/118.4
C458	4030006860	S.CER C1608 JB 1H 102K-T	T	73.8/113.1
C461	4030011600	S.CER C1608 JB 1E 104K-T	B	68.8/113.3
C462	4030011600	S.CER C1608 JB 1E 104K-T	B	77.1/110.8
C463	4030006860	S.CER C1608 JB 1H 102K-T	B	79.7/109.6
C464	4030011600	S.CER C1608 JB 1E 104K-T	B	77.7/105.9
C465	4030011600	S.CER C1608 JB 1E 104K-T	B	67.7/108.9
C466	4030006860	S.CER C1608 JB 1H 102K-T	B	77.7/104.6
C467	4030006860	S.CER C1608 JB 1H 102K-T	B	67.7/107.6
C468	4030007020	S.CER C1608 CH 1H 120J-T	B	73.7/101.1
C470	4030011600	S.CER C1608 JB 1E 104K-T	B	77.7/101.7
C471	4030006860	S.CER C1608 JB 1H 102K-T	B	77.7/100.4
C472	4030009500	S.CER C1608 CH 1H 0R5B-T	B	69.7/105.2
C473	4030007040	S.CER C1608 CH 1H 180J-T	B	69.7/104
C474	4030009530	S.CER C1608 CH 1H 030B-T	B	67.7/101.7
C475	4030006860	S.CER C1608 JB 1H 102K-T	B	66.5/98.8
C476	4030006860	S.CER C1608 JB 1H 102K-T	B	68/111.3
C477	4030006860	S.CER C1608 JB 1H 102K-T	B	79.1/121.9
C478	4030006860	S.CER C1608 JB 1H 102K-T	B	57.7/120.5
C479	4030006860	S.CER C1608 JB 1H 102K-T	B	56.9/121.8
C480	4030007090	S.CER C1608 CH 1H 470J-T	B	63.4/100.8
C481	4030006860	S.CER C1608 JB 1H 102K-T	B	69.6/96.3
C482	4030006860	S.CER C1608 JB 1H 102K-T	B	67.9/94.5
C483	4030006860	S.CER C1608 JB 1H 102K-T	B	64.2/98.8
C484	4030007010	S.CER C1608 CH 1H 100D-T	B	74.3/108.1
C485	4030017810	S.CER C1608 CH 1H 102J-T	B	69.8/107.4
C501	4030006860	S.CER C1608 JB 1H 102K-T	T	109.3/87.9
C503	4030011070	S.CER GRM31M2C2H5R0CY21L (GRM42-6 CH)	T	119.4/130.3
C504	4030017960	S.CER ERF22X 6C2H 330J D01L	T	111.8/122.1
C505	4030011040	S.CER GRM31M4C2H2R0CY21L (GRM42-6 CK)	B	114.4/125.4
C506	4030011120	S.CER GRM31M2C2H100JV01L (GRM42-6 CH)	B	118.2/125.6
C507	4030011040	S.CER GRM31M4C2H2R0CY21L (GRM42-6 CK)	B	113.8/131.5
C508	4030011070	S.CER GRM31M2C2H5R0CY21L (GRM42-6 CH)	B	110.4/132.8
C509	4030007150	S.CER C1608 CH 1H 151J-T	B	110.2/121.5
C511	4030018770	S.CER C3216 CH 2J 102J-T	T	109.6/125.4
C513	4030006860	S.CER C1608 JB 1H 102K-T	B	97.1/117.6
C514	4030011170	S.CER GRM31M2C2H180JV01L (GRM42-6 CH)	T	98.4/118.1
C515	4030018770	S.CER C3216 CH 2J 102J-T	T	96.9/120.4
C516	4030011100	S.CER GRM31M2C2H8R0DV01L (GRM42-6 CH)	T	88.2/124.1
C517	4030004880	S.CER C2012 CH 1H 120J-T	B	92.5/115.1
C518	4030018770	S.CER C3216 CH 2J 102J-T	B	94.1/121.4
C519	4030011190	S.CER GRM31M2C2H270JV01L (GRM42-6 CH)	T	86.1/124.1
C520	4030004870	S.CER C2012 CH 1H 100D-T	B	93.4/112.4

M.=Mounted side (T: Mounted on the Top side, B: Mounted on the Bottom side)
S.=Surface mount

[PA UNIT]

REF NO.	PARTS NO.	DESCRIPTION	M.	H/V LOCATION
C521	4030011290	S.CER GRM31M2C2H240JV01L (GRM42-6 CH)	T	81.2/123.9
C522	4030006850	S.CER C1608 JB 1H 471K-T	T	96.3/107.7
C523	4030006860	S.CER C1608 JB 1H 102K-T	T	79.3/119.1
C524	4030006910	S.CER C1608 CH 1H 0R5C-T	T	79.9/120.9
C525	4030004720	S.CER C2012 JB 1H 102K-T	T	86.7/112.1
C526	4030007150	S.CER C1608 CH 1H 151J-T	B	113.3/121.5
C527	4030007150	S.CER C1608 CH 1H 151J-T	B	111.1/127.8
C528	4030006860	S.CER C1608 JB 1H 102K-T	B	96.2/114.5
C530	4030011230	S.CER GRM31M2C2H390JV01L (GRM42-6 CH)	T	120.8/113.3
C531	4030018770	S.CER C3216 CH 2J 102J-T	B	106/109.3
C532	4030018770	S.CER C3216 CH 2J 102J-T	B	103.1/109.2
C533	4030018770	S.CER C3216 CH 2J 102J-T	T	118.6/107
C534	4030017880	S.CER ERF22X 6C2H 560J D01L (GRM111)	B	112.7/103.9
C535	4030017880	S.CER ERF22X 6C2H 560J D01L (GRM111)	B	124.1/103.9
C536	4030017980	S.CER ERF22X 6C2H 470J D01L	T	101/110.8
C537	4030017940	S.CER ERF22X 6C2H 680J D01L	T	101/114.2
C538	4030017880	S.CER ERF22X 6C2H 560J D01L (GRM111)	T	131.2/117.5
C541	4030011060	S.CER GRM31M2C2H4R0CY21L (GRM42-6 CH)	T	125.1/123.7
C542	4030012480	S.CER GRM31M2C2H121JV01L (GRM42-6 CH)	T	123.4/128.7
C544	4030011730	S.CER GRM31M2C2H101JV01L (GRM42-6 CH)	T	129.9/123.5
C545	4030017940	S.CER ERF22X 6C2H 680J D01L	B	112.7/109.9
C551	4030006880	S.CER C1608 JB 1H 472K-T	T	80.1/117.1
C552	4030006860	S.CER C1608 JB 1H 102K-T	T	73/120.5
C553	4030006850	S.CER C1608 JB 1H 471K-T	T	69.4/114.7
C554	4030006860	S.CER C1608 JB 1H 102K-T	T	66.8/114.7
C555	4030006860	S.CER C1608 JB 1H 102K-T	T	63.1/111.7
C556	4030011600	S.CER C1608 JB 1E 104K-T	T	68.3/111.2
C557	4030006860	S.CER C1608 JB 1H 102K-T	T	70.8/108.5
C558	4030006860	S.CER C1608 JB 1H 102K-T	T	65.4/108.6
C559	4030006860	S.CER C1608 JB 1H 102K-T	T	66/103.5
C560	4030006860	S.CER C1608 JB 1H 102K-T	B	65.3/112.9
C561	4030006850	S.CER C1608 JB 1H 471K-T	T	70.1/105.3
C562	4030006860	S.CER C1608 JB 1H 102K-T	T	69.2/94.9
C563	4030006860	S.CER C1608 JB 1H 102K-T	T	62.3/106.1
C564	4030006860	S.CER C1608 JB 1H 102K-T	T	65/97
C565	4030006860	S.CER C1608 JB 1H 102K-T	T	62.3/103
C567	4030006860	S.CER C1608 JB 1H 102K-T	T	69.2/120.9
C601	4030011070	S.CER GRM31M2C2H5R0CY21L (GRM42-6 CH)	T	69.5/132.7
C602	4030011090	S.CER GRM31M2C2H7R0DV01L (GRM42-6 CH)	T	67/136.8
C701	4030017320	S.CER GRM21BB11H104KA01L (GRM40-034)	B	109.8/33.4
C702	4030006860	S.CER C1608 JB 1H 102K-T	B	107.7/33.2
C703	4030011600	S.CER C1608 JB 1E 104K-T	B	83.8/16.9
C704	4510004601	ELE 16 ME 1000 HC		
C705	4030011600	S.CER C1608 JB 1E 104K-T	B	79/16.9
C706	4510004601	ELE 16 ME 1000 HC		
C707	4030017320	S.CER GRM21BB11H104KA01L (GRM40-034)	B	67.1/18.6
C708	4030006900	S.CER C1608 JB 1H 103K-T	T	63.2/27.8
C709	4030006860	S.CER C1608 JB 1H 102K-T	T	63.2/26.5
C710	4030006850	S.CER C1608 JB 1H 471K-T	T	63.2/25.2
C711	4030007170	S.CER C1608 CH 1H 221J-T	T	63.2/23.9
C712	4030007170	S.CER C1608 CH 1H 221J-T	B	70.4/18.7
C713	4510004591	ELE 16 ME 470 HC		
C715	4030006860	S.CER C1608 JB 1H 102K-T	B	97.1/118.9
C718	4030011600	S.CER C1608 JB 1E 104K-T	B	128.4/19.3
C719	4030011600	S.CER C1608 JB 1E 104K-T	T	125.8/16.4
C720	4030011600	S.CER C1608 JB 1E 104K-T	B	130.5/38.7
C722	4030007130	S.CER C1608 CH 1H 101J-T	T	88.9/16.7
C723	4030007130	S.CER C1608 CH 1H 101J-T	T	78.3/3.1
C724	4030011340	S.CER C1608 CH 1H 471J-T	B	134.8/12.2
C725	4550007350	S.TAN F931C226MCMBMA	B	126.6/35.3
C726	4030006860	S.CER C1608 JB 1H 102K-T	B	91.3/111
C727	4030006860	S.CER C1608 JB 1H 102K-T	B	84.4/114.1
C728	4030006860	S.CER C1608 JB 1H 102K-T	B	91.2/112.6
C729	4030006860	S.CER C1608 JB 1H 102K-T	B	65.1/114.8
C732	4030011600	S.CER C1608 JB 1E 104K-T	T	71.8/2.6
C733	4030011600	S.CER C1608 JB 1E 104K-T	T	66.8/12.9
C734	4030006860	S.CER C1608 JB 1H 102K-T	B	63.5/1.8
C735	4030011600	S.CER C1608 JB 1E 104K-T	T	74.1/13.2
C736	4030011600	S.CER C1608 JB 1E 104K-T	B	67.3/1.8
C737	4030011600	S.CER C1608 JB 1E 104K-T	B	65.4/1.8
C738	4030011600	S.CER C1608 JB 1E 104K-T	B	68.2/14.5
C739	4030011600	S.CER C1608 JB 1E 104K-T	B	69.8/14.5
C741	4030011600	S.CER C1608 JB 1E 104K-T	B	78.5/6.4
C742	4030011600	S.CER C1608 JB 1E 104K-T	T	69.4/12.9
C743	4030006860	S.CER C1608 JB 1H 102K-T	T	68.1/12.9
C744	4030011600	S.CER C1608 JB 1E 104K-T	T	70.7/12.9
C745	4030011600	S.CER C1608 JB 1E 104K-T	B	77.7/14.3
C746	4030011600	S.CER C1608 JB 1E 104K-T	B	76.2/15.1
C747	4030011600	S.CER C1608 JB 1E 104K-T	T	98.5/4.1
C749	4030011600	S.CER C1608 JB 1E 104K-T	T	96.6/6.4
C750	4030006880	S.CER C1608 JB 1H 472K-T	T	94.2/6.4
C751	4030006860	S.CER C1608 JB 1H 102K-T	T	95.4/6.4
C752	4030011600	S.CER C1608 JB 1E 104K-T	T	93/6.4
C753	4030006880	S.CER C1608 JB 1H 472K-T	B	59.9/10.7
C754	4030006860	S.CER C1608 JB 1H 102K-T	B	66.6/14.5
C755	4030006860	S.CER C1608 JB 1H 102K-T	B	58.5/119.2

[PA UNIT]

REF NO.	PARTS NO.	DESCRIPTION	M.	H/V LOCATION
C757	4030011600	S.CER C1608 JB 1E 104K-T	B	76.4/8
C759	4030006880	S.CER C1608 JB 1H 472K-T	T	72.8/13.2
C760	4030006880	S.CER C1608 JB 1H 472K-T	B	74.8/8
C761	4030006880	S.CER C1608 JB 1H 472K-T	B	73.2/8
C762	4030006880	S.CER C1608 JB 1H 472K-T	B	70/8
C763	4030006880	S.CER C1608 JB 1H 472K-T	B	71.6/8
C764	4030006880	S.CER C1608 JB 1H 472K-T	B	61.9/1.8
C765	4030011600	S.CER C1608 JB 1E 104K-T	B	68.9/1.8
C766	4030006860	S.CER C1608 JB 1H 102K-T	B	66.5/8.7
C781	4030006860	S.CER C1608 JB 1H 102K-T	T	73/90.1
C782	4030006900	S.CER C1608 JB 1H 103K-T	T	71.8/84.3
C783	4030006880	S.CER C1608 JB 1H 472K-T	T	71.8/83.1
C801	4030007070	S.CER C1608 CH 1H 330J-T	T	55/58.5
C802	4030009470	S.CER C1608 CH 1H R75C-T	T	53.7/58.5
C803	4030007100	S.CER C1608 CH 1H 560J-T	T	53.8/53.2
C804	4030007030	S.CER C1608 CH 1H 150J-T	T	56.2/52.5
C805	4030007080	S.CER C1608 CH 1H 390J-T	T	53.8/51.6
C806	4030006880	S.CER C1608 JB 1H 472K-T	B	47.1/39.8
C807	4030011600	S.CER C1608 JB 1E 104K-T	B	43.2/38.6
C808	4030011600	S.CER C1608 JB 1E 104K-T	B	43.1/44.5
C820	4030011600	S.CER C1608 JB 1E 104K-T	B	54.1/91.2
C821	4030006880	S.CER C1608 JB 1H 472K-T	B	53.5/99.2
C822	4030011510	S.CER GRM31M2C2H560JV01L (GRM42-6 CH)	B	42.2/21.9
C823	4030011190	S.CER GRM31M2C2H270JV01L (GRM42-6 CH)	B	32.9/18.3
C824	4030012480	S.CER GRM31M2C2H121JV01L (GRM42-6 CH)	B	25.1/17.1
C825	4030011240	S.CER GRM31M2C2H470JV01L (GRM42-6 CH)	B	17.9/15.7
C826	4030011550	S.CER GRM31M2C2H680JV01L (GRM42-6 CH)	B	11.2/19.9
C827	4030011510	S.CER GRM31M2C2H560JV01L (GRM42-6 CH)	B	8.8/19.9
C828	4030006880	S.CER C1608 JB 1H 472K-T	T	5.2/106.7
C829	4030011600	S.CER C1608 JB 1E 104K-T	T	2.6/106.7
C830	4030011210	S.CER GRM31M2C2H330JV01L (GRM42-6 CH)	B	22.4/17.1
C831	4030006880	S.CER C1608 JB 1H 472K-T	B	7.5/109.2
C832	4030006880	S.CER C1608 JB 1H 472K-T	B	51.5/95.4
C833	4030011730	S.CER GRM31M2C2H101JV01L (GRM42-6 CH)	B	27.5/17.1
C835	4030012480	S.CER GRM31M2C2H121JV01L (GRM42-6 CH)	B	16.6/107.1
C836	4030012480	S.CER GRM31M2C2H121JV01L (GRM42-6 CH)	B	12.5/107.8
C837	4030012480	S.CER GRM31M2C2H121JV01L (GRM42-6 CH)	B	12.5/105.7
C840	4030011600	S.CER C1608 JB 1E 104K-T	B	42.8/97.3
C841	4030006880	S.CER C1608 JB 1H 472K-T	B	46/98.5
C842	4030011730	S.CER GRM31M2C2H101JV01L (GRM42-6 CH)	B	39/106.8
C843	4010008160	CER HM13SJ SL 431J 500V		
C844	4030011730	S.CER GRM31M2C2H101JV01L (GRM42-6 CH)	B	25.9/102.9
C845	4030014460	S.CER GRM31M2C2H820JV01L (GRM42-6 CH)	B	19.7/91.9
C846	4010005370	CER HM11SJ SL 331J 500V		
C847	4010005930	CER HM11SJ SL 391J 500V		
C848	4030011190	S.CER GRM31M2C2H270JV01L (GRM42-6 CH)	B	12.5/98.2
C849	4030011180	S.CER GRM31M2C2H220JV01L (GRM42-6 CH)	B	12.6/96.1
C850	4010005930	CER HM11SJ SL 391J 500V		
C851	4030012480	S.CER GRM31M2C2H121JV01L (GRM42-6 CH)	B	20.2/112
C852	4030006880	S.CER C1608 JB 1H 472K-T	T	5.3/90.5
C853	4030011600	S.CER C1608 JB 1E 104K-T	T	2.6/90.5
C854	4030006880	S.CER C1608 JB 1H 472K-T	B	7.7/92.8
C855	4030011730	S.CER GRM31M2C2H101JV01L (GRM42-6 CH)	B	27.9/104.9
C856	4030011510	S.CER GRM31M2C2H560JV01L (GRM42-6 CH)	B	31.2/105.5
C857	4030012480	S.CER GRM31M2C2H121JV01L (GRM42-6 CH)	B	43.1/108.3
C858	4030011730	S.CER GRM31M2C2H101JV01L (GRM42-6 CH)	B	20.2/109.9
C860	4030011600	S.CER C1608 JB 1E 104K-T	B	43.4/83.8
C861	4030006880	S.CER C1608 JB 1H 472K-T	B	46.6/83.8
C863	4030011170	S.CER GRM31M2C2H180JV01L (GRM42-6 CH)	B	37.5/93.5
C864	4030011510	S.CER GRM31M2C2H560JV01L (GRM42-6 CH)	B	28.5/82.6
C865	4030011110	S.CER GRM31M2C2H9R0DV01L (GRM42-6 CH)	B	29.4/78.6
C866	4030011230	S.CER GRM31M2C2H390JV01L (GRM42-6 CH)	B	24.4/78
C868	4030011240	S.CER GRM31M2C2H470JV01L (GRM42-6 CH)	B	26.8/78.6
C869	4030011180	S.CER GRM31M2C2H220JV01L (GRM42-6 CH)	B	10.3/83.5
C870	4030011170	S.CER GRM31M2C2H180JV01L (GRM42-6 CH)	B	17/77.7
C871	4030006880	S.CER C1608 JB 1H 472K-T	T	5.2/74.4
C872	4030011600	S.CER C1608 JB 1E 104K-T	T	2.5/74.4
C873	4030011070	S.CER GRM31M2C2H5R0CY21L (GRM42-6 CH)	B	33.2/92.6

M.=Mounted side (T: Mounted on the Top side, B: Mounted on the Bottom side)
S.=Surface mount

[PA UNIT]

REF NO.	PARTS NO.	DESCRIPTION	M.	H/V LOCATION
C874	4030006880	S.CER C1608 JB 1H 472K-T	B	9/74.5
C876	4030011160	S.CER GRM31M2C2H150JV01L (GRM42-6 CH)	B	22/77.4
C880	4030011600	S.CER C1608 JB 1E 104K-T	B	43.4/69.1
C881	4030006880	S.CER C1608 JB 1H 472K-T	B	47/69.1
C882	4010007590	CER HM15SJ SL 681J 500V		
C883	4010007590	CER HM15SJ SL 681J 500V		
C884	4010005930	CER HM11SJ SL 391J 500V		
C885	4320000320	DIP DM20C 222J5		
C886	4030012480	S.CER GRM31M2C2H121JV01L (GRM42-6 CH)	B	31.5/57.2
C887	4030011730	S.CER GRM31M2C2H101JV01L (GRM42-6 CH)	B	33.9/57.2
C889	4030014460	S.CER GRM31M2C2H820JV01L (GRM42-6 CH)	B	18/65.3
C890	4320001250	DIP DM19C 162J5		
C893	4030006880	S.CER C1608 JB 1H 472K-T	T	5.3/58.3
C894	4030011600	S.CER C1608 JB 1E 104K-T	T	2.6/58.3
C900	4030011600	S.CER C1608 JB 1E 104K-T	B	44/54.4
C901	4030006880	S.CER C1608 JB 1H 472K-T	B	46.8/54.4
C902	4010005870	CER HM95SJ SL 221J 500V		
C903	4030011190	S.CER GRM31M2C2H270JV01L (GRM42-6 CH)	B	30.9/42.7
C904	4030014460	S.CER GRM31M2C2H820JV01L (GRM42-6 CH)	B	28.4/42.7
C905	4010005870	CER HM95SJ SL 221J 500V		
C906	4030011510	S.CER GRM31M2C2H560JV01L (GRM42-6 CH)	B	17/44
C907	4030011510	S.CER GRM31M2C2H560JV01L (GRM42-6 CH)	B	10.8/49.5
C908	4030006880	S.CER C1608 JB 1H 472K-T	T	5.3/42.1
C909	4030011600	S.CER C1608 JB 1E 104K-T	T	2.6/42.1
C920	4030011600	S.CER C1608 JB 1E 104K-T	B	43.2/25.1
C921	4030006880	S.CER C1608 JB 1H 472K-T	B	47.1/25.4
C922	4010007590	CER HM15SJ SL 681J 500V		
C923	4030011730	S.CER GRM31M2C2H101JV01L (GRM42-6 CH)	B	31.4/27.3
C924	4010006410	CER HM13SJ SL 471J 500V		
C925	4030014460	S.CER GRM31M2C2H820JV01L (GRM42-6 CH)	B	15.7/29.5
C926	4010006410	CER HM13SJ SL 471J 500V		
C927	4010005930	CER HM11SJ SL 391J 500V		
C928	4010005930	CER HM11SJ SL 391J 500V		
C929	4030006880	S.CER C1608 JB 1H 472K-T	T	5.3/25.8
C930	4030011600	S.CER C1608 JB 1E 104K-T	T	2.6/25.8
C931	4030014460	S.CER GRM31M2C2H820JV01L (GRM42-6 CH)	B	34.1/27.3
C932	4030011730	S.CER GRM31M2C2H101JV01L (GRM42-6 CH)	B	33.3/32.4
C933	4030011730	S.CER GRM31M2C2H101JV01L (GRM42-6 CH)	B	29.7/30.9
C940	4030011600	S.CER C1608 JB 1E 104K-T	B	43.6/11.1
C941	4030006880	S.CER C1608 JB 1H 472K-T	B	43.6/14.2
C942	4030014460	S.CER GRM31M2C2H820JV01L (GRM42-6 CH)	B	39.5/119.2
C943	4030011210	S.CER GRM31M2C2H330JV01L (GRM42-6 CH)	B	28.9/111.7
C944	4030014460	S.CER GRM31M2C2H820JV01L (GRM42-6 CH)	B	24.7/118.4
C945	4030011170	S.CER GRM31M2C2H180JV01L (GRM42-6 CH)	B	16.5/118.1
C947	4030006880	S.CER C1608 JB 1H 472K-T	T	5.3/9.9
C948	4030011600	S.CER C1608 JB 1E 104K-T	T	2.6/9.9
C949	4030011050	S.CER GRM31M3C2H3R0CY21L (GRM42-6 CJ)	B	28.9/109.6
C960	4030010760	S.CER C1608 CH 1H 331J-T	T	18.1/130.2
C961	4030011600	S.CER C1608 JB 1E 104K-T	B	45.1/134.1
C962	4030006880	S.CER C1608 JB 1H 472K-T	B	39/137.8
C963	4030006880	S.CER C1608 JB 1H 472K-T	B	38.7/126.3
C964	4610002120	S.TRI TZB4Z100EB10R00 (TZBX4Z100BE110)	T	3.3/126.6
C966	4030006880	S.CER C1608 JB 1H 472K-T	B	21.2/131.2
C968	4030011340	S.CER C1608 CH 1H 471J-T	B	31/130.5
C969	4030011340	S.CER C1608 CH 1H 471J-T	B	31/133.6
C970	4030010760	S.CER C1608 CH 1H 331J-T	B	22/132.8
C971	4030011340	S.CER C1608 CH 1H 471J-T	B	35.8/133.6
C972	4030011790	S.CER GRM55RF52A684ZD01L (GRM44-1)	B	3.4/136.4
C973	4030007090	S.CER C1608 CH 1H 470J-T	B	8.3/129.8
C979	4030006880	S.CER C1608 JB 1H 472K-T	T	51.8/38.6
C987	4030006880	S.CER C1608 JB 1H 472K-T	B	28.9/3.3
C988	4030006880	S.CER C1608 JB 1H 472K-T	B	26.3/3.3
C989	4030006880	S.CER C1608 JB 1H 472K-T	B	25/2.6
C990	4030006880	S.CER C1608 JB 1H 472K-T	T	20.6/3
C991	4030006880	S.CER C1608 JB 1H 472K-T	T	20.6/4.2
C992	4030006880	S.CER C1608 JB 1H 472K-T	T	20.6/5.4
C993	4030006880	S.CER C1608 JB 1H 472K-T	T	20.6/6.6
C994	4030011600	S.CER C1608 JB 1E 104K-T	B	29.5/6.1
C995	4030006880	S.CER C1608 JB 1H 472K-T	B	23.7/3.4
C996	4030007090	S.CER C1608 CH 1H 470J-T	T	20.6/9
C997	4030007090	S.CER C1608 CH 1H 470J-T	T	20.6/7.8
C998	4030007090	S.CER C1608 CH 1H 470J-T	T	20.6/10.2
C999	4030006860	S.CER C1608 JB 1H 102K-T	T	56.8/9.5
C1000	4030006860	S.CER C1608 JB 1H 102K-T	B	55.5/5
C1001	4030011600	S.CER C1608 JB 1E 104K-T	B	51.6/1.7
C1002	4030006880	S.CER C1608 JB 1H 472K-T	B	27.6/2.6
C1003	4030011600	S.CER C1608 JB 1E 104K-T	T	49.8/7.6

[PA UNIT]

REF NO.	PARTS NO.	DESCRIPTION	M.	H/V LOCATION
C1004	4030011510	S.CER GRM31M2C2H560JV01L (GRM42-6 CH)	B	39.8/21.9
C1005	4030011550	S.CER GRM31M2C2H680JV01L (GRM42-6 CH)	B	16.8/91.9
C1006	4030014460	S.CER GRM31M2C2H820JV01L (GRM42-6 CH)	B	39/109.2
C1007	4030011550	S.CER GRM31M2C2H680JV01L (GRM42-6 CH)	B	18.1/62.1
C1009	4030011510	S.CER GRM31M2C2H560JV01L (GRM42-6 CH)	B	20.6/118.7
C1010	4030014460	S.CER GRM31M2C2H820JV01L (GRM42-6 CH)	B	27.1/119.5
C1121	4010006410	CER HM13SJ SL 471J 500V		
RL701	6330001550	REL JV-12-KT		
RL801	6330001721	REL ATN207-K1		
RL820	6330001721	REL ATN207-K1		
RL821	6330001721	REL ATN207-K1		
RL840	6330001721	REL ATN207-K1		
RL841	6330001721	REL ATN207-K1		
RL860	6330001721	REL ATN207-K1		
RL861	6330001721	REL ATN207-K1		
RL880	6330001721	REL ATN207-K1		
RL881	6330001721	REL ATN207-K1		
RL900	6330001721	REL ATN207-K1		
RL901	6330001721	REL ATN207-K1		
RL920	6330001721	REL ATN207-K1		
RL921	6330001721	REL ATN207-K1		
RL940	6330001721	REL ATN207-K1		
RL941	6330001721	REL ATN207-K1		
J2	6510023511	S.CON 28FLT-SM2-TB(LF)(SN)	T	80.1/6
J980	6510023511	S.CON 28FLT-SM2-TB(LF)(SN)	T	63.7/6
F1	5220000341	HOL FHA010-03F		
F2	5210000940	FUS 1205		
W801	7120000480	S.JUM MJP-0.4-T	B	8.3/100.9
W901	7120000480	S.JUM MJP-0.4-T	T	56.7/22
EP202	6910012350	S.BEA MMZ1608Y 102BT	B	136/51.3
EP703	6910012350	S.BEA MMZ1608Y 102BT	B	142.6/13.9
EP741	6910012350	S.BEA MMZ1608Y 102BT	B	76.4/11.9
EP742	6910012350	S.BEA MMZ1608Y 102BT	B	77.8/11.3
EP743	6910012350	S.BEA MMZ1608Y 102BT	B	59.8/99.5
EP747	6910012350	S.BEA MMZ1608Y 102BT	T	65/9.6
EP748	6910012350	S.BEA MMZ1608Y 102BT	T	63.8/9.6
EP751	6910012350	S.BEA MMZ1608Y 102BT	T	74.1/9.6
EP752	6910012350	S.BEA MMZ1608Y 102BT	B	63.4/5.2
EP753	6910012350	S.BEA MMZ1608Y 102BT	T	66.4/9.6
EP754	6910012350	S.BEA MMZ1608Y 102BT	B	59.3/115.8
EP756	6910012350	S.BEA MMZ1608Y 102BT	T	68.6/2.6
EP758	6910012350	S.BEA MMZ1608Y 102BT	T	70.3/9.6
EP759	6910012350	S.BEA MMZ1608Y 102BT	T	69.1/9.6
EP760	6910012350	S.BEA MMZ1608Y 102BT	T	60.6/10
EP761	6910012350	S.BEA MMZ1608Y 102BT	T	62.5/9.6
EP762	6910012350	S.BEA MMZ1608Y 102BT	B	61/4.6
EP763	6910012350	S.BEA MMZ1608Y 102BT	B	63.3/105.6
EP767	6910012350	S.BEA MMZ1608Y 102BT	B	76.4/5.2
EP772	6910012350	S.BEA MMZ1608Y 102BT	T	96.4/3.8
EP774	6910012350	S.BEA MMZ1608Y 102BT	T	72.8/9.6
EP775	6910012350	S.BEA MMZ1608Y 102BT	B	74.8/5.2
EP776	6910012350	S.BEA MMZ1608Y 102BT	B	73.2/5.2
EP777	6910012350	S.BEA MMZ1608Y 102BT	B	70/5.2
EP778	6910012350	S.BEA MMZ1608Y 102BT	B	71.6/5.2
EP779	6910012350	S.BEA MMZ1608Y 102BT	B	68.2/5.2

M.=Mounted side (T: Mounted on the Top side, B: Mounted on the Bottom side)
S.=Surface mount

[DRIVER UNIT]

REF NO.	PARTS NO.	DESCRIPTION	M.	H/V LOCATION
Q504	1590003061	S.FET PD55015-E	T	20/9.7
R102	7070000271	RES ERG1SJ 101 (100)		
R103	7030000020	RES MCR10 1 [EUR], [FRA], [ESP]		
C101	4030004750	S.CER C2012 JB 1H 103K-T	T	24.6/18.2
C102	4030011230	S.CER GRM31M2C2H390JV01L (GRM42-6 CH)	T	11.2/4.2
J101	6910016830	CON IMSA-9230B-1-04Z149-PT1		
J102	6910016830	CON IMSA-9230B-1-04Z149-PT1		
J103	6910016830	CON IMSA-9230B-1-04Z149-PT1		
J104	6910016830	CON IMSA-9230B-1-04Z149-PT1		
J107	6910016830	CON IMSA-9230B-1-04Z149-PT1		
MP1	8410002480	S.HEA 2429 PA HEATSINK	B	20/9.7

[DISPLAY UNIT]

REF NO.	PARTS NO.	DESCRIPTION	M.	H/V LOCATION
IC1	6910016730	S.DC XC9504B092ARN	B	44.4/9.4
IC101	1180001072	S.IC TA7805F(TE16L1,NQ)	B	90.3/6.9
IC151	1180002201	S.IC RN5RZ33BA-TR-F	B	99.9/4.8
IC301	1110002751	S.IC TA75501F(TE85R,F)	B	113.8/7.5
IC506	1120003010	S.IC AN2533FH-V	B	69/38.5
IC651	1110005420	S.IC BA15532F-E2	B	4.1/25.6
IC2003	1140013140	S.IC HD64338020SB68HV(SX-2427C)	B	93/26.3
IC2007	1110005821	S.IC R3112N281A-TR-F	B	108.7/46.9
Q1	1550000090	S.FET RSQ035P03TR	B	39.4/9.8
Q51	1560001330	S.FET RSR025N03	B	52.1/10.6
Q301	1560001290	S.FET 2SK3065 T100	T	110.8/31.4
Q302	1590003940	S.TRA RN1105(TE85L,F)	T	116.7/10.2
Q303	1590003930	S.TRA UMD22N TR	T	113.1/11.5
Q651	1590001650	S.TRA XP4601(TX)	B	10.6/28.8
Q652	1590001650	S.TRA XP4601(TX)	B	11.1/20.6
Q653	1590001650	S.TRA XP4601(TX)	B	10.6/26.2
Q654	1590001650	S.TRA XP4601(TX)	B	11.1/17
Q701	1530002060	S.TRA 2SC4081 T106 R	T	19.1/50.3
Q721	1530002060	S.TRA 2SC4081 T106 R	T	22/5.8
Q741	1530002060	S.TRA 2SC4081 T106 R	T	94/50.1
Q761	1530002060	S.TRA 2SC4081 T106 R	T	104.2/50.1
Q771	1530002060	S.TRA 2SC4081 T106 R	T	18.4/25.1
Q781	1530002060	S.TRA 2SC4081 T106 R	T	5.3/23.6
Q802	1520000460	S.TRA 2SB1132 T100 R	B	58.8/21.6
Q851	1590002771	S.FET CPH3404-TL-E	B	39.9/18.4
Q2001	1590003940	S.TRA RN1105(TE85L,F)	B	81.6/23.7
Q2002	1590001870	S.TRA DTA114EE TL	B	80.1/29.7
Q2003	1590003480	S.TRA DTC114TE TL	B	82.2/32.3
D1	1790000971	S.DIO MA2J7290GL	B	36.8/10.1
D51	1750000731	S.DIO MA2SD100GL	B	51/8
D301	1790001251	S.DIO MA2S1110GL	B	111/32
D302	1790001521	S.ZEN MAZ8075GLL	B	109.9/7.6
D601	1750000951	S.DIO MA2J7320GL	B	51.5/39.8
D602	1750000951	S.DIO MA2J7320GL	B	53.3/39.8
D801	1730002341	S.ZEN MAZ8047GML	B	35/40.4
D802	1730002341	S.ZEN MAZ8047GML	B	39.8/25.9
D803	1730002341	S.ZEN MAZ8047GML	B	39.5/22.8
D804	1730002341	S.ZEN MAZ8047GML	B	42/22.9
D2001	1750000951	S.DIO MA2J7320GL	T	107.4/26.5
D2002	1790001670	S.DIO RB706F-40T106	B	76.6/16.8
D2003	1790001670	S.DIO RB706F-40T106	T	116.4/36.7
D2004	1750000370	S.DIO DA221 TL	T	100.6/41.8
D2005	1750000370	S.DIO DA221 TL	B	101.7/42.8
D2006	1750000370	S.DIO DA221 TL	B	107.3/5.9
X501	6050012150	S.XTA CR-806 SMD-49TA 4.433619 MHz <KDS> [EUR]	B	87/43.5
	6050012150	S.XTA CR-806 SMD-49TA 4.433619 MHz <KDS> [FRA]		
	6050012150	S.XTA CR-806 SMD-49TA 4.433619 MHz <KDS> [ESP]		
	6050012140	S.XTA CR-805 SMD-49TA 3.579545 MHz <KDS> [USA]		
	6050012150	S.XTA CR-806 SMD-49TA 4.433619 MHz <KDS> [EXP]		
	6050012150	S.XTA CR-806 SMD-49TA 4.433619 MHz <KDS> [ITR]		
	6050012150	S.XTA CR-806 SMD-49TA 4.433619 MHz <KDS> [UK]		
	6050012140	S.XTA CR-805 SMD-49TA 3.579545 MHz <KDS> [KOR]		
	6050012150	S.XTA CR-806 SMD-49TA 4.433619 MHz <KDS> [AUS]		
	6050012150	S.XTA CR-806 SMD-49TA 4.433619 MHz <KDS> [CHN]		
X2001	6050011550	S.XTA CR-747 SMD-49TA 9.8304 MHz <KDS>	B	106.5/27
L1	6190001561	S.COI CDRH5D18NP-101NCI	B	68.4/6.3
L2	6190001561	S.COI CDRH5D18NP-101NCI	B	34.6/5.2
L3	6200002041	S.COI NLV25T-101J	B	30.7/10.4
L51	6190001561	S.COI CDRH5D18NP-101NCI	B	55.9/6.2
L53	6200002041	S.COI NLV25T-101J	B	60.9/10.9
L101	6200001831	S.COI NLV32T-100J	B	96/11.6
L151	6200001831	S.COI NLV32T-100J	B	96/8.6
L152	6200001831	S.COI NLV32T-100J	B	100.6/11.4
L251	6200003950	S.COI HF50ACC 322513-T	B	145.8/44
L252	6200003950	S.COI HF50ACC 322513-T	B	145.2/50.9
L301	6200002041	S.COI NLV25T-101J	B	109.6/16.7
L302	6200005011	S.COI NLV25T-100J	T	112.6/24
L303	6200002041	S.COI NLV25T-101J	T	112/20.3
L306	6200003261	S.COI NLV32T-101J	T	109.8/25.5
L307	6200002041	S.COI NLV25T-101J	T	115.4/26.6
L309	6200002041	S.COI NLV25T-101J	T	115.3/24
L310	6200002041	S.COI NLV25T-101J	T	115.4/21.5
L312	6200002041	S.COI NLV25T-101J	T	115.4/19
L313	6200002041	S.COI NLV25T-101J	T	115.7/16.3
L505	6200005521	S.COI NLV25T-470J	B	71.2/47.9
L506	6200005011	S.COI NLV25T-100J	B	67.9/20.2
L507	6200005011	S.COI NLV25T-100J	B	50.2/29
L508	6200005011	S.COI NLV25T-100J	B	49.3/24.3
L509	6200005011	S.COI NLV25T-100J	B	17.4/35.6

M.=Mounted side (T: Mounted on the Top side, B: Mounted on the Bottom side)
S.=Surface mount

[DISPLAY UNIT]

REF NO.	PARTS NO.	DESCRIPTION	M.	H/V LOCATION
L601	6200002041	S.COI NLV25T-101J	B	70.6/25.2
L602	6200005011	S.COI NLV25T-100J	B	53.5/36.2
L603	6200005011	S.COI NLV25T-100J	B	51/43.3
L604	6200005011	S.COI NLV25T-100J	B	53.5/43.3
L605	6200005011	S.COI NLV25T-100J	B	50.9/36.2
L651	6200002041	S.COI NLV25T-101J	B	19.1/42.7
L701	6200002041	S.COI NLV25T-101J	B	21.1/37.5
L702	6200002041	S.COI NLV25T-101J	B	65.4/10.9
L703	6200002041	S.COI NLV25T-101J	B	27.9/11.3
L801	6200005011	S.COI NLV25T-100J	B	63.4/16.9
L802	6200002041	S.COI NLV25T-101J	B	19.1/47.5
L851	6200003950	S.COI HF50ACC 322513-T	B	33.2/17.2
L852	6200003950	S.COI HF50ACC 322513-T	B	35/21.3
L853	6200002041	S.COI NLV25T-101J	B	34.4/26.6
L854	6200002041	S.COI NLV25T-101J	B	34.4/24.1
L855	6200003950	S.COI HF50ACC 322513-T	B	36.4/17.2
R1	7030008141	S.RES ERA3YKD 224V (220K)	B	33.4/9.6
R2	7030005671	S.RES ERA3YKD 393V (39K)	B	33.4/11.6
R3	7030008051	S.RES ERA3YKD 184V (180K)	B	42.6/6.4
R4	7030005050	S.RES ERJ2GEJ 103 X (10K)	B	40.9/6.8
R5	7030005050	S.RES ERJ2GEJ 103 X (10K)	B	40.9/7.7
R51	7030008141	S.RES ERA3YKD 224V (220K)	B	49.7/10.8
R52	7030007911	S.RES ERA3YKD 563V (56K)	B	48.5/10.8
R53	7030006561	S.RES ERA3YED 223V (22K)	B	46.5/11.6
R54	7030005050	S.RES ERJ2GEJ 103 X (10K)	B	47.9/8.4
R55	7030005050	S.RES ERJ2GEJ 103 X (10K)	B	48.8/8.4
R201	7030010040	S.RES ERJ2GEJ-JPW	B	109.6/38
R202	7030010040	S.RES ERJ2GEJ-JPW	B	109.6/39
R251	7030005120	S.RES ERJ2GEJ 102 X (1K)	B	136.5/49.6
R252	7030000300	S.RES MCR10EZHJ 220 (221)	B	133.9/47.3
R253	7030000300	S.RES MCR10EZHJ 220 (221)	B	141.3/51.5
R254	7030000300	S.RES MCR10EZHJ 220 (221)	B	133.9/49
R255	7030000300	S.RES MCR10EZHJ 220 (221)	T	142.6/51.4
R301	7030005120	S.RES ERJ2GEJ 102 X (1K)	B	113.2/32
R302	7030005050	S.RES ERJ2GEJ 103 X (10K)	T	114/30.4
R303	7030005120	S.RES ERJ2GEJ 102 X (1K)	B	111/33.4
R304	7030007300	S.RES ERJ2GEJ 332 X (3.3K)	B	111.9/33.4
R305	7030007300	S.RES ERJ2GEJ 323 X (3.3K)	B	113.2/32.9
R306	7030005120	S.RES ERJ2GEJ 102 X (1K)	T	114.9/1.1
R307	7030005050	S.RES ERJ2GEJ 103 X (10K)	B	111.3/8.4
R308	7030005230	S.RES ERJ2GEJ 334 X (330K)	B	113.8/5.3
R309	7030005310	S.RES ERJ2GEJ 124 X (120K)	B	112/5.3
R310	7030008010	S.RES ERJ2GEJ 123 X (12K)	B	110.2/5.3
R521	7030008370	S.RES ERJ2GEJ 561 X (560)	B	61.8/46.2
R522	7030010040	S.RES ERJ2GEJ-JPW	B	65.3/47.4
R523	7030010040	S.RES ERJ2GEJ-JPW	B	65.4/48.7
R524	7030010900	S.RES ERJ3GEYJ 750 V (75)	B	63.1/48.9
R528	7030010040	S.RES ERJ2GEJ-JPW	B	60.8/42.6
R529	7030005050	S.RES ERJ2GEJ 103 X (10K)	B	58.6/43.8
R530	7030005080	S.RES ERJ2GEJ 823 X (82K)	B	60.8/43.6
R531	7030009290	S.RES ERJ2GEJ 562 X (5.6K)	B	76.3/42.9
R532	7030005050	S.RES ERJ2GEJ 103 X (10K)	B	60.8/37.2
R533	7030010040	S.RES ERJ2GEJ-JPW	B	56.5/32.3
R534	7030010040	S.RES ERJ2GEJ-JPW	B	60.8/36
R536	7030010040	S.RES ERJ2GEJ-JPW	B	62.6/29
R537	7030010040	S.RES ERJ2GEJ-JPW	B	64.6/29
R538	7030010040	S.RES ERJ2GEJ-JPW	B	66.6/29
R539	7030005720	S.RES ERJ2GEJ 563 X (56K)	B	69.6/29
R540	7030010040	S.RES ERJ2GEJ-JPW	B	68.6/29
R541	7310004650	S.TRI EVM-2WSX80 B53 (502)	B	53.3/49.2
R544	7030010040	S.RES ERJ2GEJ-JPW	B	60.8/39.6
R545	7030005720	S.RES ERJ2GEJ 563 X (56K)	B	60.8/32
R546	7030010040	S.RES ERJ2GEJ-JPW	B	60.8/34
R547	7030010040	S.RES ERJ2GEJ-JPW	B	59.2/34.8
R548	7030010040	S.RES ERJ2GEJ-JPW	B	60.8/33
R549	7030010040	S.RES ERJ2GEJ-JPW	B	63.6/29
R550	7030010040	S.RES ERJ2GEJ-JPW	B	65.6/29
R551	7030010040	S.RES ERJ2GEJ-JPW	B	67.6/29
R553	7030010040	S.RES ERJ2GEJ-JPW	B	59.5/43.8
R601	7030008410	S.RES ERJ2GEJ 392 X (3.9K)	B	72.7/24.9
R602	7030008410	S.RES ERJ2GEJ 392 X (3.9K)	B	74.5/24.9
R603	7030008410	S.RES ERJ2GEJ 392 X (3.9K)	B	75.4/24.9
R604	7030008410	S.RES ERJ2GEJ 392 X (3.9K)	B	77.2/24.9
R605	7030008410	S.RES ERJ2GEJ 392 X (3.9K)	B	75.3/30.2
R606	7030008410	S.RES ERJ2GEJ 392 X (3.9K)	B	76.3/24.9
R608	7030010040	S.RES ERJ2GEJ-JPW	B	48.8/36.8
R609	7030005040	S.RES ERJ2GEJ 472 X (4.7K)	B	48.4/44.4
R610	7030010040	S.RES ERJ2GEJ-JPW	B	48.8/41.7
R612	7030005040	S.RES ERJ2GEJ 472 X (4.7K)	B	48.8/42.6
R613	7030003470	S.RES ERJ3GEYJ 182 V (1.8K)	B	52.6/46.1
R614	7030003470	S.RES ERJ3GEYJ 182 V (1.8K)	B	50.7/46.3
R651	7030005050	S.RES ERJ2GEJ 103 X (10K)	B	5.5/19.6
R652	7030005220	S.RES ERJ2GEJ 223 X (22K)	B	0.81/25.7
R653	7030005060	S.RES ERJ2GEJ 333 X (33K)	B	5.5/21.4
R654	7030005070	S.RES ERJ2GEJ 683 X (68K)	B	0.81/23.9
R655	7030005090	S.RES ERJ2GEJ 104 X (100K)	B	4.1/30.7
R656	7030005110	S.RES ERJ2GEJ 224 X (220K)	B	0.81/27.4
R657	7030005060	S.RES ERJ2GEJ 333 X (33K)	B	1.8/30.3
R658	7030005090	S.RES ERJ2GEJ 104 X (100K)	B	4.1/29.8
R659	7030003600	S.RES ERJ3GEYJ 223 V (22K)	B	8.4/28.5
R660	7030005720	S.RES ERJ2GEJ 563 X (56K)	B	13.2/29.9
R661	7030005220	S.RES ERJ2GEJ 223 X (22K)	B	13.7/27.1
R662	7030007350	S.RES ERJ2GEJ 393 X (39K)	B	13.7/28.7
R663	7030005220	S.RES ERJ2GEJ 223 X (22K)	B	13.2/20.6
R664	7030007340	S.RES ERJ2GEJ 153 X (15K)	B	5.7/29.8
R665	7030003600	S.RES ERJ3GEYJ 223 V (22K)	B	8.9/20.6

[DISPLAY UNIT]

REF NO.	PARTS NO.	DESCRIPTION	M.	H/V LOCATION
R666	7030004980	S.RES ERJ2GEJ 101 X (100)	B	13.1/25.3
R667	7030004980	S.RES ERJ2GEJ 101 X (100)	B	11.1/18.8
R668	7030004980	S.RES ERJ2GEJ 101 X (100)	B	9.7/24.2
R669	7030004980	S.RES ERJ2GEJ 101 X (100)	B	13.6/16.2
R701	7030004990	S.RES ERJ2GEJ 221 X (220)	T	18.4/48
R702	7030007280	S.RES ERJ2GEJ 331 X (330)	T	19.7/48
R703	7030007290	S.RES ERJ2GEJ 222 X (2.2K)	T	25.1/41
R704	7030005040	S.RES ERJ2GEJ 472 X (4.7K)	T	16.6/17.2
R705	7030007340	S.RES ERJ2GEJ 153 X (15K)	T	18.7/6.4
R721	7030004990	S.RES ERJ2GEJ 221 X (220)	T	20.2/6.2
R722	7030007280	S.RES ERJ2GEJ 331 X (330)	T	23.8/5.6
R723	7030003480	S.RES ERJ3GEYJ 222 V (2.2K)	T	47.5/2.4
R724	7030003520	S.RES ERJ3GEYJ 472 V (4.7K)	T	61.8/2.4
R725	7030003580	S.RES ERJ3GEYJ 153 V (15K)	T	75.9/2.4
R741	7030004990	S.RES ERJ2GEJ 221 X (220)	T	92.2/49.7
R742	7030007280	S.RES ERJ2GEJ 331 X (330)	T	95.7/49.6
R743	7030007290	S.RES ERJ2GEJ 222 X (2.2K)	T	102.1/35
R744	7030005040	S.RES ERJ2GEJ 472 X (4.7K)	T	102.1/25.5
R745	7030007340	S.RES ERJ2GEJ 153 X (15K)	T	100.6/8.6
R761	7030004990	S.RES ERJ2GEJ 221 X (220)	T	103.1/48.2
R762	7030007280	S.RES ERJ2GEJ 331 X (330)	T	104.8/47.8
R771	7030004990	S.RES ERJ2GEJ 221 X (220)	T	18.7/28.9
R772	7030007280	S.RES ERJ2GEJ 331 X (330)	T	18.1/29.9
R781	7030004990	S.RES ERJ2GEJ 221 X (220)	T	3.5/22.4
R782	7030007280	S.RES ERJ2GEJ 331 X (330)	T	3.5/24.2
R801	7030005240	S.RES ERJ2GEJ 473 X (47K)	B	62/21.8
R802	7030007270	S.RES ERJ2GEJ 151 X (150)	B	62/20
R803	7030005120	S.RES ERJ2GEJ 102 X (1K)	B	62/23.6
R2002	7030005240	S.RES ERJ2GEJ 473 X (47K)	T	110.4/40.7
R2003	7030005050	S.RES ERJ2GEJ 103 X (10K)	T	24.6/24.1
R2004	7030005050	S.RES ERJ2GEJ 103 X (10K)	T	24.6/26.3
R2005	7030005050	S.RES ERJ2GEJ 103 X (10K)	T	24.6/23.2
R2006	7030005050	S.RES ERJ2GEJ 103 X (10K)	T	24.6/25.3
R2007	7030007290	S.RES ERJ2GEJ 222 X (2.2K)	T	107.6/24.4
R2008	7030005220	S.RES ERJ2GEJ 223 X (22K)	B	78.2/18.4
R2009	7030005240	S.RES ERJ2GEJ 473 X (47K)	T	107.8/33
R2010	7030005090	S.RES ERJ2GEJ 104 X (100K)	B	79.6/16.9
R2011	7030005160	S.RES ERJ2GEJ 105 X (1M)	B	103.3/26.9
R2012	7030008010	S.RES ERJ2GEJ 123 X (12K)	B	103.3/23.3
R2013	7030005240	S.RES ERJ2GEJ 473 X (47K)	B	96.7/37.9
R2014	7030005290	S.RES ERJ2GEJ 682 X (6.8K)	T	24.1/41
R2015	7030005050	S.RES ERJ2GEJ 103 X (10K)	B	106/44.6
R2016	7030005240	S.RES ERJ2GEJ 473 X (47K)	B	92.1/37.9
R2017	7030005290	S.RES ERJ2GEJ 682 X (6.8K)	T	33.4/3.7
R2018	7030005290	S.RES ERJ2GEJ 682 X (6.8K)	T	102.2/41.8
R2019	7030005240	S.RES ERJ2GEJ 473 X (47K)	B	84.8/33.8
R2020	7030003450	S.RES ERJ3GEYJ 122 V (1.2K)	B	91.2/43.1
R2021	7030005240	S.RES ERJ2GEJ 473 X (47K)	B	97.1/40.8
R2022	7030005240	S.RES ERJ2GEJ 473 X (47K)	B	92.3/42.3
R2023	7030005240	S.RES ERJ2GEJ 473 X (47K)	B	100.1/42.8
R2024	7030005240	S.RES ERJ2GEJ 473 X (47K)	B	94.3/42.3
R2025	7030005240	S.RES ERJ2GEJ 473 X (47K)	B	93.3/42.3
R2026	7030005240	S.RES ERJ2GEJ 473 X (47K)	B	72.4/16.7
R2027	7030005240	S.RES ERJ2GEJ 473 X (47K)	B	70.6/16.9
R2028	7030005240	S.RES ERJ2GEJ 473 X (47K)	B	98.9/42.8
R2029	7030005240	S.RES ERJ2GEJ 473 X (47K)	B	73.5/16.7
R2030	7030007270	S.RES ERJ2GEJ 151 X (150)	T	108/11.8
R2031	7030007280	S.RES ERJ2GEJ 331 X (330)	T	108.8/40.1
R2033	7030007270	S.RES ERJ2GEJ 151 X (150)	T	19.4/20.3
R2034	7030005120	S.RES ERJ2GEJ 102 X (1K)	B	32.1/28.3
R2035	7030005120	S.RES ERJ2GEJ 102 X (1K)	B	32.5/30.9
R2036	7030005240	S.RES ERJ2GEJ 473 X (47K)	B	94.9/37.9
R2037	7030005240	S.RES ERJ2GEJ 473 X (47K)	B	93.9/37.9
R2039	7030005240	S.RES ERJ2GEJ 473 X (47K)	T	107.6/23.5
R2040	7030007340	S.RES ERJ2GEJ 153 X (15K)	B	116.3/8.7
R2041	7030007340	S.RES ERJ2GEJ 153 X (15K)	B	116.2/7.7
R2042	7030005050	S.RES ERJ2GEJ 103 X (10K)	B	79.7/31.3
R2043	7030005090	S.RES ERJ2GEJ 104 X (100K)	B	81.9/30.4
C2	4030018960	S.CER C3216 JB 1C 106MT-N	B	62.2/7
C3	4030018960	S.CER C3216 JB 1C 106MT-N	B	77/9.8
C4	4030017420	S.CER ECJ0EC1H470J	B	35.3/10.6
C6	4030018960	S.CER C3216 JB 1C 106MT-N	B	28/6
C8	4030018960	S.CER C3216 JB 1C 106MT-N	B	30.1/6
C9	4030018960	S.CER C3216 JB 1C 106MT-N	B	39.1/4.4
C51	4030017420	S.CER ECJ0EC1H470J	B	49.7/8.4
C53	4030018960	S.CER C3216 JB 1C 106MT-N	B	51.6/4.3
C55	4030018960	S.CER C3216 JB 1C 106MT-N	B	56.2/1.1
C56	4030018960	S.CER C3216 JB 1C 106MT-N	B	61.9/3.6
C57	4030017490	S.CER C1608 JB 1A 105K-T	B	43.9/11.8
C101	4030018960	S.CER C3216 JB 1C 106MT-N	B	85.7/6.3
C102	4030018960	S.CER C3216 JB 1C 106MT-N	B	94.7/4.6
C103	4030016930	S.CER ECJ0EB1A104K	B	91.1/12.2
C104	4030016930	S.CER ECJ0EB1A104K	B	89.5/12.2
C151	4550006250	S.TAN TEESVA 1A 106M8R	B	97/4.6
C152	4550006250	S.TAN TEESVA 1A 106M8R	B	100.7/7.7
C153	4030016930	S.CER ECJ0EB1A104K	B	99.7/2.6
C154	4030016930	S.CER ECJ0EB1A104K	B	99.6/9.3
C251	4030017730	S.CER ECJ0EB1E471K	B	

[DISPLAY UNIT]

REF NO.	PARTS NO.	DESCRIPTION	M.	H/V LOCATION
C304	4030017780	S.CER ECJ0EB1E472K	B	113.2/33.8
C305	4030017780	S.CER ECJ0EB1E472K	T	114.9/12.6
C306	4030017780	S.CER ECJ0EB1E472K	B	113.8/4.3
C312	4030017780	S.CER ECJ0EB1E472K	T	108.2/29.6
C315	4030017780	S.CER ECJ0EB1E472K	B	25.2/19.9
C316	4030017780	S.CER ECJ0EB1E472K	B	26.1/19.9
C317	4030017780	S.CER ECJ0EB1E472K	B	27/19.9
C318	4030017780	S.CER ECJ0EB1E472K	B	23.9/19.8
C319	4030017780	S.CER ECJ0EB1E472K	B	27.2/32.5
C320	4030017780	S.CER ECJ0EB1E472K	B	26.3/32.5
C321	4030017780	S.CER ECJ0EB1E472K	B	25.5/31.1
C322	4030017780	S.CER ECJ0EB1E472K	T	24.6/27.3
C501	4550007140	S.TAN TEESVD 1C 107M12R	B	53.3/20.9
C502	4550007140	S.TAN TEESVD 1C 107M12R	B	45.3/20.9
C513	4030016930	S.CER ECJ0EB1A104K	B	64.3/47.4
C514	4030016930	S.CER ECJ0EB1A104K	B	63.3/47.4
C515	4030017490	S.CER C1608 JB 1A 105K-T	B	61.5/44.9
C516	4030018910	S.CER C1608 JB 0J 475K-T	B	67.7/48.9
C517	4030017490	S.CER C1608 JB 1A 105K-T	B	75.6/47.9
C518	4030017650	S.CER ECJ0EC1H270J	[EUR] B	73.4/47.4
	4030017650	S.CER ECJ0EC1H270J	[FRA]	
	4030017650	S.CER ECJ0EC1H270J	[ESP]	
	4030017670	S.CER ECJ0EC1H390J	[USA]	
	4030017650	S.CER ECJ0EC1H270J	[EXP]	
	4030017650	S.CER ECJ0EC1H270J	[ITR]	
	4030017650	S.CER ECJ0EC1H270J	[UK]	
	4030017670	S.CER ECJ0EC1H390J	[KOR]	
	4030017650	S.CER ECJ0EC1H270J	[AUS]	
	4030017650	S.CER ECJ0EC1H270J	[CHN]	
C519	4030016930	S.CER ECJ0EB1A104K	B	76.9/48.4
C520	4030016930	S.CER ECJ0EB1A104K	B	74.4/47.4
C521	4030018960	S.CER C3216 JB 1C 106MT-N	B	65.6/20.6
C522	4030016930	S.CER ECJ0EB1A104K	B	69.7/19.8
C523	4030018970	S.CER C3225 JB 1C 226MT-N	B	53.4/28.9
C524	4030017700	S.CER ECJ0EC1H151J	B	59/42.6
C525	4030016930	S.CER ECJ0EB1A104K	B	55.4/30.3
C526	4030018090	S.CER ECJ0EB1C822K	B	59.2/35.8
C527	4030018100	S.CER ECJ0EB1H681K	B	59/45.9
C528	4030017730	S.CER ECJ0EB1E471K	B	59/45
C529	4030018970	S.CER C3225 JB 1C 226MT-N	B	58.4/40
C530	4030016930	S.CER ECJ0EB1A104K	B	77.2/39.1
C531	4030018970	S.CER C3225 JB 1C 226MT-N	B	81.3/35.9
C532	4030016930	S.CER ECJ0EB1A104K	B	77.2/36.6
C533	4030017490	S.CER C1608 JB 1A 105K-T	B	77/44.5
C534	4030016970	S.CER ECJ0EB1C223K	B	77.5/42.5
C536	4610001850	S.TRI TZB4R200AB10R00 (TZBX4R200BA110)	B	81/39.7
C537	4030016930	S.CER ECJ0EB1A104K	B	77.2/40.1
C538	4030016930	S.CER ECJ0EB1A104K	B	77.2/37.6
C539	4030018910	S.CER C1608 JB 0J 475K-T	B	77.7/34.9
C540	4030018910	S.CER C1608 JB 0J 475K-T	B	58.5/37
C541	4030018970	S.CER C3225 JB 1C 226MT-N	B	59.2/28.9
C542	4030018910	S.CER C1608 JB 0J 475K-T	B	77.7/33.6
C543	4030018960	S.CER C3216 JB 1C 106MT-N	B	80/46.5
C544	4030018910	S.CER C1608 JB 0J 475K-T	B	77.7/32.3
C545	4030011600	S.CER C1608 JB 1E 104K-T	B	77/46.3
C549	4030018960	S.CER C3216 JB 1C 106MT-N	B	71.7/28.8
C550	4030018960	S.CER C3216 JB 1C 106MT-N	B	77/28.8
C551	4030018960	S.CER C3216 JB 1C 106MT-N	B	73.8/28.8
C559	4030017460	S.CER ECJ0EB1E102K	B	29.3/43.9
C560	4030018960	S.CER C3216 JB 1C 106MT-N	B	17/33.2
C561	4030017330	S.CER ECJ0EF1C104Z	B	7.3/30.7
C562	4030017780	S.CER ECJ0EB1E472K	B	6.1/30.9
C601	4030016930	S.CER ECJ0EB1A104K	B	73.6/24.9
C602	4030016930	S.CER ECJ0EB1A104K	B	48.8/43.5
C603	4030016930	S.CER ECJ0EB1A104K	B	55/39.4
C604	4030018960	S.CER C3216 JB 1C 106MT-N	B	55.8/36.3
C605	4030016930	S.CER ECJ0EB1A104K	B	50.9/48
C606	4030018960	S.CER C3216 JB 1C 106MT-N	B	49/47.4
C607	4030011600	S.CER C1608 JB 1E 104K-T	B	55.4/40.6
C608	4030018960	S.CER C3216 JB 1C 106MT-N	B	55.8/43.7
C609	4030011600	S.CER C1608 JB 1E 104K-T	B	50.6/31.7
C610	4030018960	S.CER C3216 JB 1C 106MT-N	B	52.3/33.5
C611	4550007220	S.TAN F931A476MCMCMBMA	B	73.4/22.1
C651	4030018960	S.CER C3216 JB 1C 106MT-N	B	16.9/17.6
C652	4030018960	S.CER C3216 JB 1C 106MT-N	B	6.7/17.1
C653	4030011600	S.CER C1608 JB 1E 104K-T	B	15.7/19.3
C654	4030017490	S.CER C1608 JB 1A 105K-T	B	3.5/20.4
C655	4030016790	S.CER ECJ0EB1C103K	B	0.8/30.3
C656	4030019090	S.CER C2012 JB 1C 225M-T	B	7.8/25.5
C657	4030018520	S.CER C1608 JB 0J 225M-T	B	7/20.6
C658	4030017650	S.CER ECJ0EC1H270J	B	5.5/20.5
C659	4030017780	S.CER ECJ0EB1E472K	B	15.2/20.3
C701	4030018960	S.CER C3216 JB 1C 106MT-N	B	4.6/32.4
C702	4030018960	S.CER C3216 JB 1C 106MT-N	B	48.9/19
C801	4030016930	S.CER ECJ0EB1A104K	B	62.9/19.7
C802	4030011600	S.CER C1608 JB 1E 104K-T	B	21.5/48.5
C851	4030017780	S.CER ECJ0EB1E472K	B	32.1/23.9
C852	4030018960	S.CER C3216 JB 1C 106MT-N	B	40.3/15.8
C853	4030016930	S.CER ECJ0EB1A104K	B	43.1/27.5
C2001	4030018520	S.CER C1608 JB 0J 225M-T	B	78.5/16.7
C2002	4030017780	S.CER ECJ0EB1E472K	T	114.8/34.7
C2003	4030017630	S.CER ECJ0EC1H120J	B	103.3/28.7
C2004	4030017630	S.CER ECJ0EC1H120J	B	103.3/25.1
C2005	4030016790	S.CER ECJ0EB1C103K	B	103.2/34.9
C2006	4030016930	S.CER ECJ0EB1A104K	B	98/37.9
C2007	4030018960	S.CER C3216 JB 1C 106MT-N	B	105.8/47.7
C2008	4030017030	S.CER ECJ0EB1A273K	B	109.7/44.6

[DISPLAY UNIT]

REF NO.	PARTS NO.	DESCRIPTION	M.	H/V LOCATION
C2009	4030016930	S.CER ECJ0EB1A104K	B	99/37.9
C2010	4030016930	S.CER ECJ0EB1A104K	B	100/37.9
C2011	4030016930	S.CER ECJ0EB1A104K	B	78.7/29.9
C2012	4030017780	S.CER ECJ0EB1E472K	B	95.8/37.9
C2013	4030017780	S.CER ECJ0EB1E472K	B	93/37.9
C2014	4030016930	S.CER ECJ0EB1A104K	T	110.4/41.7
C2015	4030016930	S.CER ECJ0EB1A104K	B	103.1/35.8
C2016	4030016930	S.CER ECJ0EB1A104K	B	82.7/28.4
J202	6510023801	S.CON S4B-ZR-SM4A-TF(LF)(SN)	B	115.9/39.4
J251	6510025770	S.CON 03-935H0-72BKA	B	154.2/45.8
J303	6510021431	S.CON S8B-ZR-SM4A-TF(LF)(SN)	B	115.9/20.9
J401	6510024840	S.CON 52746-1070	B	21.3/26.3
J601	6510024780	S.CON 52437-2472	B	45.1/42
J2001	6510022490	S.CON 52559-1072	B	96.9/47.6
DS805	5040003190	S.LED NSSW008B	T	29.5/39.4
DS806	5040003190	S.LED NSSW008B	T	29.4/31.4
DS807	5040003190	S.LED NSSW008B	T	29.4/24.1
DS808	5040003190	S.LED NSSW008B	T	29.5/16.1
DS2001	5040002930	S.LED SML-512MW T86	T	110.2/15.8
DS2002	5040002200	S.LED CL-170UR-CD-T	T	110.2/36.8
DS2004	5040002930	S.LED SML-512MW T86	T	11.4/20.5
S201	2230001160	S.SWI SPVP110100	T	157.4/34.3
S251	2220000330	S.SWI HSW0880-01-210	B	139.7/46.5
S701	2230001150	S.SWI LS9J2M-1FG-T	T	22.2/48.3
S702	2230001150	S.SWI LS9J2M-1FG-T	T	21.7/36.5
S703	2230001150	S.SWI LS9J2M-1FG-T	T	20.9/17
S704	2230001150	S.SWI LS9J2M-1FG-T	T	21.6/2.7
S721	2230001150	S.SWI LS9J2M-1FG-T	T	40.1/2.4
S722	2230001150	S.SWI LS9J2M-1FG-T	T	54.3/2.4
S723	2230001150	S.SWI LS9J2M-1FG-T	T	68.4/2.4
S724	2230001150	S.SWI LS9J2M-1FG-T	T	82.6/2.4
S741	2230001150	S.SWI LS9J2M-1FG-T	T	98.1/47.8
S742	2230001150	S.SWI LS9J2M-1FG-T	T	99.1/32.1
S743	2230001150	S.SWI LS9J2M-1FG-T	T	99.1/20.5
S744	2230001150	S.SWI LS9J2M-1FG-T	T	98.1/5.7
S761	2230001150	S.SWI LS9J2M-1FG-T	T	109.5/49.1
S762	2230001150	S.SWI LS9J2M-1FG-T	T	109.5/3.5
S763	2230001150	S.SWI LS9J2M-1FG-T	T	154.8/47.4
S764	2230001150	S.SWI LS9J2M-1FG-T	T	154.8/5.1
S781	2230001150	S.SWI LS9J2M-1FG-T	T	4.6/29
S782	2230001150	S.SWI LS9J2M-1FG-T	T	21.7/25.8
EP1	6910014730	S.BEA MPZ2012S331A-T	B	64.1/6.6

M.=Mounted side (T: Mounted on the Top side, B: Mounted on the Bottom side)
S.=Surface mount

[VR UNIT]

REF NO.	PARTS NO.	DESCRIPTION	M.	H/V LOCATION
R1	7210003230	VAR TP96D00A-17F-10KBX2-2427	T	1.3/32.6
R2	7030003860	S.RES ERJ3GE JPW V	T	2.3/30
R3	7030003860	S.RES ERJ3GE JPW V	T	
J1	6510024850	S.CON 54550-1094	T	3.3/22.2
S1	2250000170	ENC TP90D96AE20-17F (1352)		
EP4	6910012350	S.BEA MMZ1608Y 102BT	T	2.7/32.6
EP5	6910012350	S.BEA MMZ1608Y 102BT	T	3.7/30
EP6	6910012350	S.BEA MMZ1608Y 102BT	T	.9/30
EP7	6910012350	S.BEA MMZ1608Y 102BT	T	.9/14.5
EP8	6910012350	S.BEA MMZ1608Y 102BT	T	3.7/14.5
EP9	6910012350	S.BEA MMZ1608Y 102BT	T	2.7/11.8
EP10	6910012350	S.BEA MMZ1608Y 102BT	T	2.3/14.5
EP11	6910012350	S.BEA MMZ1608Y 102BT	T	1.3/11.8

[LOGIC UNIT]

REF NO.	PARTS NO.	DESCRIPTION	M.	H/V LOCATION
IC1	1130013281	S.IC TC58FVM6T5BTG65GCH (2427D-6)	T	27.9/30.2
IC2	1130011151	S.IC SN74AHC2G08HDCT3	B	40.2/38.2
IC3	1130011151	S.IC SN74AHC2G08HDCT3	B	40.6/32.4
IC4	1130012600	S.IC SN74AHC1G04DCKR	B	43.6/33.8
IC51	1130012842	S.IC CY7C1021DV33-10BVXIT	B	24.5/28.5
IC301	1140012541	S.IC ADSP-BF532SBBCZ400 <FE>	B	28.6/39.2
IC401	1110004770	S.IC BU9480F-E2	B	17.4/21.6
IC451	1110006570	S.IC TS462CPT	B	29.1/7.9
IC452	1110006570	S.IC TS462CPT	T	39.1/8.5
IC502	1110006570	S.IC TS462CPT	T	30.7/5.4
IC551	1190001611	S.IC AK4528VFP-E2/P	T	17.9/8.1
IC601	1110006570	S.IC TS462CPT	B	12.7/10.8
IC701	1130012600	S.IC SN74AHC1G04DCKR	B	2.7/15.9
IC1201	1130012791	S.IC CY22150FZXCT	B	44.5/4.5
IC1212	1140012170	S.IC BH7236AF-E2	T	57.7/7.3
IC1217	1130007181	S.IC TC7WU04FU(TE12L,F)	B	63.4/9.8
IC1218	1130012761	S.IC SN74AHC2G86HDCT3	B	52.7/6.5
IC1226	1130010871	S.IC S1D13706F00A200	B	53.7/19.8
IC1251	1180002020	S.REG BA033FP-E2	T	79.5/5.2
IC1301	1130012691	S.IC R1EX24256ASA00A	T	81.4/36.2
IC1302	1140013137	S.IC HD6432375A23FQV (SX-2427B-7)	T	54.9/25.2
IC1303	1110005771	S.IC S-80942CNMC-G9CT2G	T	81.2/10.4
IC1304	1130011551	S.IC RX-4581NB-F	B	71.9/7.2
IC1402	1130012781	S.IC SN74AHC2G04HDCT3	T	79.1/18.9
IC2002	1130012842	S.IC CY7C1021DV33-10BVXIT	B	32.7/28.3
IC2101	1130012850	S.IC SN74LVC3G34DCUR	T	44.5/44.7
IC2102	1130012850	S.IC SN74LVC3G34DCUR	T	44.4/41.2
IC2201	1140012541	S.IC ADSP-BF532SBBCZ400 <FE>	B	28.6/17.7
Q201	1550000110	S.FET RTQ035P02TR	B	18.9/42.7
Q1101	1530002060	S.TRA 2SC4081 T106 R	T	82.1/20.3
Q1102	1590003940	S.TRA RN1105(TE85L,F)	T	81.8/22.7
Q1103	1510000510	S.TRA 2SA1576A T106R	T	81.8/16.4
Q1201	1590003940	S.TRA RN1105(TE85L,F)	T	44.8/13.2
D201	1750001280	S.DIO CUS02(TE85L,Q)	B	19.2/45.3
D1001	1750000370	S.DIO DA221 TL	B	64.5/36.8
D1002	1750000370	S.DIO DA221 TL	B	64.9/34.5
D1101	1790001251	S.DIO MA2S1110GL	T	81.9/18.4
D1106	1750000951	S.DIO MA2J7320GL	T	80.1/29.6
D1107	1790001670	S.DIO RB706F-40T106	T	82.4/31.3
D1110	1790001670	S.DIO RB706F-40T106	T	75.7/32.3
D1111	1790001670	S.DIO RB706F-40T106	T	75.3/29.3
D1112	1790001670	S.DIO RB706F-40T106	B	79.2/29.1
D1113	1790001670	S.DIO RB706F-40T106	B	82.3/30.6
D1201	1790001251	S.DIO MA2S1110GL	B	83/40.4
D1301	1790000661	S.DIO MA2J7280GL	B	77.5/2.9
D1304	1750000370	S.DIO DA221 TL	T	76.1/19.9
D1305	1750000370	S.DIO DA221 TL	T	75.8/16.8
D1306	1750000370	S.DIO DA221 TL	B	49.3/32.9
D1307	1750000370	S.DIO DA221 TL	B	51.4/33.3
D1311	1790001251	S.DIO MA2S1110GL	B	80.9/19.6
D1312	1790001251	S.DIO MA2S1110GL	B	83.1/18.5
D1313	1790001251	S.DIO MA2S1110GL	B	80/22.6
D1314	1790001241	S.DIO MA2S7280GL	B	81.7/22.4
D1331	1790001251	S.DIO MA2S1110GL	B	65.6/17.5
X1201	6050012150	S.XTA CR-806 SMD-49TA 4.433619 MHz <KDS> [EUR]	B	61.3/3.1
	6050012150	S.XTA CR-806 SMD-49TA 4.433619 MHz <KDS> [FRA]		
	6050012150	S.XTA CR-806 SMD-49TA 4.433619 MHz <KDS> [ESP]		
	6050012140	S.XTA CR-805 SMD-49TA 3.579545 MHz <KDS> [USA]		
	6050012150	S.XTA CR-806 SMD-49TA 4.433619 MHz <KDS> [EXP]		
	6050012150	S.XTA CR-806 SMD-49TA 4.433619 MHz <KDS> [ITR]		
	6050012150	S.XTA CR-806 SMD-49TA 4.433619 MHz <KDS> [UK]		
	6050012140	S.XTA CR-805 SMD-49TA 3.579545 MHz <KDS> [KOR]		
	6050012150	S.XTA CR-806 SMD-49TA 4.433619 MHz <KDS> [AUS]		
	6050012150	S.XTA CR-806 SMD-49TA 4.433619 MHz <KDS> [CHN]		
X1301	6050012190	S.XTA CR-809 SMD-49TA 1539744 MHz <KDS>	B	60.4/30.8
L201	6200011900	S.COI LQH43CN100K03L	T	16/41.9
L202	6200009491	S.COI CDRH6D28NP-100NCI	B	13.3/42.3
L551	6200005011	S.COI NLV25T-100J	T	11.2/10.5
L552	6200005011	S.COI NLV25T-100J	T	11.1/5.8
L1202	6200002041	S.COI NLV25T-101J	B	52.3/2.3
L1203	6200002041	S.COI NLV25T-101J	T	66.7/3.5
L1204	6200002041	S.COI NLV25T-101J	B	57.9/10.3
L2101	6200005011	S.COI NLV25T-100J	T	40.9/45
L2102	6200005011	S.COI NLV25T-100J	T	40.2/41.5
R2	7030005090	S.RES ERJ2GEJ 104 X (100K)	T	39.5/30.1

M.=Mounted side (T: Mounted on the Top side, B: Mounted on the Bottom side)
S.=Surface mount

[LOGIC UNIT]

REF NO.	PARTS NO.	DESCRIPTION	M.	H/V LOCATION
R3	7030005090	S.RES ERJ2GEJ 104 X (100K)	T	39.5/32.3
R4	7030005090	S.RES ERJ2GEJ 104 X (100K)	T	31.8/45.8
R5	7030005090	S.RES ERJ2GEJ 104 X (100K)	T	30.9/45.8
R6	7030005090	S.RES ERJ2GEJ 104 X (100K)	T	30/45.8
R203	7030000010	S.RES MCR10EZHJ JPW (000)	T	20.7/45.6
R301	7030004980	S.RES ERJ2GEJ 101 X (100)	T	25.4/45.8
R302	7030005050	S.RES ERJ2GEJ 103 X (10K)	T	26.9/45.8
R303	7030005050	S.RES ERJ2GEJ 103 X (10K)	T	27.8/45.8
R306	7030005050	S.RES ERJ2GEJ 103 X (10K)	B	38.1/31.1
R307	7030005050	S.RES ERJ2GEJ 103 X (10K)	T	22/41.4
R308	7030005050	S.RES ERJ2GEJ 103 X (10K)	T	22/40.5
R310	7030005050	S.RES ERJ2GEJ 103 X (10K)	B	35.3/38
R312	7030010040	S.RES ERJ2GEJ-JPW	B	33.6/45.9
R313	7030010040	S.RES ERJ2GEJ-JPW	B	35.6/43.3
R314	7030010040	S.RES ERJ2GEJ-JPW	B	35.6/40.6
R413	7030004980	S.RES ERJ2GEJ 101 X (100)	B	18.1/16.8
R414	7030004980	S.RES ERJ2GEJ 101 X (100)	T	16.3/19.9
R415	7030004980	S.RES ERJ2GEJ 101 X (100)	B	19/16.8
R416	7030004980	S.RES ERJ2GEJ 101 X (100)	B	17.2/16.8
R462	7030004980	S.RES ERJ2GEJ 101 X (100)	B	33.8/7.4
R463	7030004980	S.RES ERJ2GEJ 101 X (100)	T	43.6/8.8
R464	7030004980	S.RES ERJ2GEJ 101 X (100)	B	26.2/5.7
R465	7030009270	S.RES ERJ2GEJ 821 X (820)	B	28.6/5.2
R467	7030004980	S.RES ERJ2GEJ 101 X (100)	B	31.3/4.3
R469	7030009270	S.RES ERJ2GEJ 821 X (820)	B	30.4/4.3
R470	7030009140	S.RES ERJ2GEJ 272 X (2.7K)	T	29.4/3
R471	7030009140	S.RES ERJ2GEJ 272 X (2.7K)	T	34/3.3
R472	7030005040	S.RES ERJ2GEJ 472 X (4.7K)	T	38.6/4.2
R473	7030005040	S.RES ERJ2GEJ 472 X (4.7K)	T	38.6/3.2
R474	7030009140	S.RES ERJ2GEJ 272 X (2.7K)	B	24.8/7.1
R475	7030009140	S.RES ERJ2GEJ 272 X (2.7K)	B	33.8/9.2
R476	7030005040	S.RES ERJ2GEJ 472 X (4.7K)	T	40.2/3.3
R507	7030004980	S.RES ERJ2GEJ 101 X (100)	T	26/3.5
R508	7030004980	S.RES ERJ2GEJ 101 X (100)	T	31.6/8.9
R510	7030005040	S.RES ERJ2GEJ 472 X (4.7K)	T	32.5/8.9
R511	7030005040	S.RES ERJ2GEJ 472 X (4.7K)	T	28.9/8.9
R512	7030004980	S.RES ERJ2GEJ 101 X (100)	T	29.8/8.9
R514	7030005050	S.RES ERJ2GEJ 103 X (10K)	T	34.9/8.8
R515	7030005050	S.RES ERJ2GEJ 103 X (10K)	T	34.9/7.9
R516	7030005040	S.RES ERJ2GEJ 472 X (4.7K)	T	39/12.8
R517	7030005040	S.RES ERJ2GEJ 472 X (4.7K)	T	36.5/11
R518	7030009140	S.RES ERJ2GEJ 272 X (2.7K)	T	26.4/5.6
R519	7030009140	S.RES ERJ2GEJ 272 X (2.7K)	T	26.4/5.6
R520	7030005040	S.RES ERJ2GEJ 472 X (4.7K)	T	41.3/12.8
R551	7030004980	S.RES ERJ2GEJ 101 X (100)	T	16.5/13.4
R553	7030004980	S.RES ERJ2GEJ 101 X (100)	T	14.7/13.4
R554	7030005090	S.RES ERJ2GEJ 104 X (100K)	T	15.4/3.2
R568	7030004980	S.RES ERJ2GEJ 101 X (100)	T	12.9/13.4
R569	7030004980	S.RES ERJ2GEJ 101 X (100)	T	15.6/13.4
R570	7030004980	S.RES ERJ2GEJ 101 X (100)	T	13.8/13.4
R571	7030009320	S.RES ERJ2GEJ 4R7 X (4.7)	B	20.7/8.4
R601	7030004980	S.RES ERJ2GEJ 101 X (100)	T	3/12.3
R602	7030007300	S.RES ERJ2GEJ 332 X (3.3K)	T	11.8/8.4
R603	7030005040	S.RES ERJ2GEJ 472 X (4.7K)	B	12.3/4.8
R604	7030005040	S.RES ERJ2GEJ 472 X (4.7K)	B	13.2/4.8
R605	7030007300	S.RES ERJ2GEJ 332 X (3.3K)	B	14.4/5.1
R606	7030007300	S.RES ERJ2GEJ 332 X (3.3K)	B	12.8/7.2
R607	7030005290	S.RES ERJ2GEJ 682 X (6.8K)	B	13.8/7.2
R608	7030005290	S.RES ERJ2GEJ 682 X (6.8K)	B	14.8/6.4
R609	7030005040	S.RES ERJ2GEJ 472 X (4.7K)	T	10.9/8.4
R610	7030005040	S.RES ERJ2GEJ 472 X (4.7K)	B	8.9/4.2
R611	7030005040	S.RES ERJ2GEJ 472 X (4.7K)	B	9.8/4.2
R612	7030007300	S.RES ERJ2GEJ 332 X (3.3K)	B	11.4/5.6
R613	7030007300	S.RES ERJ2GEJ 332 X (3.3K)	B	8.8/6.9
R614	7030005290	S.RES ERJ2GEJ 682 X (6.8K)	B	9.7/6.9
R615	7030005290	S.RES ERJ2GEJ 682 X (6.8K)	B	10.6/6.9
R618	7030005120	S.RES ERJ2GEJ 102 X (1K)	B	14.4/4.2
R619	7030005120	S.RES ERJ2GEJ 102 X (1K)	B	10.7/4.2
R701	7030005050	S.RES ERJ2GEJ 103 X (10K)	B	4.6/22.8
R702	7030005050	S.RES ERJ2GEJ 103 X (10K)	B	4.6/23.7
R703	7030005050	S.RES ERJ2GEJ 103 X (10K)	B	4.5/25.9
R705	7030005120	S.RES ERJ2GEJ 102 X (1K)	B	5/21
R706	7030005050	S.RES ERJ2GEJ 103 X (10K)	B	4.4/17.1
R707	7030007250	S.RES ERJ2GEJ 220 X (22)	B	4.4/15.5
R1001	7030005120	S.RES ERJ2GEJ 102 X (1K)	B	70.8/37
R1002	7030005050	S.RES ERJ2GEJ 103 X (10K)	B	65.9/32.3
R1003	7030005160	S.RES ERJ2GEJ 105 X (1M)	B	70.4/35.8
R1004	7030005240	S.RES ERJ2GEJ 473 X (47K)	B	66.1/18.5
R1006	7030005120	S.RES ERJ2GEJ 102 X (1K)	B	52/34.8
R1007	7030005120	S.RES ERJ2GEJ 102 X (1K)	B	53.2/32
R1008	7030005120	S.RES ERJ2GEJ 102 X (1K)	B	75.1/20.4
R1010	7030005240	S.RES ERJ2GEJ 473 X (47K)	B	76.7/19.8
R1012	7030005000	S.RES ERJ2GEJ 471 X (470)	B	66.5/33.9
R1013	7030005000	S.RES ERJ2GEJ 471 X (470)	B	66.5/36.4
R1015	7030005240	S.RES ERJ2GEJ 473 X (47K)	B	50.4/34.8
R1016	7030005240	S.RES ERJ2GEJ 473 X (47K)	B	51/31.7
R1018	7030007340	S.RES ERJ2GEJ 153 X (15K)	B	63.3/34.4
R1019	7030007340	S.RES ERJ2GEJ 153 X (15K)	B	62.9/36.1
R1101	7030008290	S.RES ERJ2GEJ 183 X (18K)	T	80.1/15.4
R1102	7030008010	S.RES ERJ2GEJ 123 X (12K)	T	79.9/21.9
R1103	7030005120	S.RES ERJ2GEJ 102 X (1K)	T	79.9/22.8
R1104	7030005120	S.RES ERJ2GEJ 102 X (1K)	T	74.5/20.7
R1105	7030005050	S.RES ERJ2GEJ 103 X (10K)	T	79.6/14.2
R1106	7030005240	S.RES ERJ2GEJ 473 X (47K)	T	83.3/14.4
R1107	7030005090	S.RES ERJ2GEJ 104 X (100K)	T	79.2/15.4
R1108	7030005090	S.RES ERJ2GEJ 104 X (100K)	T	78.3/14.8
R1109	7030005160	S.RES ERJ2GEJ 105 X (1M)	T	78.3/21.9
R1110	7030005240	S.RES ERJ2GEJ 473 X (47K)	T	76.7/21.4

[LOGIC UNIT]

REF NO.	PARTS NO.	DESCRIPTION	M.	H/V LOCATION
R1111	7030005090	S.RES ERJ2GEJ 104 X (100K)	T	77.4/14.8
R1113	7030007290	S.RES ERJ2GEJ 22 X (2.2K)	T	83.2/29.3
R1114	7030007300	S.RES ERJ2GEJ 332 X (3.3K)	T	82.3/29.3
R1115	7030005120	S.RES ERJ2GEJ 102 X (1K)	T	76.8/26.3
R1116	7030005120	S.RES ERJ2GEJ 102 X (1K)	T	76.9/28.1
R1117	7030005120	S.RES ERJ2GEJ 102 X (1K)	B	82.7/22.2
R1118	7030007300	S.RES ERJ2GEJ 332 X (3.3K)	B	83/23.8
R1119	7030007300	S.RES ERJ2GEJ 332 X (3.3K)	B	83.8/22.8
R1120	7030005120	S.RES ERJ2GEJ 102 X (1K)	B	84.1/23.8
R1123	7030005160	S.RES ERJ2GEJ 105 X (1M)	B	66.9/24.4
R1124	7030005120	S.RES ERJ2GEJ 102 X (1K)	B	82/20
R1126	7030005160	S.RES ERJ2GEJ 105 X (1M)	B	66.9/23.5
R1127	7030010040	S.RES ERJ2GEJ-JPW	T	73.7/18.5
R1128	7030005120	S.RES ERJ2GEJ 102 X (1K)	B	83.2/20.1
R1129	7030007300	S.RES ERJ2GEJ 332 X (3.3K)	B	81.9/28.4
R1131	7030005090	S.RES ERJ2GEJ 104 X (100K)	B	78.5/26.1
R1132	7030005090	S.RES ERJ2GEJ 104 X (100K)	B	81.4/24.4
R1201	7030005160	S.RES ERJ2GEJ 105 X (1M)	B	62.7/7.6
R1202	7030005050	S.RES ERJ2GEJ 103 X (10K)	B	49.2/7.5
R1203	7030005050	S.RES ERJ2GEJ 103 X (10K)	B	49.2/8.4
R1204	7030005050	S.RES ERJ2GEJ 103 X (10K)	B	49.7/9.6
R1205	7030010040	S.RES ERJ2GEJ-JPW	B	49.2/3.1
R1206	7030007570	S.RES ERJ2GEJ 122 X (1.2K)	B	46.1/9.6
R1207	7030007570	S.RES ERJ2GEJ 122 X (1.2K)	B	43.9/9.6
R1208	7030007570	S.RES ERJ2GEJ 122 X (1.2K)	B	43.5/11.4
R1209	7030009710	S.RES ERJ2GEJ 203 X (20K)	B	48.8/9.6
R1210	7030007350	S.RES ERJ2GEJ 393 X (39K)	B	47.9/9.6
R1211	7030005050	S.RES ERJ2GEJ 103 X (10K)	B	48.9/11.4
R1212	7030005050	S.RES ERJ2GEJ 103 X (10K)	B	48/11.4
R1213	7030005050	S.RES ERJ2GEJ 103 X (10K)	B	47.1/11.4
R1214	7030009710	S.RES ERJ2GEJ 203 X (20K)	B	46.2/11.4
R1215	7030007350	S.RES ERJ2GEJ 393 X (39K)	B	45.3/11.4
R1216	7030005050	S.RES ERJ2GEJ 103 X (10K)	B	44.7/12.6
R1217	7030005050	S.RES ERJ2GEJ 103 X (10K)	B	44.7/13.5
R1218	7030005050	S.RES ERJ2GEJ 103 X (10K)	B	44.7/14.4
R1219	7030005040	S.RES ERJ2GEJ 472 X (4.7K)	B	74.4/41.1
R1220	7030009710	S.RES ERJ2GEJ 203 X (20K)	B	44.7/15.3
R1221	7030005040	S.RES ERJ2GEJ 472 X (4.7K)	B	82.9/41.6
R1222	7030005040	S.RES ERJ2GEJ 472 X (4.7K)	B	74.4/40.2
R1223	7030005040	S.RES ERJ2GEJ 472 X (4.7K)	B	74.4/39.3
R1224	7030005040	S.RES ERJ2GEJ 472 X (4.7K)	B	82.9/39.3
R1225	7030005240	S.RES ERJ2GEJ 473 X (47K)	B	83.1/35.7
R1226	7030005240	S.RES ERJ2GEJ 473 X (47K)	B	74.4/37.5
R1227	7030005240	S.RES ERJ2GEJ 473 X (47K)	B	73.8/38.4
R1228	7030005240	S.RES ERJ2GEJ 473 X (47K)	B	82.2/35.7
R1229	7030007350	S.RES ERJ2GEJ 393 X (39K)	B	43.5/15.4
R1230	7030004970	S.RES ERJ2GEJ 470 X (47)	B	49.2/2.2
R1231	7030005050	S.RES ERJ2GEJ 103 X (10K)	B	48.8/5.4
R1232	7030005220	S.RES ERJ2GEJ 223 X (22K)	B	40.3/3.2
R1235	7030007270	S.RES ERJ2GEJ 151 X (150)	T	66.2/5.9
R1236	7030007270	S.RES ERJ2GEJ 151 X (150)	T	66.2/7
R1237	7030007290	S.RES ERJ2GEJ 22 X (2.2K)	B	61.1/7.6
R1251	7030011250	S.RES ERJ1TY 390U (39)	T	70.3/6.4
R1301	7030005220	S.RES ERJ2GEJ 223 X (22K)	T	78.1/37.8
R1302	7030005050	S.RES ERJ2GEJ 103 X (10K)	T	78.1/36
R1303	7030005240	S.RES ERJ2GEJ 473 X (47K)	B	66.2/1.2
R1304	7030005240	S.RES ERJ2GEJ 473 X (47K)	B	66/20.3
R1305	7030009160	S.RES ERJ2GEJ 181 X (180)	T	68.5/25.9
R1306	7030005060	S.RES ERJ2GEJ 333 X (33K)	T	78.7/11.4
R1307	7030005040	S.RES ERJ2GEJ 472 X (4.7K)	T	68/21.9
R1308	7030005110	S.RES ERJ2GEJ 224 X (220K)	T	67.5/20
R1309	7030005110	S.RES ERJ2GEJ 224 X (220K)	T	69/19.4
R1310	7030005110	S.RES ERJ2GEJ 224 X (220K)	T	67.5/18.8
R1311	7030005110	S.RES ERJ2GEJ 224 X (220K)	T	69/18.2
R1312	7030005110	S.RES ERJ2GEJ 224 X (220K)	T	67.5/17.6
R1313	7030005110	S.RES ERJ2GEJ 224 X (220K)	T	69/17
R1314	7030005110	S.RES ERJ2GEJ 224 X (220K)	T	67.5/16.4
R1315	7030005110	S.RES ERJ2GEJ 224 X (220K)	T	69/15.8
R1316	7030005110	S.RES ERJ2GEJ 224 X (220K)	B	66.6/12.3
R1317	7030005110	S.RES ERJ2GEJ 224 X (220K)	B	65.7/12.3
R1318	7030005110	S.RES ERJ2GEJ 224 X (220K)	B	64.8/12.3
R1319	7030005110	S.RES ERJ2GEJ 224 X (220K)	B	63.9/12.3
R1320	7030005110	S.RES ERJ2GEJ 224 X (220K)	B	63/12.3
R1321	7030005110	S.RES ERJ2GEJ 224 X (220K)	B	62.1/12.3
R1322	7030005110	S.RES ERJ2GEJ 224 X (220K)	B	61.2/12.3
R1323	7030005110	S.RES ERJ2GEJ 224 X (220K)	B	60.3/12.6
R1324	7030005050	S.RES ERJ2GEJ 103 X (10K)	T	80.5/12.1
R1325	7030007350	S.RES ERJ2GEJ 393 X (39K)	T	78.1/9.8
R1326	7030005010	S.RES ERJ2GEJ 681 X (680)	B	78.9/2
R1327	7030005240	S.RES ERJ2GEJ 473 X (47K)	B	66/19.4
R1328	7030005050	S.RES ERJ2GEJ 103 X (10K)	B	75.9/6.4
R1329	7030005240	S.RES ERJ2GEJ 473 X (47K)	B	75.9/5
R1331	7030010040	S.RES ERJ2GEJ-JPW	B	75.9

[LOGIC UNIT]

REF NO.	PARTS NO.	DESCRIPTION	M.	H/V LOCATION
R1409	7030005240	S.RES ERJ2GEJ 473 X (47K)	B	78.3/24.7
R1410	7030005240	S.RES ERJ2GEJ 473 X (47K)	B	78.3/23.5
R1411	7030005240	S.RES ERJ2GEJ 473 X (47K)	B	76.7/24.1
R1412	7030005240	S.RES ERJ2GEJ 473 X (47K)	B	43.6/24.7
R1413	7030005240	S.RES ERJ2GEJ 473 X (47K)	T	42.4/17.9
R1502	7030007300	S.RES ERJ2GEJ 332 X (3.3K)	B	80.9/28.4
R2102	7030005050	S.RES ERJ2GEJ 103 X (10K)	T	47.7/42.7
R2103	7030005050	S.RES ERJ2GEJ 103 X (10K)	T	47.6/40.5
R2104	7030005050	S.RES ERJ2GEJ 103 X (10K)	T	47.7/43.7
R2105	7030005050	S.RES ERJ2GEJ 103 X (10K)	T	47.5/41.7
R2110	7030010040	S.RES ERJ2GEJ-JPW	B	21.4/22.5
R2112	7030005040	S.RES ERJ2GEJ 472 X (4.7K)	T	38.5/44.4
R2201	7030004980	S.RES ERJ2GEJ 101 X (100)	T	31.5/11.1
R2202	7030005050	S.RES ERJ2GEJ 103 X (10K)	T	30.6/11.1
R2203	7030005050	S.RES ERJ2GEJ 103 X (10K)	T	21.5/22.4
R2204	7030005050	S.RES ERJ2GEJ 103 X (10K)	T	35.2/15.5
R2205	7030005050	S.RES ERJ2GEJ 103 X (10K)	T	35.2/16.4
R2206	7030005050	S.RES ERJ2GEJ 103 X (10K)	T	21.5/21.5
R2214	7030005050	S.RES ERJ2GEJ 103 X (10K)	T	27.5/11.1
R2215	7030005050	S.RES ERJ2GEJ 103 X (10K)	T	28.4/11.1
R2216	7030010040	S.RES ERJ2GEJ-JPW	T	34.8/37.3
C1	4030016930	S.CER ECJ0EB1A104K	T	16.9/25.1
C2	4030016930	S.CER ECJ0EB1A104K	B	38.1/36
C3	4030016930	S.CER ECJ0EB1A104K	B	39.5/28.9
C4	4030016930	S.CER ECJ0EB1A104K	B	42.4/35.8
C5	4550007310	S.TAN F930J227MNMBSMA	T	40.8/23.4
C51	4030016930	S.CER ECJ0EB1A104K	B	19.2/27.4
C52	4030016930	S.CER ECJ0EB1A104K	B	19.2/28.3
C53	4550007310	S.TAN F930J227MNMBSMA	T	11.4/30.3
C54	4550007310	S.TAN F930J227MNMBSMA	T	7.1/8
C201	4030016930	S.CER ECJ0EB1A104K	B	19.4/20.2
C203	4030018960	S.CER C3216 JB 1C 106MT-N	T	18.8/45.5
C204	4030016930	S.CER ECJ0EB1A104K	T	11.9/40.2
C205	4030016930	S.CER ECJ0EB1A104K	T	11.9/41.8
C206	4030016930	S.CER ECJ0EB1A104K	B	8.8/43.4
C207	4030019460	S.CER C1608 JB 0J 106M-T	T	9.9/45
C302	4030016930	S.CER ECJ0EB1A104K	T	30.2/40.4
C303	4030016930	S.CER ECJ0EB1A104K	T	30.4/37.8
C304	4030016930	S.CER ECJ0EB1A104K	T	26.9/37.2
C305	4030016930	S.CER ECJ0EB1A104K	T	34.1/45.8
C306	4030016930	S.CER ECJ0EB1A104K	T	29.2/37.2
C307	4030016930	S.CER ECJ0EB1A104K	B	38.3/35
C308	4030016930	S.CER ECJ0EB1A104K	T	27.3/39.3
C309	4030016930	S.CER ECJ0EB1A104K	T	30.6/39.1
C310	4030016930	S.CER ECJ0EB1A104K	T	24.5/45.8
C311	4030016930	S.CER ECJ0EB1A104K	T	22.4/2.3
C312	4030016930	S.CER ECJ0EB1A104K	T	27.8/40.5
C313	4030016930	S.CER ECJ0EB1A104K	T	22/39.6
C314	4030016930	S.CER ECJ0EB1A104K	T	29.1/45.8
C315	4030016930	S.CER ECJ0EB1A104K	T	27.3/38.4
C316	4030016930	S.CER ECJ0EB1A104K	T	30.4/36.9
C317	4030016930	S.CER ECJ0EB1A104K	T	26.9/40.5
C318	4030016930	S.CER ECJ0EB1A104K	T	31.1/40.4
C319	4030016930	S.CER ECJ0EB1A104K	T	29.3/40.4
C320	4030016930	S.CER ECJ0EB1A104K	T	27.8/37.2
C413	4030018960	S.CER C3216 JB 1C 106MT-N	B	21.3/19.6
C414	4030016930	S.CER ECJ0EB1A104K	B	16.3/16.8
C415	4030018960	S.CER C3216 JB 1C 106MT-N	B	15.6/26.3
C461	4030016930	S.CER ECJ0EB1A104K	B	34.2/4.3
C462	4030018960	S.CER C3216 JB 1C 106MT-N	B	35.3/5.8
C463	4030018960	S.CER C3216 JB 1C 106MT-N	T	42/8.7
C464	4030016930	S.CER ECJ0EB1A104K	T	43.6/10.4
C465	4030017740	S.CER ECJ0EB1E821K	B	27.4/5.5
C466	4030017760	S.CER ECJ0EB1H222K	B	29.5/4.3
C467	4030017740	S.CER ECJ0EB1E821K	B	30.7/5.5
C468	4030018560	S.CER C2012 JB 1A 475K-T	T	31.8/2.6
C469	4030016930	S.CER ECJ0EB1A104K	B	24.8/8.7
C470	4030016930	S.CER ECJ0EB1A104K	B	33.8/8.3
C471	4030018560	S.CER C2012 JB 1A 475K-T	T	36.2/4.2
C472	4030018560	S.CER C2012 JB 1A 475K-T	T	36.2/2.5
C473	4030016930	S.CER ECJ0EB1A104K	T	40.2/4.2
C509	4030018960	S.CER C3216 JB 1C 106MT-N	T	24.2/5.5
C510	4030016930	S.CER ECJ0EB1A104K	T	26/4.4
C511	4030017760	S.CER ECJ0EB1H222K	T	30.7/8.9
C512	4030017690	S.CER ECJ0EC1H121J	T	32.1/7.7
C513	4030017690	S.CER ECJ0EC1H121J	T	29.4/7.7
C514	4030016930	S.CER ECJ0EB1A104K	T	36.4/6.5
C515	4030018860	S.CER ECJ0EB0J105K	T	36.5/9.2
C516	4030018860	S.CER ECJ0EB0J105K	T	36.5/8.3
C517	4030018860	S.CER ECJ0EB0J105K	T	36.5/10.1
C518	4030016930	S.CER ECJ0EB1A104K	T	26.1/6.8
C519	4030016930	S.CER ECJ0EB1A104K	T	41.3/11.9
C522	4030017780	S.CER ECJ0EB1E472K	B	38.9/9.8
C523	4030017780	S.CER ECJ0EB1E472K	B	38/2.8
C524	4030017780	S.CER ECJ0EB1E472K	T	3.8/2.6
C525	4030017780	S.CER ECJ0EB1E472K	T	22.4/2.7
C526	4030017780	S.CER ECJ0EB1E472K	T	42.9/3.8
C527	4030017780	S.CER ECJ0EB1E472K	B	24.1/2.8
C551	4030018520	S.CER C1608 JB 0J 225M-T	T	20/13.8
C553	4030016930	S.CER ECJ0EB1A104K	T	19/13.9
C563	4030018960	S.CER C3216 JB 1C 106MT-N	B	18.9/6.6
C564	4030016930	S.CER ECJ0EB1A104K	T	18.1/13.9
C565	4030016930	S.CER ECJ0EB1A104K	T	17.8/3.2
C566	4030016930	S.CER ECJ0EB1A104K	T	19.4/3.2
C567	4030018960	S.CER C3216 JB 1C 106MT-N	B	21.3/12.3
C569	4030018960	S.CER C3216 JB 1C 106MT-N	B	19.2/12.3

[LOGIC UNIT]

REF NO.	PARTS NO.	DESCRIPTION	M.	H/V LOCATION
C601	4030018960	S.CER C3216 JB 1C 106MT-N	B	3.7/12
C602	4030016930	S.CER ECJ0EB1A104K	T	3.9/10.9
C603	4030018820	S.CER ECJ0EB1H561K	B	13.4/6
C604	4510008640	S.ELE 6 CE 100 FE	B	4.8/6.7
C605	4030016930	S.CER ECJ0EB1A104K	T	10/8.4
C606	4030018580	S.CER C1608 CH 1H 821J-T	B	9.6/5.6
C607	4030017440	S.CER ECJ0EC1H221J	B	13.3/8.4
C608	4030017440	S.CER ECJ0EC1H221J	B	14.8/8
C609	4030018860	S.CER ECJ0EB0J105K	B	15.8/14.5
C610	4030010760	S.CER C1608 CH 1H 331J-T	B	9.6/8.3
C611	4030010760	S.CER C1608 CH 1H 331J-T	B	11.8/7.7
C612	4030018960	S.CER C3216 JB 1C 106MT-N	B	7.5/13.1
C613	4550006780	S.TAN TEESVB2 0J 476M8R	B	20.6/2.7
C614	4550006780	S.TAN TEESVB2 0J 476M8R	T	3.1/6.6
C651	4030017460	S.CER ECJ0EB1E102K	B	65.5/31.4
C652	4030017460	S.CER ECJ0EB1E102K	B	66/16.4
C653	4030017460	S.CER ECJ0EB1E102K	B	77.1/20.9
C654	4030017430	S.CER ECJ0EC1H101J	B	77.2/28.2
C655	4030017430	S.CER ECJ0EC1H101J	B	76.5/27.1
C656	4030017430	S.CER ECJ0EC1H101J	B	76.1/26.2
C701	4030016930	S.CER ECJ0EB1A104K	B	3/13.5
C702	4030017780	S.CER ECJ0EB1E472K	B	4.4/18.8
C703	4030017780	S.CER ECJ0EB1E472K	B	7.5/26.1
C704	4030017780	S.CER ECJ0EB1E472K	B	19.7/26.2
C705	4030017430	S.CER ECJ0EC1H101J	B	4.6/21.9
C706	4030017430	S.CER ECJ0EC1H101J	B	4.6/24.6
C707	4030017430	S.CER ECJ0EC1H101J	B	3.9/27.2
C708	4030017430	S.CER ECJ0EC1H101J	B	6.6/26.1
C709	4030017430	S.CER ECJ0EC1H101J	T	2.5/20.1
C711	4550007310	S.TAN F930J227MNMBSMA	T	5.5/18.9
C715	4030017460	S.CER ECJ0EB1E102K	T	2.2/17.6
C716	4030017460	S.CER ECJ0EB1E102K	T	2.2/18.6
C717	4030017460	S.CER ECJ0EB1E102K	T	2.2/16.6
C1001	4030017780	S.CER ECJ0EB1E472K	B	76.7/18.9
C1002	4030017780	S.CER ECJ0EB1E472K	B	70.4/38.2
C1101	4030017780	S.CER ECJ0EB1E472K	T	79.9/23.7
C1102	4030017780	S.CER ECJ0EB1E472K	T	73.6/20.7
C1103	4030016930	S.CER ECJ0EB1A104K	T	81.8/14.5
C1106	4030017780	S.CER ECJ0EB1E472K	T	79.7/31.9
C1107	4030018900	S.CER ECJ0EB0J474K	B	80.1/25.5
C1108	4030018900	S.CER ECJ0EB0J474K	B	81.4/25.4
C1109	4030017780	S.CER ECJ0EB1E472K	T	79.7/26.3
C1110	4030017780	S.CER ECJ0EB1E472K	T	80.7/26.3
C1111	4030017780	S.CER ECJ0EB1E472K	T	81.7/26.3
C1112	4030017780	S.CER ECJ0EB1E472K	B	82.9/28.4
C1201	4030016930	S.CER ECJ0EB1A104K	B	50.6/4.3
C1202	4030017780	S.CER ECJ0EB1E472K	B	53.2/4.3
C1203	4030017650	S.CER ECJ0EC1H270J	B	62.7/6.7
C1204	4030016930	S.CER ECJ0EB1A104K	B	47.9/8
C1205	4030016930	S.CER ECJ0EB1A104K	B	45.2/9.6
C1206	4030016930	S.CER ECJ0EB1A104K	B	43.5/13.8
C1207	4030017430	S.CER ECJ0EC1H101J	B	47/9.6
C1208	4030017430	S.CER ECJ0EC1H101J	B	43.9/8.7
C1209	4030017430	S.CER ECJ0EC1H101J	B	44.4/11.4
C1210	4030017650	S.CER ECJ0EC1H270J	B	61.1/6.7
C1211	4030018860	S.CER ECJ0EB0J105K	B	60.2/10.5
C1212	4030016930	S.CER ECJ0EB1A104K	B	49.7/4.3
C1213	4030016930	S.CER ECJ0EB1A104K	B	49.2/6.6
C1214	4030016930	S.CER ECJ0EB1A104K	B	40.3/4.8
C1215	4030016930	S.CER ECJ0EB1A104K	B	64.2/19.3
C1216	4030016930	S.CER ECJ0EB1A104K	B	53.7/30.3
C1217	4030016930	S.CER ECJ0EB1A104K	B	57.5/29.2
C1218	4030016930	S.CER ECJ0EB1A104K	B	44.8/23.9
C1219	4030016930	S.CER ECJ0EB1A104K	B	46.3/13.2
C1220	4030016930	S.CER ECJ0EB1A104K	B	56/8.8
C1221	4030016930	S.CER ECJ0EB1A104K	B	60.5/13.7
C1222	4030016930	S.CER ECJ0EB1A104K	B	60.9/25.6
C1223	4030016930	S.CER ECJ0EB1A104K	T	52.7/12.3
C1225	4030018960	S.CER C3216 JB 1C 106MT-N	T	66.7/10.2
C1251	4030012610	S.CER C2012 JB 1C 474K-T	T	73.4/9.3
C1252	4550007320	S.TAN F930J226MAABMA	T	73.4/4.4
C1301	4030016930	S.CER ECJ0EB1A104K	T	80.1/40.3
C1302	4030018960	S.CER C3216 JB 1C 106MT-N	T	47.9/11.4
C1303	4030016790	S.CER ECJ0EB1C103K	T	67.9/30.4
C1304	4030016930	S.CER ECJ0EB1A104K	T	41.7/31.5
C1305	4030018960	S.CER C3216 JB 1C 106MT-N	T	44.3/37.2
C1306	4030016790	S.CER ECJ0EB1C103K	T	64/37.5
C1307	4030016930	S.CER ECJ0EB1A104K	T	48.4/12.9
C1308	4030016930	S.CER ECJ0EB1A104K	T	63.1/13.1
C1309	4030016930	S.CER ECJ0EB1A104K	T	46.1/37.2
C1310	4030016930	S.CER ECJ0EB1A104K	T	67/30.9
C1311	4030016930	S.CER ECJ0EB1A104K	T	67/25.7
C1312	4030017620	S.CER ECJ0EC1H100C	T	67.4/29.1
C1313	4030017620	S.CER ECJ0EC1H100C	T	67.4/28.2
C1314	4030016930	S.CER ECJ0EB1A104K	T	79/9.8
C1315	4030017030	S.CER ECJ0EB1A273K	T	83.3/10.8
C1316	4030016930	S.CER ECJ0EB1A104K	B	75.9/2.3
C1317	4030018960	S.CER C3216 JB 1C 106MT-N	B	84.4/3
C1319	4030018960	S.CER C3216 JB 1C 106MT-N	B	16.8/6.6
C2016	4030016930	S.CER ECJ0EB1A104K	B	37.7/29.3
C2017	4030016930	S.CER ECJ0EB1A104K	B	

[LOGIC UNIT]

REF NO.	PARTS NO.	DESCRIPTION	M.	H/V LOCATION
C2208	4030016930	S.CER ECJ0EB1A104K	T	21.5/23.4
C2209	4030016930	S.CER ECJ0EB1A104K	T	29.8/17.6
C2210	4030016930	S.CER ECJ0EB1A104K	T	26.6/17.8
C2211	4030016930	S.CER ECJ0EB1A104K	T	32.4/11.1
C2212	4030016930	S.CER ECJ0EB1A104K	T	35.2/14.6
C2213	4030016930	S.CER ECJ0EB1A104K	T	29.3/16.4
C2214	4030016930	S.CER ECJ0EB1A104K	T	35.2/17.3
C2215	4030016930	S.CER ECJ0EB1A104K	T	29.3/11.1
C2217	4030016930	S.CER ECJ0EB1A104K	T	29.8/18.5
C2218	4030016930	S.CER ECJ0EB1A104K	T	26.5/20.1
C2219	4030016930	S.CER ECJ0EB1A104K	T	30.2/16.4
C2220	4030016930	S.CER ECJ0EB1A104K	T	26.1/16.5
C2221	4030016930	S.CER ECJ0EB1A104K	T	27.9/16.5
C2222	4030016930	S.CER ECJ0EB1A104K	T	29.3/19.7
J651	6510024811	S.CON AXK6S60637YG	B	71/24.9
J701	6510022071	S.CON AXK6S30637YG	B	10.9/20.4
J1201	6510018891	S.CON 52559-1370(1390)	B	77.5/38.2
BT1301	3020000330	LIT ML-920S/DK		
EP2	6910012350	S.BEA MMZ1608Y 102BT	T	18.8/38.2
EP51	6910012350	S.BEA MMZ1608Y 102BT	B	18.1/29.7
EP201	6910014730	S.BEA MPZ2012S331A-T	T	13.3/40.6
EP301	6910012350	S.BEA MMZ1608Y 102BT	T	19.1/40
EP701	6910012350	S.BEA MMZ1608Y 102BT	B	5.6/15.3
EP2002	6910012350	S.BEA MMZ1608Y 102BT	B	38.2/27.6
EP2202	6910012350	S.BEA MMZ1608Y 102BT	T	19.1/22
EP2205	6910014730	S.BEA MPZ2012S331A-T	T	18.4/17.7
EP2217	6910015970	S.BEA MMZ1608B 301CT-AS	B	20.9/16.1

[CONNECT UNIT]

REF NO.	PARTS NO.	DESCRIPTION	M.	H/V LOCATION
J1	6510019971	S.CON 52808-1071	T	7.1/11.8
W1	8900016410	CAB OPC-1579A		

M.=Mounted side (T: Mounted on the Top side, B: Mounted on the Bottom side)
S.=Surface mount

[DDS UNIT]

REF NO.	PARTS NO.	DESCRIPTION	M.	H/V LOCATION
IC51	1190001811	S.IC AD9833BRMZ-REEL7 <FE>	T	38.7/3.5
IC52	1130012781	S.IC SN74AHC2G04HDC3	T	45/5.6
IC61	1130012610	S.IC SN74AHC1GU04DCKR	T	37.5/7.5
IC62	1130012850	S.IC SN74LVC3G34DCUR	T	51.3/24.7
IC251	1180002321	S.REG TK11218CMCL-G	B	29.5/16.2
IC301	1190002101	S.IC AD9951YSVZ <FE>	T	37.5/28.2
IC401	1110004080	S.IC UPC2709T-E3	T	50.1/47
IC451	1110006430	S.IC UPC1678GV-E1-A	T	34.1/50.2
IC801	1110006430	S.IC UPC1678GV-E1-A	T	18/13.7
IC901	1130012720	S.IC CD74HC4094PWR	T	5.4/64.7
Q1	1530002381	S.TRA 2SC4215-Y(TE85L,F)	T	20.4/3.1
Q101	1530002561	S.TRA 2SC4403-3-TL-E	T	26.5/6.4
Q151	1530003151	S.TRA 2SC4673D-TD-E	T	41.4/13.7
Q201	1530003432	S.TRA 2SC5226A-4-TL-E	T	43.4/19.4
Q211	1530003432	S.TRA 2SC5226A-4-TL-E	B	43.5/15.2
Q301	1590000680	S.TRA DTC114EUA T106	B	45.3/32.3
Q901	1590003930	S.TRA UMD22N TR	T	4/58.7
Q902	1590003930	S.TRA UMD22N TR	T	4.1/55.1
Q903	1590003930	S.TRA UMD22N TR	T	7.2/55.1
Q904	1590003930	S.TRA UMD22N TR	T	7.2/58.7
Q905	1590003930	S.TRA UMD22N TR	T	4.1/70.7
Q906	1590003930	S.TRA UMD22N TR	T	4.1/74.2
Q907	1590003930	S.TRA UMD22N TR	T	7.1/70.7
Q908	1590003930	S.TRA UMD22N TR	T	7.1/74.2
Q1101	1530002060	S.TRA 2SC4081 T106 R	T	40.9/53.9
Q1102	1540000451	S.TRA 2SD1623T-TD-E	T	45.5/54.3
D301	1750000620	S.DIO MA717WK(TX)	B	44.8/35.9
D341	1790001621	S.DIO 1SV308(TPL3,F)	B	45.2/39.7
D451	1750000581	S.DIO 1SV307(TPH3,F)	T	44.2/47.7
D452	1750000581	S.DIO 1SV307(TPH3,F)	T	44/44.8
D453	1790001621	S.DIO 1SV308(TPL3,F)	T	43.3/36.6
D454	1750000581	S.DIO 1SV307(TPH3,F)	T	38.3/48.3
D456	1750000620	S.DIO MA717WK(TX)	B	35.1/42.8
D458	1750000581	S.DIO 1SV307(TPH3,F)	T	33.8/45.6
D459	1750000581	S.DIO 1SV307(TPH3,F)	T	31.3/38.8
D471	1750000620	S.DIO MA717WK(TX)	T	33.2/36.6
D501	1750000581	S.DIO 1SV307(TPH3,F)	B	26.2/42.6
D502	1750000581	S.DIO 1SV307(TPH3,F)	T	3/50.6
D551	1750000581	S.DIO 1SV307(TPH3,F)	T	25.9/45.1
D552	1750000581	S.DIO 1SV307(TPH3,F)	T	2.9/45.3
D601	1750000581	S.DIO 1SV307(TPH3,F)	T	27.2/39.9
D602	1750000581	S.DIO 1SV307(TPH3,F)	T	2.9/40.1
D651	1750000581	S.DIO 1SV307(TPH3,F)	T	27.2/34.8
D652	1750000581	S.DIO 1SV307(TPH3,F)	T	2.9/34.9
D701	1750000581	S.DIO 1SV307(TPH3,F)	T	27.2/29.5
D702	1750000581	S.DIO 1SV307(TPH3,F)	T	2.9/29.7
D751	1750000581	S.DIO 1SV307(TPH3,F)	T	27/24.4
D752	1750000581	S.DIO 1SV307(TPH3,F)	T	2.9/24.6
D801	1750000581	S.DIO 1SV307(TPH3,F)	T	28.3/21.6
D802	1750000581	S.DIO 1SV307(TPH3,F)	T	2.9/19.3
D1101	1750000301	S.DIO 1SS302(TE85R,F)	T	40.9/57.7
D1102	1160000080	S.DIO DAP202K T146	B	27.9/63
FI101	2010002660	S.XTA DSF334SAF 124.032 MHz (FL-391)	T	29.3/10.7
FI201	2040001860	S.SAW NSVS776	T	34.5/16.5
X1	6050012800	S.XTA CR-788B VC-TCXO 24.8064 MHz	T	13.8/3.7
L1	6200002641	S.COI NLV25T-R15J	T	26/3.7
L51	6200005011	S.COI NLV25T-100J	B	35.6/4.2
L52	6200005011	S.COI NLV25T-100J	B	38.8/3.8
L53	6200003241	S.COI NLV32T-221J	B	43.4/8.7
L54	6200009351	S.COI ELJRE R22GFA	T	34.6/8.6
L101	6200003540	S.COI MLF1608D R22K-T	T	24.2/8.8
L105	6200012650	S.COI MLF1608A 1R5J-T	T	23.7/5.2
L151	6200004470	S.COI MLF1608D R12K-T	T	44.7/12.8
L153	6200004150	S.COI MLF1608D 47NM-T	T	46.9/15.7
L201	6200004150	S.COI MLF1608D 47NM-T	T	44.5/21.5
L202	6200005661	S.COI ELJRE 10NGFA	B	37.5/12.4
L204	6200003540	S.COI MLF1608D R22K-T	T	41.5/19.3
L205	6200005711	S.COI ELJRE 27NGFA	B	47.1/21.7
L206	6200005701	S.COI ELJRE 22NGFA	B	46.2/20.4
L210	6200005701	S.COI ELJRE 22NGFA	B	47/19.1
L212	6200002581	S.COI NLV25T-033J	B	41.9/12.8
L213	6200005681	S.COI ELJRE 15NGFA	B	40.1/17.8
L301	6140002810	S.COI LR-317	T	48.5/30
L302	6140002810	S.COI LR-317	T	48.7/38.9
L303	6200004150	S.COI MLF1608D 47NM-T	B	41.9/35.7
L304	6200003960	S.COI MLF1608A 1R0K-T	T	50.4/33.2
	6200003960	S.COI MLF1608A 1R0K-T	[EUR]	
	6200003960	S.COI MLF1608A 1R0K-T	[FRA]	
	6200003960	S.COI MLF1608A 1R0K-T	[ESP]	
	6200003960	S.COI MLF1608A 1R0K-T	[USA]	
	6200003960	S.COI MLF1608A 1R0K-T	[EXP]	
	6200003960	S.COI MLF1608A 1R0K-T	[ITR]	
	6200003960	S.COI MLF1608A 1R0K-T	[UK]	
	6200003960	S.COI MLF1608A 1R0K-T	[KOR]	
	6200003960	S.COI MLF1608A 1R0K-T	[CHN]	
L321	6200009560	S.COI MLG1608B R10J-T	T	50.4/34.7
L322	6200011770	S.COI LQW18ANR10G00D	T	47.8/34.7
L323	6200005671	S.COI ELJRE 12NGFA	T	53.6/30.1

[DDS UNIT]

REF NO.	PARTS NO.	DESCRIPTION	M.	H/V LOCATION
L331	6200009680	S.COI MLG1608B 47NJ-T	T	47.6/43.1
L332	6200009680	S.COI MLG1608B 47NJ-T	T	50.2/43.1
L341	6200004470	S.COI MLF1608D R12K-T	B	41.1/37
L401	6200001981	S.COI NLV25T-R10J	T	50.2/49.9
L411	6200009610	S.COI MLG1608B 39NJ-T	T	47.3/48.3
L456	6140002810	S.COI LR-317	T	40.1/44.9
L458	6200009680	S.COI MLG1608B 47NJ-T	B	37.5/42.1
L461	6200009660	S.COI MLG1608B 10NJ-T	B	39.3/41.7
L464	6200002631	S.COI NLV25T-R10J	T	28.8/50.6
L465	6200004470	S.COI MLF1608D R12K-T	T	42.9/39.5
L466	6200011580	S.COI LQW18AN33NG00D	T	39.1/41.1
L467	6200009670	S.COI MLG1608B 12NJ-T	T	27.7/47.1
L468	6200009590	S.COI MLG1608B 18NJ-T	T	26.1/48.3
L469	6200009580	S.COI MLG1608B 15NJ-T	T	33.6/41.3
L471	6140002810	S.COI LR-317	T	38.7/37.2
L472	6200009680	S.COI MLG1608B 47NJ-T	T	33.4/39.3
L473	6200009540	S.COI MLG1608B 22NJ-T	T	35.5/40.4
L501	6200002611	S.COI NLV25T-R47J	B	21.7/43.6
L502	6200002631	S.COI NLV25T-R10J	B	18.1/46.7
L503	6200002431	S.COI NLV25T-082J	B	15/46.4
L504	6200002411	S.COI NLV25T-056J	T	14.3/49.4
L505	6200002421	S.COI NLV25T-068J	T	11.2/50.2
L506	6200002421	S.COI NLV25T-068J	T	8.2/49.7
L507	6200002611	S.COI NLV25T-R47J	T	3.8/48.2
L551	6200002611	S.COI NLV25T-R47J	T	24.9/42.6
L552	6200002421	S.COI NLV25T-068J	T	20.3/43
L553	6200002411	S.COI NLV25T-056J	T	17.6/42.9
L554	6200002601	S.COI NLV25T-047J	T	14.7/45
L555	6200002601	S.COI NLV25T-047J	T	12/44.3
L556	6200002581	S.COI NLV25T-033J	T	9.2/45
L557	6200002611	S.COI NLV25T-R47J	T	4.5/42.8
L601	6200002611	S.COI NLV25T-R47J	T	25.3/37.4
L602	6200002601	S.COI NLV25T-047J	T	22.6/39.6
L603	6200002591	S.COI NLV25T-039J	T	19.7/39.1
L604	6200003891	S.COI NLV25T-027J	T	16.8/39.9
L605	6200002601	S.COI NLV25T-047J	T	14.1/37.9
L606	6200002601	S.COI NLV25T-047J	T	11.4/37.7
L607	6200002421	S.COI NLV25T-068J	T	8.6/37.7
L608	6200002601	S.COI NLV25T-047J	T	5.1/37.7
L651	6200002611	S.COI NLV25T-R47J	T	26/32.2
L652	6200002591	S.COI NLV25T-039J	T	22.4/32.5
L653	6200002591	S.COI NLV25T-039J	T	19.6/32.8
L654	6200002591	S.COI NLV25T-039J	T	14/34.6
L655	6200002591	S.COI NLV25T-039J	T	11.2/33.9
L656	6200002601	S.COI NLV25T-047J	T	16.7/32.5
L657	6200002581	S.COI NLV25T-033J	T	7.9/34.6
L658	6200002611	S.COI NLV25T-R47J	T	5.2/32.6
L701	6200002611	S.COI NLV25T-R47J	T	26/26.9
L702	6200002581	S.COI NLV25T-033J	T	22.9/29.2
L703	6200002581	S.COI NLV25T-033J	T	20.2/28.7
L704	6200003891	S.COI NLV25T-027J	T	17.3/29.5
L705	6200002591	S.COI NLV25T-039J	T	14.6/27.3
L706	6200002581	S.COI NLV25T-033J	T	11.8/27.3
L707	6200002581	S.COI NLV25T-033J	T	9.1/27.2
L708	6200002611	S.COI NLV25T-R47J	T	4.5/27.2
L751	6200002611	S.COI NLV25T-R47J	T	25.9/22
L752	6200003881	S.COI NLV25T-022J	T	22.4/22.4
L753	6200003891	S.COI NLV25T-027J	T	19.7/22.2
L754	6200002581	S.COI NLV25T-033J	T	16.9/22.5
L755	6200003891	S.COI NLV25T-027J	T	14.2/24.2
L756	6200003891	S.COI NLV25T-027J	T	11.4/23.5
L757	6200003881	S.COI NLV25T-022J	T	8.7/24.2
L758	6200002611	S.COI NLV25T-R47J	T	3.9/22.2
L801	6200002181	S.COI NLV25T-R12J	T	28.3/17.5
L803	6200005711	S.COI ELJRE 27NGFA	T	26.3/17.6
L804	6200009070	S.COI LQW18AN18NG00D (LQW1608A18NG00)	T	25/15.6
L805	6200009220	S.COI LQW18AN15NG00D (LQW1608A15NG00)	T	23.1/14.9
L806	6200005641	S.COI ELJRE 6N8ZFA	T	21.5/19
L807	6200009670	S.COI MLG1608B 12NJ-T	T	18.7/18.2
L808	6200004720	S.COI MLF1608D R10K-T	T	17.9/10
L812	6200005711	S.COI ELJRE 27NGFA	T	14.8/14.4
L813	6200009070	S.COI LQW18AN18NG00D (LQW1608A18NG00)	T	15.7/17.2
L814	6200009220	S.COI LQW18AN15NG00D (LQW1608A15NG00)	T	13.8/18.2
L815	6200005641	S.COI ELJRE 6N8ZFA	T	10.1/18
L816	6200010700	S.COI LQW18AN12NG00D	T	6.6/17.8
L818	6200002181	S.COI NLV25T-R12J	T	4.6/17
L851	6200002181	S.COI NLV25T-R12J	B	26.8/30.6
L852	6200002611	S.COI NLV25T-R47J	B	26.4/34.1
L853	6200002181	S.COI NLV25T-R12J	B	3.4/22.8
L854	6200002611	S.COI NLV25T-R47J	B	5.4/26
L901	6200007420	S.COI ELJFC 101K-F	B	3.7/65.9
L953	6200002041	S.COI NLV25T-101J	B	56.4/44.6
L954	6200002041	S.COI NLV25T-101J	B	55.7/42.1
L955	6200002041	S.COI NLV25T-101J	B	55.9/39.6
L956	6200002041	S.COI NLV25T-101J	B	56.1/37.1
L957	6200002041	S.COI NLV25T-101J	B	55.9/34.6
L959	6200011300	S.COI EXCML16A270U	T	54.9/34.3
L960	6200002041	S.COI NLV25T-101J	B	56.6/30.3
L962	6200011300	S.COI EXCML16A270U	B	59.2/32.2
L963	6200011300	S.COI EXCML16A270U	B	60.4/32.2
L1001	6200003241	S.COI NLV32T-221J	B	53.7/50.8
L1002	6200003241	S.COI NLV32T-221J	B	47.9/55
L1103	6200002041	S.COI NLV25T-101J	B	42.2/61.2
L1105	6200002041	S.COI NLV25T-101J	B	40.8/71.8

M.=Mounted side (T: Mounted on the Top side, B: Mounted on the Bottom side)
S.=Surface mount

[DDS UNIT]

REF NO.	PARTS NO.	DESCRIPTION	M.	H/V LOCATION
L1106	6200002041	S.COI NLV25T-101J	T	36.4/62.3
L1107	6200002041	S.COI NLV25T-101J	B	34.9/74.7
L1110	6200002041	S.COI NLV25T-101J	T	32.4/62.3
L1111	6200002041	S.COI NLV25T-101J	B	26.1/69.8
L1112	6200002041	S.COI NLV25T-101J	T	29.9/62.3
L1152	6200003590	S.COI EXCCL3225U1	T	48.3/69.2
L1153	6200002041	S.COI NLV25T-101J	T	45.5/69.3
L1154	6200002041	S.COI NLV25T-101J	T	53.6/69.2
R2	7030007290	S.RES ERJ2GEJ 222 X (2.2K)	T	19.1/4.5
R3	7030005040	S.RES ERJ2GEJ 472 X (4.7K)	T	18.6/1.8
R4	7030004990	S.RES ERJ2GEJ 221 X (220)	T	22.2/2.6
R5	7030004980	S.RES ERJ2GEJ 101 X (100)	T	20.9/6.9
R8	7030003630	S.RES ERJ3GEYJ 393 V (39K)	B	13.6/7.1
R9	7030003610	S.RES ERJ3GEYJ 273 V (27K)	B	13.6/9.7
R10	7030005060	S.RES ERJ2GEJ 333 X (33K)	T	8/3.2
R11	7030010040	S.RES ERJ2GEJ-JPW	T	9.2/3.7
R51	7030005120	S.RES ERJ2GEJ 102 X (1K)	T	35.7/9.5
R52	7030005120	S.RES ERJ2GEJ 102 X (1K)	T	46.1/2.3
R53	7030005120	S.RES ERJ2GEJ 102 X (1K)	T	42.8/3.5
R54	7030005120	S.RES ERJ2GEJ 102 X (1K)	T	42.8/2.6
R61	7030005050	S.RES ERJ2GEJ 103 X (10K)	T	39.3/8.1
R62	7030005530	S.RES ERJ2GEJ 100 X (10)	T	49.3/23.1
R101	7030005000	S.RES ERJ2GEJ 471 X (470)	T	25.2/7.8
R102	7030004980	S.RES ERJ2GEJ 101 X (100)	T	22.1/7.4
R103	7030005570	S.RES ERJ2GEJ 820 X (82)	T	31.8/11.1
R104	7030004980	S.RES ERJ2GEJ 101 X (100)	T	33/11.5
R105	7030005570	S.RES ERJ2GEJ 820 X (82)	T	34.2/11.2
R106	7030005100	S.RES ERJ2GEJ 154 X (150K)	T	23.9/7.4
R121	7030005040	S.RES ERJ2GEJ 472 X (4.7K)	T	38.5/11.1
R150	7030005570	S.RES ERJ2GEJ 820 X (82)	T	45.8/10.7
R151	7030004980	S.RES ERJ2GEJ 101 X (100)	T	44.9/10.7
R154	7030005050	S.RES ERJ2GEJ 103 X (10K)	T	41.4/10.6
R155	7030005530	S.RES ERJ2GEJ 100 X (10)	T	46.3/12.6
R157	7030007270	S.RES ERJ2GEJ 151 X (150)	T	48.8/18.2
R158	7030009200	S.RES ERJ2GEJ 390 X (39)	T	48/16.7
R159	7030007270	S.RES ERJ2GEJ 151 X (150)	T	47.9/18.2
R160	7030005300	S.RES ERJ2GEJ 150 X (15)	T	44.2/15.9
R161	7030004980	S.RES ERJ2GEJ 101 X (100)	T	45.1/15.9
R162	7030005300	S.RES ERJ2GEJ 150 X (15)	T	45/14.6
R201	7030005530	S.RES ERJ2GEJ 100 X (10)	T	45.8/22.2
R202	7030000700	S.RES MCR10EZHJ 470 K (474)	T	45.6/18.8
R211	7030003400	S.RES ERJ3GEYJ 471 V (470)	B	37.3/17.8
R212	7030003440	S.RES ERJ3GEYJ 102 V (1K)	B	40.8/16.2
R213	7030003200	S.RES ERJ3GEYJ 100 V (10)	B	44.5/11.4
R214	7030003280	S.RES ERJ3GEYJ 470 V (47)	B	46.8/16.3
R301	7030005120	S.RES ERJ2GEJ 102 X (1K)	T	34.2/22.2
R303	7030010040	S.RES ERJ2GEJ-JPW	T	40/22.2
R304	7030005120	S.RES ERJ2GEJ 102 X (1K)	T	42/24.6
R305	7030005710	S.RES ERJ2GEJ 121 X (120)	T	44.1/28.9
R306	7030005120	S.RES ERJ2GEJ 102 X (1K)	T	31.5/25.6
R309	7030005120	S.RES ERJ2GEJ 102 X (1K)	T	31.2/29.4
R310	7030005120	S.RES ERJ2GEJ 102 X (1K)	T	31.2/30.5
R311	7030005120	S.RES ERJ2GEJ 102 X (1K)	T	31.2/31.5
R312	7030010040	S.RES ERJ2GEJ-JPW	T	32.9/31.7
R313	7030005710	S.RES ERJ2GEJ 121 X (120)	T	43.2/28.5
R314	7030009140	S.RES ERJ2GEJ 272 X (2.7K)	T	43/31.8
R315	7030005120	S.RES ERJ2GEJ 102 X (1K)	T	33.5/32.6
R316	7030005050	S.RES ERJ2GEJ 103 X (10K)	T	34.6/33.8
R317	7030004990	S.RES ERJ2GEJ 221 X (220)	T	43.9/31.8
R318	7030003860	S.RES ERJ3GE JPW V	[EUR] B	35.8/28.4
	7030003860	S.RES ERJ3GE JPW V	[FRA]	
	7030003860	S.RES ERJ3GE JPW V	[ESP]	
	7030003860	S.RES ERJ3GE JPW V	[USA]	
	7030003860	S.RES ERJ3GE JPW V	[EXP]	
	7030003860	S.RES ERJ3GE JPW V	[ITR]	
	7030003860	S.RES ERJ3GE JPW V	[KOR]	
	7030003860	S.RES ERJ3GE JPW V	[AUS]	
	7030003860	S.RES ERJ3GE JPW V	[CHN]	
R341	7030003440	S.RES ERJ3GEYJ 102 V (1K)	B	44.3/38.3
R342	7030003440	S.RES ERJ3GEYJ 102 V (1K)	B	45.9/41.2
R451	7030005120	S.RES ERJ2GEJ 102 X (1K)	T	44.5/46.2
R452	7030003860	S.RES ERJ3GE JPW V	B	48.6/44.6
R453	7030010090	S.RES ERJ2GEJ 180 X (18)	T	34.1/47.4
R454	7030008280	S.RES ERJ2GEJ 271 X (270)	T	32.9/47
R455	7030008280	S.RES ERJ2GEJ 271 X (270)	T	32.9/47.9
R456	7030010040	S.RES ERJ2GEJ-JPW	T	34.9/52.4
R457	7030005120	S.RES ERJ2GEJ 102 X (1K)	T	38.1/49.7
R458	7030004990	S.RES ERJ2GEJ 221 X (220)	T	31.6/43.6
R459	7030005090	S.RES ERJ2GEJ 104 X (100K)	T	42.1/50
R460	7030003680	S.RES ERJ3GEYJ 104 V (100K)	T	30.7/41
R461	7030005090	S.RES ERJ2GEJ 104 X (100K)	T	29.6/39.1
R462	7030003860	S.RES ERJ3GE JPW V	T	45/43.3
R463	7030003400	S.RES ERJ3GEYJ 471 V (470)	T	33/44.4
R464	7030004980	S.RES ERJ2GEJ 101 X (100)	T	40.8/47.9
R465	7030005570	S.RES ERJ2GEJ 820 X (82)	T	40.3/50
R467	7030005570	S.RES ERJ2GEJ 820 X (82)	T	40.8/48.8
R468	7030005570	S.RES ERJ2GEJ 820 X (82)	T	41.2/50
R469	7030003320	S.RES ERJ3GEYJ 101 V (100)	B	37.7/39.9
R471	7030005000	S.RES ERJ2GEJ 471 X (470)	T	41.6/37.7
R472	7030004990	S.RES ERJ2GEJ 221 X (220)	T	30.3/43.3
R473	7030007270	S.RES ERJ2GEJ 151 X (150)	T	31.7/34.5
R474	7030009200	S.RES ERJ2GEJ 390 X (39)	T	31.3/35.7
R475	7030007270	S.RES ERJ2GEJ 151 X (150)	T	30.1/35.3
R476	7030005000	S.RES ERJ2GEJ 471 X (470)	T	29.9/37.9
R477	7030003320	S.RES ERJ3GEYJ 101 V (100)	B	35.7/38.6
R501	7030003390	S.RES ERJ3GEYJ 391 V (390)	B	21/46.1

[DDS UNIT]

REF NO.	PARTS NO.	DESCRIPTION	M.	H/V LOCATION
R502	7030009280	S.RES ERJ2GEJ 391 X	T	5.8/46.8
R503	7030005090	S.RES ERJ2GEJ 104 X (100K)	T	14.3/46.8
R505	7030005570	S.RES ERJ2GEJ 820 X (82)	T	6.5/48.6
R506	7030005570	S.RES ERJ2GEJ 820 X (82)	T	6/49.8
R507	7030005570	S.RES ERJ2GEJ 820 X (82)	T	5.6/48.6
R551	7030009280	S.RES ERJ2GEJ 391 X	T	23.1/42
R552	7030009280	S.RES ERJ2GEJ 391 X	T	6.3/42
R553	7030005090	S.RES ERJ2GEJ 104 X (100K)	T	10.1/41.6
R554	7030009200	S.RES ERJ2GEJ 390 X (39)	T	6.4/45.7
R555	7030007270	S.RES ERJ2GEJ 151 X (150)	T	7.1/44.4
R556	7030007270	S.RES ERJ2GEJ 151 X (150)	T	6.2/44.3
R601	7030008280	S.RES ERJ2GEJ 271 X (270)	T	23.2/36.1
R602	7030009280	S.RES ERJ2GEJ 391 X	T	6.8/36.6
R603	7030005090	S.RES ERJ2GEJ 104 X (100K)	T	19.6/36.4
R604	7030004980	S.RES ERJ2GEJ 101 X (100)	T	20.8/36.1
R651	7030009280	S.RES ERJ2GEJ 391 X	T	24.2/31.2
R652	7030009280	S.RES ERJ2GEJ 391 X	T	6.3/30.5
R653	7030005090	S.RES ERJ2GEJ 104 X (100K)	T	9.9/31.2
R701	7030009280	S.RES ERJ2GEJ 391 X	T	23.8/25.8
R702	7030009280	S.RES ERJ2GEJ 391 X	T	6.5/26
R703	7030005090	S.RES ERJ2GEJ 104 X (100K)	T	19.9/26
R704	7030004980	S.RES ERJ2GEJ 101 X (100)	T	7.2/27.2
R705	7030005710	S.RES ERJ2GEJ 121 X (120)	T	6.7/28.4
R706	7030004980	S.RES ERJ2GEJ 101 X (100)	T	6.3/27.2
R751	7030009280	S.RES ERJ2GEJ 391 X	T	24.2/21
R752	7030009280	S.RES ERJ2GEJ 391 X	T	5.9/20.8
R753	7030005090	S.RES ERJ2GEJ 104 X (100K)	T	10.3/20.8
R755	7030004980	S.RES ERJ2GEJ 101 X (100)	T	6.6/22.6
R756	7030005580	S.RES ERJ2GEJ 560 X (56)	T	6.6/24.2
R757	7030004980	S.RES ERJ2GEJ 101 X (100)	T	5.7/23.3
R801	7030008280	S.RES ERJ2GEJ 271 X (270)	T	27.2/14.5
R805	7030005570	S.RES ERJ2GEJ 820 X (82)	T	13.9/10.3
R806	7030005570	S.RES ERJ2GEJ 820 X (82)	T	14.2/11.7
R807	7030005570	S.RES ERJ2GEJ 820 X (82)	T	13/11.3
R808	7030003390	S.RES ERJ3GEYJ 391 V (390)	B	3.6/17.9
R810	7030005090	S.RES ERJ2GEJ 104 X (100K)	T	27.2/15.4
R841	7030005710	S.RES ERJ2GEJ 121 X (120)	T	21.2/12.5
R851	7030009280	S.RES ERJ2GEJ 391 X	T	27.1/37.3
R852	7030008280	S.RES ERJ2GEJ 271 X (270)	T	5.7/13.7
R853	7030010090	S.RES ERJ2GEJ 180 X (18)	T	6.9/14
R854	7030008280	S.RES ERJ2GEJ 271 X (270)	T	6.9/13
R855	7030003390	S.RES ERJ3GEYJ 391 V (390)	B	5.5/29.5
R901	7030005120	S.RES ERJ2GEJ 102 X (1K)	T	2.1/62.6
R902	7030005120	S.RES ERJ2GEJ 102 X (1K)	T	2.2/60.9
R903	7030005120	S.RES ERJ2GEJ 102 X (1K)	T	2.2/58.7
R951	7030003360	S.RES ERJ3GEYJ 221 V (220)	B	59.2/6.9
R952	7030004990	S.RES ERJ2GEJ 221 X (220)	T	54/9.3
R953	7030003360	S.RES ERJ3GEYJ 221 V (220)	B	59.5/3.3
R954	7030004990	S.RES ERJ2GEJ 221 X (220)	T	53.1/8.9
R955	7030004990	S.RES ERJ2GEJ 221 X (220)	T	55.2/7.7
R956	7030003360	S.RES ERJ3GEYJ 221 V (220)	B	59.2/4.9
R957	7030003360	S.RES ERJ3GEYJ 221 V (220)	B	56.6/5
R958	7030004990	S.RES ERJ2GEJ 221 X (220)	T	47.2/6.1
R959	7030003360	S.RES ERJ3GEYJ 221 V (220)	B	57.9/51
R960	7030003280	S.RES ERJ3GEYJ 470 V (47)	B	57.5/49
R961	7030004990	S.RES ERJ2GEJ 221 X (220)	T	54.6/11.6
R962	7030003860	S.RES ERJ3GE JPW V	T	51.3/21
R1051	7030003860	S.RES ERJ3GE JPW V	B	10.8/73
R1101	7030005120	S.RES ERJ2GEJ 102 X (1K)	T	40.5/52.1
R1102	7030005050	S.RES ERJ2GEJ 103 X (10K)	T	42.1/52.1
R1103	7030004980	S.RES ERJ2GEJ 101 X (100)	T	39.3/63.4
R1104	7030005050	S.RES ERJ2GEJ 103 X (10K)	T	44.2/51.2
R1105	7030004980	S.RES ERJ2GEJ 101 X (100)	T	38.7/60.9
R1106	7030007290	S.RES ERJ2GEJ 222 X (2.2K)	T	31.8/59.6
R1107	7030007290	S.RES ERJ2GEJ 222 X (2.2K)	T	28.1/59.6
R1108	7030005240	S.RES ERJ2GEJ 473 X (47K)	T	46.9/8.5
R1109	7030005240	S.RES ERJ2GEJ 473 X (47K)	T	47.9/8.5
C1	4030016950	S.CER ECJ0EB1A473K	T	17.5/4.5
C2	4030017780	S.CER ECJ0EB1E472K	T	20.9/5
C3	4030017510	S.CER ECJ0EC1H680J	T	24.8/1.7
C4	4030017780	S.CER ECJ0EB1E472K	T	22.3/4.6
C5	4030017680	S.CER ECJ0EC1H820J	T	26/2
C6	4030017510	S.CER ECJ0EC1H680J	T	27.2/1.7
C7	4030016930	S.CER ECJ0EB1A104K	T	8/4.1
C8	4030016790	S.CER ECJ0EB1C103K	T	10.1/5.7
C51	4030017780	S.CER ECJ0EB1E472K	T	33.8/6.5
C52	4030017780	S.CER ECJ0EB1E472K	T	36.1/5.3
C53	4030017780	S.CER ECJ0EB1E472K	T	36.9/9.4
C54	4030016930	S.CER ECJ0EB1A104K	T	34.9/4.4
C55	4510008580	S.ELE EEE0JA470SR	T	30.6/3.9
C56	4030016930	S.CER ECJ0EB1A104K	T	34.9/2.8
C57	4030016930	S.CER ECJ0EB1A104K	T	42.8/5
C58	4030016930	S.CER ECJ0EB1A104K	T	41.5/9
C59	4030017720	S.CER ECJ0EB1H331K	T	41.9/6.6
C60	4030017690	S.CER ECJ0EC1H121J	T	42.2/7.8
C61	4030017720	S.CER ECJ0EB1H331K	T	42.8/6.6
C62	4030016930	S.CER ECJ0EB1A104K	T	35.6/6.5
C63	4030016930	S.CER ECJ0EB1A104K	T	49.3/22.2
C64	4030017710	S.CER ECJ0EC1H181J	T	34.7/6.5
C65	4030017710	S.CER ECJ0EC1H181J	T	33.4/8.9
C101	4030017580	S.CER ECJ0EC1H060C	T	26.4/8.7
C102	4030017660	S.CER ECJ0EC1H330J	T	23.1/2.6
C104	4030017780	S.CER ECJ		

[DDS UNIT]

REF NO.	PARTS NO.	DESCRIPTION	M.	H/V LOCATION
C150	4030017780	S.CER ECJ0EB1E472K	T	44/10.7
C151	4030017780	S.CER ECJ0EB1E472K	T	46.3/13.6
C152	4030017640	S.CER ECJ0EC1H150J	T	43.3/16
C154	4030017660	S.CER ECJ0EC1H330J	T	46.6/14.6
C155	4030017600	S.CER ECJ0EC1H080C	T	46.4/16.7
C156	4030017660	S.CER ECJ0EC1H330J	T	47/18.2
C157	4030007090	S.CER C1608 CH 1H 470J-T	B	53/15.3
C202	4030017590	S.CER ECJ0EC1H070C	T	43.8/17.2
C203	4030007060	S.CER C1608 CH 1H 270J-T	B	37.8/15.9
C204	4030016930	S.CER ECJ0EB1A104K	T	35.1/20.1
C206	4030017560	S.CER ECJ0EC1H2R5B	T	43.4/21.7
C207	4030007110	S.CER C1608 CH 1H 680J-T	B	44/21.7
C208	4030009910	S.CER C1608 CH 1H 040B-T	B	40.9/21.7
C209	4030007060	S.CER C1608 CH 1H 270J-T	B	43.1/20.4
C210	4030009910	S.CER C1608 CH 1H 040B-T	B	40.8/19.8
C211	4030017460	S.CER ECJ0EB1E102K	T	42.2/17.6
C216	4030017780	S.CER ECJ0EB1E472K	T	46.3/20.8
C217	4030007120	S.CER C1608 CH 1H 820J-T	B	43.9/19.1
C218	4030011770	S.CER C1608 CH 1H 060B-T	B	43.2/17.8
C219	4030007010	S.CER C1608 CH 1H 100D-T	B	46.2/17.8
C221	4030006880	S.CER C1608 JB 1H 472K-T	B	46/15
C222	4030009910	S.CER C1608 CH 1H 040B-T	B	40.7/14.7
C223	4030006880	S.CER C1608 JB 1H 472K-T	B	46/13.4
C224	4030018630	S.CER C2012 CH 1H 472J-T	B	39.2/11.4
C225	4030006860	S.CER C1608 JB 1H 102K-T	B	38.4/19.4
C251	4030011600	S.CER C1608 JB 1E 104K-T	B	27.6/12.2
C252	4030011600	S.CER C1608 JB 1E 104K-T	B	28.7/23.5
C253	4550007090	S.TAN TEESVA 1A 226M8R	B	29.6/21.7
C254	4030011600	S.CER C1608 JB 1E 104K-T	B	29.2/12.2
C255	4550007090	S.TAN TEESVA 1A 226M8R	B	29.5/19.3
C302	4030016930	S.CER ECJ0EB1A104K	T	36.2/22.2
C303	4030016930	S.CER ECJ0EB1A104K	T	37.3/22.2
C304	4030016930	S.CER ECJ0EB1A104K	T	38.2/22.2
C305	4030016930	S.CER ECJ0EB1A104K	T	39.1/22.2
C306	4030016930	S.CER ECJ0EB1A104K	T	43.6/24.6
C307	4030016930	S.CER ECJ0EB1A104K	T	31.2/28.3
C308	4030016930	S.CER ECJ0EB1A104K	T	43.6/25.5
C309	4030016930	S.CER ECJ0EB1A104K	T	43/26.7
C310	4030016930	S.CER ECJ0EB1A104K	T	43.9/26.7
C312	4030016930	S.CER ECJ0EB1A104K	T	43.4/30.6
C317	4030011600	S.CER C1608 JB 1E 104K-T	B	44/26.1
C318	4030006880	S.CER C1608 JB 1H 472K-T	B	39.2/25.4
C321	4030017500	S.CER ECJ0EC1H560J	T	51.2/30.2
C323	4030017510	S.CER ECJ0EC1H680J	T	48.6/33.3
C325	4030017660	S.CER ECJ0EC1H330J	T	48/35.7
C326	4030017640	S.CER ECJ0EC1H150J	T	53.1/32
C328	4030006880	S.CER C1608 JB 1H 472K-T	[EUR] B	39.7/29.6
	4030006880	S.CER C1608 JB 1H 472K-T	[FRA]	
	4030006880	S.CER C1608 JB 1H 472K-T	[ESP]	
	4030006880	S.CER C1608 JB 1H 472K-T	[USA]	
	4030006880	S.CER C1608 JB 1H 472K-T	[EXP]	
	4030006880	S.CER C1608 JB 1H 472K-T	[ITR]	
	4030006880	S.CER C1608 JB 1H 472K-T	[KOR]	
	4030006880	S.CER C1608 JB 1H 472K-T	[AUS]	
	4030006880	S.CER C1608 JB 1H 472K-T	[CHN]	
C331	4030017390	S.CER ECJ0EC1H180J	T	46.6/44.5
C333	4030017670	S.CER ECJ0EC1H390J	T	48.4/44.5
C335	4030017390	S.CER ECJ0EC1H180J	T	50.2/44.5
C341	4030007130	S.CER C1608 CH 1H 101J-T	[EUR] B	42.5/39.7
	4030007130	S.CER C1608 CH 1H 101J-T	[FRA]	
	4030007130	S.CER C1608 CH 1H 101J-T	[ESP]	
	4030007130	S.CER C1608 CH 1H 101J-T	[USA]	
	4030007130	S.CER C1608 CH 1H 101J-T	[EXP]	
	4030007130	S.CER C1608 CH 1H 101J-T	[ITR]	
	4030007090	S.CER C1608 CH 1H 470J-T	[UK]	
	4030007130	S.CER C1608 CH 1H 101J-T	[KOR]	
	4030007130	S.CER C1608 CH 1H 101J-T	[AUS]	
	4030007130	S.CER C1608 CH 1H 101J-T	[CHN]	
C342	4030007090	S.CER C1608 CH 1H 470J-T	B	43.7/42.1
C343	4030007140	S.CER C1608 CH 1H 121J-T	B	41.3/39
C344	4030007100	S.CER C1608 CH 1H 560J-T	B	42.7/34.3
C345	4030017660	S.CER ECJ0EC1H330J	T	45.5/37.9
C346	4030017660	S.CER ECJ0EC1H330J	T	45.7/39.7
C347	4030006860	S.CER C1608 JB 1H 102K-T	[EUR] B	48.4/31.7
	4030006860	S.CER C1608 JB 1H 102K-T	[FRA]	
	4030006860	S.CER C1608 JB 1H 102K-T	[ESP]	
	4030006860	S.CER C1608 JB 1H 102K-T	[USA]	
	4030006860	S.CER C1608 JB 1H 102K-T	[EXP]	
	4030006860	S.CER C1608 JB 1H 102K-T	[ITR]	
	4030006860	S.CER C1608 JB 1H 102K-T	[KOR]	
	4030006860	S.CER C1608 JB 1H 102K-T	[AUS]	
	4030006860	S.CER C1608 JB 1H 102K-T	[CHN]	
C401	4030017460	S.CER ECJ0EB1E102K	T	51.1/44.5
C402	4030017460	S.CER ECJ0EB1E102K	T	52.3/48.9
C403	4030017430	S.CER ECJ0EC1H101J	T	47.9/46.1
C411	4030017400	S.CER ECJ0EC1H220J	T	48.1/49.7
C412	4030017630	S.CER ECJ0EC1H120J	T	47.7/47.3
C413	4030017400	S.CER ECJ0EC1H220J	T	46.7/49.4
C451	4030017420	S.CER ECJ0EC1H470J	T	40.2/40.6
C453	4030017460	S.CER ECJ0EB1E102K	T	46.1/46.8
C454	4030017460	S.CER ECJ0EB1E102K	T	35.3/47.9
C456	4030016930	S.CER ECJ0EB1A104K	T	31.2/48
C457	4030017460	S.CER ECJ0EB1E102K	T	35.3/47
C458	4030017460	S.CER ECJ0EB1E102K	T	30.5/49.8
C459	4030017460	S.CER ECJ0EB1E102K	T	27/50.6
C460	4030017780	S.CER ECJ0EB1E472K	T	39.3/50
C461	4030006880	S.CER C1608 JB 1H 472K-T	T	30.7/42.2
C463	4030017420	S.CER ECJ0EC1H470J	T	40.6/41.8

[DDS UNIT]

REF NO.	PARTS NO.	DESCRIPTION	M.	H/V LOCATION
C464	4030017690	S.CER ECJ0EC1H121J	T	41.5/40.2
C465	4030017400	S.CER ECJ0EC1H220J	T	37.7/41.8
C466	4030017500	S.CER ECJ0EC1H040B	T	38.1/40.6
C467	4030017400	S.CER ECJ0EC1H220J	T	37.2/40.6
C468	4030017300	S.CER ECJ0EC1H030B	T	29/48
C469	4030017370	S.CER ECJ0EC1H3R5B	T	29/47.1
C470	4030017380	S.CER ECJ0EC1H050B	T	29/46.2
C471	4030017380	S.CER ECJ0EC1H050B	T	35.6/43.9
C472	4030017660	S.CER ECJ0EC1H330J	T	34.7/41.8
C473	4030017570	S.CER ECJ0EC1H040B	T	34/43
C474	4030017460	S.CER ECJ0EB1E102K	T	41.6/36.7
C475	4030017460	S.CER ECJ0EB1E102K	T	30.5/36.7
C476	4030017780	S.CER ECJ0EB1E472K	T	29.6/40
C477	4030017780	S.CER ECJ0EB1E472K	T	42.4/48.8
C478	4030006880	S.CER C1608 JB 1H 472K-T	B	39.8/39.1
C479	4030006880	S.CER C1608 JB 1H 472K-T	B	38/37.9
C480	4030017630	S.CER ECJ0EC1H120J	T	35.6/41.8
C481	4030017360	S.CER ECJ0EC1H030B	T	35.6/43
C501	4030007080	S.CER C1608 CH 1H 390J-T	B	19/42.6
C502	4030007120	S.CER C1608 CH 1H 820J-T	B	18.3/44.1
C503	4030007060	S.CER C1608 CH 1H 270J-T	B	16.1/43.8
C504	4030017780	S.CER ECJ0EB1E472K	T	16.1/49.3
C505	4030017660	S.CER ECJ0EC1H330J	T	12.6/47.2
C506	4030017620	S.CER ECJ0EC1H100C	T	12.1/48.4
C507	4030017500	S.CER ECJ0EC1H560J	T	11.4/47.2
C508	4030017580	S.CER ECJ0EC1H060C	T	10.5/48.4
C509	4030017420	S.CER ECJ0EC1H470J	T	10.2/47.2
C510	4030017350	S.CER ECJ0EC1H020B	T	8.9/47.5
C511	4030017670	S.CER ECJ0EC1H390J	T	7.7/47.2
C512	4030017780	S.CER ECJ0EB1E472K	T	5.5/50.7
C513	4030017780	S.CER ECJ0EB1E472K	T	15.9/46.8
C551	4030017650	S.CER ECJ0EC1H270J	T	22.5/45.4
C552	4030017500	S.CER ECJ0EC1H560J	T	21.1/45
C553	4030017650	S.CER ECJ0EC1H270J	T	19.2/45.4
C554	4030017780	S.CER ECJ0EB1E472K	T	15.6/43.2
C555	4030017670	S.CER ECJ0EC1H390J	T	14.5/42
C556	4030017350	S.CER ECJ0EC1H020B	T	14/43.2
C557	4030017420	S.CER ECJ0EC1H470J	T	13.1/42
C558	4030017590	S.CER ECJ0EC1H070C	T	10/43.2
C559	4030017420	S.CER ECJ0EC1H470J	T	8.9/42
C560	4030017630	S.CER ECJ0EC1H120J	T	8.4/43.2
C561	4030017660	S.CER ECJ0EC1H330J	T	7.9/42
C562	4030017780	S.CER ECJ0EB1E472K	T	4.9/45.3
C563	4030017780	S.CER ECJ0EB1E472K	T	11.7/41.6
C601	4030017780	S.CER ECJ0EB1E472K	T	24.7/39.9
C602	4030017400	S.CER ECJ0EC1H220J	T	23.3/37.6
C603	4030017360	S.CER ECJ0EC1H030B	T	21.9/37.8
C604	4030017630	S.CER ECJ0EC1H120J	T	13.3/40.4
C605	4030017620	S.CER ECJ0EC1H100C	T	11.6/40.4
C606	4030017660	S.CER ECJ0EC1H330J	T	18.4/36.9
C607	4030017600	S.CER ECJ0EC1H080C	T	17.7/38.1
C608	4030017650	S.CER ECJ0EC1H270J	T	17.2/36.9
C609	4030017640	S.CER ECJ0EC1H150J	T	16.1/38.1
C610	4030017640	S.CER ECJ0EC1H150J	T	15.9/36.9
C611	4030017440	S.CER ECJ0EC1H251J	T	12.1/39.5
C612	4030017510	S.CER ECJ0EC1H680J	T	10.2/40
C613	4030017620	S.CER ECJ0EC1H100C	T	8.2/40.1
C614	4030017640	S.CER ECJ0EC1H150J	T	5.4/40.3
C615	4030017670	S.CER ECJ0EC1H390J	T	6.8/39.9
C616	4030017780	S.CER ECJ0EB1E472K	T	6.8/38.2
C617	4030017780	S.CER ECJ0EB1E472K	T	22/36.4
C618	4030017650	S.CER ECJ0EC1H270J	T	3.3/37.1
C651	4030017620	S.CER ECJ0EC1H100C	T	24.6/34.8
C652	4030017450	S.CER ECJ0EB1E271K	T	23.7/34.8
C653	4030017590	S.CER ECJ0EC1H070C	T	21.7/35.2
C654	4030017680	S.CER ECJ0EC1H820J	T	20.4/34.8
C655	4030017600	S.CER ECJ0EC1H080C	T	19.2/35.2
C656	4030017420	S.CER ECJ0EC1H470J	T	17.9/34.8
C657	4030017630	S.CER ECJ0EC1H120J	T	16.5/35.2
C658	4030017340	S.CER ECJ0EC1H010B	T	13.3/32.8
C659	4030017360	S.CER ECJ0EC1H030B	T	9.4/32.6
C660	4030017640	S.CER ECJ0EC1H150J	T	14.6/32.3
C661	4030017650	S.CER ECJ0EC1H270J	T	12.8/31.6
C662	4030017400	S.CER ECJ0EC1H220J	T	8.5/31.6
C663	4030017380	S.CER ECJ0EC1H050B	T	8/32.8
C664	4030017460	S.CER ECJ0EB1E102K	T	5.4/34.9
C665	4030017390	S.CER ECJ0EC1H180J	T	7.6/31.6
C666	4030017780	S.CER ECJ0EB1E472K	T	11.5/31.2
C701	4030017460	S.CER ECJ0EB1E102K	T	25/29.3
C702	4030017640	S.CER ECJ0EC1H150J	T	23.6/27.2
C703	4030017540	S.CER ECJ0EC1HR75B	T	22.2/27.4
C704	4030017650	S.CER ECJ0EC1H270J	T	18.7/26.4
C705	4030017350	S.CER ECJ0EC1H020B	T	18.2/27.7
C706	4030017400	S.CER ECJ0EC1H220J	T	17.5/26.4
C707	4030017570	S.CER ECJ0EC1H040B	T	16.6/27.2
C708	4030017390	S.CER ECJ0EC1H180J	T	16.3/26.4
C709	4030017590	S.CER ECJ0EC1H070C	T	13.9/30
C710	4030017500	S.CER ECJ0EC1H560J	T	12.5/29.1
C711	4030017380	S.CER ECJ0EC1H050B	T	11.9/30
C712	4030017500	S.CER ECJ0EC1H560J	T	10.7/29.3
C713	4030017380	S.CER ECJ0EC1H050B	T	9.5/29.6
C714	4030017710	S.CER ECJ0EC1H181J	T	8.1/29.7
C715	4030017630	S.CER EC		

[DDS UNIT]

REF NO.	PARTS NO.	DESCRIPTION	M.	H/V LOCATION
C754	4030017500	S.CER ECJ0EC1H560J	T	20.4/23.9
C755	4030017380	S.CER ECJ0EC1H050B	T	19.8/24.8
C756	4030017650	S.CER ECJ0EC1H270J	T	18.6/24.4
C757	4030017600	S.CER ECJ0EC1H080C	T	16.7/24.8
C758	4030017610	S.CER ECJ0EC1H090C	T	15/21.9
C759	4030017530	S.CER ECJ0EC1H0R5B	T	14.1/22.2
C760	4030017640	S.CER ECJ0EC1H150J	T	13.2/21.9
C761	4030017350	S.CER ECJ0EC1H020B	T	9.7/22.2
C762	4030017630	S.CER ECJ0EC1H120J	T	8.6/21.2
C763	4030017360	S.CER ECJ0EC1H030B	T	8.2/22.4
C764	4030017620	S.CER ECJ0EC1H100C	T	7.7/21.2
C765	4030017460	S.CER ECJ0EB1E102K	T	5.3/24.6
C766	4030017780	S.CER ECJ0EB1E472K	T	11.9/20.8
C802	4030017590	S.CER ECJ0EC1H070C	T	26.5/19.3
C803	4030017380	S.CER ECJ0EC1H050B	T	25.2/18.9
C804	4030017570	S.CER ECJ0EC1H040B	T	24.3/18.9
C806	4030017600	S.CER ECJ0EC1H080C	T	24.3/17.2
C807	4030017360	S.CER ECJ0EC1H030B	T	23.4/18.9
C808	4030017660	S.CER ECJ0EC1H330J	T	23/16.7
C809	4030017570	S.CER ECJ0EC1H040B	T	23/17.6
C810	4030017570	S.CER ECJ0EC1H040B	T	21.7/16.6
C811	4030017590	S.CER ECJ0EC1H070C	T	21.2/17.9
C812	4030017610	S.CER ECJ0EC1H090C	T	20.8/16.6
C813	4030017350	S.CER ECJ0EC1H020B	T	19.7/18.7
C814	4030017580	S.CER ECJ0EC1H060C	T	19.7/17
C815	4030017460	S.CER ECJ0EB1E102K	T	20.3/12.5
C816	4030017460	S.CER ECJ0EB1E102K	T	15.1/10.8
C817	4030017730	S.CER ECJ0EB1E471K	T	19/9
C824	4030017590	S.CER ECJ0EC1H070C	T	13/13
C825	4030017380	S.CER ECJ0EC1H050B	T	14.2/13.4
C826	4030017570	S.CER ECJ0EC1H040B	T	13/15.1
C827	4030017620	S.CER ECJ0EC1H100C	T	14.6/15.5
C828	4030017360	S.CER ECJ0EC1H030B	T	13.9/16.4
C829	4030017660	S.CER ECJ0EC1H330J	T	12.7/16.9
C830	4030017570	S.CER ECJ0EC1H040B	T	11.8/17.6
C831	4030017570	S.CER ECJ0EC1H040B	T	11.8/19.2
C832	4030017590	S.CER ECJ0EC1H070C	T	10.3/19.1
C833	4030017610	S.CER ECJ0EC1H090C	T	8.4/19.1
C834	4030017350	S.CER ECJ0EC1H020B	T	8/17.9
C835	4030017580	S.CER ECJ0EC1H060C	T	7/19.5
C838	4030017460	S.CER ECJ0EB1E102K	T	5.3/19.5
C839	4030017780	S.CER ECJ0EB1E472K	T	25.4/14.5
C840	4030017460	S.CER ECJ0EB1E102K	T	6.5/15.6
C841	4030006860	S.CER C1608 JB 1H 102K-T	B	5.1/15.3
C851	4030017780	S.CER ECJ0EB1E472K	T	4.5/14
C901	4030017780	S.CER ECJ0EB1E472K	T	2.4/68.4
C902	4030017430	S.CER ECJ0EC1H101J	T	16/53.2
C951	4030016930	S.CER ECJ0EB1A104K	T	52.3/38.2
C952	4030011600	S.CER C1608 JB 1E 104K-T	T	58.3/46.9
C953	4030016930	S.CER ECJ0EB1A104K	T	54/18.3
C954	4030017780	S.CER ECJ0EB1E472K	T	54.1/28.1
C955	4030016930	S.CER ECJ0EB1A104K	T	52.8/33.2
C956	4030016930	S.CER ECJ0EB1A104K	T	49.2/21
C957	4030016930	S.CER ECJ0EB1A104K	T	53.8/35.9
C958	4030017780	S.CER ECJ0EB1E472K	T	52.8/34.1
C959	4030017780	S.CER ECJ0EB1E472K	T	52.8/35
C960	4030016930	S.CER ECJ0EB1A104K	T	53.5/38.9
C961	4030016930	S.CER ECJ0EB1A104K	T	52.3/39.8
C962	4030016930	S.CER ECJ0EB1A104K	T	52.3/44.6
C963	4030016930	S.CER ECJ0EB1A104K	T	53.5/38
C964	4030017460	S.CER ECJ0EB1E102K	T	55/44.8
C966	4030016930	S.CER ECJ0EB1A104K	T	52.3/41.4
C967	4030016930	S.CER ECJ0EB1A104K	T	52.3/43
C968	4030018960	S.CER C3216 JB 1C 106MT-N	B	42/43.9
C969	4030006880	S.CER C1608 JB 1H 472K-T	B	48.2/23.1
C972	4030018970	S.CER C3225 JB 1C 226MT-N	B	42.2/3.5
C973	4030018970	S.CER C3225 JB 1C 226MT-N	B	29/2.7
C974	4030018970	S.CER C3225 JB 1C 226MT-N	B	32/2.7
C975	4550007140	S.TAN TEESVD 1C 107M12R	B	16.7/4.1
C976	4550007140	S.TAN TEESVD 1C 107M12R	B	23.5/10.5
C977	4550007140	S.TAN TEESVD 1C 107M12R	B	23.5/19.5
C978	4550007140	S.TAN TEESVD 1C 107M12R	B	32.3/10.5
C980	4030004720	S.CER C2012 JB 1H 102K-T	T	55.5/11
C981	4030016930	S.CER ECJ0EB1A104K	T	54.4/12.5
C982	4030006860	S.CER C1608 JB 1H 102K-T	B	14/67.1
C983	4030006860	S.CER C1608 JB 1H 102K-T	B	7.4/74
C991	4030006860	S.CER C1608 JB 1H 102K-T	B	10/68.1
C992	4030006860	S.CER C1608 JB 1H 102K-T	B	7.2/67.3
C993	4030006860	S.CER C1608 JB 1H 102K-T	B	4.2/74
C994	4030006860	S.CER C1608 JB 1H 102K-T	B	5.6/71.3
C995	4030006860	S.CER C1608 JB 1H 102K-T	B	2.2/59.2
C996	4030006860	S.CER C1608 JB 1H 102K-T	B	5/58.8
C997	4030006860	S.CER C1608 JB 1H 102K-T	B	2.9/55
C998	4030006860	S.CER C1608 JB 1H 102K-T	B	3.1/62.6
C1001	4030011600	S.CER C1608 JB 1E 104K-T	T	58.3/48.4
C1051	4030006880	S.CER C1608 JB 1H 472K-T	B	20.2/65.3
C1052	4030006880	S.CER C1608 JB 1H 472K-T	B	19.2/60.3
C1101	4030017780	S.CER ECJ0EB1E472K	T	38.9/52.1
C1102	4030017780	S.CER ECJ0EB1E472K	T	44.2/50.3
C1104	4030017780	S.CER ECJ0EB1E472K	T	42.2/62.2
C1105	4030017780	S.CER ECJ0EB1E472K	T	40.6/59.9
C1106	4030017780	S.CER ECJ0EB1E472K	T	40.4/55.9
C1107	4030017780	S.CER ECJ0EB1E472K	T	43.3/56.9
C1108	4030017460	S.CER ECJ0EB1E102K	T	40.1/62.2
C1109	4030006880	S.CER C1608 JB 1H 472K-T	B	35.1/76.9
C1110	4030017780	S.CER ECJ0EB1E472K	T	33.5/59.6
C1111	4030017780	S.CER ECJ0EB1E472K	T	29.7/59.6
C1112	4030017780	S.CER ECJ0EB1E472K	T	38.2/63.4

[DDS UNIT]

REF NO.	PARTS NO.	DESCRIPTION	M.	H/V LOCATION
C1113	4030017780	S.CER ECJ0EB1E472K	T	37.1/59.7
C1114	4030017780	S.CER ECJ0EB1E472K	T	24.4/60.6
C1115	4030017780	S.CER ECJ0EB1E472K	T	35.3/59.8
C1116	4030017460	S.CER ECJ0EB1E102K	T	23.1/63.7
C1117	4030006860	S.CER C1608 JB 1H 102K-T	B	20.9/63.9
C1151	4030017780	S.CER ECJ0EB1E472K	T	50.5/66.3
C1152	4030017780	S.CER ECJ0EB1E472K	T	46.4/66.3
C1153	4030017780	S.CER ECJ0EB1E472K	T	43.7/68.2
C1154	4030017780	S.CER ECJ0EB1E472K	T	52/66.3
C1155	4030017780	S.CER ECJ0EB1E472K	T	57.9/68.3
RL1101	6330001721	REL ATN207-K1		
J151	6510007020	CON TMP-J01X-V6		
J851	6510018450	CON TMP-S01X-B1		
J951	6510024880	S.CON 52689-3087	T	59.2/35.3
J952	6510024880	S.CON 52689-3087	T	59.2/12.4
J1001	6510003521	CON S04B-EH-S(LF)(SN)		
J1051	6450001791	CON HLJ7000-016010		
J1101	6450001641	CON TCS5044-0141177		
J1151	6450001841	CON TCS7568-4320177		
EP6	6910012350	S.BEA MMZ1608Y 102BT	B	12.9/11
EP251	6910012350	S.BEA MMZ1608Y 102BT	B	33.1/18.7
EP301	6910012350	S.BEA MMZ1608Y 102BT	B	49.7/25
EP302	6910012350	S.BEA MMZ1608Y 102BT	B	32.9/27.8
EP303	6910012350	S.BEA MMZ1608Y 102BT	B	32.9/26.1
EP304	6910012350	S.BEA MMZ1608Y 102BT		
EP305	6910012350	S.BEA MMZ1608Y 102BT	[UK] only	B 41/27.1
EP306	6910012350	S.BEA MMZ1608Y 102BT	[FRA]	B 36.6/26.3
	6910012350	S.BEA MMZ1608Y 102BT	[ESP]	
	6910012350	S.BEA MMZ1608Y 102BT	[USA]	
	6910012350	S.BEA MMZ1608Y 102BT	[EXP]	
	6910012350	S.BEA MMZ1608Y 102BT	[ITR]	
	6910012350	S.BEA MMZ1608Y 102BT	[KOR]	
	6910012350	S.BEA MMZ1608Y 102BT	[AUS]	
	6910012350	S.BEA MMZ1608Y 102BT	[CHN]	
EP451	6910012350	S.BEA MMZ1608Y 102BT	B	39.9/47.8
EP809	6910012350	S.BEA MMZ1608Y 102BT	B	16.6/7.1
EP951	6910012350	S.BEA MMZ1608Y 102BT	B	53.3/24.3
EP952	6910012350	S.BEA MMZ1608Y 102BT	B	50.5/21.7
EP953	6910012350	S.BEA MMZ1608Y 102BT	T	54/43.4
EP954	6910012350	S.BEA MMZ1608Y 102BT	T	54/42.1
EP955	6910012350	S.BEA MMZ1608Y 102BT	T	54.2/40
EP956	6910012350	S.BEA MMZ1608Y 102BT	T	54.6/37
EP957	6910012350	S.BEA MMZ1608Y 102BT	B	39.5/46.1
EP958	6910012350	S.BEA MMZ1608Y 102BT	B	55.9/47.4
EP959	6910012350	S.BEA MMZ1608Y 102BT	B	56.7/32.5
EP960	6910012350	S.BEA MMZ1608Y 102BT	B	56.9/28.4
EP964	6910012350	S.BEA MMZ1608Y 102BT	B	53.3/22.2
EP981	6910012350	S.BEA MMZ1608Y 102BT	T	55.3/14.2
EP1003	6910018930	S.BEA MPZ2012S601A	T	57.2/50.3
EP1004	6910018930	S.BEA MPZ2012S601A	T	53.9/50
EP1051	6910012350	S.BEA MMZ1608Y 102BT	B	20.2/66.8
EP1052	6910012350	S.BEA MMZ1608Y 102BT	B	19.2/58.7
EP1100	6910012350	S.BEA MMZ1608Y 102BT	B	38.7/63.4
EP1101	6910012350	S.BEA MMZ1608Y 102BT	T	27.5/63.3
EP1102	6910012350	S.BEA MMZ1608Y 102BT	T	34.4/62.4
EP1103	6910012350	S.BEA MMZ1608Y 102BT	T	51.1/69.2
EP1104	6910012350	S.BEA MMZ1608Y 102BT	T	56.1/69.2
EP1105	6910014730	S.BEA MPZ2012S331A-T	B	41/67.9
EP1106	6910014730	S.BEA MPZ2012S331A-T	B	34.7/61.8
EP1107	6910014730	S.BEA MPZ2012S331A-T	B	31.4/61.8
EP1108	6910014730	S.BEA MPZ2012S331A-T	B	27/73.6

M.=Mounted side (T: Mounted on the Top side, B: Mounted on the Bottom side)
S.=Surface mount

The combination of this side and the bottom side shows the board layout in the same configuration as the actual P.C.Board.

• VR UNIT
(BOTTOM VIEW)

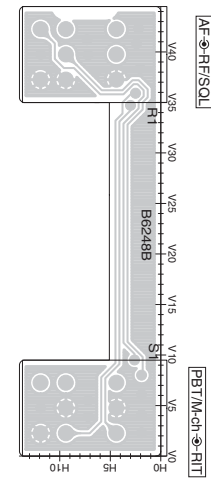

• DRIVER UNIT
(BOTTOM VIEW)

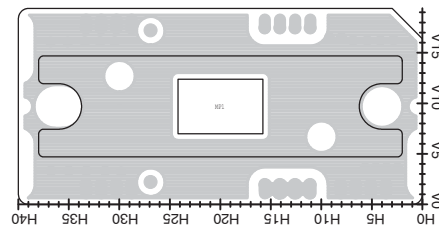

• CONNECT UNIT
(BOTTOM VIEW)

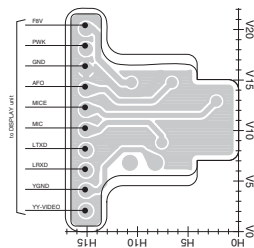

• MAIN UNIT
(BOTTOM VIEW)

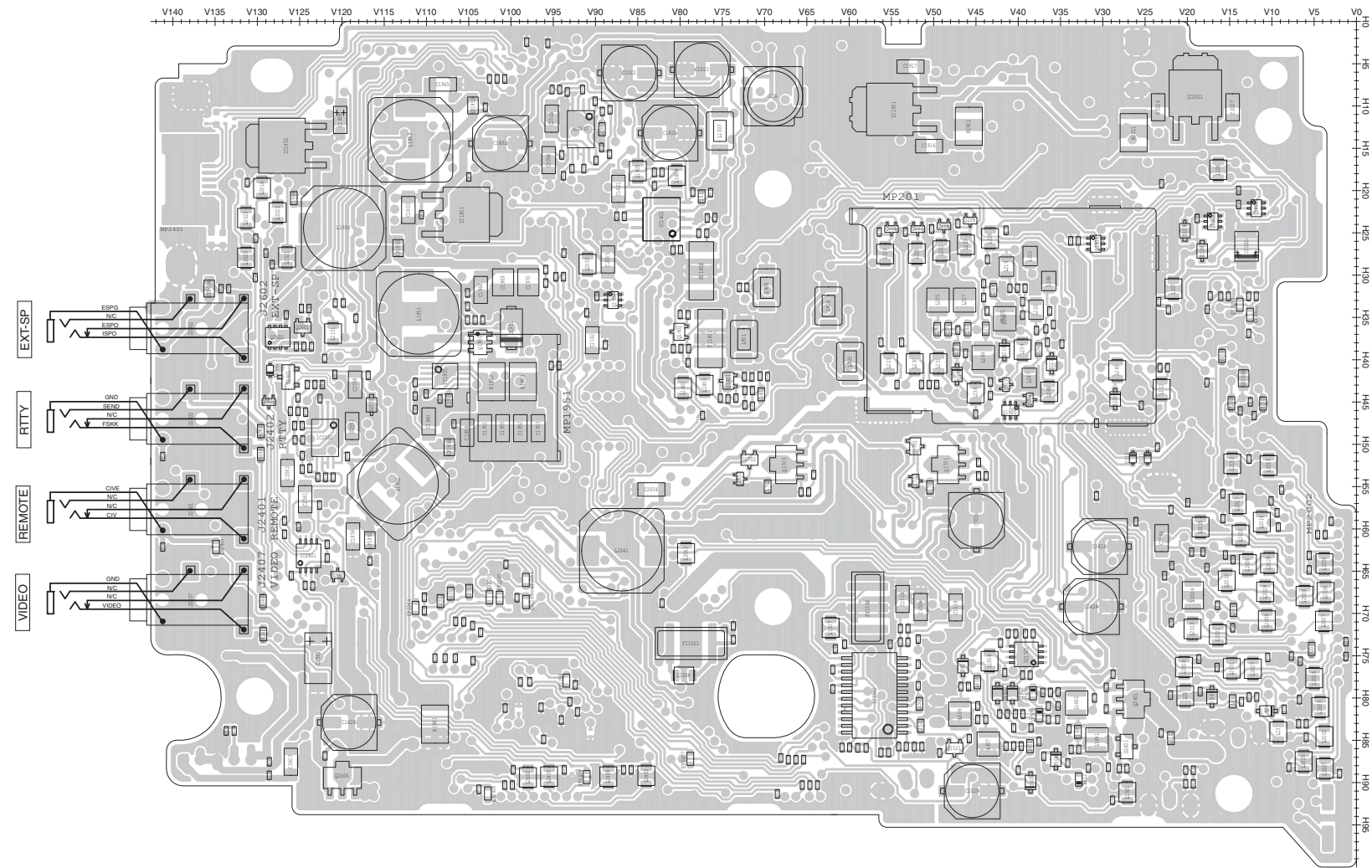

VOLTAGE DIAGRAM

• PA UNIT (1/2)

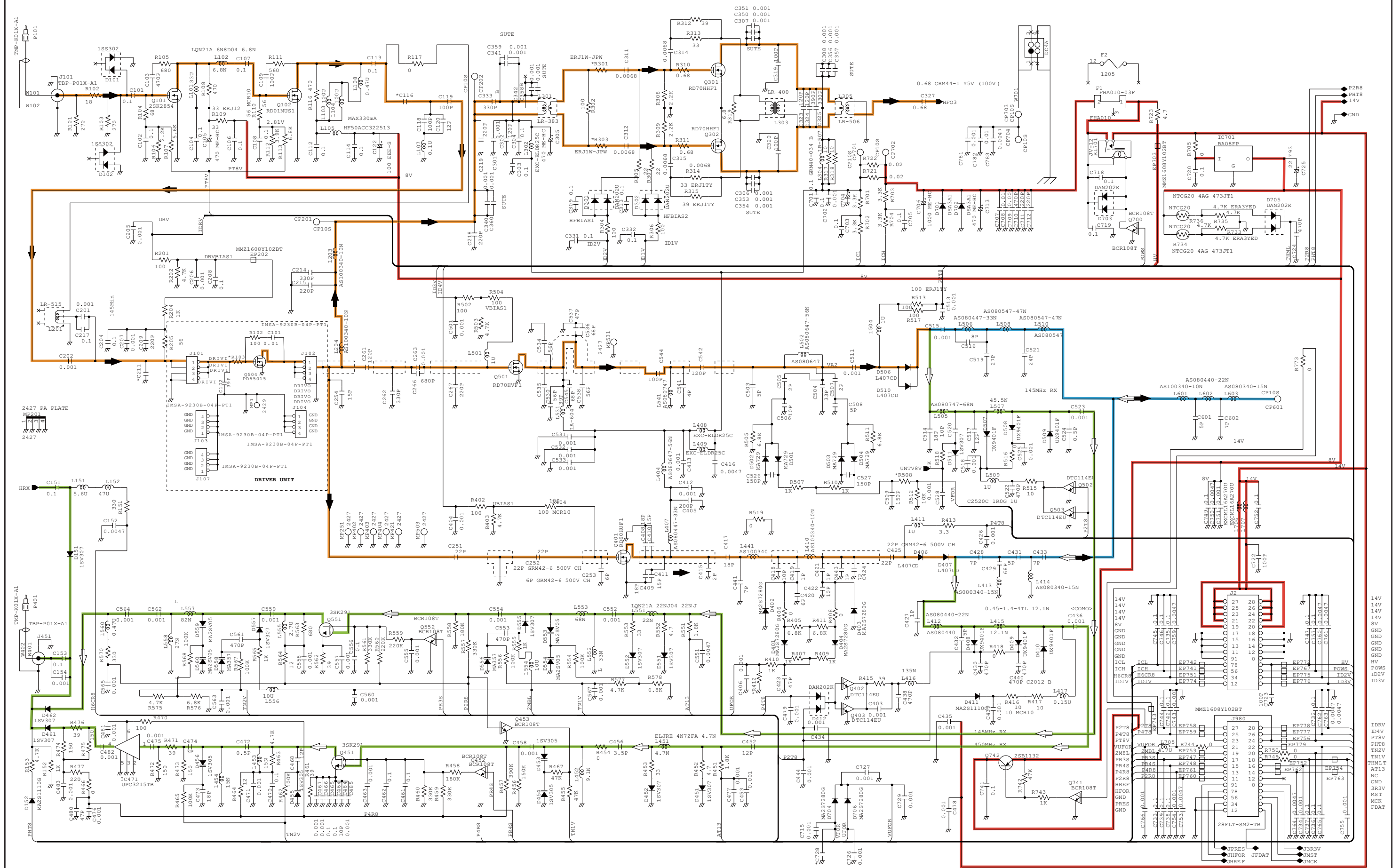

• PA UNIT (2/2)

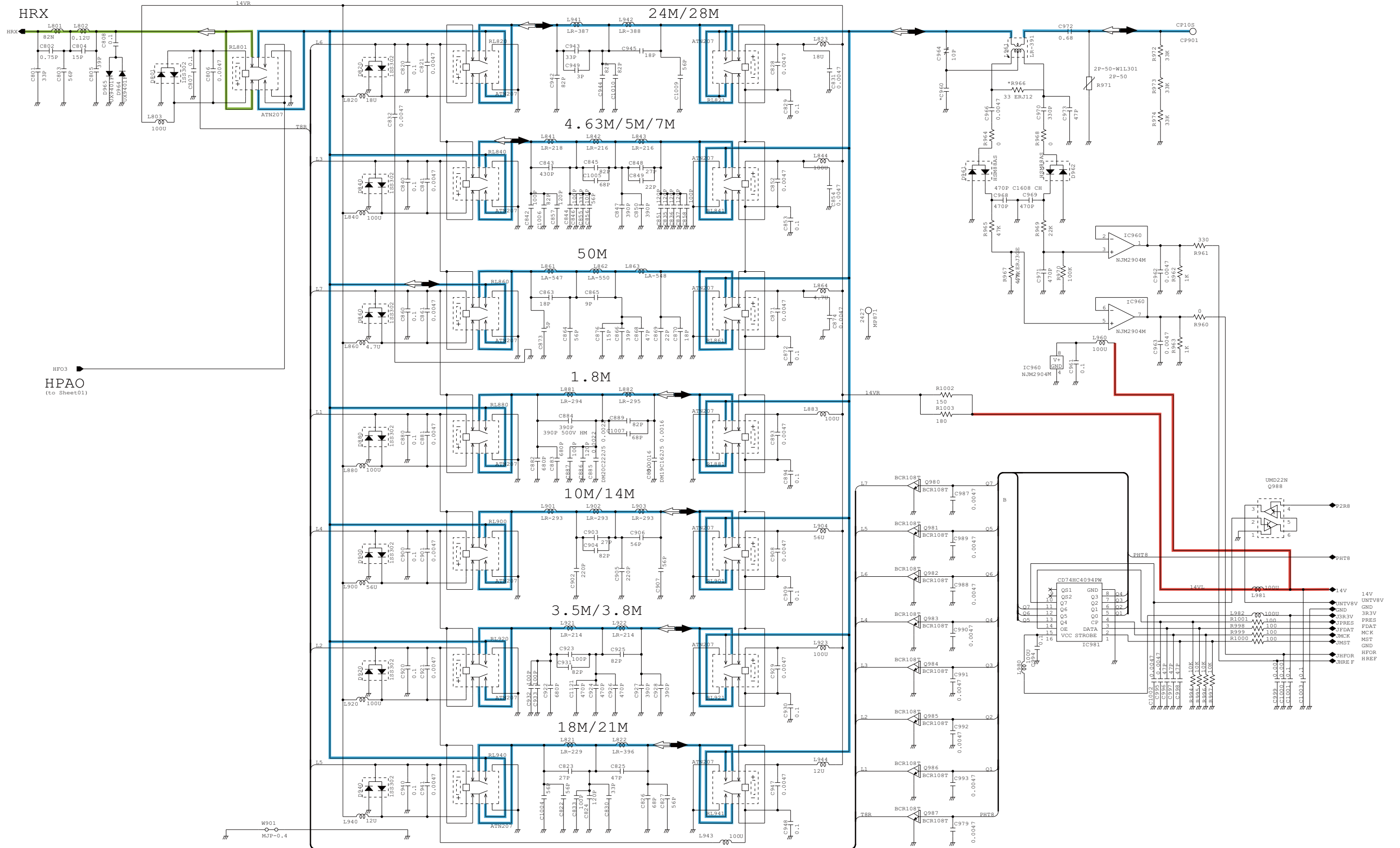

*; Refer to "PARTS LIST."

May. 2009



SERVICE MANUAL ADDENDUM

IC-7000

CONTENTS

PARTS LIST	1
BOARD LAYOUTS	27
VOLTAGE DIAGRAM	29

PARTS LIST

[MAIN UNIT]

REF NO.	PARTS NO.	DESCRIPTION	M.	H/V LOCATION
IC1	1110004080	S.IC UPC2709T-E3	T	75.6/12.7
IC2	1110004101	S.IC TA4001F (TE85L,F)	T	64/18.8
IC3	1110004091	S.IC TA4002F (TE85L,F)	T	48.3/17.4
IC401	1190002052	S.IC SPM5001-TL-E (7000) [EUR]	T	77.5/27.9
	1190002052	S.IC SPM5001-TL-E (7000) [ESP]		
	1190002052	S.IC SPM5001-TL-E (7000) [USA]		
	1190002052	S.IC SPM5001-TL-E (7000) [EXP]		
	1190002052	S.IC SPM5001-TL-E (7000) [ITR]		
	1190002052	S.IC SPM5001-TL-E (7000) [UK]		
	1190002052	S.IC SPM5001-TL-E (7000) [CHN]		
	1190002051	S.IC SPM5001-TL-E [FRA]		
	1190002051	S.IC SPM5001-TL-E [KOR]		
	1190002051	S.IC SPM5001-TL-E [AUS]		
IC421	1110004080	S.IC UPC2709T-E3	T	86.4/19.4
IC801	1110004080	S.IC UPC2709T-E3	T	86/57.4
IC1101	1110006730	S.IC NJM2594V-TE1-#ZZZB	T	5/83.3
IC1201	1130006221	S.IC TC4W53FU(TE12L,F)	T	24.2/81.6
IC1202	1130006221	S.IC TC4W53FU(TE12L,F)	T	19.8/81.4
IC1203	1110006570	S.IC TS462CPT	T	12.8/81.7
IC1301	1110005461	S.IC TA4107F(TE12L,F)	T	13.7/63.4
IC1401	1110006541	S.IC LA1225M-TLM-E	B	23.4/82.2
IC1501	1110006530	S.IC TA4019F(TE12L,F)	B	74.8/39
IC1502	1110005040	S.IC M52342FP 600C	B	79.7/57
IC1601	1110005320	S.IC NJM13403V-TE1-#ZZZB	T	8.6/41.5
IC1801	1180002020	S.REG BA033FP-E2	B	22.8/106.5
IC1901	1180001251	S.IC TA7808F(TE16L,Q)	B	10.4/55.2
IC1951	1190002120	S.IC XC9201D09AKR	B	41.9/107.8
IC1952	1180002020	S.REG BA033FP-E2	B	14.7/125.8
IC2001	1180001251	S.IC TA7808F(TE16L,Q)	B	8.5/19
IC2007	1110006570	S.IC TS462CPT	T	15.8/121
IC2101	1110005320	S.IC NJM13403V-TE1-#ZZZB	T	28.5/118
IC2102	1110005320	S.IC NJM13403V-TE1-#ZZZB	T	49.5/111.9
IC2103	1110005140	S.IC NJM3403AV-TE1-#ZZZB	T	49.5/121.2
IC2151	1130012720	S.IC CD74HC4094PWR	T	47.1/95.9
IC2152	1130012720	S.IC CD74HC4094PWR	T	37.9/95.9
IC2153	1130012720	S.IC CD74HC4094PWR	T	28.1/95.8
IC2154	1130012720	S.IC CD74HC4094PWR	T	28.2/101.5
IC2155	1110006680	S.IC BH2221FV-E2	T	38.2/118.1
IC2156	1110009100	S.IC BU0452BCFV-E2	T	10.1/107.6
IC2231	1110006640	S.IC NJM2244M-TE1-#ZZZB	T	34.7/109.4
IC2251	1130008511	S.IC TCTW53FU(TE12L,F)	T	16.7/89.5
IC2501	1110006570	S.IC TS462CPT	B	12.7/91.7
IC2551	1110006570	S.IC TS462CPT	B	49.2/122
IC2601	1130006221	S.IC TC4W53FU(TE12L,F)	B	63.2/123.9
IC2602	1110003091	IC LA4425A-E		
Q101	1530003091	S.TRA 2SC4213-B(E85R,F)	T	11.2/17.5
Q102	1590003940	S.TRA RN1105(TE85L,F)	T	20.7/5.6
Q103	1590003930	S.TRA UMD22N TR	T	38.4/20.2
Q201	1590003940	S.TRA RN1105(TE85L,F)	T	16.1/31.1
Q202	1590003940	S.TRA RN1105(TE85L,F)	T	23.5/28.5
Q204	1590003940	S.TRA RN1105(TE85L,F)	B	44.7/38.6
Q205	1590003940	S.TRA RN1105(TE85L,F)	T	42.9/61.5
Q206	1590003940	S.TRA RN1105(TE85L,F)	B	24.5/55
Q207	1590003940	S.TRA RN1105(TE85L,F)	B	24.5/51.9
Q208	1590003940	S.TRA RN1105(TE85L,F)	B	24.2/48.8
Q209	1590003940	S.TRA RN1105(TE85L,F)	B	23.5/45.7
Q210	1590003940	S.TRA RN1105(TE85L,F)	B	42.9/41.4
Q211	1530003851	S.TRA 2SC5551F-TD-E	T	27.6/30.1
Q301	1530003851	S.TRA 2SC5551F-TD-E	T	56.7/32.4
Q402	1590003930	S.TRA UMD22N TR	T	82.8/22.8
Q403	1590003930	S.TRA UMD22N TR	T	69.7/23.6
Q502	1530003851	S.TRA 2SC5551F-TD-E	T	83/37.1
Q701	1580000780	S.FET 3SK195(TE85L,F)	T	62/56.5
Q702	1580000780	S.FET 3SK195(TE85L,F)	T	54.6/51.8
Q901	1580000780	S.FET 3SK195(TE85L,F)	T	36.6/65.7
Q902	1580000780	S.FET 3SK195(TE85L,F)	T	35.9/73.2
Q1001	1580000780	S.FET 3SK195(TE85L,F)	T	17.9/76
Q1201	1590003930	S.TRA UMD22N TR	T	28/78.6
Q1401	1530002060	S.TRA 2SC4081 T106 R	B	42.5/74.3
Q1402	1530002060	S.TRA 2SC4081 T106 R	B	36.7/80.1
Q1501	1590003530	S.TRA BCR08PN	T	30.6/78.5
Q1521	1530002060	S.TRA 2SC4081 T106 R	B	86.6/48.6
Q1601	1530003091	S.TRA 2SC4213-B(E85R,F)	T	8.3/52.9
Q1602	1590001870	S.TRA DTA114EE TL	T	4.5/53
Q1603	1590003940	S.TRA RN1105(TE85L,F)	T	2.8/40.7
Q1604	1510000771	S.TRA 2SA1586-GR(TE85L,F)	T	5.1/32.7
Q1606	1560001260	S.FET 2SK3018 T106	T	12.5/36.8
Q1701	1540000441	S.TRA 2SD1619T-TD-E	B	52.4/48.2
Q1702	1590003940	S.TRA RN1105(TE85L,F)	B	54.3/52.1
Q1703	1540000441	S.TRA 2SD1619T-TD-E	B	52.4/67.4
Q1704	1590003940	S.TRA RN1105(TE85L,F)	B	54.1/72.9
Q1901	1590003930	S.TRA UMD22N TR	T	35.8/78.5
Q1902	1590003930	S.TRA UMD22N TR	T	33.3/78.5
Q1903	1590003930	S.TRA UMD22N TR	B	23.6/17
Q1904	1590003930	S.TRA UMD22N TR	B	32.9/87.9
Q1905	1590003930	S.TRA UMD22N TR	B	46/40.9
Q1906	1590003930	S.TRA UMD22N TR	B	26.3/30.8
Q1907	1590003930	S.TRA UMD22N TR	T	40.9/78.5
Q1908	1590003930	S.TRA UMD22N TR	T	38.3/78.5

[MAIN UNIT]

REF NO.	PARTS NO.	DESCRIPTION	M.	H/V LOCATION
Q1909	1590003930	S.TRA UMD22N TR	B	22.1/11.8
Q1960	1550000090	S.FET RSQ035P03TR	B	37.9/103.6
Q2150	1590003930	S.TRA UMD22N TR	T	48.4/100.1
Q2151	1520000460	S.TRA 2SB1132 T100 R	T	55.3/103.8
Q2152	1520000460	S.TRA 2SB1132 T100 R	T	21.3/111
Q2153	1520000460	S.TRA 2SB1132 T100 R	T	49.8/104.5
Q2154	1590003930	S.TRA UMD22N TR	T	44.7/100.1
Q2155	1590003930	S.TRA UMD22N TR	T	39.9/100.1
Q2156	1590003940	S.TRA RN1105(TE85L,F)	T	58.9/104.5
Q2157	1590003940	S.TRA RN1105(TE85L,F)	T	25.4/109.7
Q2158	1590003940	S.TRA RN1105(TE85L,F)	T	45.5/107.1
Q2159	1590003930	S.TRA UMD22N TR	T	6.7/118.2
Q2160	1590003930	S.TRA UMD22N TR	T	7.7/122.2
Q2231	1590003940	S.TRA RN1105(TE85L,F)	T	4.7/121.7
Q2232	1590003930	S.TRA UMD22N TR	T	57.3/114.8
Q2233	1590003930	S.TRA UMD22N TR	T	54.7/115.7
Q2301	1530002060	S.TRA 2SC4081 T106 R	T	30.6/109
Q2401	1540000441	S.TRA 2SD1619T-TD-E	B	80.1/26.4
Q2601	1560001260	S.FET 2SK3018 T106	B	36.2/124.6
Q2602	1560001221	S.FET ECH8301-TL-E	B	37.3/127.6
Q2603	1530002060	S.TRA 2SC4081 T106 R	T	65.3/111.3
Q2605	1590003940	S.TRA RN1105(TE85L,F)	T	11.7/112.7
Q2606	1540000451	S.TRA 2SD1623T-TD-E	B	89.5/119.9
Q2607	1590003940	S.TRA RN1105(TE85L,F)	B	65.4/120.5
Q2608	1590003940	S.TRA RN1105(TE85L,F)	B	45/128.6
D1	1750000581	S.DIO 1SV307(TPH3,F)	T	70.1/16.6
D2	1750000581	S.DIO 1SV307(TPH3,F)	T	70.3/14.8
D3	1750000581	S.DIO 1SV307(TPH3,F)	T	45.2/19.8
D4	1750000581	S.DIO 1SV307(TPH3,F)	T	41.9/19
D5	1750000581	S.DIO 1SV307(TPH3,F)	T	70.3/18.3
D6	1790000620	S.DIO MA77(TX)	B	79.8/17.1
D7	1790000620	S.DIO MA77(TX)	T	78/15.8
D8	1790000620	S.DIO MA77(TX)	B	81.5/10.6
D9	1790000620	S.DIO MA77(TX)	T	79/11.5
D10	1750000581	S.DIO 1SV307(TPH3,F)	T	42.4/20.9
D101	1750000581	S.DIO 1SV307(TPH3,F)	T	13.3/22.5
D102	1750000581	S.DIO 1SV307(TPH3,F)	T	15.7/19.2
D103	1750000581	S.DIO 1SV307(TPH3,F)	T	20.3/8.7
D104	1750000581	S.DIO 1SV307(TPH3,F)	T	34.7/17.9
D105	1750000581	S.DIO 1SV307(TPH3,F)	T	23.1/12.7
D106	1750000581	S.DIO 1SV307(TPH3,F)	T	29.6/21
D107	1750000581	S.DIO 1SV307(TPH3,F)	T	44/23.6
D108	1750000950	S.DIO MA732(TX)	B	27.1/18.2
D109	1750000950	S.DIO MA732(TX)	B	24.7/20.3
D110	1790001240	S.DIO MA2S728-(TX)	B	51.6/26.4
D111	1790001240	S.DIO MA2S728-(TX)	B	51.6/24.7
D112	1750000581	S.DIO 1SV307(TPH3,F)	T	15.7/20.9
D113	1750000581	S.DIO 1SV307(TPH3,F)	T	10.2/19.7
D114	1790001250	S.DIO MA2S111-(TX)	T	35.7/21.3
D203	1750000581	S.DIO 1SV307(TPH3,F)	T	19.3/35.7
D204	1750000581	S.DIO 1SV307(TPH3,F)	T	25.7/58.2
D205	1750000581	S.DIO 1SV307(TPH3,F)	T	25.7/56.3
D208	1750000581	S.DIO 1SV307(TPH3,F)	T	25.7/53.4
D209	1750000581	S.DIO 1SV307(TPH3,F)	T	25.7/50.6
D210	1750000581	S.DIO 1SV307(TPH3,F)	T	25.7/47.7
D211	1750000581	S.DIO 1SV307(TPH3,F)	T	25.7/44.8
D212	1750000581	S.DIO 1SV307(TPH3,F)	T	25.7/39.2
D213	1750000581	S.DIO 1SV307(TPH3,F)	T	25.7/41.5
D214	1750000581	S.DIO 1SV307(TPH3,F)	T	47.7/59.3
D215	1750000581	S.DIO 1SV307(TPH3,F)	T	47.7/56.3
D216	1750000581	S.DIO 1SV307(TPH3,F)	T	47.9/53.6
D217	1750000581	S.DIO 1SV307(TPH3,F)	T	47.8/49.7
D218	1750000581	S.DIO 1SV307(TPH3,F)	B	41.7/47.2
D219	1750000581	S.DIO 1SV307(TPH3,F)	B	38.9/41.6
D220	1750000581	S.DIO 1SV307(TPH3,F)	B	44.6/28.5
D221	1750000581	S.DIO 1SV307(TPH3,F)	B	40.4/36
D301	1750000581	S.DIO 1SV307(TPH3,F)	T	47.3/28.5
D302	1750000581	S.DIO 1SV307(TPH3,F)	T	49.5/30.3
D303	1750000581	S.DIO 1SV307(TPH3,F)	T	64.1/29.9
D304	1750000581	S.DIO 1SV307(TPH3,F)	T	62.4/35.2
D305	1750000581	S.DIO 1SV307(TPH3,F)	T	73.3/35.2
D306	1750000581	S.DIO 1SV307(TPH3,F)	T	64.5/25.7
D401	1790001240	S.DIO MA2S728-(TX)	T	86.6/24.9
D501	1750000531	S.DIO 1SV271(PH3,F)	T	90.6/32.2
D502	1750000581	S.DIO 1SV307(TPH3,F)	T	86.2/31.4
D503	1750000581	S.DIO 1SV307(TPH3,F)	T	89.4/29.7
D504	1750000531	S.DIO 1SV271(PH3,F)	T	89.7/37.7
D505	1750000581	S.DIO 1SV307(TPH3,F)	T	86.7/40.1
D506	1750000581	S.DIO 1SV307(TPH3,F)	B	87.2/35.5
D601	1750000581	S.DIO 1SV307(TPH3,F)	B	90/38.5
D602	1750000581	S.DIO 1SV307(TPH3,F)	T	92.4/41.5
D603	1750000581	S.DIO 1SV307(TPH3,F)	B	76.2/46.5
D604	1750000581	S.DIO 1SV307(TPH3,F)	T	66.7/43.7
D701	1750000581	S.DIO 1SV307(TPH3,F)	T	61.2/43.7
D702	1750000581	S.DIO 1SV307(TPH3,F)	T	65.1/41.3
D703	1750000581	S.DIO 1SV307(TPH3,F)	T	62.7/61.4
D704	1750000581	S.DIO 1SV307(TPH3,F)	T	62.7/63.2
D801	1750000431	S.DIO HSB88WSTR-E	T	74.1/60.3
D802	1750000581	S.DIO 1SV307(TPH3,F)	T	63/73.3

M.=Mounted side (T: Mounted on the Top side, B: Mounted on the Bottom side)
S.=Surface mount

[MAIN UNIT]

REF NO.	PARTS NO.	DESCRIPTION	M.	H/V LOCATION
D803	1750000581	S.DIO 1SV307(TPH3,F)	T	65.5/64.6
D903	1750000581	S.DIO 1SV307(TPH3,F)	T	39.5/69.4
D904	1750000581	S.DIO 1SV307(TPH3,F)	T	39.5/72.8
D1301	1750000581	S.DIO 1SV307(TPH3,F)	T	12.8/72.6
D1302	1750000581	S.DIO 1SV307(TPH3,F)	T	13.9/70.8
D1521	1750000531	S.DIO 1SV271(PH3,F)	B	79.4/40.7
D1522	1750000531	S.DIO 1SV271(PH3,F)	B	79.4/42.4
D1601	1790001240	S.DIO MA2S728-(TX)	T	15.1/48.7
D1602	1790001240	S.DIO MA2S728-(TX)	T	18.3/53.1
D1604	1790001250	S.DIO MA2S111-(TX)	T	7.7/31.5
D1605	1790001250	S.DIO MA2S111-(TX)	T	7.7/32.8
D1606	1790001250	S.DIO MA2S111-(TX)	T	14.1/44.8
D1607	1790001250	S.DIO MA2S111-(TX)	T	14.1/43.5
D1608	1790001250	S.DIO MA2S111-(TX)	T	14.1/42.2
D1609	1790001330	S.ZEN MA8036-L(TX)	T	7.5/29.9
D1610	1790001250	S.DIO MA2S111-(TX)	T	12.3/34.9
D1701	1790001670	S.DIO RB706F-40T106	B	50.2/52.2
D1702	1790001670	S.DIO RB706F-40T106	B	51.8/71.8
D1951	1750001110	S.DIO SM240A-T	B	36.2/99.9
D2151	1790001250	S.DIO MA2S111-(TX) [USA]	T	39/87.1
	1790001250	S.DIO MA2S111-(TX) [KOR]		
	1790001250	S.DIO MA2S111-(TX) [AUS]		
D2153	1790001250	S.DIO MA2S111-(TX) [USA]	T	36.5/87.1
	1790001250	S.DIO MA2S111-(TX) [KOR]		
D2154	1790001250	S.DIO MA2S111-(TX)	T	36.5/88.4
D2155	1790001250	S.DIO MA2S111-(TX)	T	36.6/89.7
D2156	1790001250	S.DIO MA2S111-(TX)	T	39/90.5
D2157	1790001250	S.DIO MA2S111-(TX) [EUR]	T	48.5/87.1
	1790001250	S.DIO MA2S111-(TX) [ESP]		
	1790001250	S.DIO MA2S111-(TX) [USA]		
	1790001250	S.DIO MA2S111-(TX) [EXP]		
	1790001250	S.DIO MA2S111-(TX) [ITR]		
	1790001250	S.DIO MA2S111-(TX) [UK]		
	1790001250	S.DIO MA2S111-(TX) [KOR]		
	1790001250	S.DIO MA2S111-(TX) [AUS]		
	1790001250	S.DIO MA2S111-(TX) [CHN]		
D2158	1790001250	S.DIO MA2S111-(TX)	T	48.5/88.4
D2159	1790001250	S.DIO MA2S111-(TX)	T	48.5/89.7
D2160	1790001250	S.DIO MA2S111-(TX)	T	48.5/91
D2162	1790001250	S.DIO MA2S111-(TX) [USA] only	T	46/88.4
D2163	1790001250	S.DIO MA2S111-(TX) [EUR]	T	46/89.7
	1790001250	S.DIO MA2S111-(TX) [FRA]		
	1790001250	S.DIO MA2S111-(TX) [ESP]		
	1790001250	S.DIO MA2S111-(TX) [ITR]		
	1790001250	S.DIO MA2S111-(TX) [UK]		
D2166	1790001250	S.DIO MA2S111-(TX) [ESP]	T	29.4/88.2
	1790001250	S.DIO MA2S111-(TX) [ITR]		
	1790001250	S.DIO MA2S111-(TX) [KOR]		
D2168	1790001250	S.DIO MA2S111-(TX) [EUR]	T	29.4/90.6
	1790001250	S.DIO MA2S111-(TX) [ESP]		
	1790001250	S.DIO MA2S111-(TX) [ITR]		
	1790001250	S.DIO MA2S111-(TX) [UK]		
	1790001250	S.DIO MA2S111-(TX) [AUS]		
D2169	1790001250	S.DIO MA2S111-(TX) [EUR]	T	26.9/87.1
	1790001250	S.DIO MA2S111-(TX) [ESP]		
	1790001250	S.DIO MA2S111-(TX) [USA]		
	1790001250	S.DIO MA2S111-(TX) [EXP]		
	1790001250	S.DIO MA2S111-(TX) [ITR]		
	1790001250	S.DIO MA2S111-(TX) [UK]		
	1790001250	S.DIO MA2S111-(TX) [KOR]		
	1790001250	S.DIO MA2S111-(TX) [AUS]		
	1790001250	S.DIO MA2S111-(TX) [CHN]		
D2170	1790001250	S.DIO MA2S111-(TX) [KOR]	T	26.9/88.4
	1790001250	S.DIO MA2S111-(TX) [EUR]		
	1790001250	S.DIO MA2S111-(TX) [USA]		
	1790001250	S.DIO MA2S111-(TX) [EXP]		
	1790001250	S.DIO MA2S111-(TX) [UK]		
	1790001250	S.DIO MA2S111-(TX) [KOR]		
	1790001250	S.DIO MA2S111-(TX) [AUS]		
	1790001250	S.DIO MA2S111-(TX) [CHN]		
D2172	1790001250	S.DIO MA2S111-(TX)	T	26.9/91
D2173	1790001250	S.DIO MA2S111-(TX)	T	6.4/120.2
D2174	1790001250	S.DIO MA2S111-(TX)	T	52/88.2
D2175	1790001250	S.DIO MA2S111-(TX)	T	52/87
D2201	1730002340	S.ZEN MA8047-M(TX)	T	10.5/122.8
D2205	1790001010	S.ZEN MA8043-L(TX)	T	13.5/115.2
D2211	1790001010	S.ZEN MA8043-L(TX)	T	21.5/118
D2231	1160000070	S.DIO DAN202K T146	T	57.6/117.8
D2232	1790001670	S.DIO RB706F-40T106	T	56.8/112.2
D2401	1160000070	S.DIO DAN202K T146	B	85.7/27.2
D2402	1790001250	S.DIO MA2S111-(TX)	T	63.5/113.2
D2551	1790001140	S.ZEN MA8039-L(TX)	B	45.3/116.5
D2601	1160000070	S.DIO DAN202K T146	B	42/126.3
D2602	1790001250	S.DIO MA2S111-(TX)	B	41.2/128.5
FI2	2040001420	S.LC LFB32440MSC1-955 (LFSC25N12B0)	T	59.3/13.9
FI3	2040001420	S.LC LFB32440MSC1-955 (LFSC25N12B0)	T	53.3/13.4
FI601	2010002640	S.XTA DSF753SDF 124.487 MHz (FL-374)	T	81/43.7
FI901	2020002011	S.CER CFUKG455KF4A-R0	T	44.7/69.7
FI1001	2020002011	S.CER CFUKG455KF4A-R0	T	27.8/66.9

[MAIN UNIT]

REF NO.	PARTS NO.	DESCRIPTION	M.	H/V LOCATION
FI1401	2020001810	S.CER SFECV10M7FA00-R0 (SFECV10.7MA5S)	B	37.5/76.4
FI1402	2020001810	S.CER SFECV10M7FA00-R0 (SFECV10.7MA5S)	B	29.5/77.5
FI1501	2040001561	SAW TSB6321DL [EUR]		
	2040001561	SAW TSB6321DL [FRA]		
	2040001561	SAW TSB6321DL [ESP]		
	2040001571	SAW TSB6221DL [USA]		
	2040001561	SAW TSB6321DL [EXP]		
	2040001561	SAW TSB6321DL [ITR]		
	2040001561	SAW TSB6321DL [UK]		
	2040001571	SAW TSB6221DL [KOR]		
	2040001561	SAW TSB6321DL [AUS]		
	2040001561	SAW TSB6321DL [CHN]		
FI1502	2020001720	S.CER SF5KA5M50CF00-R1 (SF5CC5.5MC2-T) [EUR]	B	69.3/57.8
	2020001720	S.CER SF5KA5M50CF00-R1 (SF5CC5.5MC2-T) [FRA]		
	2020001720	S.CER SF5KA5M50CF00-R1 (SF5CC5.5MC2-T) [ESP]		
	2020001700	S.CER SF5KA4M50CF00-R1 (SF5CC4.5MC2-T) [USA]		
	2020001720	S.CER SF5KA5M50CF00-R1 (SF5CC5.5MC2-T) [EXP]		
	2020001720	S.CER SF5KA5M50CF00-R1 (SF5CC5.5MC2-T) [ITR]		
	2020001720	S.CER SF5KA5M50CF00-R1 (SF5CC5.5MC2-T) [UK]		
	2020001700	S.CER SF5KA4M50CF00-R1 (SF5CC4.5MC2-T) [KOR]		
	2020001720	S.CER SF5KA5M50CF00-R1 (SF5CC5.5MC2-T) [AUS]		
	2020001720	S.CER SF5KA5M50CF00-R1 (SF5CC5.5MC2-T) [CHN]		
FI1503	2020001730	S.CER TP5KA5M50B00-R1 (TP5CC5.5MB-TC1) [EUR]	B	73.5/78.7
	2020001730	S.CER TP5KA5M50B00-R1 (TP5CC5.5MB-TC1) [FRA]		
	2020001730	S.CER TP5KA5M50B00-R1 (TP5CC5.5MB-TC1) [ESP]		
	2020001710	S.CER TP5KA4M50B00-R1 (TP5CC4.5MB-TC1) [USA]		
	2020001730	S.CER TP5KA5M50B00-R1 (TP5CC5.5MB-TC1) [EXP]		
	2020001730	S.CER TP5KA5M50B00-R1 (TP5CC5.5MB-TC1) [ITR]		
	2020001730	S.CER TP5KA5M50B00-R1 (TP5CC5.5MB-TC1) [UK]		
	2020001710	S.CER TP5KA4M50B00-R1 (TP5CC4.5MB-TC1) [KOR]		
	2020001730	S.CER TP5KA5M50B00-R1 (TP5CC5.5MB-TC1) [AUS]		
	2020001730	S.CER TP5KA5M50B00-R1 (TP5CC5.5MB-TC1) [CHN]		
L3	6200004480	S.COI MLF1608D R82K-T	T	76.4/10.1
L4	6200002041	S.COI NLV25T-101J	T	75.6/18.9
L5	6200004780	S.COI MLF1608A 1R5K-T	T	67.4/18.6
L8	6200010910	S.COI LQW18AN56NG00D	T	57/16.6
L10	6200010910	S.COI LQW18AN56NG00D	T	57.3/17.9
L11	6200011780	S.COI LQW18ANR18G00D	T	56.5/20
L12	6200011680	S.COI LQW18ANR12G00D	T	53.8/19.8
L13	6200011780	S.COI LQW18ANR18G00D	T	52.8/18.5
L14	6200009590	S.COI MLG1608B 18NJ-T	T	57.3/11.4
L16	6200005721	S.COI ELJRE 33NGFA [EUR]	T	49.6/19.8
	6200005721	S.COI ELJRE 33NGFA [FRA]		
	6200005721	S.COI ELJRE 33NGFA [ESP]		
	6200005721	S.COI ELJRE 33NGFA [USA]		
	6200005721	S.COI ELJRE 33NGFA [EXP]		
	6200005721	S.COI ELJRE 33NGFA [ITR]		
	6200006991	S.COI ELJRE 56NGFA [UK]		
	6200005721	S.COI ELJRE 33NGFA [KOR]		
	6200005721	S.COI ELJRE 33NGFA [AUS]		
	6200005721	S.COI ELJRE 33NGFA [CHN]		
L18	6200005041	S.COI NLV25T-220J	T	73.4/9.5
L19	6200002041	S.COI NLV25T-101J	T	66.9/14.8
L21	6200006671	S.COI ELJRE 68NGFA	B	80.4/14.6
L22	6200002861	S.COI NLV25T-4R7J	B	79.7/20.2
L23	6200002861	S.COI NLV25T-4R7J	B	84/9.2
L24	6200011520	S.COI SLF7045F-102MR14-PF	B	8.8/69
L101	6200002041	S.COI NLV25T-101J	T	15.7/17
L102	6200002041	S.COI NLV25T-101J	T	20.4/10.9
L103	6200010800	S.COI C2520C-4R7G-A	T	24.4/7.4
L104	6200010800	S.COI C2520C-4R7G-A	T	27.9/10
L105	6200002041	S.COI NLV25T-101J	T	28.1/12.8
L106	6200002041	S.COI NLV25T-101J	B	17.5/16.3
L107	6200002041	S.COI NLV25T-101J	B	31.6/21.6
L108	6200002041	S.COI NLV25T-101J	T	25.2/20.8
L109	6200001831	S.COI NLV32T-100J	T	28.5/15.6
L110	6200003121	S.COI NLV32T-8R2J	T	21.1/15.1
L112	6200002041	S.COI NLV25T-101J	B	43.5/23
L113	6200002041	S.COI NLV25T-101J	T	7.2/17.6
L114	6200002041	S.COI NLV25T-101J	T	7.2/15
L116	6200003131	S.COI NLV32T-120J	T	28.5/18.6
L117	6200001831	S.COI NLV32T-100J	T	21.1/18.1
L204	6200002041	S.COI NLV25T-101J	T	18.7/32.9

M.=Mounted side (T: Mounted on the Top side, B: Mounted on the Bottom side)
S.=Surface mount

[MAIN UNIT]

REF NO.	PARTS NO.	DESCRIPTION	M.	H/V LOCATION
L205	6200010740	S.COI C2520C-R27G-A	T	20.2/38.1
L207	6200010680	S.COI C2520C-R22G-A (0.22U)	T	21.8/41.3
L213	6200005011	S.COI NLV25T-100J	T	22.7/34.9
L215	6200010330	S.COI C2012C-R18G-A	B	27.7/38.6
L217	6200009990	S.COI C2012C-R22G-A	T	22.7/32.5
L218	6200005011	S.COI NLV25T-100J	B	25.6/43.3
L219	6200011050	S.COI C2012C-R12G-A	B	29.4/41.4
L220	6200010320	S.COI C2012C-R15G-A	B	34.1/37.9
L221	6200002041	S.COI NLV25T-101J	T	15.1/52.6
L222	6200002041	S.COI NLV25T-101J	T	45.6/61.4
L223	6200002041	S.COI NLV25T-101J	B	40.4/55.3
L224	6200002041	S.COI NLV25T-101J	B	27.5/55.7
L225	6200002041	S.COI NLV25T-101J	B	27.4/52
L226	6200002861	S.COI NLV25T-4R7J	T	40.3/57.6
L227	6200003711	S.COI NLV25T-2R7J	T	29.1/55.5
L228	6200002861	S.COI NLV25T-4R7J	T	44.6/54.7
L229	6200004671	S.COI NLV25T-3R9J	T	35.1/51.5
L230	6200002041	S.COI NLV25T-101J	B	40.4/52.2
L231	6200002041	S.COI NLV25T-101J	B	40.4/49.4
L232	6200002041	S.COI NLV25T-101J	B	27.1/49.1
L233	6200002041	S.COI NLV25T-101J	B	26.4/46.2
L234	6200010780	S.COI C2520C-R10G-A	T	35.5/48.5
L235	6200010530	S.COI C2520C-R56G-A (0.56U)	B	32.9/49.5
L236	6200010950	S.COI C2520C-R15G-A (1.5U)	T	43.4/50.4
L237	6200010450	S.COI C2520C-R82G-A (0.82U)	B	32.9/46.3
L238	6200002041	S.COI NLV25T-101J	B	43.9/45
L239	6200002041	S.COI NLV25T-101J	B	38.8/39.5
L240	6200002041	S.COI NLV25T-101J	T	29.5/42.1
L241	6200010870	S.COI C2520C-R33G-A (0.33U)	B	35.1/41.6
L242	6200005011	S.COI NLV25T-100J	T	33.5/29.9
L243	6140004601	S.COI LR-518A	T	28.4/35.2
L244	6200010960	S.COI C2520C-R47G-A (0.47U)	B	39.7/44.1
L245	6200005011	S.COI NLV25T-100J	B	41.2/28.3
L246	6200009990	S.COI C2012C-R22G-A	B	30.7/36.4
L247	6200010320	S.COI C2012C-R15G-A	B	42.1/38.7
L248	6200005011	S.COI NLV25T-100J	B	43.8/36.3
L301	6200002041	S.COI NLV25T-101J	T	36.1/27.4
L302	6200002041	S.COI NLV25T-101J	T	52.6/31.8
L303	6200002041	S.COI NLV25T-101J	T	52.3/35.4
L304	6140004591	S.COI LR-517A	T	56.4/39
L305	6200002041	S.COI NLV25T-101J	T	52.8/29.3
L306	6200002041	S.COI NLV25T-101J	T	61.7/39.3
L307	6200002041	S.COI NLV25T-101J	T	60.9/32
L308	6200002041	S.COI NLV25T-101J	T	64.9/33.1
L309	6200009070	S.COI LQW18AN18NG00D (LQW1608A18NG00)	T	49.3/24
L310	6200010650	S.COI C2520C-R12G-A (0.12U)	T	65.7/38.2
L311	6200009220	S.COI LQW18AN15NG00D (LQW1608A15NG00)	T	53.5/23.2
L312	6200010660	S.COI C2520C-R15G-A (0.15U)	T	69.6/34.3
L313	6200011730	S.COI LQW18AN10NG00D	T	61.5/25.7
L314	6200002041	S.COI NLV25T-101J	T	72.5/37.3
L315	6200002041	S.COI NLV25T-101J	T	75.8/31.9
L402	6140004610	S.COI LR-520	T	70.8/27.9
L403	6200002041	S.COI NLV25T-101J	T	81.1/19.7
L404	6130002961	S.COI #617DB-1327=P3	T	84.4/27.9
L406	6130002961	S.COI #617DB-1327=P3	T	77.6/24.2
L421	6200004590	S.COI MLF1608D R18K-T	T	86.4/21.7
L501	6200004660	S.COI MLF1608A 1R8K-T	T	93.4/35.7
L503	6200004660	S.COI MLF1608A 1R8K-T	T	83.2/31.1
L507	6200001981	S.COI NLV25T-1R0J	T	78.7/34.4
L508	6200010650	S.COI C2520C-R12G-A (0.12U)	T	86.3/34.4
L509	6200004660	S.COI MLF1608A 1R8K-T	T	93.1/38.7
L511	6200004150	S.COI MLF1608D 47NM-T	T	92.7/37.2
L512	6200009610	S.COI MLG1608B 39NJ-T	B	89.6/32.8
L601	6200004660	S.COI MLF1608A 1R8K-T	B	85.7/38.6
L603	6200004660	S.COI MLF1608A 1R8K-T	T	89.3/42.2
L604	6150005330	S.COI LS-548 PKI-4185	T	90.5/46.2
L605	6200004660	S.COI MLF1608A 1R8K-T	T	93.1/39.9
L607	6200011800	S.COI C2520C-47NG-A	B	85.6/43.5
L609	6200011800	S.COI C2520C-47NG-A	B	81.5/46
L610	6200004660	S.COI MLF1608A 1R8K-T	B	78.1/44.8
L611	6200004660	S.COI MLF1608A 1R8K-T	T	68/46.3
L612	6150005330	S.COI LS-548 PKI-4185	T	72.2/42.4
L701	6150005350	S.COI LS-550 PKI-4187	T	62.9/48.6
L702	6150005340	S.COI LS-549 PKI-4186	T	54.8/45.4
L703	6150005350	S.COI LS-550 PKI-4187	T	55.3/59.5
L704	6200004940	S.COI MLF1608D R27K-T	T	62.3/59.6
L705	6200009920	S.COI C2012C-R10G-A	T	61.8/41.7
L801	6140002810	S.COI LR-317	T	68.6/61.3
L802	6200005190	S.COI MLF1608D R56K-T	T	89/58.4
L803	6140002810	S.COI LR-317	T	79.6/60.1
L804	6200005011	S.COI NLV25T-100J	T	57.5/69.1
L805	6200009871	S.COI NLV25T-120J	T	57.6/71.9
L806	6200004741	S.COI NLV25T-1R2J	T	63.1/71.2
L807	6200004741	S.COI NLV25T-1R2J	T	63.2/66.7
L808	6200004100	S.COI MLF1608D 68NM-T	T	86.1/61.6
L901	6200003520	S.COI ELJFB 102K-F	B	37.6/72.4
L904	6150005360	S.COI LS-551 PKI-4188-1	T	51.6/70.9
L905	6200003520	S.COI ELJFB 102K-F	B	40.2/59.9
L906	6200003520	S.COI ELJFB 102K-F	B	33.6/62.4
L908	6200003520	S.COI ELJFB 102K-F	B	31.5/69.7
L1003	6200003520	S.COI ELJFB 102K-F	B	12.9/75.3
L1102	6200002041	S.COI NLV25T-101J	T	7.1/89.7
L1301	6200002041	S.COI NLV25T-101J	T	8.3/55.8
L1302	6200002041	S.COI NLV25T-101J	T	11.8/58.5
L1303	6200002041	S.COI NLV25T-101J	T	4.8/55.8

[MAIN UNIT]

REF NO.	PARTS NO.	DESCRIPTION	M.	H/V LOCATION
L1401	6200002041	S.COI NLV25T-101J	B	43.3/79.6
L1402	6200004790	S.COI MLF1608D R47K-T	B	44.1/70.4
L1403	6200002041	S.COI NLV25T-101J	B	43/77.1
L1404	6200003711	S.COI NLV25T-2R7J	B	18.2/80.4
L1405	6200002041	S.COI NLV25T-101J	B	17.7/85
L1491	6200010870	S.COI C2520C-R33G-A (0.33U) [EUR]	B	84.9/30.7
	6200010870	S.COI C2520C-R33G-A (0.33U) [FRA]		
	6200010870	S.COI C2520C-R33G-A (0.33U) [ESP]		
	6200010740	S.COI C2520C-R27G-A [USA]		
	6200010870	S.COI C2520C-R33G-A (0.33U) [EXP]		
	6200010870	S.COI C2520C-R33G-A (0.33U) [ITR]		
	6200010870	S.COI C2520C-R33G-A (0.33U) [UK]		
	6200010740	S.COI C2520C-R27G-A [KOR]		
	6200010870	S.COI C2520C-R33G-A (0.33U) [AUS]		
	6200010870	S.COI C2520C-R33G-A (0.33U) [CHN]		
L1492	6200010870	S.COI C2520C-R33G-A (0.33U) [EUR]	B	80.6/33.1
	6200010870	S.COI C2520C-R33G-A (0.33U) [FRA]		
	6200010870	S.COI C2520C-R33G-A (0.33U) [ESP]		
	6200010740	S.COI C2520C-R27G-A [USA]		
	6200010870	S.COI C2520C-R33G-A (0.33U) [EXP]		
	6200010870	S.COI C2520C-R33G-A (0.33U) [ITR]		
	6200010870	S.COI C2520C-R33G-A (0.33U) [UK]		
	6200010740	S.COI C2520C-R27G-A [KOR]		
	6200010870	S.COI C2520C-R33G-A (0.33U) [AUS]		
	6200010870	S.COI C2520C-R33G-A (0.33U) [CHN]		
L1501	6200005011	S.COI NLV25T-100J	B	91.1/27.1
L1502	6200012170	S.COI MLG1608SR18J-T	B	79.4/38.2
L1503	6200012170	S.COI MLG1608SR18J-T	B	82/37.5
L1504	6200005011	S.COI NLV25T-100J	B	75.6/43.4
L1505	6200005190	S.COI MLF1608D R56K-T	B	73.2/48.5
L1506	6150005080	S.COI LS-535 (4KMH) [EUR]	T	68.7/55.4
	6150005080	S.COI LS-535 (4KMH) [FRA]		
	6150005080	S.COI LS-535 (4KMH) [ESP]		
	6150005070	S.COI LS-534 (4KMH) [USA]		
	6150005080	S.COI LS-535 (4KMH) [EXP]		
	6150005080	S.COI LS-535 (4KMH) [ITR]		
	6150005080	S.COI LS-535 (4KMH) [UK]		
	6150005070	S.COI LS-534 (4KMH) [KOR]		
	6150005080	S.COI LS-535 (4KMH) [AUS]		
	6150005080	S.COI LS-535 (4KMH) [CHN]		
L1507	6200005031	S.COI NLV25T-180J	B	71.7/62.2
L1508	6200005021	S.COI NLV25T-150J	B	77.3/79.5
L1951	6180003610	S.COI 7E10L-101M 100U	B	34.6/110.9
L1952	6180003610	S.COI 7E10L-101M 100U	B	54.7/113.3
L1953	6180003610	S.COI 7E10L-101M 100U	B	14/111.9
L1954	6180003610	S.COI 7E10L-101M 100U	B	24.4/119.8
L2001	6200005011	S.COI NLV25T-100J	B	72.5/16.4
L2002	6200002041	S.COI NLV25T-101J	B	84.5/3.8
L2003	6200002041	S.COI NLV25T-101J	B	81.1/4.3
L2004	6200002041	S.COI NLV25T-101J	B	76.3/20.4
L2006	6200002041	S.COI NLV25T-101J	B	64.2/12.8
L2007	6200002041	S.COI NLV25T-101J	B	70.9/3.8
L2008	6200002041	S.COI NLV25T-101J	B	67.9/6.1
L2009	6200005011	S.COI NLV25T-100J	B	70.8/10.6
L2010	6200002041	S.COI NLV25T-101J	B	60.7/13.7
L2011	6200011300	S.COI EXCML16A270U	T	86.6/9.1
L2012	6200011300	S.COI EXCML16A270U	B	84.7/21.9
L2013	6200002041	S.COI NLV25T-101J	B	71.8/19.4
L2015	6200002041	S.COI NLV25T-101J	B	52.5/10.4
L2016	6200002041	S.COI NLV25T-101J	B	59.2/11.2
L2017	6200002041	S.COI NLV25T-101J	B	57/14
L2018	6200002041	S.COI NLV25T-101J	B	19.7/129.4
L2019	6200002041	S.COI NLV25T-101J	T	22.2/126.9
L2020	6200002041	S.COI NLV25T-101J	B	27.9/131.3
L2021	6200005011	S.COI NLV25T-100J	B	27.9/126.5
L2022	6200002041	S.COI NLV25T-101J	B	22.6/127.6
L2023	6200002041	S.COI NLV25T-101J	B	23.2/131.3
L2024	6200002041	S.COI NLV25T-101J	T	12.7/128.2
L2025	6200002041	S.COI NLV25T-101J	B	87.5/6.2
L2026	6200002041	S.COI NLV25T-101J	B	77.6/5
L2027	6200002041	S.COI NLV25T-101J	B	76.5/12.2
L2028	6200002041	S.COI NLV25T-101J	B	67.4/10.8
L2029	6200002041	S.COI NLV25T-101J	B	64/10.3
L2030	6200002041	S.COI NLV25T-101J	B	67.5/3.6
L2031	6200002041	S.COI NLV25T-101J	B	76.5/14.7
L2032	6200002041	S.COI NLV25T-101J	B	66.1/15.3
L2033	6200011300	S.COI EXCML16A270U	B	69.6/14.5
L2034	6200009300	S.COI ELJPA 100KF 10U	B	67.8/19.3
L2035	6200002041	S.COI NLV25T-101J	B	59.8/18.4
L2036	6200002041	S.COI NLV25T-101J	B	64.1/3.8
L2037	6200002041	S.COI NLV25T-101J	B	88.3/3.7
L2041	6180003610	S.COI 7E10L-101M 100U	B	62.6/86.9
L2042	6200002861	S.COI NLV25T-4R7J	B	62.9/79.3
L2053	6200002041	S.COI NLV25T-101J	B	28.7/90.9
L2151	6200002041	S.COI NLV25T-101J	B	36.9/121
L2152	6200002041	S.COI NLV25T-101J	B	52.3/14.7
L2201	6200005011	S.COI NLV25T-100J	T	27.3/125.8
L2202	6200005011	S.COI NLV25T-100J	T	17/124.3
L2231	6200002041	S.COI NLV25T-101J	T	34/104.2
L2256	6200002041	S.COI NLV25T-101J	T	15/103.4
L2257	6200002041	S.COI NLV25T-101J	T	10.5/89.7
L2260	6200002041	S.COI NLV25T-101J	T	68.5/110.9
L2263	6200002041	S.COI NLV25T-101J	T	62.3/99.4
L2264	6200002041	S.COI NL		

[MAIN UNIT]

REF NO.	PARTS NO.	DESCRIPTION	M.	H/V LOCATION
L2268	6200002041	S.COI NLV25T-101J	T	62.4/87.1
L2272	6200002041	S.COI NLV25T-101J	T	71.1/90.2
L2402	6200002041	S.COI NLV25T-101J	B	89.4/98
L2403	6200002041	S.COI NLV25T-101J	B	89.2/84
L2404	6200002041	S.COI NLV25T-101J	T	81.6/96.8
L2405	6200002041	S.COI NLV25T-101J	B	89.3/95.5
L2406	6200002041	S.COI NLV25T-101J	T	84.8/93.7
L2408	6200011300	S.COI EXCML16A270U	T	82.1/92.3
L2409	6200002041	S.COI NLV25T-101J	B	89.3/88.5
L2411	6200011300	S.COI EXCML16A270U	T	85.1/89.7
L2601	6200009330	S.COI SLF12555T-681MR43-PF	T	87.5/119.6
L2605	6200009330	S.COI SLF12555T-681MR43-PF	T	71/119.6
R1	7030011400	S.RES ERJ2GEJ 5R6 X (5.6)	T	79.7/17
R2	7030009270	S.RES ERJ2GEJ 821 X (820)	T	81.3/17
R3	7030009270	S.RES ERJ2GEJ 821 X (820)	T	79.7/17.9
R5	7030010090	S.RES ERJ2GEJ 180 X (18)	T	74.2/16.7
R6	7030008280	S.RES ERJ2GEJ 271 X (270)	T	74.8/15.8
R7	7030008280	S.RES ERJ2GEJ 271 X (270)	T	73.2/15.8
R8	7030009200	S.RES ERJ2GEJ 390 X (39)	T	73/18.5
R9	7030003400	S.RES ERJ3GEYJ 471 V (470)	T	69.9/13.3
R10	7030005120	S.RES ERJ2GEJ 102 X (1K)	T	72.8/14.9
R11	7030005300	S.RES ERJ2GEJ 150 X (15)	T	62.1/15.9
R12	7030010040	S.RES ERJ2GEJ-JPW	T	62.9/13.8
R13	7030005090	S.RES ERJ2GEJ 104 X (100K)	T	66.8/20.6
R15	7030005090	S.RES ERJ2GEJ 104 X (100K)	T	70.4/10.4
R16	7030003860	S.RES ERJ3GE JPW V	T	62.4/12.3
R17	7030005090	S.RES ERJ2GEJ 104 X (100K)	T	76.4/15.8
R18	7030007270	S.RES ERJ2GEJ 151 X (150)	T	44.2/17.2
R19	7030003860	S.RES ERJ3GE JPW V	T	50.4/14.6
R20	7030009530	S.RES ERJ2GEJ 270 X (27)	T	69.5/19.7
R21	7030009530	S.RES ERJ2GEJ 270 X (27)	T	65.4/22.8
R22	7030010040	S.RES ERJ2GEJ-JPW	T	78.1/13.8
R23	7030007290	S.RES ERJ2GEJ 222 X (2.2K)	T	79.8/13.8
R24	7030005010	S.RES ERJ2GEJ 681 X (680)	T	78.1/12.9
R25	7030005120	S.RES ERJ2GEJ 102 X (1K)	B	79.2/18.5
R27	7030005120	S.RES ERJ2GEJ 102 X (1K)	B	81.3/8.5
R29	7030004980	S.RES ERJ2GEJ 101 X (100)	T	73.1/11.3
R30	7030009160	S.RES ERJ2GEJ 181 X (180)	T	46.4/15.4
R31	7030007270	S.RES ERJ2GEJ 151 X (150)	T	42.6/17.2
R32	7030009200	S.RES ERJ2GEJ 390 X (39)	T	44.1/18.2
R35	7030003860	S.RES ERJ3GE JPW V [EUR]	T	59.9/17.8
	7030003860	S.RES ERJ3GE JPW V [FRA]		
	7030003860	S.RES ERJ3GE JPW V [ESP]		
	7030003860	S.RES ERJ3GE JPW V [USA]		
	7030003860	S.RES ERJ3GE JPW V [EXPT]		
	7030003860	S.RES ERJ3GE JPW V [ITR]		
	7030003860	S.RES ERJ3GE JPW V [UK]		
	7030003860	S.RES ERJ3GE JPW V [KOR]		
	7030003860	S.RES ERJ3GE JPW V [CHN]		
R101	7030005050	S.RES ERJ2GEJ 103 X (10K)	T	13.2/16
R102	7030005120	S.RES ERJ2GEJ 102 X (1K)	T	11.9/14.6
R103	7030005050	S.RES ERJ2GEJ 103 X (10K)	T	10.3/14.6
R104	7030005090	S.RES ERJ2GEJ 104 X (100K)	T	15.7/13.4
R105	7030005580	S.RES ERJ2GEJ 560 X (56)	T	15.7/22.3
R106	7030005000	S.RES ERJ2GEJ 471 X (470)	T	13.2/20.5
R107	7030005000	S.RES ERJ2GEJ 471 X (470)	T	10.8/22.1
R108	7030005000	S.RES ERJ2GEJ 471 X (470)	T	10.8/23
R111	7030005000	S.RES ERJ2GEJ 471 X (470)	T	10.8/21.2
R112	7030005090	S.RES ERJ2GEJ 104 X (100K)	T	25.6/12.5
R113	7030005090	S.RES ERJ2GEJ 104 X (100K)	T	26.8/5.7
R114	7030009280	S.RES ERJ2GEJ 391 X	B	33.1/23.4
R115	7030009280	S.RES ERJ2GEJ 391 X	B	34.1/22.2
R116	7030009280	S.RES ERJ2GEJ 391 X	T	22.3/21.3
R117	7030009280	S.RES ERJ2GEJ 391 X	T	20.7/21.3
R118	7030009280	S.RES ERJ2GEJ 391 X	B	40.9/23.2
R119	7030009280	S.RES ERJ2GEJ 391 X	B	40.9/22.3
R120	7030005090	S.RES ERJ2GEJ 104 X (100K)	B	50.3/23.5
R121	7030005090	S.RES ERJ2GEJ 104 X (100K)	T	44/22.4
R122	7030009280	S.RES ERJ2GEJ 391 X	T	7.8/20.3
R123	7030009280	S.RES ERJ2GEJ 391 X	T	7.8/19.4
R125	7030009280	S.RES ERJ2GEJ 391 X	T	35.5/20.2
R126	7030009280	S.RES ERJ2GEJ 391 X	T	27/4.8
R127	7030009280	S.RES ERJ2GEJ 391 X	T	25.4/4.8
R128	7030009280	S.RES ERJ2GEJ 391 X	T	35.5/19.3
R202	7030005090	S.RES ERJ2GEJ 104 X (100K)	T	18.1/31.2
R203	7030005090	S.RES ERJ2GEJ 104 X (100K)	T	42.9/59.9
R204	7030005090	S.RES ERJ2GEJ 104 X (100K)	B	42.9/54.3
R205	7030009280	S.RES ERJ2GEJ 391 X	T	19.4/54.2
R206	7030005090	S.RES ERJ2GEJ 104 X (100K)	B	42.9/51.4
R207	7030005090	S.RES ERJ2GEJ 104 X (100K)	B	42.9/50.5
R208	7030005090	S.RES ERJ2GEJ 104 X (100K)	B	46.4/4.5
R216	7030005090	S.RES ERJ2GEJ 104 X (100K)	B	44.2/43.3
R217	7030005050	S.RES ERJ2GEJ 103 X (10K)	T	18.1/30.3
R218	7030004970	S.RES ERJ2GEJ 470 X (47)	T	21.9/29.9
R225	7030005050	S.RES ERJ2GEJ 103 X (10K)	T	19.1/29.1
R226	7030009280	S.RES ERJ2GEJ 391 X	T	17.6/54.2
R227	7030005120	S.RES ERJ2GEJ 102 X (1K)	T	30.9/30.9
R228	7030009140	S.RES ERJ2GEJ 272 X (2.7K)	T	30.9/29.1
R301	7030009280	S.RES ERJ2GEJ 391 X	T	44.5/28.8
R302	7030009280	S.RES ERJ2GEJ 391 X	T	38.6/27.8
R303	7030004970	S.RES ERJ2GEJ 470 X (47)	T	52.5/38.9
R304	7030004980	S.RES ERJ2GEJ 101 X (100)	T	55.1/35.6
R305	7030005120	S.RES ERJ2GEJ 102 X (1K)	T	59.9/33.8
R306	7030008280	S.RES ERJ2GEJ 271 X (270)	T	55.3/28.7
R307	7030004980	S.RES ERJ2GEJ 101 X (100)	T	56.7/35.6

[MAIN UNIT]

REF NO.	PARTS NO.	DESCRIPTION	M.	H/V LOCATION
R308	7030007290	S.RES ERJ2GEJ 222 X (2.2K)	T	59.2/30.1
R309	7030008280	S.RES ERJ2GEJ 271 X (270)	T	58.5/29.1
R310	7030005090	S.RES ERJ2GEJ 104 X (100K)	T	50.1/31.7
R311	7030009280	S.RES ERJ2GEJ 391 X	T	65.3/31.3
R312	7030009280	S.RES ERJ2GEJ 391 X	T	63.7/31.3
R314	7030009280	S.RES ERJ2GEJ 391 X	T	73.3/32.5
R315	7030009280	S.RES ERJ2GEJ 391 X	T	74.8/33.8
R401	7030010040	S.RES ERJ2GEJ-JPW	T	75/29.5
R402	7030010040	S.RES ERJ2GEJ-JPW	T	75/27.7
R403	7030004980	S.RES ERJ2GEJ 101 X (100)	T	76.7/29.6
R404	7030010040	S.RES ERJ2GEJ-JPW	T	71.9/23.1
R405	7030004980	S.RES ERJ2GEJ 101 X (100)	T	86.8/23.8
R406	7030005580	S.RES ERJ2GEJ 560 X (56)	T	73.1/30.6
R407	7030005580	S.RES ERJ2GEJ 560 X (56)	T	71.9/24.9
R408	7030010040	S.RES ERJ2GEJ-JPW	T	83.3/19.2
R411	7030007260	S.RES ERJ2GEJ 330 X (33)	T	80/29.5
R412	7030007260	S.RES ERJ2GEJ 330 X (33)	T	80/26.8
R414	7030004980	S.RES ERJ2GEJ 101 X (100)	T	78.3/29.6
R416	7030010090	S.RES ERJ2GEJ 180 X (18)	T	88.3/24.4
R417	7030008280	S.RES ERJ2GEJ 271 X (270)	T	89.2/25.3
R418	7030008280	S.RES ERJ2GEJ 271 X (270)	T	88/22.8
R421	7030010090	S.RES ERJ2GEJ 180 X (18)	B	88.5/20.9
R422	7030008280	S.RES ERJ2GEJ 271 X (270)	B	90.1/20.2
R423	7030008280	S.RES ERJ2GEJ 271 X (270)	B	90.1/19.3
R424	7030005530	S.RES ERJ2GEJ 100 X (10)	T	88.5/21.6
R501	7030005120	S.RES ERJ2GEJ 102 X (1K)	T	91.3/35.6
R502	7030005120	S.RES ERJ2GEJ 102 X (1K)	T	92.9/34.4
R509	7030005580	S.RES ERJ2GEJ 560 X (56)	T	83.4/33.1
R510	7030010040	S.RES ERJ2GEJ-JPW	T	83.4/34.1
R512	7030004980	S.RES ERJ2GEJ 101 X (100)	T	81.7/34.1
R517	7030010040	S.RES ERJ2GEJ-JPW	B	80/31
R518	7030007290	S.RES ERJ2GEJ 222 X (2.2K)	T	79.5/37
R519	7030007290	S.RES ERJ2GEJ 222 X (2.2K)	T	79.5/38.8
R520	7030005120	S.RES ERJ2GEJ 102 X (1K)	T	89.1/39.2
R521	7030005000	S.RES ERJ2GEJ 471 X (470)	T	84.2/40.4
R523	7030005120	S.RES ERJ2GEJ 102 X (1K)	T	91.3/34.7
R524	7030005120	S.RES ERJ2GEJ 102 X (1K)	B	86.9/37
R601	7030005000	S.RES ERJ2GEJ 471 X (470)	B	88.5/40
R602	7030005000	S.RES ERJ2GEJ 471 X (470)	T	91/39.6
R603	7030005000	S.RES ERJ2GEJ 471 X (470)	T	89.1/41
R604	7030005000	S.RES ERJ2GEJ 471 X (470)	B	78.6/45.9
R605	7030010040	S.RES ERJ2GEJ-JPW	T	68.2/45.2
R606	7030005090	S.RES ERJ2GEJ 104 X (100K)	T	67.1/47.4
R607	7030005120	S.RES ERJ2GEJ 102 X (1K)	T	66.6/45.2
R701	7030005220	S.RES ERJ2GEJ 223 X (22K)	T	61.1/53
R702	7030005120	S.RES ERJ2GEJ 102 X (1K)	T	64.2/43.9
R703	7030004970	S.RES ERJ2GEJ 470 X (47)	T	50.8/44.1
R705	7030004990	S.RES ERJ2GEJ 221 X (220)	T	59/51.5
R706	7030009270	S.RES ERJ2GEJ 821 X (820)	T	64.5/55.9
R707	7030004980	S.RES ERJ2GEJ 101 X (100)	T	59.5/57
R708	7030007290	S.RES ERJ2GEJ 222 X (2.2K)	T	63.9/58.6
R709	7030005210	S.RES ERJ2GEJ 822 X (8.2K)	T	59.5/55.1
R710	7030005120	S.RES ERJ2GEJ 102 X (1K)	T	59.8/62.5
R711	7030009140	S.RES ERJ2GEJ 272 X (2.7K)	T	50.5/51.4
R712	7030005120	S.RES ERJ2GEJ 102 X (1K)	T	51.2/50.5
R713	7030005050	S.RES ERJ2GEJ 103 X (10K)	T	57.1/51.5
R715	7030004970	S.RES ERJ2GEJ 470 X (47)	T	52.1/54.1
R716	7030005710	S.RES ERJ2GEJ 121 X (120)	T	51.3/57.5
R717	7030007300	S.RES ERJ2GEJ 332 X (3.3K)	T	52.1/51.4
R718	7510001461	S.THE NTCG16 3NH 471JT	T	63.3/54
R801	7030008280	S.RES ERJ2GEJ 271 X (270)	T	86.8/55.2
R802	7030005120	S.RES ERJ2GEJ 102 X (1K)	T	65.3/60.9
R803	7030005120	S.RES ERJ2GEJ 102 X (1K)	T	71.9/64.9
R804	7030005530	S.RES ERJ2GEJ 100 X (10)	T	91.1/57.1
R805	7030010090	S.RES ERJ2GEJ 180 X (18)	T	84.7/54.3
R806	7030008280	S.RES ERJ2GEJ 271 X (270)	T	85.2/55.2
R807	7030005120	S.RES ERJ2GEJ 102 X (1K)	T	62.8/64.6
R808	7030004970	S.RES ERJ2GEJ 470 X (47)	T	62.3/69.4
R809	7030008280	S.RES ERJ2GEJ 271 X (270)	T	82.8/60.6
R810	7030010090	S.RES ERJ2GEJ 180 X (18)	T	84.4/60.6
R811	7030008280	S.RES ERJ2GEJ 271 X (270)	T	82.8/59.7
R904	7030003860	S.RES ERJ3GE JPW V	T	36.5/68.1
R905	7030004980	S.RES ERJ2GEJ 101 X (100)	T	39.2/64.6
R906	7030007290	S.RES ERJ2GEJ 222 X (2.2K)	T	39.2/66.5
R908	7030005000	S.RES ERJ2GEJ 471 X (470)	T	35.6/61.9
R909	7030008410	S.RES ERJ2GEJ 392 X (3.9K)	T	34.2/68.4
R912	7030005210	S.RES ERJ2GEJ 822 X (8.2K)	T	34.2/66.6
R913	7030007300	S.RES ERJ2GEJ 332 X (3.3K)	T	40.5/75
R914	7030009290	S.RES ERJ2GEJ 562 X (5.6K)	T	35.6/75.4
R915	7030007290	S.RES ERJ2GEJ 222 X (2.2K)	T	36.6/70.9
R916	7030005050	S.RES ERJ2GEJ 103 X (10K)	T	37.2/75.4
R917	7030004970	S.RES ERJ2GEJ 470 X (47)	T	34.2/69.3
R918	7030007290	S.RES ERJ2GEJ 222 X (2.2K)	B	31.4/72.1
R919	7030004980	S.RES ERJ2GEJ 101 X (100)	T	31.5/72.1
R1009	7030009290	S.RES ERJ2GEJ 562 X (5.6K)	T	25.8/72.9
R1018	7030007290	S.RES ERJ2GEJ 222 X (2.2K)	T	20.3/75
R1019	7030005050	S.RES ERJ2GEJ 103 X (10K)	T	20.3/76.9
R1020	7030005000	S.RES ERJ2GEJ 471 X (470)	T	12.7/77.9
R1022	7510001461	S.THE NTCG16 3NH 471JT	T	14.8/76.8
R1023	7030008370	S.RES ERJ2GEJ 561 X (560)	T	15.2/77.8
R1024	7030004980	S.RES ERJ2GEJ 101 X (100)	T	12.7/74.9
R1025	7030007260	S.RES ERJ2GEJ 330 X (33)		

[MAIN UNIT]

REF NO.	PARTS NO.	DESCRIPTION	M.	H/V LOCATION
R1205	7030005000	S.RES ERJ2GEJ 471 X (470)	T	20.2/78.3
R1206	7030005090	S.RES ERJ2GEJ 104 X (100K)	T	21.8/79.2
R1207	7030005240	S.RES ERJ2GEJ 473 X (47K)	T	17.9/83.6
R1208	7030004980	S.RES ERJ2GEJ 101 X (100)	T	9.4/79.8
R1209	7030004980	S.RES ERJ2GEJ 101 X (100)	T	16.4/79.9
R1211	7030005120	S.RES ERJ2GEJ 102 X (1K)	T	12.7/79.4
R1212	7030005120	S.RES ERJ2GEJ 102 X (1K)	T	11.1/78.5
R1213	7030005120	S.RES ERJ2GEJ 102 X (1K)	T	11.1/79.4
R1215	7030007350	S.RES ERJ2GEJ 393 X (39K)	T	8.1/81.3
R1216	7030007290	S.RES ERJ2GEJ 222 X (2.2K)	T	9.5/83.2
R1217	7030007290	S.RES ERJ2GEJ 222 X (2.2K)	T	8/82.8
R1218	7030005050	S.RES ERJ2GEJ 103 X (10K)	T	7.5/78.5
R1219	7030005050	S.RES ERJ2GEJ 103 X (10K)	T	7.5/79.7
R1301	7030010040	S.RES ERJ2GEJ-JPW	T	15.2/74.8
R1302	7030005120	S.RES ERJ2GEJ 102 X (1K)	T	15.2/72.7
R1303	7030005120	S.RES ERJ2GEJ 102 X (1K)	T	12.7/74
R1304	7030005120	S.RES ERJ2GEJ 102 X (1K)	T	14.9/68.3
R1305	7030005120	S.RES ERJ2GEJ 102 X (1K)	T	16.2/63.8
R1306	7030005120	S.RES ERJ2GEJ 102 X (1K)	T	10.9/56.8
R1308	7030007300	S.RES ERJ2GEJ 332 X (3.3K)	T	12.9/67.3
R1309	7030005120	S.RES ERJ2GEJ 102 X (1K)	T	11.3/66.4
R1310	7510001451	S.THE NTCG16 4BH 472JT	T	12.2/68.4
R1401	7030005120	S.RES ERJ2GEJ 102 X (1K)	B	45.3/72.3
R1402	7030008010	S.RES ERJ2GEJ 123 X (12K)	B	43.6/72.3
R1403	7030007290	S.RES ERJ2GEJ 222 X (2.2K)	B	44.5/73.4
R1404	7030007280	S.RES ERJ2GEJ 331 X (330)	B	44.5/75.2
R1405	7030004970	S.RES ERJ2GEJ 470 X (47)	B	42/71.5
R1406	7030005290	S.RES ERJ2GEJ 682 X (6.8K)	B	38.7/79.9
R1407	7030005120	S.RES ERJ2GEJ 102 X (1K)	B	38.7/77.9
R1408	7030007280	S.RES ERJ2GEJ 331 X (330)	B	38.7/80.8
R1409	7030004970	S.RES ERJ2GEJ 470 X (47)	B	34.6/80
R1414	7030007340	S.RES ERJ2GEJ 153 X (15K)	B	20.2/76.4
R1416	7030008410	S.RES ERJ2GEJ 392 X (3.9K)	B	19.4/83
R1420	7030004990	S.RES ERJ2GEJ 221 X (220)	B	25/76.8
R1421	7030007270	S.RES ERJ2GEJ 151 X (150)	B	23.2/75.9
R1422	7030004990	S.RES ERJ2GEJ 221 X (220)	B	23.2/76.8
R1501	7030010040	S.RES ERJ2GEJ-JPW	B	72.4/38.2
R1502	7030005100	S.RES ERJ2GEJ 154 X (150K)	B	86.4/55.3
R1503	7030005100	S.RES ERJ2GEJ 154 X (150K)	B	85.7/54.1
R1504	7030004970	S.RES ERJ2GEJ 470 X (47)	B	72.4/40.3
R1505	7030007290	S.RES ERJ2GEJ 222 X (2.2K)	B	71.8/53.9
R1506	7030007350	S.RES ERJ2GEJ 393 X (39K)	B	85.7/52.3
R1507	7030007350	S.RES ERJ2GEJ 393 X (39K)	B	85.7/53.2
R1508	7030005220	S.RES ERJ2GEJ 223 X (22K)	B	74.2/61.6
R1509	7030006610	S.RES ERJ2GEJ 394 X (390K)	B	85.9/59
R1510	7030005050	S.RES ERJ2GEJ 103 X (10K)	B	76.6/61.9
	7030005050	S.RES ERJ2GEJ 103 X (10K)	[USA] [KOR]	
R1511	7030005590	S.RES ERJ2GEJ 680 X (68)	B	85.8/60.8
R1512	7030005120	S.RES ERJ2GEJ 102 X (1K)	B	71.5/73.7
R1513	7030007280	S.RES ERJ2GEJ 331 X (330)	B	73.1/73.7
R1514	7030007290	S.RES ERJ2GEJ 222 X (2.2K)	B	73.4/53
R1515	7030007290	S.RES ERJ2GEJ 222 X (2.2K)	B	71.8/53
R1516	7030004970	S.RES ERJ2GEJ 470 X (47)	B	82.5/35.3
R1521	7030005090	S.RES ERJ2GEJ 104 X (100K)	B	86.5/50.3
R1522	7030005240	S.RES ERJ2GEJ 473 X (47K)	B	86.7/46.8
R1523	7030005120	S.RES ERJ2GEJ 102 X (1K)	B	77.3/39.5
R1524	7030005120	S.RES ERJ2GEJ 102 X (1K)	B	81.9/40.2
R1525	7030007300	S.RES ERJ2GEJ 332 X (3.3K)	B	81.9/42.2
R1526	7030005120	S.RES ERJ2GEJ 102 X (1K)	B	83.5/40.5
R1602	7030005120	S.RES ERJ2GEJ 102 X (1K)	T	6.3/54
R1603	7030010040	S.RES ERJ2GEJ-JPW	T	13/49.6
R1604	7030007290	S.RES ERJ2GEJ 222 X (2.2K)	T	13/50.5
R1605	7030005090	S.RES ERJ2GEJ 104 X (100K)	T	8.8/46.9
R1606	7030005070	S.RES ERJ2GEJ 683 X (68K)	T	6.1/46.6
R1607	7030005070	S.RES ERJ2GEJ 683 X (68K)	T	5.1/42.1
R1608	7030005090	S.RES ERJ2GEJ 104 X (100K)	T	10.4/47.8
R1609	7030007320	S.RES ERJ2GEJ 225 X (2.2M)	T	10.4/46
R1610	7030005060	S.RES ERJ2GEJ 333 X (33K)	T	4.5/43.5
R1611	7030005230	S.RES ERJ2GEJ 334 X (330K)	T	8.8/47.8
R1612	7030005060	S.RES ERJ2GEJ 333 X (33K)	T	3.4/42.3
R1613	7030003860	S.RES ERJ3GE JPW V	T	6.7/48.7
R1614	7030007310	S.RES ERJ2GEJ 155 X (1.5M)	T	6.1/45.7
R1615	7030005040	S.RES ERJ2GEJ 472 X (4.7K)	T	4.2/35.4
R1616	7030005090	S.RES ERJ2GEJ 104 X (100K)	T	6.7/35.4
R1617	7030005720	S.RES ERJ2GEJ 563 X (56K)	T	3.4/38.2
R1618	7310005020	S.TRI RH03ADC14X (10K)	T	3.5/46.3
R1619	7030005080	S.RES ERJ2GEJ 823 X (82K)	[USA] [FRA] [ESP] [USA] [EXP] [ITR] [UK] [KOR] [AUS] [CHN]	T 2.6/43.3
	7030005080	S.RES ERJ2GEJ 823 X (82K)	[USA] [EXP] [ITR] [UK] [KOR] [AUS] [CHN]	
	7030005080	S.RES ERJ2GEJ 823 X (82K)	[USA] [EXP] [ITR] [UK] [KOR] [AUS] [CHN]	
	7030005080	S.RES ERJ2GEJ 823 X (82K)	[USA] [EXP] [ITR] [UK] [KOR] [AUS] [CHN]	
	7030005080	S.RES ERJ2GEJ 823 X (82K)	[USA] [EXP] [ITR] [UK] [KOR] [AUS] [CHN]	
	7030005080	S.RES ERJ2GEJ 823 X (82K)	[USA] [EXP] [ITR] [UK] [KOR] [AUS] [CHN]	
	7030005080	S.RES ERJ2GEJ 823 X (82K)	[USA] [EXP] [ITR] [UK] [KOR] [AUS] [CHN]	
	7030005080	S.RES ERJ2GEJ 823 X (82K)	[USA] [EXP] [ITR] [UK] [KOR] [AUS] [CHN]	
	7030005080	S.RES ERJ2GEJ 823 X (82K)	[USA] [EXP] [ITR] [UK] [KOR] [AUS] [CHN]	
	7030005080	S.RES ERJ2GEJ 823 X (82K)	[USA] [EXP] [ITR] [UK] [KOR] [AUS] [CHN]	
R1620	7030008290	S.RES ERJ2GEJ 183 X (18K)	T	3.4/37.3
R1621	7030005160	S.RES ERJ2GEJ 105 X (1M)	T	6.7/37.2
R1622	7030010040	S.RES ERJ2GEJ-JPW	T	5/37.3
R1623	7030005000	S.RES ERJ2GEJ 471 X (470)	T	12/46.8
R1624	7030007250	S.RES ERJ2GEJ 220 X (22)	T	14.9/38.3
R1625	7030004990	S.RES ERJ2GEJ 221 X (220)	T	13.6/32.6
R1626	7030005050	S.RES ERJ2GEJ 103 X (10K)	T	10.3/34.5
R1627	7030007320	S.RES ERJ2GEJ 225 X (2.2M)	T	10.3/35.4
R1628	7030005120	S.RES ERJ2GEJ 102 X (1K)	T	4.9/30.8
R1629	7030005050	S.RES ERJ2GEJ 103 X (10K)	T	4.9/29.9
R1630	7030004980	S.RES ERJ2GEJ 101 X (100)	T	8.3/45.7

[MAIN UNIT]

REF NO.	PARTS NO.	DESCRIPTION	M.	H/V LOCATION
R1631	7030005090	S.RES ERJ2GEJ 104 X (100K)	T	9.8/37.2
R1634	7030005040	S.RES ERJ2GEJ 472 X (4.7K)	T	10.3/33.6
R1636	7030007320	S.RES ERJ2GEJ 225 X (2.2M)	T	13/31.7
R1637	7030007320	S.RES ERJ2GEJ 225 X (2.2M)	T	12/45.9
R1638	7030008280	S.RES ERJ2GEJ 271 X (270)	T	10.9/48.8
R1639	7030005120	S.RES ERJ2GEJ 102 X (1K)	T	14.6/50.5
R1640	7030005090	S.RES ERJ2GEJ 104 X (100K)	T	10.9/31.6
R1641	7030007320	S.RES ERJ2GEJ 225 X (2.2M)	T	13/30.7
R1642	7030005120	S.RES ERJ2GEJ 102 X (1K)	T	22.9/55.1
R1701	7030009320	S.RES ERJ2GEJ 4R7 X (4.7)	T	48/45.3
R1702	7030007280	S.RES ERJ2GEJ 331 X (330)	B	52.1/44.7
R1703	7030007280	S.RES ERJ2GEJ 331 X (330)	B	53.7/43.8
R1704	7030007280	S.RES ERJ2GEJ 331 X (330)	B	53.7/44.7
R1705	7030009320	S.RES ERJ2GEJ 4R7 X (4.7)	T	48/46.2
R1706	7030007280	S.RES ERJ2GEJ 331 X (330)	B	53.6/64.2
R1707	7030007280	S.RES ERJ2GEJ 331 X (330)	B	55.6/64.8
R1708	7030007280	S.RES ERJ2GEJ 331 X (330)	B	55.6/65.7
R1901	7030005090	S.RES ERJ2GEJ 104 X (100K)	B	20/13.9
R1902	7030011290	S.RES ERJ12YJ1R8U (1.8)	B	12.4/45.8
R1952	7030009980	S.RES ERJ12RSJR15U	B	42.6/102.3
R1953	7030009980	S.RES ERJ12RSJR15U	B	42.6/98.6
R1954	7030005170	S.RES ERJ2GEJ 474 X (470K)	B	42.7/111.3
R1955	7030005511	S.RES ERA3YED 303V (30K)	B	44.8/107.3
R1956	7030005110	S.RES ERJ2GEJ 224 X (220K)	B	33.7/105.1
R1957	7030007350	S.RES ERJ2GEJ 393 X (39K)	B	35.3/104.2
R1958	7030005720	S.RES ERJ2GEJ 563 X (56K)	B	35.3/103.3
R1981	7030008240	S.RES ERJ12Y0R00U	B	83.1/109
R2002	7030010040	S.RES ERJ2GEJ-JPW	B	36.9/12.7
R2003	7030008240	S.RES ERJ12Y0R00U	T	55.7/79
R2004	7030004990	S.RES ERJ2GEJ 221 X (220)	B	59.8/9.2
R2005	7030004990	S.RES ERJ2GEJ 221 X (220)	B	59.1/3
R2006	7030004990	S.RES ERJ2GEJ 221 X (220)	B	60.7/3.7
R2007	7030004990	S.RES ERJ2GEJ 221 X (220)	B	60.7/4.6
R2008	7030010040	S.RES ERJ2GEJ-JPW	B	34/17.6
R2010	7030010040	S.RES ERJ2GEJ-JPW	B	32.5/15.1
R2011	7030006210	S.RES ERJ12YJ4R7U (4.7)	B	13.1/26.3
R2012	7030005120	S.RES ERJ2GEJ 102 X (1K)	B	32.4/17.3
R2101	7030005090	S.RES ERJ2GEJ 104 X (100K)	T	26/113.8
R2102	7030005090	S.RES ERJ2GEJ 104 X (100K)	T	33.1/114.3
R2103	7030005090	S.RES ERJ2GEJ 104 X (100K)	T	30.7/123.2
R2104	7030005090	S.RES ERJ2GEJ 104 X (100K)	T	28.1/123.2
R2105	7030005090	S.RES ERJ2GEJ 104 X (100K)	T	32.3/118.7
R2106	7030005720	S.RES ERJ2GEJ 563 X (56K)	T	25/115.5
R2107	7030005720	S.RES ERJ2GEJ 563 X (56K)	T	31.5/114.6
R2108	7030005100	S.RES ERJ2GEJ 154 X (150K)	T	30.7/122.3
R2109	7030007350	S.RES ERJ2GEJ 393 X (39K)	T	27.1/122.3
R2110	7030005090	S.RES ERJ2GEJ 104 X (100K)	T	44.3/111.8
R2111	7030005090	S.RES ERJ2GEJ 104 X (100K)	T	44.7/110
R2112	7030005090	S.RES ERJ2GEJ 104 X (100K)	T	54.1/110.8
R2113	7030005090	S.RES ERJ2GEJ 104 X (100K)	T	54.1/111.7
R2114	7030005100	S.RES ERJ2GEJ 154 X (150K)	T	44.7/112.7
R2115	7030005100	S.RES ERJ2GEJ 154 X (150K)	T	44.7/109.1
R2116	7030005100	S.RES ERJ2GEJ 154 X (150K)	T	54.4/109.9
R2117	7030005100	S.RES ERJ2GEJ 154 X (150K)	T	54.1/112.6
R2118	7030005090	S.RES ERJ2GEJ 104 X (100K)	T	54.1/120.6
R2119	7030005090	S.RES ERJ2GEJ 104 X (100K)	T	54.1/121.8
R2120	7030008300	S.RES ERJ2GEJ 184 X (180K)	T	44.8/122.1
R2121	7030008300	S.RES ERJ2GEJ 184 X (180K)	T	42.9/121.3
R2122	7030005100	S.RES ERJ2GEJ 154 X (150K)	T	54.1/119.7
R2123	7030006610	S.RES ERJ2GEJ 394 X (390K)	T	54.2/122.8
R2124	7030005110	S.RES ERJ2GEJ 224 X (220K)	T	44.8/123
R2125	7030005110	S.RES ERJ2GEJ 224 X (220K)	T	44.8/119.4
R2126	7030010040	S.RES ERJ2GEJ-JPW	T	33.1/116.4
R2128	7030005000	S.RES ERJ2GEJ 471 X (470)	T	32.3/123.2
R2129	7030005000	S.RES ERJ2GEJ 471 X (470)	T	54.1/118.8
R2131	7030005090	S.RES ERJ2GEJ 104 X (100K)	B	39.8/122
R2132	7030005090	S.RES ERJ2GEJ 104 X (100K)	T	42.8/115.1
R2133	7030005090	S.RES ERJ2GEJ 104 X (100K)	T	40.6/114.1
R2134	7030005090	S.RES ERJ2GEJ 104 X (100K)	T	36.5/114.1
R2135	7030005090	S.RES ERJ2GEJ 104 X (100K)	T	34.9/114.2
R2136	7030005000	S.RES ERJ2GEJ 471 X (470)	T	26.5/123.2
R2137	7030005230	S.RES ERJ2GEJ 334 X (330K)	T	43.3/123.7
R2138	7030005230	S.RES ERJ2GEJ 334 X (330K)	T	42.9/122.2
R2139	7030004980	S.RES ERJ2GEJ 101 X (100)	T	25/116.4
R2140	7030004980	S.RES ERJ2GEJ 101 X (100)	T	32/115.5
R2141	7030010040	S.RES ERJ2GEJ-JPW	T	44.7/113.6
R2142	7030010040	S.RES ERJ2GEJ-JPW	T	52.7/108.9
R2143	7030010040	S.RES ERJ2GEJ-JPW	T	56.4/109
R2144	7030010040	S.RES ERJ2GEJ-JPW	T	51.3/115.1
R214				

[MAIN UNIT]

REF NO.	PARTS NO.	DESCRIPTION	M.	H/V LOCATION
R2166	7030005530	S.RES ERJ2GEJ 100 X (10)	T	51.8/93.3
R2167	7030005530	S.RES ERJ2GEJ 100 X (10)	T	51.8/94.2
R2168	7030005530	S.RES ERJ2GEJ 100 X (10)	T	51.8/95.1
R2169	7030005120	S.RES ERJ2GEJ 102 X (1K)	T	8.8/118.5
R2170	7030005170	S.RES ERJ2GEJ 474 X (470K)	T	5/104.5
R2171	7030005240	S.RES ERJ2GEJ 473 X (47K)	T	9.7/114.2
R2172	7030005240	S.RES ERJ2GEJ 473 X (47K)	T	5/112.4
R2174	7030005170	S.RES ERJ2GEJ 474 X (470K)	T	5/105.4
R2175	7030005170	S.RES ERJ2GEJ 474 X (470K)	T	5/111.5
R2176	7030005170	S.RES ERJ2GEJ 474 X (470K)	T	11.3/114.2
R2177	7030005210	S.RES ERJ2GEJ 822 X (8.2K)	T	3.3/108
R2202	7030010040	S.RES ERJ2GEJ-JPW	T	26.5/124.1
R2203	7030005080	S.RES ERJ2GEJ 823 X (82K)	T	25/122.7
R2204	7030005050	S.RES ERJ2GEJ 103 X (10K)	T	23.4/122.4
R2205	7030005040	S.RES ERJ2GEJ 472 X (4.7K)	T	18.2/118.2
R2206	7030007270	S.RES ERJ2GEJ 151 X (150)	T	12.6/111.8
R2207	7030005090	S.RES ERJ2GEJ 104 X (100K)	T	23.1/128.5
R2208	7030005090	S.RES ERJ2GEJ 104 X (100K)	T	19/119.2
R2209	7030004980	S.RES ERJ2GEJ 101 X (100)	T	21/116.5
R2211	7030005230	S.RES ERJ2GEJ 334 X (330K)	T	14.5/123.3
R2212	7030005310	S.RES ERJ2GEJ 124 X (120K)	T	12.9/123.3
R2213	7030008010	S.RES ERJ2GEJ 123 X (12K)	T	12.4/124.2
R2214	7030005050	S.RES ERJ2GEJ 103 X (10K)	T	8.8/117.6
R2215	7030005040	S.RES ERJ2GEJ 472 X (4.7K)	T	11.1/120.6
R2217	7030007280	S.RES ERJ2GEJ 331 X (330)	T	24.9/121.5
R2218	7030007270	S.RES ERJ2GEJ 151 X (150)	T	15.5/127.5
R2219	7030007280	S.RES ERJ2GEJ 331 X (330)	T	17.7/126.1
R2220	7030008280	S.RES ERJ2GEJ 271 X (270)	T	16.1/126.1
R2221	7030005050	S.RES ERJ2GEJ 103 X (10K)	T	9.5/120.5
R2230	7030010900	S.RES ERJ3GEYJ 750 V (75)	T	40.4/105.8
R2231	7030005050	S.RES ERJ2GEJ 103 X (10K)	T	4.5/118.2
R2232	7030005050	S.RES ERJ2GEJ 103 X (10K)	T	54.7/117.5
R2251	7030004990	S.RES ERJ2GEJ 221 X (220)	B	6.1/96.9
R2254	7030004990	S.RES ERJ2GEJ 221 X (220)	B	6.8/100.7
R2255	7030004990	S.RES ERJ2GEJ 221 X (220)	B	6.8/101.6
R2256	7030004990	S.RES ERJ2GEJ 221 X (220)	B	6.8/102.5
R2257	7030004990	S.RES ERJ2GEJ 221 X (220)	B	75.3/109
R2258	7030004990	S.RES ERJ2GEJ 221 X (220)	B	70.9/106.5
R2259	7030004990	S.RES ERJ2GEJ 221 X (220)	B	75.3/107.8
R2260	7030004990	S.RES ERJ2GEJ 221 X (220)	B	71/105.6
R2261	7030004990	S.RES ERJ2GEJ 221 X (220)	B	75.3/106.6
R2262	7030004990	S.RES ERJ2GEJ 221 X (220)	B	71.4/104.5
R2263	7030004990	S.RES ERJ2GEJ 221 X (220)	B	75.6/104.5
R2264	7030004990	S.RES ERJ2GEJ 221 X (220)	B	72.2/103.6
R2267	7030004990	S.RES ERJ2GEJ 221 X (220)	T	78.6/104.1
R2268	7030004990	S.RES ERJ2GEJ 221 X (220)	T	78.6/103.2
R2269	7030004990	S.RES ERJ2GEJ 221 X (220)	T	78.6/102.3
R2270	7030004970	S.RES ERJ2GEJ 470 X (47)	T	76.6/101.8
R2271	7030004990	S.RES ERJ2GEJ 221 X (220)	T	76.6/100.9
R2272	7030004990	S.RES ERJ2GEJ 221 X (220)	B	78.1/97.8
R2273	7030004990	S.RES ERJ2GEJ 221 X (220)	B	78.1/98.9
R2274	7030005000	S.RES ERJ2GEJ 471 X (470)	T	14.1/89.7
R2277	7030005090	S.RES ERJ2GEJ 104 X (100K)	T	19.2/89.5
R2278	7030005090	S.RES ERJ2GEJ 104 X (100K)	T	19.2/90.4
R2279	7030005120	S.RES ERJ2GEJ 102 X (1K)	T	66.2/107
R2280	7030004980	S.RES ERJ2GEJ 101 X (100)	B	69.7/110.2
R2281	7030004990	S.RES ERJ2GEJ 221 X (220)	T	7.1/101.5
R2301	7030007250	S.RES ERJ2GEJ 220 X (22)	T	28.3/106.6
R2302	7030008290	S.RES ERJ2GEJ 183 X (18K)	T	28.9/108
R2303	7030005710	S.RES ERJ2GEJ 121 X (120)	T	31.2/110.8
R2304	7030010900	S.RES ERJ3GEYJ 750 V (75)	T	77.7/112
R2311	7030006101	S.RES ERA3YED 183V (18K)	B	67.6/107.1
R2312	7030006571	S.RES ERA3YED 392V (3.9K)	B	68.5/108.3
R2401	7030005000	S.RES ERJ2GEJ 471 X (470)	B	78.7/29.6
R2402	7030005050	S.RES ERJ2GEJ 103 X (10K)	B	81.3/29.6
R2405	7030010040	S.RES ERJ2GEJ-JPW	T	91.9/5.8
R2406	7030004990	S.RES ERJ2GEJ 221 X (220)	B	90.3/100.7
R2408	7030004970	S.RES ERJ2GEJ 470 X (47)	B	90.3/99.8
R2409	7030004990	S.RES ERJ2GEJ 221 X (220)	B	87.1/68.1
R2410	7030004990	S.RES ERJ2GEJ 221 X (220)	B	90.3/65.5
R2411	7030004990	S.RES ERJ2GEJ 221 X (220)	B	87.3/67.2
R2412	7030004990	S.RES ERJ2GEJ 221 X (220)	B	91.3/68.5
R2413	7030004990	S.RES ERJ2GEJ 221 X (220)	B	87.3/66.3
R2414	7030004990	S.RES ERJ2GEJ 221 X (220)	B	90.3/64.6
R2415	7030004990	S.RES ERJ2GEJ 221 X (220)	B	87.3/65.4
R2416	7030004990	S.RES ERJ2GEJ 221 X (220)	B	90.3/63.7
R2417	7030010040	S.RES ERJ2GEJ-JPW	B	51.4/141.2
R2418	7030010040	S.RES ERJ2GEJ-JPW	T	93.3/7.8
R2501	7030005090	S.RES ERJ2GEJ 104 X (100K)	B	8.3/93.3
R2502	7030005090	S.RES ERJ2GEJ 104 X (100K)	B	8/95.1
R2503	7030008410	S.RES ERJ2GEJ 392 X (3.9K)	B	8/91.5
R2505	7030008410	S.RES ERJ2GEJ 392 X (3.9K)	B	10.6/89.2
R2506	7030005720	S.RES ERJ2GEJ 563 X (56K)	B	9.4/90
R2507	7030004980	S.RES ERJ2GEJ 101 X (100)	B	16.4/89.9
R2508	7030005120	S.RES ERJ2GEJ 102 X (1K)	B	10.4/88.3
R2509	7030005120	S.RES ERJ2GEJ 102 X (1K)	B	15.7/88.3
R2510	7030005120	S.RES ERJ2GEJ 102 X (1K)	B	17.4/92.8
R2513	7030005000	S.RES ERJ2GEJ 471 X (470)	B	15.8/94
R2551	7030005120	S.RES ERJ2GEJ 102 X (1K)	B	42.9/123.2
R2552	7030005120	S.RES ERJ2GEJ 102 X (1K)	B	42.9/122.3
R2555	7030004980	S.RES ERJ2GEJ 101 X (100)	B	51.4/119.3
R2556	7030005040	S.RES ERJ2GEJ 472 X (4.7K)	B	44.5/125.2
R2559	7030010040	S.RES ERJ2GEJ-JPW	B	49.5/124.6
R2560	7030008410	S.RES ERJ2GEJ 392 X (3.9K)	B	49.5/125.5
R2561	7030008410	S.RES ERJ2GEJ 392 X (3.9K)	B	52.9/124.7
R2562	7030008410	S.RES ERJ2GEJ 392 X (3.9K)	B	53.9/122.8
R2564	7030005090	S.RES ERJ2GEJ 104 X (100K)	B	46.1/126.1

[MAIN UNIT]

REF NO.	PARTS NO.	DESCRIPTION	M.	H/V LOCATION
R2565	7030009280	S.RES ERJ2GEJ 391 X	B	41.8/116.9
R2566	7030005050	S.RES ERJ2GEJ 103 X (10K)	B	59/126.8
R2567	7030005050	S.RES ERJ2GEJ 103 X (10K)	B	60.6/126.8
R2568	7030005040	S.RES ERJ2GEJ 472 X (4.7K)	B	47.8/124.7
R2569	7030005040	S.RES ERJ2GEJ 472 X (4.7K)	B	46.1/125.2
R2601	7030010040	S.RES ERJ2GEJ-JPW	B	66.7/123.4
R2602	7030005000	S.RES ERJ2GEJ 471 X (470)	B	57.2/122.6
R2603	7030005240	S.RES ERJ2GEJ 473 X (47K)	B	63.4/121.7
R2604	7030008400	S.RES ERJ2GEJ 182 X (1.8K)	B	66.7/124.3
R2605	7030005120	S.RES ERJ2GEJ 102 X (1K)	B	65.5/126
R2607	7030010040	S.RES ERJ2GEJ-JPW	T	40.5/132.1
R2608	7030009320	S.RES ERJ2GEJ 4R7 X (4.7)	B	83.9/132.7
R2611	7030005050	S.RES ERJ2GEJ 103 X (10K)	B	33.9/124.8
R2612	7030005090	S.RES ERJ2GEJ 104 X (100K)	B	38.4/125.4
R2613	7030005080	S.RES ERJ2GEJ 823 X (82K)	B	38.4/123.6
R2614	7030005120	S.RES ERJ2GEJ 102 X (1K)	B	34.7/126.6
R2617	7030005040	S.RES ERJ2GEJ 472 X (4.7K)	T	63.3/111.1
R2618	7030007340	S.RES ERJ2GEJ 153 X (15K)	T	69.3/112.6
R2619	7030005060	S.RES ERJ2GEJ 333 X (33K)	T	63.3/112.1
R2620	7030005120	S.RES ERJ2GEJ 102 X (1K)	T	78.1/100.3
R2621	7030005120	S.RES ERJ2GEJ 102 X (1K)	T	78.1/99.4
R2623	7030005240	S.RES ERJ2GEJ 473 X (47K)	T	9.8/112.9
R2624	7030004970	S.RES ERJ2GEJ 470 X (47)	B	86.8/122
R2628	7030005240	S.RES ERJ2GEJ 473 X (47K)	B	61.8/121.7
C5	4030017460	S.CER ECJ0EB1E102K	B	47.5/30.7
C6	4030018960	S.CER C3216 JB 1C 106MT-N	T	66.3/12
C7	4030017330	S.CER ECJ0EF1C104Z	T	73.1/12.2
C8	4030017330	S.CER ECJ0EF1C104Z	T	77.2/19.1
C9	4030017330	S.CER ECJ0EF1C104Z	T	73.1/14
C10	4030017330	S.CER ECJ0EF1C104Z	T	74.8/14.9
C11	4030017330	S.CER ECJ0EF1C104Z	T	73/17.6
C12	4030017330	S.CER ECJ0EF1C104Z	T	76.4/16.7
C13	4030017330	S.CER ECJ0EF1C104Z	T	72.6/16.7
C14	4030017460	S.CER ECJ0EB1E102K	T	67.7/16.5
C15	4030017460	S.CER ECJ0EB1E102K	T	63.7/14.7
C16	4030017460	S.CER ECJ0EB1E102K	T	63.7/15.6
C17	4030017460	S.CER ECJ0EB1E102K	T	62.3/18.8
C18	4030017620	S.CER ECJ0EC1H100C	T	60.7/18.9
C21	4030017730	S.CER ECJ0EB1E471K	T	64.5/13.8
C25	4030017580	S.CER ECJ0EC1H060C	T	55.2/17.8
C26	4030017660	S.CER ECJ0EC1H330J	T	55.2/18.7
C27	4030017780	S.CER ECJ0EB1E472K	T	51.6/20.5
C28	4030017530	S.CER ECJ0EC1H0R5B	T	53.8/17.1
C29	4030017590	S.CER ECJ0EC1H070C	T	51.7/19.6
C30	4030017730	S.CER ECJ0EB1E471K	T	45.8/17.5
C31	4030017530	S.CER ECJ0EC1H0R5B	T	53.8/16.2
C32	4030017660	S.CER ECJ0EC1H330J	T	52.1/17.4
C33	4030017580	S.CER ECJ0EC1H060C	T	52.2/16.5
C34	4030017380	S.CER ECJ0EC1H050B	T	56/15
C35	4030017380	S.CER ECJ0EC1H050B	T	55.9/12.4
C36	4030017730	S.CER ECJ0EB1E471K	T	51/15.6
C37	4030017780	S.CER ECJ0EB1E472K	T	70.4/11.3
C38	4030017780	S.CER ECJ0EB1E472K	T	45.8/18.4
C40	4030017730	S.CER ECJ0EB1E471K	T	73.1/13.1
C41	4030017730	S.CER ECJ0EB1E471K	T	66.9/19.6
C42	4030017730	S.CER ECJ0EB1E471K	T	70.4/12.2
C43	4030017420	S.CER ECJ0EC1H470J	T	45.8/16.6
C44	4030017420	S.CER ECJ0EC1H470J	T	48/11.7
C50	4030017640	S.CER ECJ0EC1H150J	B	80.4/13.6
C51	4030017640	S.CER ECJ0EC1H150J	B	79.9/11.8
C52	4030017430	S.CER ECJ0EC1H101J	B	79.9/12.7
C53	4030016930	S.CER ECJ0EB1A104K	B	79.6/22
C54	4030016930	S.CER ECJ0EB1A104K	T	79.8/12.9
C55	4030016930	S.CER ECJ0EB1A104K	T	78.1/17.9
C56	4030018860	S.CER ECJ0EB0J105K	B	65.5/22.7
C58	4030017710	S.CER ECJ0EC1H181J	T	72.2/19.4
C59	4030017710	S.CER ECJ0EC1H181J	T	65.4/23.7
C101	4030017330	S.CER ECJ0EF1C104Z	T	10.3/15.5
C102	4030017330	S.CER ECJ0EF1C104Z	T	13.2/16.9
C103	4030017330	S.CER ECJ0EF1C104Z	T	13.2/17.8
C104	4030017330	S.CER ECJ0EF1C104Z	T	3.3/29.9
C105	4030017330	S.CER ECJ0EF1C104Z	T	13.2/19.6
C106	4030017850	S.CER C2012 CH 1H 272J-T	T	23.7/10.9
C107	4030017330	S.CER ECJ0EF1C104Z	T	19.2/12.9
C108	4030017330	S.CER ECJ0EF1C104Z	T	36.5/16.6
C109	4030017330	S.CER ECJ0EF1C104Z	T	25.2/14
C110	4030017800	S.CER C1608 CH 1H 561J-T	T	27.8/7.7
C111	4030018590	S.CER C1608 CH 1H 122J-T	T	29.1/5
C112	4030017330	S.CER ECJ0EF1C104Z	T	23.8/5.3
C114	4030018600	S.CER C1608 CH 1H 152J-T	T	25.1/15
C115	4030008490	S.CER C2012 JB 1H 682K-T	T	24.8/16.7
C116	4030017850	S.CER C2012 CH 1H 272J-T	T	24.8/18.4
C117	4030017330	S.CER ECJ0EF1C104Z	T	19.8/7
C118	4030017330	S.CER ECJ0EF1C104Z	T	38.2/17.5
C119	4030017780	S.CER ECJ0EB1E472K	T	7.8/22.2
C1				

[MAIN UNIT]

REF NO.	PARTS NO.	DESCRIPTION	M.	H/V LOCATION
C210	4030017610	S.CER ECJ0EC1H090C	T	18.5/40.5
C211	4030017700	S.CER ECJ0EC1H151J	T	18.5/42.3
C212	4030017650	S.CER ECJ0EC1H270J	T	23.2/39.2
C213	4030017510	S.CER ECJ0EC1H680J	T	21.8/43.4
C214	4030018820	S.CER ECJ0EB1H561K	T	31.7/54.4
C215	4030017440	S.CER ECJ0EC1H221J	T	37/54.6
C226	4030017330	S.CER ECJ0EF1C104Z	T	24.1/43.4
C227	4030017330	S.CER ECJ0EF1C104Z	T	19.7/30.3
C228	4030017430	S.CER ECJ0EC1H101J	T	28.1/39.2
C229	4030017440	S.CER ECJ0EC1H221J	T	29.7/39.2
C237	4030017500	S.CER ECJ0EC1H560J	T	28.1/38.2
C238	4030017330	S.CER ECJ0EF1C104Z	T	21.9/30.9
C239	4030017330	S.CER ECJ0EF1C104Z	B	24.7/41.4
C240	4030017400	S.CER ECJ0EC1H220J	B	28.1/43.6
C241	4030017580	S.CER ECJ0EC1H060C	B	31.5/40.1
C242	4030017680	S.CER ECJ0EC1H820J	B	31.5/41
C243	4030018630	S.CER C2012 CH 1H 472J-T	T	32.5/57.8
C244	4030018680	S.CER C2012 CH 1H 822J-T	T	36.8/57.8
C245	4030017330	S.CER ECJ0EF1C104Z	T	45.8/63.2
C246	4030018600	S.CER C1608 CH 1H 152J-T	T	36.5/56.1
C247	4030017860	S.CER C2012 CH 1H 332J-T	T	40.3/54.1
C248	4030018630	S.CER C2012 CH 1H 472J-T	T	43.8/57.9
C249	4030017330	S.CER ECJ0EF1C104Z	B	24.9/56.4
C250	4030017330	S.CER ECJ0EF1C104Z	B	24.9/53.3
C251	4030018590	S.CER C1608 CH 1H 122J-T	T	30.5/51
C252	4030011340	S.CER C1608 CH 1H 471J-T	T	31.9/48.6
C253	4030018630	S.CER C2012 CH 1H 472J-T	T	29.1/53.3
C254	4030018620	S.CER C1608 CH 1H 222J-T	T	38.1/50.8
C255	4030018580	S.CER C1608 CH 1H 821J-T	T	32.6/55.9
C256	4030010760	S.CER C1608 CH 1H 331J-T	T	38.1/52.1
C257	4030018610	S.CER C1608 CH 1H 182J-T	T	34.4/53.4
C258	4030017870	S.CER C1608 CH 1H 681J-T	T	40.7/52.2
C259	4030018590	S.CER C1608 CH 1H 122J-T	T	37.1/53.4
C260	4030017870	S.CER C1608 CH 1H 681J-T	T	40.7/47.9
C261	4030017780	S.CER ECJ0EB1E472K	B	37.9/56.2
C262	4030017780	S.CER ECJ0EB1E472K	B	37.9/53.8
C263	4030017330	S.CER ECJ0EF1C104Z	B	24.5/50.2
C264	4030017330	S.CER ECJ0EF1C104Z	B	23.9/47.1
C265	4030011280	S.CER C1608 CH 1H 271J-T	B	36.4/46
C266	4030017700	S.CER ECJ0EC1H151J	B	31/44.1
C267	4030018590	S.CER C1608 CH 1H 122J-T	B	36.4/49.6
C268	4030018580	S.CER C1608 CH 1H 821J-T	B	31.7/42.9
C269	4030017710	S.CER ECJ0EC1H181J	B	36.5/47.1
C270	4030017430	S.CER ECJ0EC1H101J	B	32.6/44.1
C271	4030011330	S.CER C1608 CH 1H 391J-T	B	36.4/48.3
C272	4030011280	S.CER C1608 CH 1H 271J-T	B	36.3/43.8
C273	4030011330	S.CER C1608 CH 1H 391J-T	B	38.8/47.3
C274	4030017730	S.CER ECJ0EB1E471K	B	34.2/43.7
C275	4030017780	S.CER ECJ0EB1E472K	B	42.9/49.6
C276	4030017780	S.CER ECJ0EB1E472K	B	39.2/46.2
C278	4030017330	S.CER ECJ0EF1C104Z	T	30.9/31.8
C279	4030017330	S.CER ECJ0EF1C104Z	T	31/43.8
C281	4030017330	S.CER ECJ0EF1C104Z	T	33/31.7
C282	4030017580	S.CER ECJ0EC1H060C	B	31.5/39.2
C283	4030017330	S.CER ECJ0EF1C104Z	B	35.8/35.8
C284	4030017780	S.CER ECJ0EB1E472K	B	42.6/43.3
C285	4030017380	S.CER ECJ0EC1H050B	B	33.1/39.5
C286	4030017510	S.CER ECJ0EC1H680J	B	34.7/39.5
C287	4030017690	S.CER ECJ0EC1H121J	B	36.5/37.8
C288	4030017680	S.CER ECJ0EC1H820J	B	34.2/36.3
C289	4030017420	S.CER ECJ0EC1H470J	B	36.3/36.7
C290	4030018600	S.CER C1608 CH 1H 152J-T	B	38.8/37.6
C291	4030017680	S.CER ECJ0EC1H820J	B	37.9/36.5
C292	4030017330	S.CER ECJ0EF1C104Z	T	30.9/30
C293	4030017780	S.CER ECJ0EB1E472K	B	38.1/34.8
C294	4030017440	S.CER ECJ0EC1H221J	T	38.6/49.6
C295	4030017510	S.CER ECJ0EC1H680J	T	40.4/51.2
C301	4030017330	S.CER ECJ0EF1C104Z	T	47/30.1
C302	4030017330	S.CER ECJ0EF1C104Z	B	56.1/30.7
C303	4030017330	S.CER ECJ0EF1C104Z	T	51.5/33.6
C305	4030017330	S.CER ECJ0EF1C104Z	T	59.9/34.7
C307	4030017330	S.CER ECJ0EF1C104Z	T	59.9/35.6
C308	4030017330	S.CER ECJ0EF1C104Z	T	60.7/36.5
C309	4030017330	S.CER ECJ0EF1C104Z	T	62.8/36.9
C310	4030017330	S.CER ECJ0EF1C104Z	T	60.9/30.1
C311	4030017330	S.CER ECJ0EF1C104Z	T	50.1/32.6
C312	4030017330	S.CER ECJ0EF1C104Z	T	64.5/36.1
C313	4030017380	S.CER ECJ0EC1H050B	T	46.4/23
C314	4030017660	S.CER ECJ0EC1H330J	T	64.8/35.2
C315	4030017340	S.CER ECJ0EC1H010B	T	49.2/22.9
C316	4030017630	S.CER ECJ0EC1H120J	T	66.1/36.1
C317	4030017600	S.CER ECJ0EC1H080C	T	51.4/23.8
C318	4030017680	S.CER ECJ0EC1H820J	T	66.4/35.2
C319	4030017570	S.CER ECJ0EC1H040B	T	53/24.3
C320	4030017570	S.CER ECJ0EC1H040B	T	69.6/37.1
C321	4030017580	S.CER ECJ0EC1H060C	T	58.6/24.4
C322	4030017670	S.CER ECJ0EC1H390J	T	69/32.2
C323	4030017590	S.CER ECJ0EC1H070C	T	60.4/24.2
C324	4030017330	S.CER ECJ0EF1C104Z	T	74.7/38.6
C325	4030017360	S.CER ECJ0EC1H030B	T	62/24.6
C326	4030017780	S.CER ECJ0EB1E472K	T	47.6/47.1
C401	4030017330	S.CER ECJ0EF1C104Z	T	71/30.8
C413	4030017330	S.CER ECJ0EF1C104Z	T	80.6/23.9
C415	4030017330	S.CER ECJ0EF1C104Z	T	71.9/24
C418	4030017330	S.CER ECJ0EF1C104Z	T	67.4/24.8
C422	4030017330	S.CER ECJ0EF1C104Z	T	80/28.6
C423	4030017330	S.CER ECJ0EF1C104Z	T	67.4/23.9

[MAIN UNIT]

REF NO.	PARTS NO.	DESCRIPTION	M.	H/V LOCATION
C424	4030017330	S.CER ECJ0EF1C104Z	T	83.2/21
C425	4030017330	S.CER ECJ0EF1C104Z	T	86.9/27.6
C426	4030017330	S.CER ECJ0EF1C104Z	T	78.6/19.8
C427	4030017330	S.CER ECJ0EF1C104Z	T	80/27.7
C429	4030017460	S.CER ECJ0EB1E102K	T	81.8/25.3
C431	4030017330	S.CER ECJ0EF1C104Z	T	88.5/26.7
C432	4030017780	S.CER ECJ0EB1E472K	B	88.5/19.3
C433	4030017780	S.CER ECJ0EB1E472K	T	88.8/20.3
C434	4030017780	S.CER ECJ0EB1E472K	T	86.7/22.9
C511	4030017460	S.CER ECJ0EB1E102K	T	41.8/26.8
C512	4030017780	S.CER ECJ0EB1E472K	T	93.6/33.5
C513	4030017330	S.CER ECJ0EF1C104Z	T	88.4/28.3
C514	4030017330	S.CER ECJ0EF1C104Z	B	88.3/31.7
C515	4030017780	S.CER ECJ0EB1E472K	T	81.7/33.2
C516	4030017580	S.CER ECJ0EC1H060C	T	86.1/38.7
C518	4030017570	S.CER ECJ0EC1H040B	T	86.9/36.5
C525	4030017330	S.CER ECJ0EF1C104Z	T	81.8/32.3
C526	4030016790	S.CER ECJ0EB1C103K	T	77.9/38.2
C527	4030017330	S.CER ECJ0EF1C104Z	T	79.5/37.9
C528	4030017330	S.CER ECJ0EF1C104Z	T	89.7/35.1
C529	4030017670	S.CER ECJ0EC1H390J	T	91.3/33.8
C530	4030017460	S.CER ECJ0EB1E102K	B	87.7/34.1
C602	4030017570	S.CER ECJ0EC1H040B	B	85.7/39.6
C603	4030017780	S.CER ECJ0EB1E472K	T	89.1/40.1
C604	4030017780	S.CER ECJ0EB1E472K	T	94/46.5
C605	4030017620	S.CER ECJ0EC1H100C	T	86/44.2
C606	4030017620	S.CER ECJ0EC1H100C	B	85.7/41.4
C608	4030017550	S.CER ECJ0EC1H1R5B	B	82.7/43.8
C609	4030017580	S.CER ECJ0EC1H060C	B	78.6/46.8
C610	4030017620	S.CER ECJ0EC1H100C	B	80.7/48.1
C611	4030017780	S.CER ECJ0EB1E472K	B	85.1/37.5
C612	4030017610	S.CER ECJ0EC1H090C	T	79.5/40.5
C613	4030017620	S.CER ECJ0EC1H100C	T	76.5/43.7
C614	4030017780	S.CER ECJ0EB1E472K	T	69.6/38.8
C615	4030017780	S.CER ECJ0EB1E472K	T	64.3/43
C616	4030017780	S.CER ECJ0EB1E472K	T	77.4/39.5
C617	4030017620	S.CER ECJ0EC1H100C	B	85.7/40.5
C618	4030017620	S.CER ECJ0EC1H100C	B	80.7/49
C701	4030017330	S.CER ECJ0EF1C104Z	T	59/50.6
C702	4030017330	S.CER ECJ0EF1C104Z	T	63/45
C703	4510008630	S.ELE 16 CE 47 FE	B	59/44.9
C704	4030017780	S.CER ECJ0EB1E472K	T	58.6/42.9
C705	4030017600	S.CER ECJ0EC1H080C	T	59.6/45.1
C707	4030017330	S.CER ECJ0EF1C104Z	T	64.2/52.9
C708	4030017460	S.CER ECJ0EB1E102K	T	64.5/55
C709	4030017780	S.CER ECJ0EB1E472K	T	60.7/58.6
C710	4030017780	S.CER ECJ0EB1E472K	T	62.3/58.6
C711	4030017460	S.CER ECJ0EB1E102K	T	57.1/50.6
C712	4030017600	S.CER ECJ0EC1H080C	T	52.4/50.2
C714	4030017460	S.CER ECJ0EB1E102K	T	56.2/49.7
C715	4030017780	S.CER ECJ0EB1E472K	T	52.1/53.2
C716	4030017340	S.CER ECJ0EC1H010B	T	55.3/55.1
C717	4030017780	S.CER ECJ0EB1E472K	T	51.2/52.3
C718	4030017780	S.CER ECJ0EB1E472K	T	56.9/55.1
C719	4030017340	S.CER ECJ0EC1H010B	T	61.1/53.9
C720	4030017380	S.CER ECJ0EC1H050B	T	59.3/42
C721	4030017780	S.CER ECJ0EB1E472K	T	51.2/49.6
C801	4030017330	S.CER ECJ0EF1C104Z	T	71.5/64
C803	4030017780	S.CER ECJ0EB1E472K	T	65.3/61.8
C804	4030017330	S.CER ECJ0EF1C104Z	T	91.9/58
C805	4030017460	S.CER ECJ0EB1E102K	T	83.5/55.8
C807	4030017330	S.CER ECJ0EF1C104Z	T	60.6/66.7
C808	4030017870	S.CER C1608 CH 1H 681J-T	T	60.3/65.5
C809	4030018630	S.CER C2012 CH 1H 472J-T	T	57.4/66.8
C810	4030017700	S.CER ECJ0EC1H151J	T	63.9/68.5
C811	4030017700	S.CER ECJ0EC1H151J	T	63.9/69.4
C812	4030017700	S.CER ECJ0EC1H151J	T	60.1/69.4
C813	4030017700	S.CER ECJ0EC1H151J	T	60.1/68.5
C814	4030017330	S.CER ECJ0EF1C104Z	T	88.5/57.1
C815	4030017460	S.CER ECJ0EB1E102K	T	86.6/60.6
C816	4030017400	S.CER ECJ0EC1H220J	T	85.7/59.7
C817	4030017400	S.CER ECJ0EC1H220J	T	84/61.7
C818	4030018590	S.CER C1608 CH 1H 122J-T	T	54.6/65.6
C819	4030017850	S.CER C2012 CH 1H 272J-T	T	51.6/65.8
C901	4030017330	S.CER ECJ0EF1C104Z	T	38.4/71.3
C910	4030017710	S.CER ECJ0EC1H181J	T	39.2/65.6
C911	4030017700	S.CER ECJ0EC1H151J	T	47.9/74.7
C913	4030017330	S.CER ECJ0EF1C104Z	T	38.2/61.1
C914	4030017330	S.CER ECJ0EF1C104Z	T	39.2/63.6
C916	4030017330	S.CER ECJ0EF1C104Z	T	33.9/61.9
C917	4030017780	S.CER ECJ0EB1E472K	T	35.6/63.2
C918	4030017330	S.CER ECJ0EF1C104Z	T	34.2/67.5
C920	4030017460	S.CER ECJ0EB1E102K	T	38.4/74.2
C921	4030017330	S.CER ECJ0EF1C104Z	T	34.2/70.2
C922	4030017330	S.CER ECJ0EF1C104Z	T	29.4/73
C923	4030017330	S.CER ECJ0EF1C104Z	T	29.9/72.1
C924	4030017780	S.CER ECJ0EB1E472K	T	41.2/74.1
C925	4030017700	S.CER ECJ0EC1H151J	B	31.4/73
C1001	4030017780	S.CER ECJ0EB1E472K	T	31.7/71.2
C1009	4030017780	S.CER ECJ0EB1E472K	T	25.8/72
C1016	4030017330	S.CER ECJ0EF1C104Z	T	

[MAIN UNIT]

REF NO.	PARTS NO.	DESCRIPTION	M.	H/V LOCATION
C1101	4030017490	S.CER C1608 JB 1A 105K-T	T	2.5/78.9
C1102	4030017330	S.CER ECJ0EF1C104Z	T	4.6/78
C1104	4030017490	S.CER C1608 JB 1A 105K-T	T	2.5/87.8
C1105	4030018960	S.CER C3216 JB 1C 106MT-N	T	2.9/89.7
C1108	4030017330	S.CER ECJ0EF1C104Z	T	2.3/91.3
C1201	4030017330	S.CER ECJ0EF1C104Z	T	26.6/80.6
C1202	4030017330	S.CER ECJ0EF1C104Z	T	28.7/80.5
C1203	4030017330	S.CER ECJ0EF1C104Z	T	18.6/79.2
C1204	4030018960	S.CER C3216 JB 1C 106MT-N	T	9/76.9
C1206	4030017780	S.CER ECJ0EB1E472K	T	14.3/79.4
C1207	4030017780	S.CER ECJ0EB1E472K	T	12.7/78.5
C1208	4030018080	S.CER ECJ0EB1H182K	T	12.9/85
C1209	4030018820	S.CER ECJ0EB1H561K	T	12.9/84.1
C1210	4030017780	S.CER ECJ0EB1E472K	T	11.3/84.1
C1211	4030017490	S.CER C1608 JB 1A 105K-T	T	9.2/84.5
C1212	4030017490	S.CER C1608 JB 1A 105K-T	T	6.7/87.8
C1213	4030017330	S.CER ECJ0EF1C104Z	T	21.8/78.3
C1301	4030017330	S.CER ECJ0EF1C104Z	T	15.2/73.6
C1302	4030017330	S.CER ECJ0EF1C104Z	T	15.1/67.3
C1303	4030018860	S.CER ECJ0EB0J105K	T	11.3/67.3
C1304	4030017330	S.CER ECJ0EF1C104Z	T	14.3/69.2
C1305	4030017330	S.CER ECJ0EF1C104Z	T	11.6/65.5
C1306	4030017330	S.CER ECJ0EF1C104Z	T	10.9/60.3
C1307	4030017330	S.CER ECJ0EF1C104Z	T	16.2/65.6
C1308	4030017330	S.CER ECJ0EF1C104Z	T	14.5/60.3
C1309	4030017330	S.CER ECJ0EF1C104Z	T	3.8/50.8
C1310	4030017330	S.CER ECJ0EF1C104Z	T	16.2/62.9
C1311	4030018960	S.CER C3216 JB 1C 106MT-N	T	5.4/58.5
C1312	4030018860	S.CER ECJ0EB0J105K	T	13/66.4
C1401	4030017330	S.CER ECJ0EF1C104Z	B	46.6/77.3
C1402	4030017700	S.CER ECJ0EC1H151J	B	42/69.6
C1403	4030017650	S.CER ECJ0EC1H270J	B	45.5/71.4
C1404	4030017700	S.CER ECJ0EC1H151J	B	41.9/70.5
C1405	4030017780	S.CER ECJ0EB1E472K	B	43.6/71.4
C1406	4030017780	S.CER ECJ0EB1E472K	B	42/72.4
C1407	4030017780	S.CER ECJ0EB1E472K	B	44.6/74.3
C1408	4030017780	S.CER ECJ0EB1E472K	B	40.3/79
C1409	4030017780	S.CER ECJ0EB1E472K	B	34.7/79
C1411	4030018860	S.CER ECJ0EB0J105K	B	27/79.9
C1412	4030016950	S.CER ECJ0EB1A473K	B	27/80.8
C1413	4030017490	S.CER C1608 JB 1A 105K-T	B	20.7/77.4
C1414	4030016950	S.CER ECJ0EB1A473K	B	25/77.8
C1415	4510008640	S.ELE 6 CE 100 FE	B	13.2/81.2
C1416	4030016950	S.CER ECJ0EB1A473K	B	20.2/78.5
C1418	4030017350	S.CER ECJ0EC1H020B	B	23/86.6
C1419	4030018390	S.CER ECJ0EB1A563K	B	23/87.5
C1420	4030017420	S.CER ECJ0EC1H470J	B	17.8/83
C1421	4030018960	S.CER C3216 JB 1C 106MT-N	B	19.8/87.3
C1422	4030017640	S.CER ECJ0EC1H150J	B	17.8/82.1
C1423	4610001970	S.TRI TZC3P200A110R00 (TZC03P200A1102)	T	3.8/72.5
C1491	4030017670	S.CER ECJ0EC1H390J	[EUR] B	88.2/29.3
	4030017670	S.CER ECJ0EC1H390J	[FRA]	
	4030017670	S.CER ECJ0EC1H390J	[ESP]	
	4030017400	S.CER ECJ0EC1H220J	[USA]	
	4030017670	S.CER ECJ0EC1H390J	[EXP]	
	4030017670	S.CER ECJ0EC1H390J	[ITR]	
	4030017670	S.CER ECJ0EC1H390J	[UK]	
	4030017400	S.CER ECJ0EC1H220J	[KOR]	
	4030017670	S.CER ECJ0EC1H390J	[AUS]	
	4030017670	S.CER ECJ0EC1H390J	[CHN]	
C1493	4030017660	S.CER ECJ0EC1H330J	B	86.1/33.7
C1494	4030017670	S.CER ECJ0EC1H390J	[EUR] B	83.6/34
	4030017670	S.CER ECJ0EC1H390J	[FRA]	
	4030017670	S.CER ECJ0EC1H390J	[ESP]	
	4030017420	S.CER ECJ0EC1H470J	[USA]	
	4030017670	S.CER ECJ0EC1H390J	[EXP]	
	4030017670	S.CER ECJ0EC1H390J	[ITR]	
	4030017670	S.CER ECJ0EC1H390J	[UK]	
	4030017420	S.CER ECJ0EC1H470J	[KOR]	
	4030017670	S.CER ECJ0EC1H390J	[AUS]	
	4030017670	S.CER ECJ0EC1H390J	[CHN]	
C1495	4030011280	S.CER C1608 CH 1H 271J-T	B	84/32.9
	4030011280	S.CER C1608 CH 1H 271J-T	[FRA]	
	4030011280	S.CER C1608 CH 1H 271J-T	[ESP]	
	4030010760	S.CER C1608 CH 1H 331J-T	[USA]	
	4030011280	S.CER C1608 CH 1H 271J-T	[EXP]	
	4030011280	S.CER C1608 CH 1H 271J-T	[ITR]	
	4030011280	S.CER C1608 CH 1H 271J-T	[UK]	
	4030010760	S.CER C1608 CH 1H 331J-T	[KOR]	
	4030011280	S.CER C1608 CH 1H 271J-T	[AUS]	
	4030011280	S.CER C1608 CH 1H 271J-T	[CHN]	
C1496	4030017660	S.CER ECJ0EC1H330J	B	79.3/35.3
C1498	4030017670	S.CER ECJ0EC1H390J	[EUR] B	79.3/36.2
	4030017670	S.CER ECJ0EC1H390J	[FRA]	
	4030017670	S.CER ECJ0EC1H390J	[ESP]	
	4030017400	S.CER ECJ0EC1H220J	[USA]	
	4030017670	S.CER ECJ0EC1H390J	[EXP]	
	4030017670	S.CER ECJ0EC1H390J	[ITR]	
	4030017670	S.CER ECJ0EC1H390J	[UK]	
	4030017400	S.CER ECJ0EC1H220J	[KOR]	
	4030017670	S.CER ECJ0EC1H390J	[AUS]	
	4030017670	S.CER ECJ0EC1H390J	[CHN]	
C1501	4030017410	S.CER ECJ0EC1H240J	B	79.3/37.1
C1503	4030017330	S.CER ECJ0EF1C104Z	B	78.9/61.9

[MAIN UNIT]

REF NO.	PARTS NO.	DESCRIPTION	M.	H/V LOCATION
C1504	4030017510	S.CER ECJ0EC1H680J	B	80.9/36.4
C1506	4030017780	S.CER ECJ0EB1E472K	B	92.1/28.8
C1507	4030017410	S.CER ECJ0EC1H240J	B	85.2/36.4
C1508	4030017780	S.CER ECJ0EB1E472K	B	77.3/38.6
C1509	4030017780	S.CER ECJ0EB1E472K	B	72.4/39.1
C1510	4030017780	S.CER ECJ0EB1E472K	B	72.4/41.2
C1511	4030016790	S.CER ECJ0EB1C103K	B	86.4/56.2
C1512	4030017780	S.CER ECJ0EB1E472K	B	77/41.6
C1513	4030018900	S.CER ECJ0EB0J474K	B	73.6/55.1
C1514	4030017780	S.CER ECJ0EB1E472K	B	73.5/42.1
C1515	4030018960	S.CER C3216 JB 1C 106MT-N	B	68.3/53.7
C1516	4030017330	S.CER ECJ0EF1C104Z	B	77.3/49
C1517	4030017730	S.CER ECJ0EB1E471K	B	73.4/53.9
C1518	4030016790	S.CER ECJ0EB1C103K	B	85.7/51.4
C1519	4030018960	S.CER C3216 JB 1C 106MT-N	B	69.3/47.4
C1520	4510008630	S.ELE 16 CE 47 FE	B	91/45.4
C1521	4030017680	S.CER ECJ0EC1H820J	B	85.9/58
C1522	4030017670	S.CER ECJ0EC1H390J	T	73.2/55.3
C1523	4030017330	S.CER ECJ0EF1C104Z	T	31.2/80.4
C1524	4030017420	S.CER ECJ0EC1H470J	[EUR] B	73.6/60.5
	4030017420	S.CER ECJ0EC1H470J	[FRA]	
	4030017420	S.CER ECJ0EC1H470J	[ESP]	
	4030017510	S.CER ECJ0EC1H680J	[USA]	
	4030017420	S.CER ECJ0EC1H470J	[EXP]	
	4030017420	S.CER ECJ0EC1H470J	[ITR]	
	4030017420	S.CER ECJ0EC1H470J	[UK]	
	4030017510	S.CER ECJ0EC1H680J	[KOR]	
	4030017420	S.CER ECJ0EC1H470J	[AUS]	
	4030017420	S.CER ECJ0EC1H470J	[CHN]	
C1525	4030018900	S.CER ECJ0EB0J474K	B	85.8/59.9
C1526	4030018960	S.CER C3216 JB 1C 106MT-N	B	69.3/51.5
C1531	4030017490	S.CER C1608 JB 1A 105K-T	B	82.8/48.3
C1532	4030017780	S.CER ECJ0EB1E472K	B	81.9/41.3
C1533	4030017780	S.CER ECJ0EB1E472K	B	81.9/39.4
C1534	4030017780	S.CER ECJ0EB1E472K	B	83.5/38.5
C1601	4030017780	S.CER ECJ0EB1E472K	T	6.3/52.2
C1604	4030017780	S.CER ECJ0EB1E472K	T	5.6/50.8
C1605	4030017330	S.CER ECJ0EF1C104Z	T	8.8/48.7
C1607	4030017780	S.CER ECJ0EB1E472K	T	14.7/46
C1609	4030017490	S.CER C1608 JB 1A 105K-T	T	14.1/33.6
C1610	4030017330	S.CER ECJ0EF1C104Z	T	12.1/44.7
C1611	4030017330	S.CER ECJ0EF1C104Z	T	14.6/41.1
C1613	4030017330	S.CER ECJ0EF1C104Z	T	18.9/47.1
C1614	4030017730	S.CER ECJ0EB1E471K	T	15/36.1
C1615	4030017420	S.CER ECJ0EC1H470J	T	10.4/46.9
C1616	4550007260	S.TAN F931C475MAABMA	T	9.6/50.5
C1618	4030017430	S.CER ECJ0EC1H101J	T	12.7/26.3
C1701	4030017490	S.CER C1608 JB 1A 105K-T	B	55.1/50.4
C1702	4030017490	S.CER C1608 JB 1A 105K-T	B	55/69.6
C1801	4030017330	S.CER ECJ0EF1C104Z	B	18.4/105
C1802	4510008630	S.ELE 16 CE 47 FE	B	14.4/101.2
C1803	4030018960	S.CER C3216 JB 1C 106MT-N	B	22.3/112.1
C1804	4030017330	S.CER ECJ0EF1C104Z	B	22.8/110.6
C1901	4030017330	S.CER ECJ0EF1C104Z	T	36.2/80.4
C1902	4030017330	S.CER ECJ0EF1C104Z	T	33.7/80.4
C1903	4030017330	S.CER ECJ0EF1C104Z	T	23.3/18.8
C1904	4030017330	S.CER ECJ0EF1C104Z	B	32.5/89.8
C1905	4030017330	S.CER ECJ0EF1C104Z	B	25.9/33.8
C1906	4030017330	S.CER ECJ0EF1C104Z	B	25.9/32.9
C1907	4030017330	S.CER ECJ0EF1C104Z	T	41.6/80.3
C1908	4030017330	S.CER ECJ0EF1C104Z	T	38.4/80.7
C1909	4030017330	S.CER ECJ0EF1C104Z	B	21.6/13.9
C1910	4030017460	S.CER ECJ0EB1E102K	B	45.4/25.4
C1916	4030018960	S.CER C3216 JB 1C 106MT-N	B	14.7/50.5
C1917	4030018960	S.CER C3216 JB 1C 106MT-N	B	5.3/52.7
C1951	4030018960	S.CER C3216 JB 1C 106MT-N	B	48.1/103.1
C1952	4030018960	S.CER C3216 JB 1C 106MT-N	B	48.1/98.9
C1953	4030018960	S.CER C3216 JB 1C 106MT-N	B	48.1/96.8
C1954	4030018960	S.CER C3216 JB 1C 106MT-N	B	48.6/105.2
C1955	4030018960	S.CER C3216 JB 1C 106MT-N	B	48.1/101
C1956	4030018960	S.CER C3216 JB 1C 106MT-N	B	60.9/18.7
C1957	4030017330	S.CER ECJ0EF1C104Z	B	63.8/116.7
C1958	4030018910	S.CER C1608 JB 0J 475K-T	B	20.9/125.7
C1959	4550007090	S.TAN TEESVA 1A 226M8R	B	11.6/120.2
C1960	4030010210	S.CER C3216 JB 1C 105M-T	B	47.3/109.7
C1961	4030017730	S.CER ECJ0EB1E471K	B	44/110
C1962	4030017440	S.CER ECJ0EC1H221J	B	44.6/108.4
C1963	4030017500	S.CER ECJ0EC1H560J	B	35.3/105.1
C1964	4030017330	S.CER ECJ0EF1C104Z	B	44.3/111.3
C1965	4030018960	S.CER C3216 JB 1C 106MT-N	B	7.4/108
C1966	4030017330	S.CER ECJ0EF1C104Z	B	10.1/103
C1968	4030018960	S.CER C3216 JB 1C 106MT-N	B	31.7/103.6
C1969	4030018970	S.CER C3225 JB 1C 226MT-N	B	30.8/100.9
C1970	4030018970	S.CER C3225 JB 1C 226MT-N	B	30.8/97.9
C1971	4030017330	S.CER ECJ0EF1C104Z	B	45.9/111.3
C1972	4030017330	S.CER ECJ0EF1C104Z	B	47.6/106.7
C1973	4030017330	S.CER ECJ0EF1C104Z	B	32.1/105.1
C2001	4030017780	S.CER ECJ0EB1E472K	T	33.2/10.3
C2002	4030017330	S.CER ECJ0EF1C104Z	B	71.7/14.6
C2003	4030017780	S.CER ECJ0EB1E472K	B	58.8/15.8
C2004	4030017780	S.CER ECJ0EB1E472K	B	83/5.9
C2005	4030017780	S.CER ECJ0EB1E472K	B	69/16.4
C2006	4030017330	S.CER ECJ0EF1C104Z	B	83/6.8
C2007	4030017780	S.CER ECJ0EB1E472K	B	84.6/5.9
C2008	4030017330	S.CER ECJ0EF1C104Z	B	56.7/10.1
C2009	4030017330	S.CER ECJ0EF1C104Z	B	75.4/18.6
C2010	4030017780	S.CER ECJ0EB1E472K	B	75.6/6.6

M.=Mounted side (T: Mounted on the Top side, B: Mounted on the Bottom side)
S.=Surface mount

[MAIN UNIT]

REF NO.	PARTS NO.	DESCRIPTION	M.	H/V LOCATION
C2011	4030017330	S.CER ECJ0EF1C104Z	B	75/7.7
C2012	4030017780	S.CER ECJ0EB1E472K	B	63.1/15.5
C2013	4030017330	S.CER ECJ0EF1C104Z	B	88.9/2
C2014	4030017780	S.CER ECJ0EB1E472K	B	32.5/11.8
C2015	4030017780	S.CER ECJ0EB1E472K	B	32.5/12.7
C2016	4030017780	S.CER ECJ0EB1E472K	B	19/131.2
C2017	4030017330	S.CER ECJ0EF1C104Z	T	86.4/10.2
C2018	4030017780	S.CER ECJ0EB1E472K	B	42.7/17.7
C2019	4030017780	S.CER ECJ0EB1E472K	T	24.7/126.7
C2020	4030017330	S.CER ECJ0EF1C104Z	B	84.1/23.1
C2021	4030017780	S.CER ECJ0EB1E472K	B	32.5/16
C2022	4030017780	S.CER ECJ0EB1E472K	B	30.3/130.2
C2024	4030017780	S.CER ECJ0EB1E472K	B	28.7/128.2
C2025	4030017780	S.CER ECJ0EB1E472K	B	45/12.5
C2026	4030018960	S.CER C3216 JB 1C 106MT-N	B	10.1/23.4
C2027	4030018960	S.CER C3216 JB 1C 106MT-N	B	10.1/14.6
C2028	4030017330	S.CER ECJ0EF1C104Z	B	51.7/12.7
C2029	4030017330	S.CER ECJ0EF1C104Z	B	58.1/9.4
C2030	4030017330	S.CER ECJ0EF1C104Z	B	55.8/15.8
C2032	4030017780	S.CER ECJ0EB1E472K	B	27.4/129
C2033	4030017330	S.CER ECJ0EF1C104Z	B	71.1/21.9
C2034	4030017780	S.CER ECJ0EB1E472K	B	64.8/5.6
C2035	4030017780	S.CER ECJ0EB1E472K	B	25.6/130.2
C2036	4030017330	S.CER ECJ0EF1C104Z	B	88.2/8
C2037	4030017330	S.CER ECJ0EF1C104Z	B	76.4/16.5
C2038	4030017780	S.CER ECJ0EB1E472K	T	14.5/126.4
C2039	4030017780	S.CER ECJ0EB1E472K	B	80.2/6.7
C2040	4030017780	S.CER ECJ0EB1E472K	B	64.6/17.7
C2041	4030017330	S.CER ECJ0EF1C104Z	B	75.2/10.5
C2042	4030017330	S.CER ECJ0EF1C104Z	B	62.7/18.1
C2043	4030017780	S.CER ECJ0EB1E472K	B	55.4/8.8
C2044	4030017780	S.CER ECJ0EB1E472K	B	62.7/19.5
C2045	4030017780	S.CER ECJ0EB1E472K	B	64.3/21.8
C2046	4030017780	S.CER ECJ0EB1E472K	B	62.6/14.6
C2047	4030017780	S.CER ECJ0EB1E472K	B	57.7/21.9
C2048	4030017780	S.CER ECJ0EB1E472K	B	63.1/5.6
C2049	4030017780	S.CER ECJ0EB1E472K	T	45.1/101.8
C2050	4030017780	S.CER ECJ0EB1E472K	T	42.8/100.3
C2051	4030017330	S.CER ECJ0EF1C104Z	T	56.3/99.9
C2052	4030017780	S.CER ECJ0EB1E472K	T	21.6/108
C2053	4030017780	S.CER ECJ0EB1E472K	T	49.8/107.5
C2054	4030018960	S.CER C3216 JB 1C 106MT-N	B	55.3/83.4
C2055	4030018960	S.CER C3216 JB 1C 106MT-N	B	28.1/88.5
C2058	4030018960	S.CER C3216 JB 1C 106MT-N	B	16.4/95.5
C2062	4550007710	S.TAN TEESVBZ 1A 476M8R	B	26.6/13
C2063	4030017730	S.CER ECJ0EB1E471K	B	46/13.7
C2064	4030018960	S.CER C3216 JB 1C 106MT-N	B	61.1/23
C2065	4030016930	S.CER ECJ0EB1A104K	B	73.3/1.2
C2066	4030016930	S.CER ECJ0EB1A104K	B	75.1/1.2
C2067	4030017430	S.CER ECJ0EC1H101J	B	56.9/19.9
C2068	4030017460	S.CER ECJ0EB1E102K	B	59.1/26.1
C2069	4030017730	S.CER ECJ0EB1E471K	B	46.6/12.1
C2101	4030017330	S.CER ECJ0EF1C104Z	T	28.3/113.8
C2102	4030017330	S.CER ECJ0EF1C104Z	T	44.7/110.9
C2103	4030018960	S.CER C3216 JB 1C 106MT-N	T	28.8/112.2
C2104	4030017330	S.CER ECJ0EF1C104Z	T	56.1/123.5
C2105	4030018960	S.CER C3216 JB 1C 106MT-N	T	54.7/125
C2156	4030017330	S.CER ECJ0EF1C104Z	T	36.2/122.1
C2157	4030017330	S.CER ECJ0EF1C104Z	B	34.4/91
C2158	4030017330	S.CER ECJ0EF1C104Z	B	27.4/93.7
C2159	4030017330	S.CER ECJ0EF1C104Z	T	22.4/94.4
C2160	4030017330	S.CER ECJ0EF1C104Z	B	38.2/88.8
C2161	4030018960	S.CER C3216 JB 1C 106MT-N	T	36.8/123.6
C2162	4030018960	S.CER C3216 JB 1C 106MT-N	B	37.7/90.4
C2163	4030017780	S.CER ECJ0EB1E472K	T	4.6/116.5
C2164	4030018960	S.CER C3216 JB 1C 106MT-N	T	6.5/114.9
C2166	4030012610	S.CER C2012 JB 1C 474K-T	T	5.2/106.8
C2167	4030018960	S.CER C3216 JB 1C 106MT-N	T	4.9/109.9
C2168	4030012610	S.CER C2012 JB 1C 474K-T	T	16.5/116.8
C2169	4030016930	S.CER ECJ0EB1A104K	T	14/124.2
C2201	4030017780	S.CER ECJ0EB1E472K	T	24.7/125.8
C2203	4030018520	S.CER C1608 JB 0J 225M-T	T	16/118.4
C2204	4030017330	S.CER ECJ0EF1C104Z	T	11.1/119.7
C2205	4030018960	S.CER C3216 JB 1C 106MT-N	T	12.4/117.1
C2206	4030017780	S.CER ECJ0EB1E472K	T	21.7/115.6
C2208	4030017730	S.CER ECJ0EB1E471K	T	19/116.9
C2211	4030018960	S.CER C3216 JB 1C 106MT-N	T	22.4/119.9
C2212	4030018960	S.CER C3216 JB 1C 106MT-N	T	23.2/124.3
C2213	4550007140	S.TAN TEESVD 1C 107M12R	T	37.6/138.5
C2214	4030018910	S.CER C1608 JB 0J 475K-T	T	20.9/122.6
C2231	4030017330	S.CER ECJ0EF1C104Z	T	38.2/105.6
C2232	4030018960	S.CER C3216 JB 1C 106MT-N	T	38.1/104
C2233	4030017780	S.CER ECJ0EB1E472K	T	4.7/123.2
C2234	4550007310	S.TAN F930J227MNMBA	T	70.1/130.6
C2235	4030018960	S.CER C3216 JB 1C 106MT-N	T	40.9/108.8
C2236	4030018960	S.CER C3216 JB 1C 106MT-N	T	39.8/111.1
C2237	4030017460	S.CER ECJ0EB1E102K	T	60.6/123.3
C2254	4030017330	S.CER ECJ0EF1C104Z	T	7.6/92.5
C2255	4030017330	S.CER ECJ0EF1C104Z	B	2.4/98.1
C2256	4030017330	S.CER ECJ0EF1C104Z	B	2.6/95.6
C2257	4030017330	S.CER ECJ0EF1C104Z	T	9.9/87.9
C2260	4030017330	S.CER ECJ0EF1C104Z	T	18.5/103.6
C2261	4030017330	S.CER ECJ0EF1C104Z	T	6.7/104.4
C2262	4030017330	S.CER ECJ0EF1C104Z	T	58.5/100.3
C2264	4030017330	S.CER ECJ0EF1C104Z	T	61.8/88.9
C2266	4030017330	S.CER ECJ0EF1C104Z	T	72/85.2
C2268	4030017330	S.CER ECJ0EF1C104Z	T	68.5/89.4

[MAIN UNIT]

REF NO.	PARTS NO.	DESCRIPTION	M.	H/V LOCATION
C2269	4030017330	S.CER ECJ0EF1C104Z	B	78.4/92.4
C2270	4030017780	S.CER ECJ0EB1E472K	T	61.8/89.8
C2272	4030017330	S.CER ECJ0EF1C104Z	T	56.2/92.2
C2274	4030017330	S.CER ECJ0EF1C104Z	T	55.8/95
C2275	4030017330	S.CER ECJ0EF1C104Z	B	68.1/99.3
C2276	4030017330	S.CER ECJ0EF1C104Z	B	64.2/100.6
C2277	4030017330	S.CER ECJ0EF1C104Z	T	63.6/103.4
C2278	4030017330	S.CER ECJ0EF1C104Z	T	63.6/107.9
C2279	4030017330	S.CER ECJ0EF1C104Z	T	62.7/108.8
C2280	4030017420	S.CER ECJ0EC1H470J	T	51.8/37.9
C2281	4030017330	S.CER ECJ0EF1C104Z	T	68.5/90.3
C2282	4030017330	S.CER ECJ0EF1C104Z	B	80.4/93
C2283	4030017330	S.CER ECJ0EF1C104Z	B	81.6/92.1
C2285	4030017330	S.CER ECJ0EF1C104Z	T	50.8/99.9
C2286	4030017330	S.CER ECJ0EF1C104Z	T	14.1/88.8
C2301	4030018910	S.CER C1608 JB 0J 475K-T	T	30.8/106.9
C2302	4030018910	S.CER C1608 JB 0J 475K-T	T	27.8/109.4
C2303	4550007310	S.TAN F930J227MNMBA	B	84.4/110.3
C2311	4030017330	S.CER ECJ0EF1C104Z	B	68.1/110.2
C2312	4030018910	S.CER C1608 JB 0J 475K-T	B	67.3/104.9
C2401	4030017330	S.CER ECJ0EF1C104Z	B	90.8/103.8
C2402	4030017330	S.CER ECJ0EF1C104Z	B	81.2/100.7
C2403	4030017780	S.CER ECJ0EB1E472K	B	77.2/28.8
C2405	4030017330	S.CER ECJ0EF1C104Z	T	74.2/79.3
C2406	4030017460	S.CER ECJ0EB1E102K	B	88.5/99.7
C2407	4030017330	S.CER ECJ0EF1C104Z	T	74.1/78.2
C2408	4030017330	S.CER ECJ0EF1C104Z	B	84.9/96.1
C2409	4030017330	S.CER ECJ0EF1C104Z	T	75.6/77.6
C2410	4030017330	S.CER ECJ0EF1C104Z	B	88.5/85.8
C2411	4030017330	S.CER ECJ0EF1C104Z	B	81.1/96.4
C2412	4510008630	S.ELE 16 CE 47 FE	B	62.1/30.4
C2413	4030017330	S.CER ECJ0EF1C104Z	B	88.5/93.7
C2414	4030017780	S.CER ECJ0EB1E472K	B	84/95.6
C2415	4030017780	S.CER ECJ0EB1E472K	B	88.3/28
C2417	4030017330	S.CER ECJ0EF1C104Z	B	88.3/27.1
C2418	4030017330	S.CER ECJ0EF1C104Z	B	82.6/94
C2419	4030017330	S.CER ECJ0EF1C104Z	B	88.5/86.7
C2422	4030017330	S.CER ECJ0EF1C104Z	T	84.8/87.3
C2423	4030017420	S.CER ECJ0EC1H470J	B	62.1/141.2
C2424	4510008630	S.ELE 16 CE 47 FE	B	69.2/31.3
C2426	4030017330	S.CER ECJ0EF1C104Z	B	68.8/82.1
C2427	4030012600	S.CER C2012 JB 1A 105M-T	T	85.1/91.4
C2501	4030017330	S.CER ECJ0EF1C104Z	B	8/94.2
C2502	4030018960	S.CER C3216 JB 1C 106MT-N	B	11.5/95.2
C2503	4030016970	S.CER ECJ0EB1C223K	B	14.9/89.3
C2505	4030016940	S.CER ECJ0EB1A393K	B	17.4/91.4
C2506	4030017780	S.CER ECJ0EB1E472K	B	18.2/93.8
C2507	4030017490	S.CER C1608 JB 1A 105K-T	B	12.7/89.2
C2551	4030017330	S.CER ECJ0EF1C104Z	B	42.9/124.1
C2552	4030018960	S.CER C3216 JB 1C 106MT-N	B	47.8/118.8
C2553	4030016970	S.CER ECJ0EB1C223K	B	51.3/124.7
C2554	4030018390	S.CER ECJ0EB1A563K	B	53.9/121.9
C2555	4030017760	S.CER ECJ0EB1H222K	B	53.9/121
C2556	4030017770	S.CER ECJ0EB1E332K	B	52.8/123.8
C2557	4030017330	S.CER ECJ0EF1C104Z	B	41.7/120.8
C2558	4030018960	S.CER C3216 JB 1C 106MT-N	B	42.9/118.4
C2561	4030018960	S.CER C3216 JB 1C 106MT-N	B	56.5/124.3
C2562	4030018960	S.CER C3216 JB 1C 106MT-N	B	53.4/126.4
C2563	4550007110	S.TAN SY6-1A107M-RC	B	75.3/122.8
C2564	4030018080	S.CER ECJ0EB1H182K	B	47.8/125.6
C2565	4030017430	S.CER ECJ0EC1H101J	B	44.6/122.6
C2566	4030018090	S.CER ECJ0EB1C822K	B	46.2/124.3
C2601	4030017330	S.CER ECJ0EF1C104Z	B	59.7/125.1
C2603	4030010210	S.CER C3216 JB 1C 105M-T	B	87.5/126
C2604	4030016970	S.CER ECJ0EB1C223K	B	89.1/128.6
C2605	4030017330	S.CER ECJ0EF1C104Z	B	83.9/133.7
C2606	4510009250	S.ELE EEEFK1C471P	T	69.2/137.4
C2607	4510008650	S.ELE EEEFK1C221P	T	58.5/138.3
C2608	4030017330	S.CER ECJ0EF1C104Z	B	87.5/128.6
C2610	4510009250	S.ELE EEEFK1C471P	T	6.2/65.3
C2612	4030017330	S.CER ECJ0EF1C104Z	B	33.9/123.9
C2613	4510009250	S.ELE EEEFK1C471P	T	31.7/131.5
C2616	4030017780	S.CER ECJ0EB1E472K	B	31.6/134.3
C2617	4030017780	S.CER ECJ0EB1E472K	T	33.5/126
C2618	4030017430	S.CER ECJ0EC1H101J	B	31.6/133.4
C2619	4030017780	S.CER ECJ0EB1E472K	T	67.7/112.6
C2620	4510008630	S.ELE 16 CE 47 FE	B	82.9/119.1
C2621	4510008500	S.ELE EEE1CA101WP	T	49.2/138.3
C2622	4510008500	S.ELE EEE1CA101WP	T	60.1/130.4
C2624	4030017330	S.CER ECJ0EF1C104Z	B	38.4/124.5
CP1601	6910009670	S.CHE HK3-S-T	T	11.7/54.7
J1	6510007020	CON TMP-J01X-V6		
J101	6510007020	CON TMP-J01X-V6		
J401	6510007020	CON TMP-J01X-V6		
J801	6510007020	CON TMP-J01X-V6		
J2002	6510019971	S.CON 52808-1071	T	39/12.6
J2003	6510024861	S.CON 5406721-2	T	18.7/137.8
J2004	65			

[MAIN UNIT]

REF NO.	PARTS NO.	DESCRIPTION	M.	H/V LOCATION
J2402	6510025770	S.CON 03-935H0-72BKA	B	47/136.6
J2403	6510019371	S.CON B3B-ZR-SM4-TF(LF)(SN)	T	94.8/1.8
J2405	6510024880	S.CON 52689-3087	T	90.3/93.8
J2406	6510024880	S.CON 52689-3087	T	90.3/70.9
J2407	6510025770	S.CON 03-935H0-72BKA	B	68.4/136.6
J2601	6510014961	S.CON B2B-ZR-SM4-TF(LF)(SN)	T	42.6/128.8
J2602	6510025770	S.CON 03-935H0-72BKA	B	36.3/136.6
W1	9029701008	WIR 72/98/020/X98/X98		
W601	9029701008	WIR 72/98/020/X98/X98		
EP104	6910012350	S.BEA MMZ1608Y 102BT	T	61.2/28.2
EP511	6910012350	S.BEA MMZ1608Y 102BT	T	44.1/26.5
EP1951	6910014730	S.BEA MPZ2012S331A-T	B	61.3/116.7
EP1952	6910014730	S.BEA MPZ2012S331A-T	B	26.8/113.3
EP1953	6910014730	S.BEA MPZ2012S331A-T	B	9.9/104.5
EP1954	6910014730	S.BEA MPZ2012S331A-T	B	50.3/107.3
EP2001	6910012350	S.BEA MMZ1608Y 102BT	B	74.2/5.3
EP2002	6910012350	S.BEA MMZ1608Y 102BT	B	34.7/12.6
EP2003	6910012350	S.BEA MMZ1608Y 102BT	B	33.5/13.8
EP2004	6910012350	S.BEA MMZ1608Y 102BT	B	39.5/15.9
EP2006	6910014730	S.BEA MPZ2012S331A-T	B	42.2/13.3
EP2007	6910012350	S.BEA MMZ1608Y 102BT	B	45.2/11
EP2008	6910012350	S.BEA MMZ1608Y 102BT	B	45.1/14.8
EP2231	6910012350	S.BEA MMZ1608Y 102BT	T	59.8/125.7
EP2251	6910012350	S.BEA MMZ1608Y 102BT	T	4.5/95.5
EP2252	6910012350	S.BEA MMZ1608Y 102BT	T	7.5/95.8
EP2253	6910012350	S.BEA MMZ1608Y 102BT	T	66.1/109.3
EP2254	6910012350	S.BEA MMZ1608Y 102BT	T	65.7/108.1
EP2255	6910012350	S.BEA MMZ1608Y 102BT	T	17.8/101.5
EP2256	6910012350	S.BEA MMZ1608Y 102BT	T	65.1/106
EP2257	6910012350	S.BEA MMZ1608Y 102BT	T	65.1/104.8
EP2258	6910012350	S.BEA MMZ1608Y 102BT	B	77.9/93.4
EP2259	6910012350	S.BEA MMZ1608Y 102BT	B	68.1/102.5
EP2260	6910012350	S.BEA MMZ1608Y 102BT	B	68.1/101.3
EP2261	6910012350	S.BEA MMZ1608Y 102BT	B	66/98.2
EP2262	6910012350	S.BEA MMZ1608Y 102BT	T	69.9/85.5
EP2263	6910014730	S.BEA MPZ2012S331A-T	T	6.5/93.9
EP2264	6910012350	S.BEA MMZ1608Y 102BT	B	69.3/111.3
EP2265	6910012350	S.BEA MMZ1608Y 102BT	B	68.6/98.2
EP2266	6910012350	S.BEA MMZ1608Y 102BT	T	56.2/93.3
EP2271	6910012350	S.BEA MMZ1608Y 102BT	T	74.6/91.1
EP2402	6910012350	S.BEA MMZ1608Y 102BT	B	51.1/129.6
EP2403	6910012350	S.BEA MMZ1608Y 102BT	B	48.4/129.6
EP2404	6910012350	S.BEA MMZ1608Y 102BT	B	68.5/129.3
EP2405	6910012350	S.BEA MMZ1608Y 102BT	B	62.1/134.9
EP2408	6910012350	S.BEA MMZ1608Y 102BT	B	91.3/102.7
EP2409	6910012350	S.BEA MMZ1608Y 102BT	T	85.3/101.2
EP2410	6910012350	S.BEA MMZ1608Y 102BT	T	84.7/98.3
EP2411	6910012350	S.BEA MMZ1608Y 102BT	T	85.2/79.2
EP2412	6910012350	S.BEA MMZ1608Y 102BT	T	82.5/78.4
EP2413	6910012350	S.BEA MMZ1608Y 102BT	B	72.4/129.3
EP2414	6910012350	S.BEA MMZ1608Y 102BT	B	89.3/91
EP2415	6910012350	S.BEA MMZ1608Y 102BT	T	84.9/100
EP2416	6910012350	S.BEA MMZ1608Y 102BT	T	80/77.6
EP2417	6910012350	S.BEA MMZ1608Y 102BT	B	87.2/78.8
EP2602	6910014730	S.BEA MPZ2012S331A-T	T	35.9/125.6
EP2604	6910014730	S.BEA MPZ2012S331A-T	B	31.6/135.7
EP2605	6910014730	S.BEA MPZ2012S331A-T	T	42.9/135.4
EP2606	6910014730	S.BEA MPZ2012S331A-T	T	41.3/133.7
MP201	8510017210	PLA 2427 B-SHIELD PLATE Y801	B	23.1/59.8

[PA UNIT]

REF NO.	PARTS NO.	DESCRIPTION	M.	H/V LOCATION
IC471	1110005630	S.IC UPC3215TB-E3-A	B	67.6/96.4
IC701	1180002010	S.REG BA08FP-E2	B	126.3/41.9
IC960	1110002700	S.IC NJM2904M-TE1-#FMZB	B	41/132.1
IC981	1130012720	S.IC CD74HC4094PWR	T	26.2/5.9
Q101	1560001091	S.FET 2SK2854(T2LICOM,F)	T	149.2/28.5
Q102	1560001241	S.FET RD01MUS1-T113	T	146/40.1
Q301	1560001391	FET RD70HHF1-101		
Q302	1560001391	FET RD70HHF1-101		
Q401	1560001401	FET RD60HUF1-101		
Q402	1590000680	S.TRA DTC114EUA T106	B	87.7/132.8
Q403	1590000680	S.TRA DTC114EUA T106	B	90/130.3
Q451	1580000691	S.FET 3SK291 (E85R,F)	B	76.7/108.3
Q452	1590003940	S.TRA RN1105(TE85L,F)	B	67.5/115.8
Q453	1590003940	S.TRA RN1105(TE85L,F)	B	75.1/119.8
Q501	1560001591	FET RD70HVF1C-121		
Q502	1590000680	S.TRA DTC114EUA T106	T	87.7/107.5
Q503	1590000680	S.TRA DTC114EUA T106	T	87.7/110
Q551	1580000691	S.FET 3SK291 (E85R,F)	T	68.4/108.9
Q552	1590003940	S.TRA RN1105(TE85L,F)	T	63/110.1
Q700	1590003940	S.TRA RN1105(TE85L,F)	B	126.4/25
Q741	1590003940	S.TRA RN1105(TE85L,F)	B	79.4/9
Q742	1520000460	S.TRA 2SB1132 T100 R	B	83.6/8.2
Q980	1590003940	S.TRA RN1105(TE85L,F)	T	51.3/84.2
Q981	1590003940	S.TRA RN1105(TE85L,F)	T	51.5/87.3
Q982	1590003940	S.TRA RN1105(TE85L,F)	T	53.8/97.3
Q983	1590003940	S.TRA RN1105(TE85L,F)	T	51.2/56.9
Q984	1590003940	S.TRA RN1105(TE85L,F)	T	51.6/97.2
Q985	1590003940	S.TRA RN1105(TE85L,F)	T	51.3/27.9
Q986	1590003940	S.TRA RN1105(TE85L,F)	T	51.3/71.4
Q987	1590003940	S.TRA RN1105(TE85L,F)	T	52.5/41.6
Q988	1590003930	S.TRA UMD22N TR	T	58.2/90.2
D101	1750000301	S.DIO 1SS302(E85R,F)	T	152.4/22.7
D102	1750000301	S.DIO 1SS302(E85R,F)	T	152.4/19.8
D151	1750000581	S.DIO 1SV307(TPH3,F)	T	59.5/56.4
D152	1790001250	S.DIO MA2S111-(TX)	T	56.3/58.5
D301	1160000060	S.DIO DAN202U T106	T	105.1/80.8
D302	1160000060	S.DIO DAN202U T106	T	74.9/87.3
D401	1790001240	S.DIO MA2S728-(TX)	B	128/133.6
D402	1790001240	S.DIO MA2S728-(TX)	B	127.5/139.5
D403	1790001240	S.DIO MA2S728-(TX)	B	123.4/140.5
D404	1790001240	S.DIO MA2S728-(TX)	B	125.6/132.8
D406	1710001061	DIO L407CDB		
D407	1710001061	DIO L407CDB		
D408	1750000511	S.DIO UX9401F-STD/TR	B	97.7/136.4
D409	1750000511	S.DIO UX9401F-STD/TR	B	103.5/133
D410	1750000511	S.DIO UX9401F-STD/TR	B	104.7/130
D411	1790001250	S.DIO MA2S111-(TX)	B	94.2/129.2
D412	1160000070	S.DIO DAN202K T146	B	91.6/127
D451	1750000581	S.DIO 1SV307(TPH3,F)	B	85.5/116.3
D452	1750000581	S.DIO 1SV307(TPH3,F)	B	82.4/116
D453	1720000701	S.VAR 1SV305(TPL3,F)	T	75.5/117.3
D454	1720000701	S.VAR 1SV305(TPL3,F)	T	77.8/116.6
D455	1720000701	S.VAR 1SV305(TPL3,F)	B	75.6/99.1
D456	1720000701	S.VAR 1SV305(TPL3,F)	B	67.3/104.1
D461	1750000581	S.DIO 1SV307(TPH3,F)	B	65/93.5
D462	1750000581	S.DIO 1SV307(TPH3,F)	T	65.6/94.7
D501	1790000970	S.DIO MA729(TX)	B	113.7/123.4
D502	1790000970	S.DIO MA729(TX)	B	116.3/122.8
D503	1790000970	S.DIO MA729(TX)	B	114.5/129.4
D504	1790000970	S.DIO MA729(TX)	B	111/129.4
D506	1710001061	DIO L407CDB		
D507	1750000511	S.DIO UX9401F-STD/TR	B	92.1/117.4
D508	1750000511	S.DIO UX9401F-STD/TR	T	86.9/114.4
D509	1750000511	S.DIO UX9401F-STD/TR	T	81.9/120.3
D510	1710001061	DIO L407CDB		
D511	1750000581	S.DIO 1SV307(TPH3,F)	B	95.3/112.2
D551	1750000581	S.DIO 1SV307(TPH3,F)	T	74/116.7
D552	1750000581	S.DIO 1SV307(TPH3,F)	T	72.2/116.7
D553	1750000610	S.VAR MA2SV0500L	T	67.2/118.5
D554	1750000610	S.VAR MA2SV0500L	T	69.6/117.8
D555	1750000581	S.DIO 1SV307(TPH3,F)	T	66.9/116.7
D556	1720000590	S.VAR MA357(TX)	T	71.6/113.3
D557	1750000581	S.DIO 1SV307(TPH3,F)	T	68.1/104.9
D558	1720000590	S.VAR MA357(TX)	T	72.2/104.3
D559	1750000610	S.VAR MA2SV0500L	T	68.9/102.7
D560	1750000610	S.VAR MA2SV0500L	T	71.7/101.3
D701	1790000700	DIO DSA3A1		
D702	1790000700	DIO DSA3A1		
D703	1160000070	S.DIO DAN202K T146	B	126.5/21.5
D704	1790001240	S.DIO MA2S728-(TX)	B	87.9/113.9
D705	1160000070	S.DIO DAN202K T146	B	137.5/14.2
D706	1790001240	S.DIO MA2S728-(TX)	B	86/113
D801	1750000301	S.DIO 1SS302(E85R,F)	B	42.7/41.8
D820	1750000301	S.DIO 1SS302(E85R,F)	B	54.3/94.5
D840	1750000301	S.DIO 1SS302(E85R,F)	B	43.3/99.8
D860	1750000301	S.DIO 1SS302(E85R,F)	B	43/86
D880	1750000301	S.DIO 1SS302(E85R,F)	B	43.3/71.6
D900	1750000301	S.DIO 1SS302(E85R,F)	B	43.7/56.9
D920	1750000301	S.DIO 1SS302(E85R,F)	B	42.9/28
D940	1750000301	S.DIO 1SS302(E85R,F)	B	41.1/14.2
D961	1790000491	S.DIO HSM88ASTR-E	B	28.1/130.2
D962	1790000491	S.DIO HSM88ASTR-E	B	28.1/133.7
D964	1750000511	S.DIO UX9401F-STD/TR	B	40.1/43.9

M.=Mounted side (T: Mounted on the Top side, B: Mounted on the Bottom side)
S.=Surface mount

[PA UNIT]

REF NO.	PARTS NO.	DESCRIPTION	M.	H/V LOCATION
D965	1750000511	S.DIO UX9401F-STD/TR	B	42.8/48
L101	6200005051	S.COI NLV25T-330J	T	151.3/33.6
L102	6200008570	S.COI LQW2BHN6N8D03L	T	152.3/37.3
L103	6180000990	COI LAL 04NA 101K		
L104	6180000990	COI LAL 04NA 101K		
L105	6200003950	S.COI HF50ACC 322513-T	B	135.7/34.1
L107	6200002631	S.COI NLV25T-R10J	T	141/47.9
L108	6200003031	S.COI NLV32T-R47J	B	138/41.7
L151	6200003941	S.COI NLV25T-5R6J	B	64.1/41
L152	6200005521	S.COI NLV25T-470J	B	64.8/38
L201	6140004580	S.COI LR-515	T	150.4/52.5
L203	6200010040	S.COI AS100340-10N	T	113.8/79.5
L204	6200010040	S.COI AS100340-10N	T	123.5/69.7
L301	6140003410	COI LR-383		
L302	2040000490	COI EXC-ELDR25C		
L303	6140003590	COI LR-400 (TR10X5X5 6H3)		
L304	6140004570	COI LR-507		
L305	6140004560	COI LR-506		
L404	6200010060	S.COI AS080647-56N	T	141/108.9
L407	6200010170	S.COI AS080447-33N	T	146.6/110.7
L408	2040000490	COI EXC-ELDR25C		
L409	2040000490	COI EXC-ELDR25C		
L410	6200010040	S.COI AS100340-10N	T	126.5/137.8
L411	6200010420	S.COI FHW1210HC 1R0JGT <JJE>	T	118.3/136.7
L412	6200010160	S.COI AS080440-22N	T	104.4/134.4
L413	6200010150	S.COI AS080340-15N	T	88.2/139.5
L414	6200010150	S.COI AS080340-15N	T	81/133.5
L415	6200012960	S.COI 0.45-1.4-4TL 12.1N <COMO>	T	99.2/134
L416	6200013000	S.COI 0.25-1.9-13TL 135N <COMO>	T	93.8/132.1
L417	6200007790	S.COI LQW2BHN15J03L	B	98.3/131.1
L441	6200010040	S.COI AS100340-10N	T	133.4/137.8
L451	6200005621	S.COI ELJRE 4N7ZFA	B	81.5/120.1
L452	6200012660	S.COI 0.30-1.0-4TR 9.1N <COMO>	T	76.7/114.9
L453	6200007230	S.COI LQW2BHN15N03L	B	74/104
L454	6200007230	S.COI LQW2BHN15N03L	B	69.9/102.3
L501	6200010780	S.COI C2520C-1R0G-A	T	117.1/86.6
L502	6200010060	S.COI AS080647-56N	T	118.1/125
L504	6200010780	S.COI C2520C-1R0G-A	T	105.7/123.4
L505	6200010070	S.COI AS080747-68N	T	90.2/118.5
L506	6200010170	S.COI AS080447-33N	T	91.9/124.3
L507	6200012910	S.COI 0.35-1.6-8TL 45.5N <COMO>	T	84.7/118
L508	6200010050	S.COI AS080547-47N	T	81.8/127.7
L509	6200010780	S.COI C2520C-1R0G-A	T	93.2/113.1
L510	6200010050	S.COI AS080547-47N	T	75.5/127.5
L531	6110003980	COI LA-604		
L541	6200010070	S.COI AS080747-68N	T	128.5/129.8
L551	6200007700	S.COI LQW2BHN22N03L	T	76.1/120.8
L552	6200007720	S.COI LQW2BHN33N03L	T	70.8/121.2
L553	6200008090	S.COI LQW2BHN68N03L	T	65.1/121.6
L554	6200003640	S.COI MLF1608E 100K-T	T	64.9/114.8
L555	6200003711	S.COI NLV25T-2R7J	T	65.2/105.4
L556	6200003640	S.COI MLF1608E 100K-T	B	64.9/109.6
L557	6200007760	S.COI LQW2BHN82N03L	T	66.8/100.5
L558	6200007710	S.COI LQW2BHN27N03L	T	69.9/98.3
L560	6200002611	S.COI NLV25T-R47J	T	62.9/97.3
L601	6200010040	S.COI AS100340-10N	T	69.2/127.5
L602	6200010160	S.COI AS080440-22N	T	65.7/132.8
L603	6200010150	S.COI AS080340-15N	T	60.8/133.5
L705	6200003550	S.COI MLF1608A 4R7K-T	B	68.2/10.3
L706	6200011300	S.COI EXCML16A270U	T	91/6.9
L707	6200011300	S.COI EXCML16A270U	T	91/5.6
L801	6200011410	S.COI C2520C-82NG-A	T	55.8/55.5
L802	6200010650	S.COI C2520C-1R12G-A (0.12U)	T	58.5/52.1
L803	6200007420	S.COI ELJFC 101K-F	B	50.4/39.8
L820	6200006430	S.COI ELJFC 180K-F	B	52.8/97.3
L821	6140002020	COI LR-229 (T50-10)		
L822	6140003540	COI LR-396		
L823	6200006430	S.COI ELJFC 180K-F	B	2.7/106.8
L840	6200007420	S.COI ELJFC 101K-F	B	49.2/98.5
L841	6140001820	COI LR-218 (T50-10)		
L842	6140001800	COI LR-216 (T50-2)		
L843	6140001800	COI LR-216 (T50-2)		
L844	6200007420	S.COI ELJFC 101K-F	B	2.6/90.7
L860	6200004440	S.COI ELJFC 4R7M-F	B	50.3/83.8
L861	6110003550	COI LA-547 (LA-214A)		
L862	6110003570	COI LA-550		
L863	6110003540	COI LA-548 (LA-215A)		
L864	6200004440	S.COI ELJFC 4R7M-F	B	2.8/74.5
L880	6200007420	S.COI ELJFC 101K-F	B	50.3/69.1
L881	6140002570	COI LR-294 (T50-2)		
L882	6140002580	COI LR-295 (T50-2)		
L883	6200007420	S.COI ELJFC 101K-F	B	2.6/58.4
L900	6200008600	S.COI ELJFC 560K-F	B	50/54.6
L901	6140002560	COI LR-293 (T50-10)		
L902	6140002560	COI LR-293 (T50-10)		
L903	6140002560	COI LR-293 (T50-10)		
L904	6200008600	S.COI ELJFC 560K-F	B	2.6/42.3
L920	6200007420	S.COI ELJFC 101K-F	B	50.4/25.4
L921	6140001780	COI LR-214 (T50-2)		
L922	6140001780	COI LR-214 (T50-2)		
L923	6200007420	S.COI ELJFC 101K-F	B	2.6/26.1
L940	6200007390	S.COI ELJFC 120K-F	B	47.3/9.9
L941	6140003450	COI LR-387 (T50-10)		
L942	6140003460	COI LR-388 (T50-10)		
L943	6200007420	S.COI ELJFC 101K-F	B	41.1/11.1

[PA UNIT]

REF NO.	PARTS NO.	DESCRIPTION	M.	H/V LOCATION
L944	6200007390	S.COI ELJFC 120K-F	B	9/10.5
L960	6200007420	S.COI ELJFC 101K-F	B	45.3/130.6
L961	6140003490	COI LR-391 (TR10X5X5 3A6)		
L980	6200007420	S.COI ELJFC 101K-F	B	30.7/8
L981	6200007420	S.COI ELJFC 101K-F	T	51.7/9
L982	6200007420	S.COI ELJFC 101K-F	T	48.3/2.3
R101	7030003370	S.RES ERJ3GEYJ 271 V (270)	B	150.9/21
R102	7030003230	S.RES ERJ3GEYJ 180 V (18)	B	150.9/22.5
R103	7030003370	S.RES ERJ3GEYJ 271 V (270)	B	151.9/25.2
R104	7030003300	S.RES ERJ3GEYJ 680 V (68)	B	150.8/27.7
R105	7030003420	S.RES ERJ3GEYJ 681 V (680)	T	152.7/29.8
R106	7030003480	S.RES ERJ3GEYJ 222 V (2.2K)	B	147.8/29.7
R107	7030003530	S.RES ERJ3GEYJ 562 V (5.6K)	B	147.8/28.3
R108	7030003400	S.RES ERJ3GEYJ 471 V (470)	T	145.4/31.7
R109	7030008190	S.RES ERJ12YJ330U (33)	B	151.5/32.7
R110	7030000230	S.RES MCR10EZJH 56 (560)	T	149.4/39.8
R111	7030003410	S.RES ERJ3GEYJ 561 V (560)	B	143.8/42.1
R112	7030003510	S.RES ERJ3GEYJ 392 V (3.9K)	B	146.1/37.5
R113	7030003540	S.RES ERJ3GEYJ 682 V (6.8K)	B	146.1/35.7
R116	7030000340	S.RES MCR10EZJH 470 (471)	B	141.3/40.8
R117	7030003860	S.RES ERJ3GE JPW V	T	146.7/47.7
R151	7030003380	S.RES ERJ3GEYJ 331 V (330)	B	61.6/37.8
R152	7030003440	S.RES ERJ3GEYJ 102 V (1K)	B	61.7/60.1
R153	7030003520	S.RES ERJ3GEYJ 472 V (4.7K)	T	59.2/57.9
R201	7030003320	S.RES ERJ3GEYJ 101 V (100)	B	123/49.9
R202	7030003520	S.RES ERJ3GEYJ 472 V (4.7K)	B	136/49.8
R204	7030003440	S.RES ERJ3GEYJ 102 V (1K)	B	138/52.8
R205	7030010420	S.RES ERJ1TYJ 560U (56)	B	145/51.5
R301	7030009300	S.RES ERJ1WYOR00U	B	92.2/84.4
R302	7030010520	S.RES ERJ1TYJ 101U (100)	T	89.4/86.1
R303	7030009300	S.RES ERJ1WYOR00U	B	85.4/84.4
R304	7030003320	S.RES ERJ3GEYJ 101 V (100)	T	107.1/79.8
R305	7030010410	S.RES ERJ1TYJ 220U (22)	T	100.2/84.1
R306	7030003320	S.RES ERJ3GEYJ 101 V (100)	B	71.2/83.3
R307	7030010410	S.RES ERJ1TYJ 220U (22)	T	77.5/84.1
R308	7030003480	S.RES ERJ3GEYJ 222 V (2.2K)	B	99/84.1
R309	7030003480	S.RES ERJ3GEYJ 222 V (2.2K)	B	78.7/84.9
R310	7030007630	S.RES MCR100ZJH 0.68 (R68)	B	100.1/82.2
R311	7030007630	S.RES MCR100ZJH 0.68 (R68)	B	78.3/82.1
R312	7030011250	S.RES ERJ1TY 390U (39)	T	100.9/77.7
R313	7030010540	S.RES ERJ1TYJ 330U (33)	T	97.2/77.7
R314	7030010540	S.RES ERJ1TYJ 330U (33)	T	81.6/77.7
R315	7030011250	S.RES ERJ1TY 390U (39)	T	77.9/77.7
R317	7030010950	S.RES ERJ1TYJ 100U (10)	B	104/20.0
R318	7030010950	S.RES ERJ1TYJ 100U (10)	B	99.6/20.6
R319	7030010660	S.RES ERJ1TYJ 6R8U (6.8)	B	89.4/54.5
R402	7030003320	S.RES ERJ3GEYJ 101 V (100)	B	151.7/73.1
R403	7030003520	S.RES ERJ3GEYJ 472 V (4.7K)	T	151.8/71.2
R404	7030000260	S.RES MCR10EZJH 100 (101)	T	149.4/76
R405	7030003540	S.RES ERJ3GEYJ 682 V (6.8K)	B	126.7/137.5
R406	7030003860	S.RES ERJ3GE JPW V	B	128.4/136.1
R407	7030003440	S.RES ERJ3GEYJ 102 V (1K)	B	129.7/133.6
R408	7030003860	S.RES ERJ3GE JPW V	B	124.1/137.6
R409	7030003440	S.RES ERJ3GEYJ 102 V (1K)	B	127/130.4
R410	7030003440	S.RES ERJ3GEYJ 102 V (1K)	B	131.6/133
R411	7030003540	S.RES ERJ3GEYJ 682 V (6.8K)	B	125.1/135.5
R412	7030003500	S.RES ERJ3GEYJ 332 V (3.3K)	B	131.1/129.7
R413	7030007160	S.RES ERJ12YJ3R3U (3.3)	B	123.5/125.1
R415	7030008350	S.RES ERJ12YJ390U	B	86.7/136.4
R416	7030000140	S.RES MCR10EZJH 10 (100)	B	93.8/130.7
R417	7030000140	S.RES MCR10EZJH 10 (100)	B	95.5/132.5
R418	7030000010	S.RES MCR10EZJH JPW (000)	B	99.3/133.9
R451	7030003470	S.RES ERJ3GEYJ 182 V (1.8K)	B	81.5/121.7
R452	7030004040	S.RES ERJ3GEYJ 4R7 V (4.7)	B	85.5/119.3
R453	7030003260	S.RES ERJ3GEYJ 330 V (33)	B	81.6/118.4
R454	7030003860	S.RES ERJ3GE JPW V	B	77.3/116
R455	7030003640	S.RES ERJ3GEYJ 473 V (47K)	B	73.2/117.5
R456	7030003700	S.RES ERJ3GEYJ 154 V (150K)	B	72/114.4
R457	7030003750	S.RES ERJ3GEYJ 394 V (390K)	B	71.2/111.9
R458	7030003710	S.RES ERJ3GEYJ 184 V (180K)	B	73.8/112.4
R459	7030003740	S.RES ERJ3GEYJ 334 V (330K)	B	69.6/111.3
R460	7030003740	S.RES ERJ3GEYJ 334 V (330K)	B	76.6/112.1
R461	7030003270	S.RES ERJ3GEYJ 390 V (39)	B	77.7/103.3
R462	7030003680	S.RES ERJ3GEYJ 104 V (100K)	B	72.9/99.6
R463	7030003520	S.RES ERJ3		

[PA UNIT]

REF NO.	PARTS NO.	DESCRIPTION	M.	H/V LOCATION
R511	7030003540	S.RES ERJ3GEYJ 682 V (6.8K)	B	112.1/133.9
R512	7030003560	S.RES ERJ3GEYJ 103 V (10K)	B	107.1/123.1
R513	7030010520	S.RES ERJ1TYJ 101U (100)	B	103.7/114.2
R515	7030006060	S.RES ERJ12YJ100U (10)	T	92.1/108.9
R516	7030003860	S.RES ERJ3GE JPW V	T	90.6/114.3
R517	7030010520	S.RES ERJ1TYJ 101U (100)	B	103.7/118.4
R518	7030003440	S.RES ERJ3GEYJ 102 V (1K)	B	97.4/112.6
R519	7030000010	S.RES MCR10EZHZ JPW (000)	B	111.1/119.1
R551	7030003470	S.RES ERJ3GEYJ 182 V (1.8K)	T	78.2/117.8
R552	7030004040	S.RES ERJ3GEYJ 4R7 V (4.7)	T	76.7/119.1
R553	7030003260	S.RES ERJ3GEYJ 330 V (33)	T	73/118.9
R554	7030003680	S.RES ERJ3GEYJ 104 V (100K)	T	66.8/120.4
R555	7030003440	S.RES ERJ3GEYJ 102 V (1K)	T	68.1/114.7
R556	7030003680	S.RES ERJ3GEYJ 104 V (100K)	T	69.9/116.6
R557	7030003740	S.RES ERJ3GEYJ 334 V (330K)	T	65.7/112.9
R558	7030003710	S.RES ERJ3GEYJ 184 V (180K)	T	70.5/111.2
R559	7030003720	S.RES ERJ3GEYJ 224 V (220K)	T	65.7/111.7
R560	7030003720	S.RES ERJ3GEYJ 224 V (220K)	T	65.6/110.5
R561	7030003740	S.RES ERJ3GEYJ 334 V (330K)	T	68.3/112.4
R562	7030003270	S.RES ERJ3GEYJ 390 V (39)	T	70.1/106.6
R563	7030003420	S.RES ERJ3GEYJ 681 V (680)	T	65.4/107.3
R564	7030003210	S.RES ERJ3GEYJ 120 V (12)	T	63.5/103
R565	7030003440	S.RES ERJ3GEYJ 102 V (1K)	B	65.6/106.3
R567	7030003680	S.RES ERJ3GEYJ 104 V (100K)	T	70.1/104
R568	7030003680	S.RES ERJ3GEYJ 104 V (100K)	T	69.7/107.7
R570	7030003380	S.RES ERJ3GEYJ 331 V (330)	T	62.8/100.3
R575	7030003520	S.RES ERJ3GEYJ 472 V (4.7K)	T	68.4/100.7
R576	7030003540	S.RES ERJ3GEYJ 682 V (6.8K)	T	71.8/100
R577	7030003520	S.RES ERJ3GEYJ 472 V (4.7K)	T	68/120.4
R578	7030003540	S.RES ERJ3GEYJ 682 V (6.8K)	T	69.9/119
R701	7030003500	S.RES ERJ3GEYJ 332 V (3.3K)	B	82.2/16.9
R702	7030003500	S.RES ERJ3GEYJ 332 V (3.3K)	B	83/14.5
R703	7030003500	S.RES ERJ3GEYJ 332 V (3.3K)	B	80.6/16.9
R704	7030003500	S.RES ERJ3GEYJ 332 V (3.3K)	B	79.7/14.5
R705	7030009300	S.RES ERJ1WYOR00U	B	134.6/23.8
R721	7030011240	S.RES LRF3W-LF-01-R020F	B	83/22.3
R722	7030011240	S.RES LRF3W-LF-01-R020F	B	83/29.6
R723	7030004040	S.RES ERJ3GEYJ 4R7 V (4.7)	B	140.5/14.7
R733	7030009591	S.RES ERA3YED 472V (4.7K)	B	138.6/10.4
R734	7510001470	S.THE NTCG20 4AG 473JT	T	111.9/58.2
R735	7030009591	S.RES ERA3YED 472V (4.7K)	B	140.2/12.5
R736	7510001470	S.THE NTCG20 4AG 473JT	T	153.3/77.1
R742	7030003640	S.RES ERJ3GEYJ 473 V (47K)	B	83.4/11.5
R743	7030003440	S.RES ERJ3GEYJ 102 V (1K)	B	80.2/10.9
R744	7030003860	S.RES ERJ3GE JPW V	T	67.8/9.6
R749	7030003860	S.RES ERJ3GE JPW V	B	65/5.2
R750	7030003860	S.RES ERJ3GE JPW V	B	66.6/5.2
R773	7030003860	S.RES ERJ3GE JPW V	T	103.4/9.5
R960	7030003860	S.RES ERJ3GE JPW V	B	43.2/125.7
R961	7030003380	S.RES ERJ3GEYJ 331 V (330)	B	42/138.3
R962	7030003440	S.RES ERJ3GEYJ 102 V (1K)	B	37.4/137.8
R963	7030003440	S.RES ERJ3GEYJ 102 V (1K)	B	40.3/126.3
R964	7030003860	S.RES ERJ3GE JPW V	B	24.8/131.2
R965	7030003640	S.RES ERJ3GEYJ 473 V (47K)	B	32.6/130.5
R966	7030008190	S.RES ERJ12YJ330U (33)	B	11.1/129.6
R967	7030003640	S.RES ERJ3GEYJ 473 V (47K)	B	34.2/130.5
R968	7030003860	S.RES ERJ3GE JPW V	B	24.8/132.8
R969	7030003600	S.RES ERJ3GEYJ 223 V (22K)	B	32.6/133.6
R970	7030003680	S.RES ERJ3GEYJ 104 V (100K)	B	34.2/133.6
R971	7540000130	ABS 2P-50A-301		
R972	7030003620	S.RES ERJ3GEYJ 333 V (33K)	B	17.4/140.1
R973	7030003620	S.RES ERJ3GEYJ 333 V (33K)	B	18.9/138.5
R974	7030003620	S.RES ERJ3GEYJ 333 V (33K)	B	19.4/136.6
R994	7030003560	S.RES ERJ3GEYJ 103 V (10K)	B	22.4/2.6
R995	7030003560	S.RES ERJ3GEYJ 103 V (10K)	B	22.4/6.8
R996	7030003560	S.RES ERJ3GEYJ 103 V (10K)	B	21.6/5.4
R997	7030003560	S.RES ERJ3GEYJ 103 V (10K)	B	21.6/8.2
R998	7030003320	S.RES ERJ3GEYJ 101 V (100)	T	54.1/4.4
R999	7030003320	S.RES ERJ3GEYJ 101 V (100)	T	54.5/3.1
R1000	7030003320	S.RES ERJ3GEYJ 101 V (100)	T	51.2/3.5
R1001	7030003320	S.RES ERJ3GEYJ 101 V (100)	T	49.3/4.9
R1002	7030000280	S.RES MCR10EZHZ 150 (151)	T	48/9.7
R1003	7030000290	S.RES MCR10EZHZ 180 (181)	T	47.5/7.9
C101	4030011600	S.CER C1608 JB 1E 104K-T	T	151.9/25.1
C102	4030011600	S.CER C1608 JB 1E 104K-T	B	150.8/29.3
C103	4030011340	S.CER C1608 CH 1H 471J-T	T	152.7/27.2
C104	4030011600	S.CER C1608 JB 1E 104K-T	T	147.8/32.2
C105	4510004591	ELE 16 ME 470 HC		
C106	4030011600	S.CER C1608 JB 1E 104K-T	B	142.7/29.2
C107	4030011600	S.CER C1608 JB 1E 104K-T	T	151.6/39.7
C108	4030011600	S.CER C1608 JB 1E 104K-T	T	149.2/36.5
C109	4030007130	S.CER C1608 CH 1H 101J-T	B	146.6/42.1
C112	4030011600	S.CER C1608 JB 1E 104K-T	B	139.2/35.1
C113	4030011600	S.CER C1608 JB 1E 104K-T	T	144.6/44.4
C114	4030011600	S.CER C1608 JB 1E 104K-T	B	134.1/37
C116	4030007060	S.CER C1608 CH 1H 270J-T	T	144.6/45.8
C118	4030007130	S.CER C1608 CH 1H 101J-T	T	143.5/48.5
C119	4030007130	S.CER C1608 CH 1H 101J-T	T	144/50.4
C120	4030007020	S.CER C1608 CH 1H 120J-T	T	143.5/47.2
C122	4510008500	S.ELE EEE1CA101WP	T	121.5/11.2
C151	4030011600	S.CER C1608 JB 1E 104K-T	T	59.2/54.8
C152	4030006880	S.CER C1608 JB 1H 472K-T	B	61.6/36.2
C153	4030011600	S.CER C1608 JB 1E 104K-T	B	63.1/56
C154	4030006860	S.CER C1608 JB 1H 102K-T	B	63.1/54.7
C201	4030006860	S.CER C1608 JB 1H 102K-T	T	145.6/53

[PA UNIT]

REF NO.	PARTS NO.	DESCRIPTION	M.	H/V LOCATION
C202	4030006860	S.CER C1608 JB 1H 102K-T	T	143/53
C204	4030011600	S.CER C1608 JB 1E 104K-T	B	139.3/48.4
C205	4030006860	S.CER C1608 JB 1H 102K-T	B	123.3/48.6
C206	4030017810	S.CER C1608 CH 1H 102J-T	B	133.5/50.6
C207	4030017810	S.CER C1608 CH 1H 102J-T	B	139.3/49.7
C208	4030011600	S.CER C1608 JB 1E 104K-T	B	132/50.6
C209	4030007170	S.CER C1608 CH 1H 221J-T	B	139.3/51
C214	4030018940	S.CER GRM31A7U2J331JW31D	T	116.3/76.1
C215	4030018930	S.CER GRM31A7U2J221JW31D	T	122.2/73.9
C217	4030011600	S.CER C1608 JB 1E 104K-T	T	144.3/53
C218	4030018930	S.CER GRM31A7U2J221JW31D	T	101/88.5
C219	4030018930	S.CER GRM31A7U2J221JW31D	B	82.4/99.7
C251	4030011180	S.CER GRM31M2C2H220JV01L (GRM42-6 CH)	B	134.9/66
C252	4030011180	S.CER GRM31M2C2H220JV01L (GRM42-6 CH)	B	142.2/70.6
C253	4030011080	S.CER GRM31M2C2H6R0DV01L (GRM42-6 CH)	B	145.5/79
C254	4030011160	S.CER GRM31M2C2H150JV01L (GRM42-6 CH)	B	127.7/65.3
C261	4030012480	S.CER GRM31M2C2H121JV01L (GRM42-6 CH)	B	131.7/75.1
C262	4030018940	S.CER GRM31A7U2J331JW31D	B	126/80.1
C263	4030018770	S.CER C3216 CH 2J 102J-T	B	122.1/80.7
C266	4030018950	S.CER GRM31A7U2J681JW31D	B	119.7/80.2
C267	4030018930	S.CER GRM31A7U2J221JW31D	B	124/85.3
C301	4030001100	S.CER GRM216B1H102KA01D (GRM40 B)	B	91.7/100.6
C302	4030001020	S.CER GRM216C21H121JA01D (GRM40 CH)	B	93.8/100.6
C303	4030011600	S.CER C1608 JB 1E 104K-T	B	110.8/85.5
C304	4030017320	S.CER GRM21BB1H104KA01L (GRM40-034)	B	94.8/97.6
C305	4510004591	ELE 16 ME 470 CH		
C306	4030004720	S.CER C2012 JB 1H 102K-T	[EUR] B	83.6/39.8
	4030004720	S.CER C2012 JB 1H 102K-T	[FRA]	
	4030004720	S.CER C2012 JB 1H 102K-T	[ESP]	
	4030004720	S.CER C2012 JB 1H 102K-T	[JAP]	
	4030004720	S.CER C2012 JB 1H 102K-T	[KOR]	
	4030004720	S.CER C2012 JB 1H 102K-T	[UK]	
	4030004720	S.CER C2012 JB 1H 102K-T	[USA]	
	4030004720	S.CER C2012 JB 1H 102K-T	[CHN]	
	4030004720	S.CER C2012 JB 1H 102K-T	[AUS]	
	4030004720	S.CER C2012 JB 1H 102K-T	[KOR]	
	4030004720	S.CER C2012 JB 1H 102K-T	[UK]	
	4030004720	S.CER C2012 JB 1H 102K-T	[KOR]	
	4030004720	S.CER C2012 JB 1H 102K-T	[USA]	
	4030004720	S.CER C2012 JB 1H 102K-T	[ESP]	
	4030004720	S.CER C2012 JB 1H 102K-T	[FRA]	
	4030004720	S.CER C2012 JB 1H 102K-T	[UK]	
	4030004720	S.CER C2012 JB 1H 102K-T	[USA]	
	4030004720	S.CER C2012 JB 1H 102K-T	[EXP]	
	4030004720	S.CER C2012 JB 1H 102K-T	[ITR]	
	4030004720	S.CER C2012 JB 1H 102K-T	[UK]	
	4030004720	S.CER C2012 JB 1H 102K-T	[KOR]	
	4030006860	S.CER C1608 JB 1H 102K-T	[AUS]	
	4030004720	S.CER C2012 JB 1H 102K-T	[CHN]	
	4030004720	S.CER C2012 JB 1H 102K-T	[EUR]	
	4030004720	S.CER C2012 JB 1H 102K-T	[FRA]	
	4030004720	S.CER C2012 JB 1H 102K-T	[ESP]	
	4030004720	S.CER C2012 JB 1H 102K-T	[USA]	
	4030004720	S.CER C2012 JB 1H 102K-T	[EXP]	
	4030004720	S.CER C2012 JB 1H 102K-T	[ITR]	
	4030004720	S.CER C2012 JB 1H 102K-T	[UK]	
	4030004720	S.CER C2012 JB 1H 102K-T	[KOR]	
	4030004720	S.CER C2012 JB 1H 102K-T	[AUS]	
	4030004720	S.CER C2012 JB 1H 102K-T	[CHN]	
C309	4030011600	S.CER C1608 JB 1E 104K-T	T	105.8/78.3
C311	4030018750	S.CER C3225 CH 2J 682K-T	B	92.7/78.5
C312	4030018750	S.CER C3225 CH 2J 682K-T	B	84.9/78.5
C313	4030011600	S.CER C1608 JB 1E 104K-T	T	76.8/87.8
C314	4030018750	S.CER C3225 CH 2J 682K-T	B	96.9/77.6
C315	4030018750	S.CER C3225 CH 2J 682K-T	B	80.6/77.6
C319	4030011730	S.CER GRM31M2C2H101JV01L (GRM42-6 CH)	B	110/48.8
C320	4030011730	S.CER GRM31M2C2H101JV01L (GRM42-6 CH)	B	71.1/48.9
C323	4030003810	S.MIC UC342H 1200J-T	B	91.4/46.4
C324	4320001050	S.MIC UC342H 3900J-T	T	94.4/40.2
C325	4320001070	S.MIC UC342H 3300J-T	B	94.4/40.7
C327	40300011790	S.CER GRM55RF52A684ZD01L (GRM44-1)	T	65.9/46.3
C331	4030011600	S.CER C1608 JB 1E 104K-T	T	108.3/78.3
C332	4030011600	S.CER C1608 JB 1E 104K-T	B	69.5/81.4
C333	4030018940	S.CER GRM31A7U2J331JW31D	B	88.4/101.8
C340	4030006860	S.CER C1608 JB 1H 102K-T	B	82.3/107.3
C341	4030006860	S.CER C1608 JB 1H 102K-T	B	92.4/107.4
C342	4030006860	S.CER C1608 JB 1H 102K-T	B	87.1/91.6
C350	4030004720	S.CER C2012 JB 1H 102K-T	[EUR] B	103.4/39.8
	4030004720	S.CER C2012 JB 1H 102K-T	[FRA]	
	4030004720	S.CER C2012 JB 1H 102K-T	[ESP]	
	4030004720	S.CER C2012 JB 1H 102K-T	[USA]	
	4030004720	S.CER C2012 JB 1H 102K-T	[EXP]	
	4030004720	S.CER C2012 JB 1H 102K-T	[ITR]	
	4030004720	S.CER C2012 JB 1H 102K-T	[UK]	
	4030004720	S.CER C2012 JB 1H 102K-T	[KOR]	
	4030004720	S.CER C2012 JB 1H 102K-T	[CHN]	

M.=Mounted side (T: Mounted on the Top side, B: Mounted on the Bottom side)
S.=Surface mount

[PA UNIT]

REF NO.	PARTS NO.	DESCRIPTION	M.	H/V LOCATION
C351	4030004720	S.CER C2012 JB 1H 102K-T [EUR]	B	106.1/39.8
	4030004720	S.CER C2012 JB 1H 102K-T [FRA]		
	4030004720	S.CER C2012 JB 1H 102K-T [ESP]		
	4030004720	S.CER C2012 JB 1H 102K-T [USA]		
	4030004720	S.CER C2012 JB 1H 102K-T [EXP]		
	4030004720	S.CER C2012 JB 1H 102K-T [ITR]		
	4030004720	S.CER C2012 JB 1H 102K-T [UK]		
	4030004720	S.CER C2012 JB 1H 102K-T [KOR]		
	4030004720	S.CER C2012 JB 1H 102K-T [CHN]		
	4030004720	S.CER C2012 JB 1H 102K-T [EUR]	B	
C353	4030004720	S.CER C2012 JB 1H 102K-T [FRA]	B	86.3/39.8
	4030004720	S.CER C2012 JB 1H 102K-T [ESP]		
	4030004720	S.CER C2012 JB 1H 102K-T [USA]		
	4030004720	S.CER C2012 JB 1H 102K-T [EXP]		
	4030004720	S.CER C2012 JB 1H 102K-T [ITR]		
	4030004720	S.CER C2012 JB 1H 102K-T [UK]		
	4030004720	S.CER C2012 JB 1H 102K-T [KOR]		
	4030004720	S.CER C2012 JB 1H 102K-T [CHN]		
	4030004720	S.CER C2012 JB 1H 102K-T [FRA]	B	
	4030004720	S.CER C2012 JB 1H 102K-T [ESP]		
C354	4030004720	S.CER C2012 JB 1H 102K-T [USA]	B	89.1/39.8
	4030004720	S.CER C2012 JB 1H 102K-T [EXP]		
	4030004720	S.CER C2012 JB 1H 102K-T [ITR]		
	4030004720	S.CER C2012 JB 1H 102K-T [UK]		
	4030004720	S.CER C2012 JB 1H 102K-T [KOR]		
	4030004720	S.CER C2012 JB 1H 102K-T [CHN]		
	4030004720	S.CER C2012 JB 1H 102K-T [FRA]	B	
	4030004720	S.CER C2012 JB 1H 102K-T [ESP]		
	4030004720	S.CER C2012 JB 1H 102K-T [USA]	B	
	4030004720	S.CER C2012 JB 1H 102K-T [EXP]		
C356	4030004720	S.CER C2012 JB 1H 102K-T [ITR]	B	97.5/10.9
	4030004720	S.CER C2012 JB 1H 102K-T [UK]		
	4030004720	S.CER C2012 JB 1H 102K-T [KOR]		
	4030004720	S.CER C2012 JB 1H 102K-T [CHN]		
	4030004720	S.CER C2012 JB 1H 102K-T [EUR]	B	
	4030004720	S.CER C2012 JB 1H 102K-T [FRA]		
	4030004720	S.CER C2012 JB 1H 102K-T [ESP]		
	4030004720	S.CER C2012 JB 1H 102K-T [USA]		
	4030004720	S.CER C2012 JB 1H 102K-T [EXP]		
	4030004720	S.CER C2012 JB 1H 102K-T [ITR]		
C357	4030004720	S.CER C2012 JB 1H 102K-T [UK]	B	94.7/10.9
	4030004720	S.CER C2012 JB 1H 102K-T [KOR]		
	4030004720	S.CER C2012 JB 1H 102K-T [CHN]		
	4030004720	S.CER C2012 JB 1H 102K-T [EUR]	B	
	4030004720	S.CER C2012 JB 1H 102K-T [FRA]		
	4030004720	S.CER C2012 JB 1H 102K-T [ESP]		
	4030004720	S.CER C2012 JB 1H 102K-T [USA]		
	4030004720	S.CER C2012 JB 1H 102K-T [EXP]		
	4030004720	S.CER C2012 JB 1H 102K-T [ITR]		
	4030004720	S.CER C2012 JB 1H 102K-T [UK]		
C358	4030006860	S.CER C1608 JB 1H 102K-T [KOR]	B	90/91.6
	4030006860	S.CER C1608 JB 1H 102K-T [CHN]		
	4030006860	S.CER C1608 JB 1H 102K-T [EUR]	B	
	4030006860	S.CER C1608 JB 1H 102K-T [FRA]		
	4030006860	S.CER C1608 JB 1H 102K-T [ESP]		
	4030006860	S.CER C1608 JB 1H 102K-T [USA]		
	4030006860	S.CER C1608 JB 1H 102K-T [EXP]		
	4030006860	S.CER C1608 JB 1H 102K-T [ITR]		
	4030006860	S.CER C1608 JB 1H 102K-T [UK]		
	4030006860	S.CER C1608 JB 1H 102K-T [KOR]		
C359	4030006860	S.CER C1608 JB 1H 102K-T [CHN]	B	94.9/107.4
	4030006860	S.CER C1608 JB 1H 102K-T [EUR]	B	
	4030006860	S.CER C1608 JB 1H 102K-T [FRA]		
	4030006860	S.CER C1608 JB 1H 102K-T [ESP]		
	4030006860	S.CER C1608 JB 1H 102K-T [USA]		
	4030006860	S.CER C1608 JB 1H 102K-T [EXP]		
	4030006860	S.CER C1608 JB 1H 102K-T [ITR]		
	4030006860	S.CER C1608 JB 1H 102K-T [UK]		
	4030006860	S.CER C1608 JB 1H 102K-T [KOR]		
	4030006860	S.CER C1608 JB 1H 102K-T [CHN]		
C360	4030006860	S.CER C1608 JB 1H 102K-T [EUR]	B	85/107.3
	4030006860	S.CER C1608 JB 1H 102K-T [FRA]		
	4030006860	S.CER C1608 JB 1H 102K-T [ESP]		
	4030006860	S.CER C1608 JB 1H 102K-T [USA]		
	4030006860	S.CER C1608 JB 1H 102K-T [EXP]		
	4030006860	S.CER C1608 JB 1H 102K-T [ITR]		
	4030006860	S.CER C1608 JB 1H 102K-T [UK]		
	4030006860	S.CER C1608 JB 1H 102K-T [KOR]		
	4030006860	S.CER C1608 JB 1H 102K-T [CHN]		
	4030006860	S.CER C1608 JB 1H 102K-T [EUR]	B	
C403	4030006860	S.CER C1608 JB 1H 102K-T	B	89.6/133.4
C404	4030006860	S.CER C1608 JB 1H 102K-T	B	151.7/71.4
C405	4030011740	S.CER GRM32N2C2H201JV01L (GRM42-2 CH)	T	145.3/105.7
C406	4030006860	S.CER C1608 JB 1H 102K-T	B	132.4/129.7
C408	4030018040	S.CER ERF22X 6C2H 180J D01L	B	134.2/93
C409	4030018040	S.CER ERF22X 6C2H 180J D01L	B	145.4/93
C410	4030018260	S.CER ERF22X 6C2H 150J D01L	B	145.4/96.4
C411	4030018260	S.CER ERF22X 6C2H 150J D01L	B	134.2/96.4
C412	4030018770	S.CER C3216 CH 2J 102J-T	T	136/111.5
C413	4030018770	S.CER C3216 CH 2J 102J-T	T	139.8/102.7
C415	4030018410	S.CER ERF22X 6C2H 2R0C D01L	T	143.1/139.4
C416	4030006880	S.CER C1608 JB 1H 472K-T	T	103.1/96.7
C417	4030018040	S.CER ERF22X 6C2H 180J D01L	T	139.2/136.2
C418	4030011120	S.CER GRM31M2C2H100JV01L (GRM42-6 CH)	B	134.1/134.2
C419	4030011020	S.CER GRM31M4C2H1R0CY21L (GRM42-6 CK)	B	132.6/138.2
C420	4030011080	S.CER GRM31M2C2H6R0DV01L (GRM42-6 CH)	B	129.2/139.5
C421	4030011020	S.CER GRM31M4C2H1R0CY21L (GRM42-6 CK)	B	120.6/136.8
C422	4030011120	S.CER GRM31M2C2H100JV01L (GRM42-6 CH)	B	121.7/141.1
C423	4030007090	S.CER C1608 CH 1H 470J-T	B	127.8/131.7

[PA UNIT]

REF NO.	PARTS NO.	DESCRIPTION	M.	H/V LOCATION
C424	4030011090	S.CER GRM31M2C2H7R0DV01L (GRM42-6 CH)	B	119/140.3
C425	4030011180	S.CER GRM31M2C2H220JV01L (GRM42-6 CH)	T	121.6/137.4
C426	4030006860	S.CER C1608 JB 1H 102K-T	B	106.7/133.9
C427	4030011020	S.CER GRM31M4C2H1R0CY21L (GRM42-6 CK)	[EUR] B	102.6/139.6
	4030011020	S.CER GRM31M4C2H1R0CY21L (GRM42-6 CK)	[FRA]	
	4030011020	S.CER GRM31M4C2H1R0CY21L (GRM42-6 CK)	[ESP]	
	4030011020	S.CER GRM31M4C2H1R0CY21L (GRM42-6 CK)	[USA]	
	4030011020	S.CER GRM31M4C2H1R0CY21L (GRM42-6 CK)	[EXP]	
	4030011020	S.CER GRM31M4C2H1R0CY21L (GRM42-6 CK)	[ITR]	
	4030011040	S.CER GRM31M4C2H2R0CY21L (GRM42-6 CK)	[UK]	
	4030011020	S.CER GRM31M4C2H1R0CY21L (GRM42-6 CK)	[KOR]	
	4030011020	S.CER GRM31M4C2H1R0CY21L (GRM42-6 CK)	[AUS]	
	4030011020	S.CER GRM31M4C2H1R0CY21L (GRM42-6 CK)	[CHN]	
C428	4030011090	S.CER GRM31M2C2H7R0DV01L (GRM42-6 CH)	T	97/138.1
C429	4030017940	S.CER ERF22X 6C2H 680J D01L	T	92.3/136.9
C430	4030019410	S.CER GRM31A7U2J471JW31D	B	94.2/138
C431	4030011070	S.CER GRM31M2C2H5R0CY21L (GRM42-6 CH)	T	86.9/133.8
C432	4030004820	S.CER C2012 CH 1H 050C-T	B	99.2/139.3
C433	4030011090	S.CER GRM31M2C2H7R0DV01L (GRM42-6 CH)	T	76.1/132.2
C434	4030006860	S.CER C1608 JB 1H 102K-T	B	89.3/124.9
C435	4030006860	S.CER C1608 JB 1H 102K-T	B	97.2/127.7
C436	4030006860	S.CER C1608 JB 1H 102K-T	T	98.4/130.9
C438	4030006850	S.CER C1608 JB 1H 471K-T	B	90.8/134
C439	4030006860	S.CER C1608 JB 1H 102K-T	B	92.8/133.1
C440	4030004710	S.CER C2012 JB 1H 471K-T	B	103.5/135.5
C441	4030011090	S.CER GRM31M2C2H7R0DV01L (GRM42-6 CH)	T	137.6/140.4
C443	4030011020	S.CER GRM31M4C2H1R0CY21L (GRM42-6 CK)	B	122.1/131
C444	4030006860	S.CER C1608 JB 1H 102K-T	B	59.3/117.9
C452	4030007020	S.CER C1608 CH 1H 120J-T	B	87.3/119.3
C453	4030006860	S.CER C1608 JB 1H 102K-T	T	63.9/117.3
C456	4030009350	S.CER C1608 CH 1H 3R5B-T	T	78.2/118.4
C458	4030006860	S.CER C1608 JB 1H 102K-T	B	73.8/113.1
C461	4030011600	S.CER C1608 JB 1E 104K-T	B	68.8/113.3
C462	4030011600	S.CER C1608 JB 1E 104K-T	B	77.1/110.8
C463	4030006860	S.CER C1608 JB 1H 102K-T	B	79.7/109.6
C464	4030011600	S.CER C1608 JB 1E 104K-T	B	77.7/105.9
C465	4030011600	S.CER C1608 JB 1E 104K-T	B	67.7/108.9
C466	4030006860	S.CER C1608 JB 1H 102K-T	B	77.7/104.6
C467	4030006860	S.CER C1608 JB 1H 102K-T	B	67.7/107.6
C468	4030007020	S.CER C1608 CH 1H 120J-T	B	73.7/101.1
C470	4030011600	S.CER C1608 JB 1E 104K-T	B	77.7/101.7
C471	4030006860	S.CER C1608 JB 1H 102K-T	B	77.7/100.4
C472	4030009500	S.CER C1608 CH 1H 0R5B-T	B	69.7/105.2
C473	4030007040	S.CER C1608 CH 1H 180J-T	B	69.7/104
C474	4030009530	S.CER C1608 CH 1H 030B-T	B	67.7/101.7
C475	4030006860	S.CER C1608 JB 1H 102K-T	B	66.5/98.8
C476	4030006860	S.CER C1608 JB 1H 102K-T	B	68/111.3
C477	4030006860	S.CER C1608 JB 1H 102K-T	B	79.1/121.9
C478	4030006860	S.CER C1608 JB 1H 102K-T	B	57.7/120.5
C479	4030006860	S.CER C1608 JB 1H 102K-T	B	56.9/121.8
C480	4030007090	S.CER C1608 CH 1H 470J-T	B	63.4/100.8
C481	4030006860	S.CER C1608 JB 1H 102K-T	B	69.6/96.3
C482	4030006860	S.CER C1608 JB 1H 102K-T	B	67.9/94.5
C483	4030006860	S.CER C1608 JB 1H 102K-T	B	64.2/98.8
C484	4030007010	S.CER C1608 CH 1H 100D-T	B	74.3/108.1
C485	4030017810	S.CER C1608 CH 1H 102J-T	B	69.8/107.4
C501	4030006860	S.CER C1608 JB 1H 102K-T	T	109.3/87.9
C503	4030011070	S.CER GRM31M2C2H5R0CY21L (GRM42-6 CH)	T	119.4/130.3
C504	4030017960	S.CER ERF22X 6C2H 330J D01L	T	111.8/122.1
C505	4030011040	S.CER GRM31M4C2H2R0CY21L (GRM42-6 CK)	B	114.4/125.4
C506	4030011120	S.CER GRM31M2C2H100JV01L (GRM42-6 CH)	B	118.2/125.6
C507	4030011040	S.CER GRM31M4C2H2R0CY21L (GRM42-6 CK)	B	113.8/131.5
C508	4030011070	S.CER GRM31M2C2H5R0CY21L (GRM42-6 CH)	B	110.4/132.8
C509	4030007150	S.CER C1608 CH 1H 151J-T	B	110.2/121.5
C511	4030018770	S.CER C3216 CH 2J 102J-T	T	109.6/125.4
C513	4030006860	S.CER C1608 JB 1H 102K-T	B	97.1/117.6
C514	4030011170	S.CER GRM31M2C2H180JV01L (GRM42-6 CH)	T	98.4/118.1
C515	4030018770	S.CER C3216 CH 2J 102J-T	T	96.9/120.4
C516	4030011100	S.CER GRM31M2C2H8R0DV01L (GRM42-6 CH)	T	88.2/124.1
C517	4030004880	S.CER C2012 CH 1H 120J-T	B	92.5/115.1
C518	4030018770	S.CER C3216 CH 2J 102J-T	B	94.1/121.4
C519	4030011190	S.CER GRM31M2C2H270JV01L (GRM42-6 CH)	T	86.1/124.1

M.=Mounted side (T: Mounted on the Top side, B: Mounted on the Bottom side)
S.=Surface mount

[PA UNIT]

REF NO.	PARTS NO.	DESCRIPTION	M.	H/V LOCATION
C520	4030004870	S.CER C2012 CH 1H 100D-T	B	93.4/112.4
C521	4030011290	S.CER GRM31M2C2H240JV01L (GRM42-6 CH)	T	81.2/123.9
C522	4030006850	S.CER C1608 JB 1H 471K-T	T	96.3/107.7
C523	4030006860	S.CER C1608 JB 1H 102K-T	T	79.3/119.1
C524	4030006910	S.CER C1608 CH 1H 0R5C-T	T	79.9/120.9
C525	4030004720	S.CER C2012 JB 1H 102K-T	T	86.7/112.1
C526	4030007150	S.CER C1608 CH 1H 151J-T	B	113.3/121.5
C527	4030007150	S.CER C1608 CH 1H 151J-T	B	111.1/127.8
C528	4030006860	S.CER C1608 JB 1H 102K-T	B	96.2/114.5
C530	4030011230	S.CER GRM31M2C2H390JV01L (GRM42-6 CH)	T	120.8/113.3
C531	4030018770	S.CER C3216 CH 2J 102J-T	B	106/109.3
C532	4030018770	S.CER C3216 CH 2J 102J-T	B	103.1/109.2
C533	4030018770	S.CER C3216 CH 2J 102J-T	T	118.6/107
C534	4030017880	S.CER ERF22X 6C2H 560J D01L (GRM111)	B	112.7/103.9
C535	4030017880	S.CER ERF22X 6C2H 560J D01L (GRM111)	B	124.1/103.9
C536	4030017980	S.CER ERF22X 6C2H 470J D01L	T	101/110.8
C537	4030017940	S.CER ERF22X 6C2H 680J D01L	T	101/114.2
C538	4030017880	S.CER ERF22X 6C2H 560J D01L (GRM111)	T	131.2/117.5
C541	4030011060	S.CER GRM31M2C2H4R0CY21L (GRM42-6 CH)	T	125.1/123.7
C542	4030012480	S.CER GRM31M2C2H121JV01L (GRM42-6 CH)	T	123.4/128.7
C544	4030011730	S.CER GRM31M2C2H101JV01L (GRM42-6 CH)	T	129.9/123.5
C545	4030017940	S.CER ERF22X 6C2H 680J D01L	B	112.7/109.9
C551	4030006880	S.CER C1608 JB 1H 472K-T	T	80.1/117.1
C552	4030006860	S.CER C1608 JB 1H 102K-T	T	73/120.5
C553	4030006850	S.CER C1608 JB 1H 471K-T	T	69.4/114.7
C554	4030006860	S.CER C1608 JB 1H 102K-T	T	66.8/114.7
C555	4030006860	S.CER C1608 JB 1H 102K-T	T	63.1/111.7
C556	4030011600	S.CER C1608 JB 1E 104K-T	T	68.3/111.2
C557	4030006860	S.CER C1608 JB 1H 102K-T	T	70.8/108.5
C558	4030006860	S.CER C1608 JB 1H 102K-T	T	65.4/108.6
C559	4030006860	S.CER C1608 JB 1H 102K-T	T	66/103.5
C560	4030006860	S.CER C1608 JB 1H 102K-T	B	65.3/112.9
C561	4030006850	S.CER C1608 JB 1H 471K-T	T	70.1/105.3
C562	4030006860	S.CER C1608 JB 1H 102K-T	T	69.2/94.9
C563	4030006860	S.CER C1608 JB 1H 102K-T	T	62.3/106.1
C564	4030006860	S.CER C1608 JB 1H 102K-T	T	65/97
C565	4030006860	S.CER C1608 JB 1H 102K-T	T	62.3/103
C567	4030006860	S.CER C1608 JB 1H 102K-T	T	69.2/120.9
C601	4030011070	S.CER GRM31M2C2H5R0CY21L (GRM42-6 CH)	T	69.5/132.7
C602	4030011090	S.CER GRM31M2C2H7R0DV01L (GRM42-6 CH)	T	67/136.8
C701	4030017320	S.CER GRM21BB11H104KA01L (GRM40-034)	B	109.8/33.4
C702	4030006860	S.CER C1608 JB 1H 102K-T	B	107.7/33.2
C703	4030011600	S.CER C1608 JB 1E 104K-T	B	83.8/16.9
C704	4510004601	ELE 16 ME 1000 HC		
C705	4030011600	S.CER C1608 JB 1E 104K-T	B	79/16.9
C706	4510004601	ELE 16 ME 1000 HC		
C707	4030017320	S.CER GRM21BB11H104KA01L (GRM40-034)	B	67.1/18.6
C708	4030006900	S.CER C1608 JB 1H 103K-T	T	63.2/27.8
C709	4030006860	S.CER C1608 JB 1H 102K-T	T	63.2/26.5
C710	4030006850	S.CER C1608 JB 1H 471K-T	T	63.2/25.2
C711	4030007170	S.CER C1608 CH 1H 221J-T	T	63.2/23.9
C712	4030007170	S.CER C1608 CH 1H 221J-T	B	70.4/18.7
C713	4510004591	ELE 16 ME 470 HC		
C715	4030006860	S.CER C1608 JB 1H 102K-T	B	97.1/118.9
C718	4030011600	S.CER C1608 JB 1E 104K-T	B	128.4/19.3
C719	4030011600	S.CER C1608 JB 1E 104K-T	T	125.8/16.4
C720	4030011600	S.CER C1608 JB 1E 104K-T	B	130.5/38.7
C722	4030007130	S.CER C1608 CH 1H 101J-T	T	88.9/6.7
C723	4030007130	S.CER C1608 CH 1H 101J-T	T	78.3/3.1
C724	4030011340	S.CER C1608 CH 1H 471J-T	B	134.8/12.2
C725	4550007350	STAN F931C226MCMBMA	B	126.6/35.3
C726	4030006860	S.CER C1608 JB 1H 102K-T	B	91.3/111
C727	4030006860	S.CER C1608 JB 1H 102K-T	B	84.4/114.1
C728	4030006860	S.CER C1608 JB 1H 102K-T	B	91.2/112.6
C729	4030006860	S.CER C1608 JB 1H 102K-T	B	65.1/114.8
C732	4030011600	S.CER C1608 JB 1E 104K-T	T	71.8/2.6
C733	4030011600	S.CER C1608 JB 1E 104K-T	T	66.8/12.9
C734	4030006860	S.CER C1608 JB 1H 102K-T	B	63.5/1.8
C735	4030011600	S.CER C1608 JB 1E 104K-T	T	74.1/13.2
C736	4030011600	S.CER C1608 JB 1E 104K-T	B	67.3/1.8
C737	4030011600	S.CER C1608 JB 1E 104K-T	B	65.4/1.8
C738	4030011600	S.CER C1608 JB 1E 104K-T	B	68.2/14.5
C739	4030011600	S.CER C1608 JB 1E 104K-T	B	69.8/14.5
C741	4030011600	S.CER C1608 JB 1E 104K-T	B	78.5/6.4
C742	4030011600	S.CER C1608 JB 1E 104K-T	T	69.4/12.9
C743	4030006860	S.CER C1608 JB 1H 102K-T	T	68.1/12.9
C744	4030011600	S.CER C1608 JB 1E 104K-T	T	70.7/12.9
C745	4030011600	S.CER C1608 JB 1E 104K-T	B	77.7/14.3
C746	4030011600	S.CER C1608 JB 1E 104K-T	B	76.2/15.1
C747	4030011600	S.CER C1608 JB 1E 104K-T	T	98.5/4.1
C749	4030011600	S.CER C1608 JB 1E 104K-T	T	96.6/6.4
C750	4030006880	S.CER C1608 JB 1H 472K-T	T	94.2/6.4
C751	4030006860	S.CER C1608 JB 1H 102K-T	T	95.4/6.4
C752	4030011600	S.CER C1608 JB 1E 104K-T	T	93/6.4
C753	4030006880	S.CER C1608 JB 1H 472K-T	B	59.9/10.7

[PA UNIT]

REF NO.	PARTS NO.	DESCRIPTION	M.	H/V LOCATION
C754	4030006860	S.CER C1608 JB 1H 102K-T	B	66.6/14.5
C755	4030006860	S.CER C1608 JB 1H 102K-T	B	58.5/119.2
C757	4030011600	S.CER C1608 JB 1E 104K-T	B	76.4/8
C759	4030006880	S.CER C1608 JB 1H 472K-T	T	72.8/13.2
C760	4030006880	S.CER C1608 JB 1H 472K-T	B	74.8/8
C761	4030006880	S.CER C1608 JB 1H 472K-T	B	73.2/8
C762	4030006880	S.CER C1608 JB 1H 472K-T	B	70/8
C763	4030006880	S.CER C1608 JB 1H 472K-T	B	71.6/8
C764	4030006880	S.CER C1608 JB 1H 472K-T	B	61.9/1.8
C765	4030011600	S.CER C1608 JB 1E 104K-T	B	68.9/1.8
C766	4030006860	S.CER C1608 JB 1H 102K-T	B	66.5/8.7
C781	4030006860	S.CER C1608 JB 1H 102K-T	T	73/90.1
C782	4030006900	S.CER C1608 JB 1H 103K-T	T	71.8/84.3
C783	4030006880	S.CER C1608 JB 1H 472K-T	T	71.8/83.1
C801	4030007070	S.CER C1608 CH 1H 330J-T	T	55/58.5
C802	4030009470	S.CER C1608 CH 1H R75C-T	T	53.7/58.5
C803	4030007100	S.CER C1608 CH 1H 560J-T	T	53.8/53.2
C804	4030007030	S.CER C1608 CH 1H 150J-T	T	56.2/52.5
C805	4030007080	S.CER C1608 CH 1H 390J-T	T	53.8/51.6
C806	4030006880	S.CER C1608 JB 1H 472K-T	B	47.1/39.8
C807	4030011600	S.CER C1608 JB 1E 104K-T	B	43.2/38.6
C808	4030011600	S.CER C1608 JB 1E 104K-T	B	43.1/44.5
C820	4030011600	S.CER C1608 JB 1E 104K-T	B	54.1/91.2
C821	4030006880	S.CER C1608 JB 1H 472K-T	B	53.5/99.2
C822	4030011510	S.CER GRM31M2C2H560JV01L (GRM42-6 CH)	B	42.2/21.9
C823	4030011190	S.CER GRM31M2C2H270JV01L (GRM42-6 CH)	B	32.9/18.3
C824	4030012480	S.CER GRM31M2C2H121JV01L (GRM42-6 CH)	B	25.1/17.1
C825	4030011240	S.CER GRM31M2C2H470JV01L (GRM42-6 CH)	B	17.9/15.7
C826	4030011550	S.CER GRM31M2C2H680JV01L (GRM42-6 CH)	B	11.2/19.9
C827	4030011510	S.CER GRM31M2C2H560JV01L (GRM42-6 CH)	B	8.8/19.9
C828	4030006880	S.CER C1608 JB 1H 472K-T	T	5.2/106.7
C829	4030011600	S.CER C1608 JB 1E 104K-T	T	2.6/106.7
C830	4030011210	S.CER GRM31M2C2H330JV01L (GRM42-6 CH)	B	22.4/17.1
C831	4030006880	S.CER C1608 JB 1H 472K-T	B	7.5/109.2
C832	4030006880	S.CER C1608 JB 1H 472K-T	B	51.5/95.4
C833	4030011730	S.CER GRM31M2C2H101JV01L (GRM42-6 CH)	B	27.5/17.1
C835	4030012480	S.CER GRM31M2C2H121JV01L (GRM42-6 CH)	B	16.6/107.1
C836	4030012480	S.CER GRM31M2C2H121JV01L (GRM42-6 CH)	B	12.5/107.8
C837	4030012480	S.CER GRM31M2C2H121JV01L (GRM42-6 CH)	B	12.5/105.7
C840	4030011600	S.CER C1608 JB 1E 104K-T	B	42.8/97.3
C841	4030006880	S.CER C1608 JB 1H 472K-T	B	46/98.5
C842	4030011730	S.CER GRM31M2C2H101JV01L (GRM42-6 CH)	B	39/106.8
C843	4010008160	CER HM13SJ SL 431J 500V		
C844	4030011730	S.CER GRM31M2C2H101JV01L (GRM42-6 CH)	B	25.9/102.9
C845	4030014460	S.CER GRM31M2C2H820JV01L (GRM42-6 CH)	B	19.7/91.9
C846	4010005370	CER HM11SJ SL 331J 500V		
C847	4010005930	CER HM11SJ SL 391J 500V		
C848	4030011190	S.CER GRM31M2C2H270JV01L (GRM42-6 CH)	B	12.5/98.2
C849	4030011180	S.CER GRM31M2C2H220JV01L (GRM42-6 CH)	B	12.6/96.1
C850	4010005930	CER HM11SJ SL 391J 500V		
C851	4030012480	S.CER GRM31M2C2H121JV01L (GRM42-6 CH)	B	20.2/112
C852	4030006880	S.CER C1608 JB 1H 472K-T	T	5.3/90.5
C853	4030011600	S.CER C1608 JB 1E 104K-T	T	2.6/90.5
C854	4030006880	S.CER C1608 JB 1H 472K-T	B	7.7/92.8
C855	4030011730	S.CER GRM31M2C2H101JV01L (GRM42-6 CH)	B	27.9/104.9
C856	4030011510	S.CER GRM31M2C2H560JV01L (GRM42-6 CH)	B	31.2/105.5
C857	4030012480	S.CER GRM31M2C2H121JV01L (GRM42-6 CH)	B	43.1/108.3
C858	4030011730	S.CER GRM31M2C2H101JV01L (GRM42-6 CH)	B	20.2/109.9
C860	4030011600	S.CER C1608 JB 1E 104K-T	B	43.4/83.8
C861	4030006880	S.CER C1608 JB 1H 472K-T	B	46.6/83.8
C863	4030011170	S.CER GRM31M2C2H180JV01L (GRM42-6 CH)	B	37.5/93.5
C864	4030011510	S.CER GRM31M2C2H560JV01L (GRM42-6 CH)	B	28.5/82.6
C865	4030011110	S.CER GRM31M2C2H9R0DV01L (GRM42-6 CH)	B	29.4/78.6
C866	4030011230	S.CER GRM31M2C2H390JV01L (GRM42-6 CH)	B	24.4/78
C868	4030011240	S.CER GRM31M2C2H470JV01L (GRM42-6 CH)	B	26.8/78.6
C869	4030011180	S.CER GRM31M2C2H220JV01L (GRM42-6 CH)	B	10.3/83.5
C870	4030011170	S.CER GRM31M2C2H180JV01L (GRM42-6 CH)	B	17/77.7
C871	4030006880	S.CER C1608 JB 1H 472K-T	T	5.2/74.4

M.=Mounted side (T: Mounted on the Top side, B: Mounted on the Bottom side)
S.=Surface mount

[PA UNIT]

REF NO.	PARTS NO.	DESCRIPTION	M.	H/V LOCATION
C872	4030011600	S.CER C1608 JB 1E 104K-T	T	2.5/74.4
C873	4030011070	S.CER GRM31M2C2H5R0CY21L (GRM42-6 CH)	B	33.2/92.6
C874	4030006880	S.CER C1608 JB 1H 472K-T	B	9/74.5
C876	4030011160	S.CER GRM31M2C2H150JV01L (GRM42-6 CH)	B	22/77.4
C880	4030011600	S.CER C1608 JB 1E 104K-T	B	43.4/69.1
C881	4030006880	S.CER C1608 JB 1H 472K-T	B	47/69.1
C882	4010007590	CER HM15SJ SL 681J 500V		
C883	4010007590	CER HM15SJ SL 681J 500V		
C884	4010005930	CER HM11SJ SL 391J 500V		
C885	4320000320	DIP DM20C 222J5		
C886	4030012480	S.CER GRM31M2C2H121JV01L (GRM42-6 CH)	B	31.5/57.2
C887	4030011730	S.CER GRM31M2C2H101JV01L (GRM42-6 CH)	B	33.9/57.2
C889	4030014460	S.CER GRM31M2C2H820JV01L (GRM42-6 CH)	B	18/65.3
C890	4320001250	DIP DM19C 162J5		
C893	4030006880	S.CER C1608 JB 1H 472K-T	T	5.3/58.3
C894	4030011600	S.CER C1608 JB 1E 104K-T	T	2.6/58.3
C900	4030011600	S.CER C1608 JB 1E 104K-T	B	44/54.4
C901	4030006880	S.CER C1608 JB 1H 472K-T	B	46.8/54.4
C902	4010005870	CER HM95SJ SL 221J 500V		
C903	4030011190	S.CER GRM31M2C2H270JV01L (GRM42-6 CH)	B	30.9/42.7
C904	4030014460	S.CER GRM31M2C2H820JV01L (GRM42-6 CH)	B	28.4/42.7
C905	4010005870	CER HM95SJ SL 221J 500V		
C906	4030011510	S.CER GRM31M2C2H560JV01L (GRM42-6 CH)	B	17/44
C907	4030011510	S.CER GRM31M2C2H560JV01L (GRM42-6 CH)	B	10.8/49.5
C908	4030006880	S.CER C1608 JB 1H 472K-T	T	5.3/42.1
C909	4030011600	S.CER C1608 JB 1E 104K-T	T	2.6/42.1
C920	4030011600	S.CER C1608 JB 1E 104K-T	B	43.2/25.1
C921	4030006880	S.CER C1608 JB 1H 472K-T	B	47.1/25.4
C922	4010007590	CER HM15SJ SL 681J 500V		
C923	4030011730	S.CER GRM31M2C2H101JV01L (GRM42-6 CH)	B	31.4/27.3
C924	4010006410	CER HM13SJ SL 471J 500V		
C925	4030014460	S.CER GRM31M2C2H820JV01L (GRM42-6 CH)	B	15.7/29.5
C926	4010006410	CER HM13SJ SL 471J 500V		
C927	4010005930	CER HM11SJ SL 391J 500V		
C928	4010005930	CER HM11SJ SL 391J 500V		
C929	4030006880	S.CER C1608 JB 1H 472K-T	T	5.3/25.8
C930	4030011600	S.CER C1608 JB 1E 104K-T	T	2.6/25.8
C931	4030014460	S.CER GRM31M2C2H820JV01L (GRM42-6 CH)	B	34.1/27.3
C932	4030011730	S.CER GRM31M2C2H101JV01L (GRM42-6 CH)	B	33.3/32.4
C933	4030011730	S.CER GRM31M2C2H101JV01L (GRM42-6 CH)	B	29.7/30.9
C940	4030011600	S.CER C1608 JB 1E 104K-T	B	43.6/11.1
C941	4030006880	S.CER C1608 JB 1H 472K-T	B	43.6/14.2
C942	4030014460	S.CER GRM31M2C2H820JV01L (GRM42-6 CH)	B	39.5/119.2
C943	4030011210	S.CER GRM31M2C2H330JV01L (GRM42-6 CH)	B	28.9/111.7
C944	4030014460	S.CER GRM31M2C2H820JV01L (GRM42-6 CH)	B	24.7/118.4
C945	4030011170	S.CER GRM31M2C2H180JV01L (GRM42-6 CH)	B	16.5/118.1
C947	4030006880	S.CER C1608 JB 1H 472K-T	T	5.3/9.9
C948	4030011600	S.CER C1608 JB 1E 104K-T	T	2.6/9.9
C949	4030011050	S.CER GRM31M3C2H3R0CY21L (GRM42-6 CJ)	B	28.9/109.6
C960	4030010760	S.CER C1608 CH 1H 331J-T	T	18.1/130.2
C961	4030011600	S.CER C1608 JB 1E 104K-T	B	45.1/134.1
C962	4030006880	S.CER C1608 JB 1H 472K-T	B	39/137.8
C963	4030006880	S.CER C1608 JB 1H 472K-T	B	38.7/126.3
C964	4610002120	S.TRI TZB4Z100EB10R00 (TZBX4Z100BE110)	T	3.3/126.6
C966	4030006880	S.CER C1608 JB 1H 472K-T	B	21.2/131.2
C968	4030011340	S.CER C1608 CH 1H 471J-T	B	31/130.5
C969	4030011340	S.CER C1608 CH 1H 471J-T	B	31/133.6
C970	4030010760	S.CER C1608 CH 1H 331J-T	B	22/132.8
C971	4030011340	S.CER C1608 CH 1H 471J-T	B	35.8/133.6
C972	4030011790	S.CER GRM55RF52A684ZD01L (GRM44-1)	B	3.4/136.4
C973	4030007090	S.CER C1608 CH 1H 470J-T	T	8.3/129.8
C979	4030006880	S.CER C1608 JB 1H 472K-T	T	51.8/38.6
C987	4030006880	S.CER C1608 JB 1H 472K-T	B	28.9/3.3
C988	4030006880	S.CER C1608 JB 1H 472K-T	B	26.3/3.3
C989	4030006880	S.CER C1608 JB 1H 472K-T	B	25/2.6
C990	4030006880	S.CER C1608 JB 1H 472K-T	T	20.6/3
C991	4030006880	S.CER C1608 JB 1H 472K-T	T	20.6/4.2
C992	4030006880	S.CER C1608 JB 1H 472K-T	T	20.6/5.4
C993	4030006880	S.CER C1608 JB 1H 472K-T	T	20.6/6.6
C994	4030011600	S.CER C1608 JB 1E 104K-T	B	29.5/6.1
C995	4030006880	S.CER C1608 JB 1H 472K-T	B	23.7/3.4
C996	4030007090	S.CER C1608 CH 1H 470J-T	T	20.6/9
C997	4030007090	S.CER C1608 CH 1H 470J-T	T	20.6/7.8
C998	4030007090	S.CER C1608 CH 1H 470J-T	T	20.6/10.2
C999	4030006860	S.CER C1608 JB 1H 102K-T	T	56.8/9.5
C1000	4030006860	S.CER C1608 JB 1H 102K-T	B	55.5/5

[PA UNIT]

REF NO.	PARTS NO.	DESCRIPTION	M.	H/V LOCATION
C1001	4030011600	S.CER C1608 JB 1E 104K-T	B	51.6/1.7
C1002	4030006880	S.CER C1608 JB 1H 472K-T	B	27.6/2.6
C1003	4030011600	S.CER C1608 JB 1E 104K-T	T	49.8/7.6
C1004	4030011510	S.CER GRM31M2C2H560JV01L (GRM42-6 CH)	B	39.8/21.9
C1005	4030011550	S.CER GRM31M2C2H680JV01L (GRM42-6 CH)	B	16.8/91.9
C1006	4030014460	S.CER GRM31M2C2H820JV01L (GRM42-6 CH)	B	39/109.2
C1007	4030011550	S.CER GRM31M2C2H680JV01L (GRM42-6 CH)	B	18.1/62.1
C1009	4030011510	S.CER GRM31M2C2H560JV01L (GRM42-6 CH)	B	20.6/118.7
C1010	4030014460	S.CER GRM31M2C2H820JV01L (GRM42-6 CH)	B	27.1/119.5
C1121	4010006410	CER HM13SJ SL 471J 500V		
RL701	6330001550	REL JV-12-KT		
RL801	6330001721	REL ATN207-K1		
RL820	6330001721	REL ATN207-K1		
RL821	6330001721	REL ATN207-K1		
RL840	6330001721	REL ATN207-K1		
RL841	6330001721	REL ATN207-K1		
RL860	6330001721	REL ATN207-K1		
RL861	6330001721	REL ATN207-K1		
RL880	6330001721	REL ATN207-K1		
RL881	6330001721	REL ATN207-K1		
RL900	6330001721	REL ATN207-K1		
RL901	6330001721	REL ATN207-K1		
RL920	6330001721	REL ATN207-K1		
RL921	6330001721	REL ATN207-K1		
RL940	6330001721	REL ATN207-K1		
RL941	6330001721	REL ATN207-K1		
J2	6510023511	S.CON 28FLT-SM2-TB(LF)(SN)	T	80.1/6
J980	6510023511	S.CON 28FLT-SM2-TB(LF)(SN)	T	63.7/6
F1	5220000341	HOL FHA010-03F		
F2	5210000940	FUS 1205		
W101	8970024640	1.5D175MM C24/C31		
W401	8970024650	1.5D 200MM (SX2427 A5-6G1)		
W701	8900013900	CAB OPC-1455		
W702	8900013910	CAB OPC-1456		
W801	7120000480	S.JUM MJP-0.4-T	B	8.3/100.9
W901	7120000480	S.JUM MJP-0.4-T	T	56.7/22
EP202	6910012350	S.BEA MMZ1608Y 102BT	B	136/51.3
EP703	6910012350	S.BEA MMZ1608Y 102BT	B	142.6/13.9
EP741	6910012350	S.BEA MMZ1608Y 102BT	B	76.4/11.9
EP742	6910012350	S.BEA MMZ1608Y 102BT	B	77.8/11.3
EP743	6910012350	S.BEA MMZ1608Y 102BT	B	59.8/99.5
EP747	6910012350	S.BEA MMZ1608Y 102BT	T	65/9.6
EP748	6910012350	S.BEA MMZ1608Y 102BT	T	63.8/9.6
EP751	6910012350	S.BEA MMZ1608Y 102BT	T	74.1/9.6
EP752	6910012350	S.BEA MMZ1608Y 102BT	B	63.4/5.2
EP753	6910012350	S.BEA MMZ1608Y 102BT	T	66.4/9.6
EP754	6910012350	S.BEA MMZ1608Y 102BT	B	59.3/115.8
EP756	6910012350	S.BEA MMZ1608Y 102BT	T	68.6/2.6
EP758	6910012350	S.BEA MMZ1608Y 102BT	T	70.3/9.6
EP759	6910012350	S.BEA MMZ1608Y 102BT	T	69.1/9.6
EP760	6910012350	S.BEA MMZ1608Y 102BT	T	60.6/10
EP761	6910012350	S.BEA MMZ1608Y 102BT	T	62.5/9.6
EP762	6910012350	S.BEA MMZ1608Y 102BT	B	61/4.6
EP763	6910012350	S.BEA MMZ1608Y 102BT	B	63.3/105.6
EP767	6910012350	S.BEA MMZ1608Y 102BT	B	76.4/5.2
EP772	6910012350	S.BEA MMZ1608Y 102BT	T	96.4/3.8
EP774	6910012350	S.BEA MMZ1608Y 102BT	T	72.8/9.6
EP775	6910012350	S.BEA MMZ1608Y 102BT	B	74.8/5.2
EP776	6910012350	S.BEA MMZ1608Y 102BT	B	73.2/5.2
EP777	6910012350	S.BEA MMZ1608Y 102BT	B	70/5.2
EP778	6910012350	S.BEA MMZ1608Y 102BT	B	71.6/5.2
EP779	6910012350	S.BEA MMZ1608Y 102BT	B	68.2/5.2
W1	8900015480	CAB OPC-1447A (P0.5,N10,L30) <TJM>		
W2	8900013991	CAB OPC-1445A		
EP1	0880001670	UNI EX-2832		

M.=Mounted side (T: Mounted on the Top side, B: Mounted on the Bottom side)
S.=Surface mount

[DRIVER UNIT]

REF NO.	PARTS NO.	DESCRIPTION	M.	H/V LOCATION
Q504	1590003061	S.FET PD55015-E	T	20/9.7
R102	7070000271	RES ERG1SJ 101 (100)		
C101	4030004750	S.CER C2012 JB 1H 103K-T	T	24.6/18.2
C102	4030011230	S.CER GRM31M2C2H390JV01L (GRM42-6 CH)	T	11.2/4.2
J101	6910016830	CON IMSA-9230B-1-04Z149-PT1		
J102	6910016830	CON IMSA-9230B-1-04Z149-PT1		
J103	6910016830	CON IMSA-9230B-1-04Z149-PT1		
J104	6910016830	CON IMSA-9230B-1-04Z149-PT1		
J107	6910016830	CON IMSA-9230B-1-04Z149-PT1		
MP1	8410002480	S.HEA 2429 PA HEATSINK	B	20/9.7

[DISPLAY UNIT]

REF NO.	PARTS NO.	DESCRIPTION	M.	H/V LOCATION
IC1	6910016730	S.DC XC9504B092ARN	B	44.4/9.4
IC101	1180001071	S.IC TA7805F(TE16L,Q)	B	90.3/6.9
IC151	1180002201	S.IC RN5RZ33BA-TR-F	B	99.9/4.8
IC301	1110002751	S.IC TA75S01F(E85R,F)	B	113.8/7.5
IC506	1120003010	S.IC AN2533FH-V	B	69/38.5
IC651	1110005420	S.IC BA15532F-E2	B	4.1/25.6
IC2003	1140013140	S.IC HD64338020SB68HV(SX-2427C)	B	93/26.3
IC2007	1110005821	S.IC R3112N281A-TR-F	B	108.7/46.9
Q1	1550000090	S.FET RSQ035P03TR	B	39.4/9.8
Q51	1560001330	S.FET RSR025N03	B	52.1/10.6
Q301	1560001290	S.FET 2SK3065 T100	T	110.8/31.4
Q302	1590003940	S.TRA RN1105(TE85L,F)	T	116.7/10.2
Q303	1590003930	S.TRA UMD22N TR	T	113.1/11.5
Q651	1590001650	S.TRA XP4601(X)	B	10.6/28.8
Q652	1590001650	S.TRA XP4601(X)	B	11.1/20.6
Q653	1590001650	S.TRA XP4601(X)	B	10.6/26.2
Q654	1590001650	S.TRA XP4601(X)	B	11.1/17
Q701	1530002060	S.TRA 2SC4081 T106 R	T	19.1/50.3
Q721	1530002060	S.TRA 2SC4081 T106 R	T	22/5.8
Q741	1530002060	S.TRA 2SC4081 T106 R	T	94/50.1
Q761	1530002060	S.TRA 2SC4081 T106 R	T	104.2/50.1
Q771	1530002060	S.TRA 2SC4081 T106 R	T	18.4/25.1
Q781	1530002060	S.TRA 2SC4081 T106 R	T	5.3/23.6
Q802	1520000460	S.TRA 2SB1132 T100 R	B	58.8/21.6
Q851	1590002771	S.FET CPH3404-TL-E	B	39.9/18.4
Q2001	1590003940	S.TRA RN1105(TE85L,F)	B	81.6/23.7
Q2002	1590001870	S.TRA DTA114EE TL	B	80.1/29.7
Q2003	1590003480	S.TRA DTC114TE TL	B	82.2/32.3
D1	1790000970	S.DIO MA729(TX)	B	36.8/10.1
D51	1750000730	S.DIO MA2SD1000L	B	51/8
D301	1790001250	S.DIO MA2S111-(TX)	B	111/32
D302	1790001520	S.ZEN MA8075-L(TX)	B	109.9/7.6
D601	1750000950	S.DIO MA732(TX)	B	51.5/39.8
D602	1750000950	S.DIO MA732(TX)	B	53.3/39.8
D801	1730002340	S.ZEN MA8047-M(TX)	B	35/40.4
D802	1730002340	S.ZEN MA8047-M(TX)	B	39.8/25.9
D803	1730002340	S.ZEN MA8047-M(TX)	B	39.5/22.8
D804	1730002340	S.ZEN MA8047-M(TX)	B	42/22.9
D2001	1750000950	S.DIO MA732(TX)	T	107.4/26.5
D2002	1790001670	S.DIO RB706F-40T106	B	76.6/16.8
D2003	1790001670	S.DIO RB706F-40T106	T	116.4/36.7
D2004	1750000370	S.DIO DA221 TL	T	100.6/41.8
D2005	1750000370	S.DIO DA221 TL	B	101.7/42.8
D2006	1750000370	S.DIO DA221 TL	B	107.3/5.9
X501	6050012150	S.XTA CR-806 SMD-49TA 4.433619 MHz [EUR]	B	87/43.5
	6050012150	S.XTA CR-806 SMD-49TA 4.433619 MHz [FRA]		
	6050012150	S.XTA CR-806 SMD-49TA 4.433619 MHz [ESP]		
	6050012140	S.XTA CR-805 SMD-49TA 3.579545 MHz [USA]		
	6050012150	S.XTA CR-806 SMD-49TA 4.433619 MHz [EXP]		
	6050012150	S.XTA CR-806 SMD-49TA 4.433619 MHz [ITR]		
	6050012150	S.XTA CR-806 SMD-49TA 4.433619 MHz [UK]		
	6050012140	S.XTA CR-805 SMD-49TA 3.579545 MHz [KOR]		
	6050012150	S.XTA CR-806 SMD-49TA 4.433619 MHz [AUS]		
	6050012150	S.XTA CR-806 SMD-49TA 4.433619 MHz [CHN]		
X2001	6050011550	S.XTA CR-747 SMD-49TA 9.8304 MHz	B	106.5/27
L1	6190001561	S.COI CDRH5D18NP-101NC	B	68.4/6.3
L2	6190001561	S.COI CDRH5D18NP-101NC	B	34.6/5.2
L3	6200002041	S.COI NLV25T-101J	B	30.7/10.4
L51	6190001561	S.COI CDRH5D18NP-101NC	B	55.9/6.2
L53	6200002041	S.COI NLV25T-101J	B	60.9/10.9
L101	6200001831	S.COI NLV32T-100J	B	96/11.6
L151	6200001831	S.COI NLV32T-100J	B	96/8.6
L152	6200001831	S.COI NLV32T-100J	B	100.6/11.4
L251	6200003950	S.COI HF50ACC 322513-T	B	145.8/44
L252	6200003950	S.COI HF50ACC 322513-T	B	145.2/50.9
L301	6200002041	S.COI NLV25T-101J	B	109.6/16.7
L302	6200005011	S.COI NLV25T-100J	T	112.6/24
L303	6200002041	S.COI NLV25T-101J	T	112/20.3
L306	6200003261	S.COI NLV32T-101J	T	109.8/25.5
L307	6200002041	S.COI NLV25T-101J	T	115.4/26.6
L309	6200002041	S.COI NLV25T-101J	T	115.3/24
L310	6200002041	S.COI NLV25T-101J	T	115.4/21.5
L312	6200002041	S.COI NLV25T-101J	T	115.4/19
L313	6200002041	S.COI NLV25T-101J	T	115.7/16.3
L505	6200005521	S.COI NLV25T-470J	B	71.2/47.9
L506	6200005011	S.COI NLV25T-100J	B	67.9/20.2
L507	6200005011	S.COI NLV25T-100J	B	50.2/29
L508	6200005011	S.COI NLV25T-100J	B	49.3/24.3
L509	6200005011	S.COI NLV25T-100J	B	17.4/35.6

M.=Mounted side (T: Mounted on the Top side, B: Mounted on the Bottom side)
S.=Surface mount

[DISPLAY UNIT]

REF NO.	PARTS NO.	DESCRIPTION	M.	H/V LOCATION
L601	6200002041	S.COI NLV25T-101J	B	70.6/25.2
L602	6200005011	S.COI NLV25T-100J	B	53.5/36.2
L603	6200005011	S.COI NLV25T-100J	B	51.4/43.3
L604	6200005011	S.COI NLV25T-100J	B	53.5/43.3
L605	6200005011	S.COI NLV25T-100J	B	50.9/36.2
L651	6200002041	S.COI NLV25T-101J	B	19.1/42.7
L701	6200002041	S.COI NLV25T-101J	B	21.1/37.5
L702	6200002041	S.COI NLV25T-101J	B	65.4/10.9
L703	6200002041	S.COI NLV25T-101J	B	27.9/11.3
L801	6200005011	S.COI NLV25T-100J	B	63.4/16.9
L802	6200002041	S.COI NLV25T-101J	B	19.1/47.5
L851	6200003950	S.COI HF50ACC 322513-T	B	33.2/17.2
L852	6200003950	S.COI HF50ACC 322513-T	B	35/21.3
L853	6200002041	S.COI NLV25T-101J	B	34.4/26.6
L854	6200002041	S.COI NLV25T-101J	B	34.4/24.1
L855	6200003950	S.COI HF50ACC 322513-T	B	36.4/17.2
R1	7030008141	S.RES ERA3YKD 224V (220K)	B	33.4/9.6
R2	7030005671	S.RES ERA3YKD 393V (39K)	B	33.4/11.6
R3	7030008051	S.RES ERA3YKD 184V (180K)	B	42.6/6.4
R4	7030005050	S.RES ERJ2GEJ 103 X (10K)	B	40.9/6.8
R5	7030005050	S.RES ERJ2GEJ 103 X (10K)	B	40.9/7.7
R51	7030008141	S.RES ERA3YKD 224V (220K)	B	49.7/10.8
R52	7030007911	S.RES ERA3YKD 563V (56K)	B	48.5/10.8
R53	7030006561	S.RES ERA3YED 223V (22K)	B	46.5/11.8
R54	7030005050	S.RES ERJ2GEJ 103 X (10K)	B	47.9/8.4
R55	7030005050	S.RES ERJ2GEJ 103 X (10K)	B	48.8/8.4
R201	7030010040	S.RES ERJ2GEJ-JPW	B	109.6/38
R202	7030010040	S.RES ERJ2GEJ-JPW	B	109.6/39
R251	7030005120	S.RES ERJ2GEJ 102 X (1K)	B	136.5/49.6
R252	7030000300	S.RES MCR10EZJH 220 (221)	B	133.9/47.3
R253	7030000300	S.RES MCR10EZJH 220 (221)	B	141.3/51.5
R254	7030000300	S.RES MCR10EZJH 220 (221)	B	133.9/49
R255	7030000300	S.RES MCR10EZJH 220 (221)	T	142.6/51.4
R301	7030005120	S.RES ERJ2GEJ 102 X (1K)	B	113.2/32
R302	7030005050	S.RES ERJ2GEJ 103 X (10K)	T	114/30.4
R303	7030005120	S.RES ERJ2GEJ 102 X (1K)	B	111/33.4
R304	7030007300	S.RES ERJ2GEJ 332 X (3.3K)	B	111.9/33.4
R305	7030007300	S.RES ERJ2GEJ 332 X (3.3K)	B	113.2/32.9
R306	7030005120	S.RES ERJ2GEJ 102 X (1K)	T	114.9/11
R307	7030005050	S.RES ERJ2GEJ 103 X (10K)	B	111.3/8.4
R308	7030005230	S.RES ERJ2GEJ 334 X (330K)	B	113.8/5.3
R309	7030005310	S.RES ERJ2GEJ 124 X (120K)	B	112/5.3
R310	7030008010	S.RES ERJ2GEJ 123 X (12K)	B	110.2/5.3
R521	7030008370	S.RES ERJ2GEJ 561 X (560)	B	61.8/46.2
R522	7030010040	S.RES ERJ2GEJ-JPW	B	65.3/47.4
R523	7030010040	S.RES ERJ2GEJ-JPW	B	65.4/48.7
R524	7030010900	S.RES ERJ3GEYJ 750 V (75)	B	63.1/48.9
R528	7030010040	S.RES ERJ2GEJ-JPW	B	60.8/42.6
R529	7030005050	S.RES ERJ2GEJ 103 X (10K)	B	58.6/43.8
R530	7030005080	S.RES ERJ2GEJ 823 X (82K)	B	60.8/43.6
R531	7030009290	S.RES ERJ2GEJ 562 X (5.6K)	B	76.3/42.9
R532	7030005050	S.RES ERJ2GEJ 103 X (10K)	B	60.8/37.2
R533	7030010040	S.RES ERJ2GEJ-JPW	B	56.5/32.3
R534	7030010040	S.RES ERJ2GEJ-JPW	B	60.8/36
R536	7030010040	S.RES ERJ2GEJ-JPW	B	62.6/29
R537	7030010040	S.RES ERJ2GEJ-JPW	B	64.6/29
R538	7030010040	S.RES ERJ2GEJ-JPW	B	66.6/29
R539	7030005720	S.RES ERJ2GEJ 563 X (56K)	B	69.6/29
R540	7030010040	S.RES ERJ2GEJ-JPW	B	68.6/29
R541	7310004650	S.TRI EVM-2WSX80 B53 (502)	B	53.3/49.2
R544	7030010040	S.RES ERJ2GEJ-JPW	B	60.8/39.6
R545	7030005720	S.RES ERJ2GEJ 563 X (56K)	B	60.8/32
R546	7030010040	S.RES ERJ2GEJ-JPW	B	60.8/34
R547	7030010040	S.RES ERJ2GEJ-JPW	B	59.2/34.8
R548	7030010040	S.RES ERJ2GEJ-JPW	B	60.8/33
R549	7030010040	S.RES ERJ2GEJ-JPW	B	63.6/29
R550	7030010040	S.RES ERJ2GEJ-JPW	B	65.6/29
R551	7030010040	S.RES ERJ2GEJ-JPW	B	67.6/29
R553	7030010040	S.RES ERJ2GEJ-JPW	B	59.5/43.8
R601	7030008410	S.RES ERJ2GEJ 392 X (3.9K)	B	72.7/24.9
R602	7030008410	S.RES ERJ2GEJ 392 X (3.9K)	B	74.5/24.9
R603	7030008410	S.RES ERJ2GEJ 392 X (3.9K)	B	75.4/24.9
R604	7030008410	S.RES ERJ2GEJ 392 X (3.9K)	B	77.2/24.9
R605	7030008410	S.RES ERJ2GEJ 392 X (3.9K)	B	75.3/30.2
R606	7030008410	S.RES ERJ2GEJ 392 X (3.9K)	B	76.3/24.9
R608	7030010040	S.RES ERJ2GEJ-JPW	B	48.8/36.8
R609	7030005040	S.RES ERJ2GEJ 472 X (4.7K)	B	48.4/44.4
R610	7030010040	S.RES ERJ2GEJ-JPW	B	48.8/41.7
R612	7030005040	S.RES ERJ2GEJ 472 X (4.7K)	B	48.8/42.6
R613	7030003470	S.RES ERJ3GEYJ 182 V (1.8K)	B	52.6/46.1
R614	7030003470	S.RES ERJ3GEYJ 182 V (1.8K)	B	50.7/46.3
R651	7030005050	S.RES ERJ2GEJ 103 X (10K)	B	5.5/19.6
R652	7030005220	S.RES ERJ2GEJ 223 X (22K)	B	0.8/25.7
R653	7030005060	S.RES ERJ2GEJ 333 X (33K)	B	5.5/21.4
R654	7030005070	S.RES ERJ2GEJ 683 X (68K)	B	0.8/23.9
R655	7030005090	S.RES ERJ2GEJ 104 X (100K)	B	4.1/30.7
R656	7030005110	S.RES ERJ2GEJ 224 X (220K)	B	0.8/27.4
R657	7030005060	S.RES ERJ2GEJ 333 X (33K)	B	1.8/30.3
R658	7030005090	S.RES ERJ2GEJ 104 X (100K)	B	4.1/29.8
R659	7030003600	S.RES ERJ3GEYJ 223 V (22K)	B	8.4/28.5
R660	7030005720	S.RES ERJ2GEJ 563 X (56K)	B	13.2/29.9
R661	7030005220	S.RES ERJ2GEJ 223 X (22K)	B	13.7/27.1
R662	7030007350	S.RES ERJ2GEJ 293 X (39K)	B	13.7/28.7
R663	7030005220	S.RES ERJ2GEJ 223 X (22K)	B	13.2/20.6
R664	7030007340	S.RES ERJ2GEJ 153 X (15K)	B	5.7/29.8

[DISPLAY UNIT]

REF NO.	PARTS NO.	DESCRIPTION	M.	H/V LOCATION
R665	7030003600	S.RES ERJ3GEYJ 223 V (22K)	B	8.9/20.6
R666	7030004980	S.RES ERJ2GEJ 101 X (100)	B	13.1/25.3
R667	7030004980	S.RES ERJ2GEJ 101 X (100)	B	11.1/18.8
R668	7030004980	S.RES ERJ2GEJ 101 X (100)	B	9.7/24.2
R669	7030004980	S.RES ERJ2GEJ 101 X (100)	B	13.6/16.2
R701	7030004990	S.RES ERJ2GEJ 221 X (220)	T	18.4/48
R702	7030007280	S.RES ERJ2GEJ 331 X (330)	T	19.7/48
R703	7030007290	S.RES ERJ2GEJ 222 X (2.2K)	T	25.1/41
R704	7030005040	S.RES ERJ2GEJ 472 X (4.7K)	T	16.6/17.2
R705	7030007340	S.RES ERJ2GEJ 153 X (15K)	T	18.7/6.4
R721	7030004990	S.RES ERJ2GEJ 221 X (220)	T	20.2/6.9
R722	7030007280	S.RES ERJ2GEJ 331 X (330)	T	23.8/5.6
R723	7030003480	S.RES ERJ3GEYJ 222 V (2.2K)	T	47.5/2.4
R724	7030003520	S.RES ERJ3GEYJ 472 V (4.7K)	T	61.8/2.4
R725	7030003580	S.RES ERJ3GEYJ 153 V (15K)	T	75.9/2.4
R741	7030004990	S.RES ERJ2GEJ 221 X (220)	T	92.2/49.7
R742	7030007280	S.RES ERJ2GEJ 331 X (330)	T	95.7/49.6
R743	7030007290	S.RES ERJ2GEJ 222 X (2.2K)	T	102.1/35
R744	7030005040	S.RES ERJ2GEJ 472 X (4.7K)	T	102.1/25.5
R745	7030007340	S.RES ERJ2GEJ 153 X (15K)	T	100.6/8.6
R761	7030004990	S.RES ERJ2GEJ 221 X (220)	T	103.1/48.2
R762	7030007280	S.RES ERJ2GEJ 331 X (330)	T	104.8/47.8
R771	7030004990	S.RES ERJ2GEJ 221 X (220)	T	18.7/28.9
R772	7030007280	S.RES ERJ2GEJ 331 X (330)	T	18.1/29.9
R781	7030004990	S.RES ERJ2GEJ 221 X (220)	T	3.5/22.4
R782	7030007280	S.RES ERJ2GEJ 331 X (330)	T	3.5/24.2
R801	7030005240	S.RES ERJ2GEJ 473 X (47K)	B	62/21.8
R802	7030007270	S.RES ERJ2GEJ 151 X (150)	B	62/20
R803	7030005120	S.RES ERJ2GEJ 102 X (1K)	B	62/23.6
R2002	7030005240	S.RES ERJ2GEJ 473 X (47K)	T	110.4/40.7
R2003	7030005050	S.RES ERJ2GEJ 103 X (10K)	T	24.6/24.1
R2004	7030005050	S.RES ERJ2GEJ 103 X (10K)	T	24.6/26.3
R2005	7030005050	S.RES ERJ2GEJ 103 X (10K)	T	24.6/23.2
R2006	7030005050	S.RES ERJ2GEJ 103 X (10K)	T	24.6/25.3
R2007	7030007290	S.RES ERJ2GEJ 222 X (2.2K)	T	107.6/24.4
R2008	7030005220	S.RES ERJ2GEJ 223 X (22K)	B	78.2/18.4
R2009	7030005240	S.RES ERJ2GEJ 473 X (47K)	T	107.8/33
R2010	7030005090	S.RES ERJ2GEJ 104 X (100K)	B	79.6/16.9
R2011	7030005160	S.RES ERJ2GEJ 105 X (1M)	B	103.3/26.9
R2012	7030008010	S.RES ERJ2GEJ 123 X (12K)	B	103.3/23.3
R2013	7030005240	S.RES ERJ2GEJ 473 X (47K)	B	96.7/37.9
R2014	7030005290	S.RES ERJ2GEJ 682 X (6.8K)	T	24.1/41
R2015	7030005050	S.RES ERJ2GEJ 103 X (10K)	B	106/44.6
R2016	7030005240	S.RES ERJ2GEJ 473 X (47K)	B	92.1/37.9
R2017	7030005290	S.RES ERJ2GEJ 682 X (6.8K)	T	33.4/3.7
R2018	7030005290	S.RES ERJ2GEJ 682 X (6.8K)	T	102.2/41.8
R2019	7030005240	S.RES ERJ2GEJ 473 X (47K)	B	84.8/33.8
R2020	7030003450	S.RES ERJ3GEYJ 122 V (1.2K)	B	91.2/43.1
R2021	7030005240	S.RES ERJ2GEJ 473 X (47K)	B	97.1/40.8
R2022	7030005240	S.RES ERJ2GEJ 473 X (47K)	B	92.3/42.3
R2023	7030005240	S.RES ERJ2GEJ 473 X (47K)	B	100.1/42.8
R2024	7030005240	S.RES ERJ2GEJ 473 X (47K)	B	94.3/42.3
R2025	7030005240	S.RES ERJ2GEJ 473 X (47K)	B	93.3/42.3
R2026	7030005240	S.RES ERJ2GEJ 473 X (47K)	B	72.4/16.3
R2027	7030005240	S.RES ERJ2GEJ 473 X (47K)	B	70.6/16.9
R2028	7030005240	S.RES ERJ2GEJ 473 X (47K)	B	98.9/42.8
R2029	7030005240	S.RES ERJ2GEJ 473 X (47K)	B	73.5/16.7
R2030	7030007270	S.RES ERJ2GEJ 151 X (150)	T	108/11.8
R2031	7030007280	S.RES ERJ2GEJ 331 X (330)	T	108.8/40.1
R2033	7030007270	S.RES ERJ2GEJ 151 X (150)	T	19.4/20.3
R2034	7030005120	S.RES ERJ2GEJ 102 X (1K)	B	32.1/28.3
R2035	7030005120	S.RES ERJ2GEJ 102 X (1K)	B	32.5/30.9
R2036	7030005240	S.RES ERJ2GEJ 473 X (47K)	B	94.9/37.9
R2037	7030005240	S.RES ERJ2GEJ 473 X (47K)	B	93.9/37.9
R2039	7030005240	S.RES ERJ2GEJ 473 X (47K)	T	107.6/23.5
R2040	7030007340	S.RES ERJ2GEJ 153 X (15K)	B	116.3/8.7
R2041	7030007340	S.RES ERJ2GEJ 153 X (15K)	B	116.2/7.7
R2042	7030005050	S.RES ERJ2GEJ 103 X (10K)	B	79.7/31.3
R2043	7030005090	S.RES ERJ2GEJ 104 X (100K)	B	81.9/30.4
C2	4030018960	S.CER C3216 JB 1C 106MT-N	B	62.2/7
C3	4030018960	S.CER C3216 JB 1C 106MT-N	B	77/9.8
C4	4030017420	S.CER ECJ0EC1H470J	B	35.3/10.6
C6	4030018960	S.CER C3216 JB 1C 106MT-N	B	28/6
C8	4030018960	S.CER C3216 JB 1C 106MT-N	B	30.1/6
C9	4030018960	S.CER C3216 JB 1C 106MT-N	B	39.1/4.4
C51	4030017420	S.CER ECJ0EC1H470J	B	49.7/8.8
C53	4030018960	S.CER C3216 JB 1C 106MT-N	B	5.6/4.3
C55	4030018960	S.CER C3216 JB 1C 106MT-N	B	51.6/21
C56	4030018960	S.CER C3216 JB 1C 106MT-N	B	61.9/3.6
C57	4030017490	S.CER C1608 JB 1A 105K-T	B	43.9/11.8
C101	4030018960	S.CER C3216 JB 1C 106MT-N	B	85.7/6.3
C102	4030018960	S.CER C3216 JB 1C 106MT-N	B	94.7/4.6
C103	4030016930	S.CER ECJ0EB1A104K	B	91.1/12.2
C104	4030016930	S.CER ECJ0EB1A104K	B	89.5/12.2
C151	4550006250	S.TAN TEESVA 1A 106M8R	B	97/4.6
C152	4550006250	S.TAN TEESVA 1A 106M8R	B	100.7/7.7
C153	4030016930	S.CER ECJ0EB1A104K	B	99.7/2.6
C154	4030016930	S.CER ECJ0EB1A104K	B	99.6/9.3
C251	4030017730	S.CER ECJ0EB1E471K	B	1

[DISPLAY UNIT]

REF NO.	PARTS NO.	DESCRIPTION	M.	H/V LOCATION
C302	4030017780	S.CER ECJ0EB1E472K	T	108.2/28.7
C303	4030006880	S.CER C1608 JB 1H 472K-T	T	113/27
C304	4030017780	S.CER ECJ0EB1E472K	B	113.2/33.8
C305	4030017780	S.CER ECJ0EB1E472K	T	114.9/12.6
C306	4030017780	S.CER ECJ0EB1E472K	B	113.8/4.3
C312	4030017780	S.CER ECJ0EB1E472K	T	108.2/29.6
C315	4030017780	S.CER ECJ0EB1E472K	B	25.2/19.9
C316	4030017780	S.CER ECJ0EB1E472K	B	26.1/19.9
C317	4030017780	S.CER ECJ0EB1E472K	B	27/19.9
C318	4030017780	S.CER ECJ0EB1E472K	B	23.9/19.8
C319	4030017780	S.CER ECJ0EB1E472K	B	27.2/32.5
C320	4030017780	S.CER ECJ0EB1E472K	B	26.3/32.5
C321	4030017780	S.CER ECJ0EB1E472K	B	25.5/31.1
C322	4030017780	S.CER ECJ0EB1E472K	T	24.6/27.3
C501	4550007140	S.TAN TEESVD 1C 107M12R	B	53.3/20.9
C502	4550007140	S.TAN TEESVD 1C 107M12R	B	45.3/20.9
C513	4030016930	S.CER ECJ0EB1A104K	B	64.3/47.4
C514	4030016930	S.CER ECJ0EB1A104K	B	63.3/47.4
C515	4030017490	S.CER C1608 JB 1A 105K-T	B	61.5/44.9
C516	4030018910	S.CER C1608 JB 0J 475K-T	B	67.7/48.9
C517	4030017490	S.CER C1608 JB 1A 105K-T	B	75.6/47.9
C518	4030017650	S.CER ECJ0EC1H270J	[EUR] B	73.4/47.4
	4030017650	S.CER ECJ0EC1H270J	[FRA]	
	4030017650	S.CER ECJ0EC1H270J	[ESP]	
	4030017670	S.CER ECJ0EC1H390J	[USA]	
	4030017650	S.CER ECJ0EC1H270J	[EXP]	
	4030017650	S.CER ECJ0EC1H270J	[ITR]	
	4030017650	S.CER ECJ0EC1H270J	[UK]	
	4030017670	S.CER ECJ0EC1H390J	[KOR]	
	4030017650	S.CER ECJ0EC1H270J	[AUS]	
	4030017650	S.CER ECJ0EC1H270J	[CHN]	
C519	4030016930	S.CER ECJ0EB1A104K	B	76.9/48.4
C520	4030016930	S.CER ECJ0EB1A104K	B	74.4/47.4
C521	4030018960	S.CER C3216 JB 1C 106MT-N	B	65.6/20.6
C522	4030016930	S.CER ECJ0EB1A104K	B	69.7/19.8
C523	4030018970	S.CER C3225 JB 1C 226MT-N	B	53.4/28.9
C524	4030017700	S.CER ECJ0EC1H151J	B	59/42.6
C525	4030016930	S.CER ECJ0EB1A104K	B	55.4/30.3
C526	4030018090	S.CER ECJ0EB1C822K	B	59.2/35.8
C527	4030018100	S.CER ECJ0EB1H681K	B	59/45.9
C528	4030017730	S.CER ECJ0EB1E471K	B	59/45.9
C529	4030018970	S.CER C3225 JB 1C 226MT-N	B	58.4/40
C530	4030016930	S.CER ECJ0EB1A104K	B	77.2/39.1
C531	4030018970	S.CER C3225 JB 1C 226MT-N	B	81.3/35.9
C532	4030016930	S.CER ECJ0EB1A104K	B	77.2/36.6
C533	4030017490	S.CER C1608 JB 1A 105K-T	B	77/44.5
C534	4030016970	S.CER ECJ0EB1C223K	B	77.5/42.5
C536	4610001850	S.TRI TZB4R200AB10R00 (TZB4R200BA110)	B	81/39.7
C537	4030016930	S.CER ECJ0EB1A104K	B	77.2/40.1
C538	4030016930	S.CER ECJ0EB1A104K	B	77.2/37.6
C539	4030018910	S.CER C1608 JB 0J 475K-T	B	77.7/34.9
C540	4030018910	S.CER C1608 JB 0J 475K-T	B	58.5/37
C541	4030018970	S.CER C3225 JB 1C 226MT-N	B	59.2/28.9
C542	4030018910	S.CER C1608 JB 0J 475K-T	B	77.7/33.6
C543	4030018960	S.CER C3216 JB 1C 106MT-N	B	80/46.5
C544	4030018910	S.CER C1608 JB 0J 475K-T	B	77.7/32.3
C545	4030011600	S.CER C1608 JB 1E 104K-T	B	77/46.3
C549	4030018960	S.CER C3216 JB 1C 106MT-N	B	71.7/28.8
C550	4030018960	S.CER C3216 JB 1C 106MT-N	B	77/28.8
C551	4030018960	S.CER C3216 JB 1C 106MT-N	B	73.8/28.8
C559	4030017460	S.CER ECJ0EB1E102K	B	29.3/43.9
C560	4030018960	S.CER C3216 JB 1C 106MT-N	B	17/33.2
C561	4030017330	S.CER ECJ0EF1C104Z	B	7.3/30.7
C562	4030017780	S.CER ECJ0EB1E472K	B	6.1/30.9
C601	4030016930	S.CER ECJ0EB1A104K	B	73.6/24.9
C602	4030016930	S.CER ECJ0EB1A104K	B	48.8/43.5
C603	4030016930	S.CER ECJ0EB1A104K	B	55/39.4
C604	4030018960	S.CER C3216 JB 1C 106MT-N	B	55.8/36.3
C605	4030016930	S.CER ECJ0EB1A104K	B	50.9/48
C606	4030018960	S.CER C3216 JB 1C 106MT-N	B	49/47.4
C607	4030011600	S.CER C1608 JB 1E 104K-T	B	55.4/40.6
C608	4030018960	S.CER C3216 JB 1C 106MT-N	B	55.8/43.7
C609	4030011600	S.CER C1608 JB 1E 104K-T	B	50.6/31.7
C610	4030018960	S.CER C3216 JB 1C 106MT-N	B	52.3/33.5
C611	4550007220	S.TAN F931A476MCMBMA	B	73.4/22.1
C651	4030018960	S.CER C3216 JB 1C 106MT-N	B	16.9/17.6
C652	4030018960	S.CER C3216 JB 1C 106MT-N	B	6.7/17.1
C653	4030011600	S.CER C1608 JB 1E 104K-T	B	15.7/19.3
C654	4030017490	S.CER C1608 JB 1A 105K-T	B	3.5/20.4
C655	4030016790	S.CER ECJ0EB1C103K	B	0.8/30.3
C656	4030019090	S.CER C2012 JB 1C 225M-T	B	7.8/25.5
C657	4030018520	S.CER C1608 JB 0J 225M-T	B	7/20.6
C658	4030017650	S.CER ECJ0EC1H270J	B	5.5/20.5
C659	4030017780	S.CER ECJ0EB1E472K	B	15.2/20.3
C701	4030018960	S.CER C3216 JB 1C 106MT-N	B	4.6/32.4
C702	4030018960	S.CER C3216 JB 1C 106MT-N	B	48.9/19
C801	4030016930	S.CER ECJ0EB1A104K	B	62.9/19.7
C802	4030011600	S.CER C1608 JB 1E 104K-T	B	21.5/48.5
C851	4030017780	S.CER ECJ0EB1E472K	B	32.1/23.9
C852	4030018960	S.CER C3216 JB 1C 106MT-N	B	40.3/15.8
C853	4030016930	S.CER ECJ0EB1A104K	B	43.1/27.5
C2001	4030018520	S.CER C1608 JB 0J 225M-T	B	78.5/16.7
C2002	4030017780	S.CER ECJ0EB1E472K	T	114.8/34.7
C2003	4030017630	S.CER ECJ0EC1H120J	B	103.3/28.7
C2004	4030017630	S.CER ECJ0EC1H120J	B	103.3/25.1
C2005	4030016790	S.CER ECJ0EB1C103K	B	103.2/34.9

[DISPLAY UNIT]

REF NO.	PARTS NO.	DESCRIPTION	M.	H/V LOCATION
C2006	4030016930	S.CER ECJ0EB1A104K	B	98/37.9
C2007	4030018960	S.CER C3216 JB 1C 106MT-N	B	105.8/47.7
C2008	4030017030	S.CER ECJ0EB1A273K	B	109.7/44.6
C2009	4030016930	S.CER ECJ0EB1A104K	B	99/37.9
C2010	4030016930	S.CER ECJ0EB1A104K	B	100/37.9
C2011	4030016930	S.CER ECJ0EB1A104K	B	78.7/29.9
C2012	4030017780	S.CER ECJ0EB1E472K	B	95.8/37.9
C2013	4030017780	S.CER ECJ0EB1E472K	B	93/37.9
C2014	4030016930	S.CER ECJ0EB1A104K	T	110.4/41.7
C2015	4030016930	S.CER ECJ0EB1A104K	B	103.1/35.8
C2016	4030016930	S.CER ECJ0EB1A104K	B	82.7/28.4
J202	6510023801	S.CON S4B-ZR-SM4A-TF(LF)(SN)	B	115.9/39.4
J251	6510025770	S.CON 03-935H0-72BKA	B	154.2/45.8
J303	6510021431	S.CON S8B-ZR-SM4A-TF(LF)(SN)	B	115.9/20.9
J401	6510024840	S.CON 52746-1070	B	21.3/26.3
J601	6510024780	S.CON 52437-2472	B	45.1/42
J2001	6510024790	S.CON 52559-1072	B	96.9/47.6
DS805	5040003190	S.LED NSSW008B	T	29.5/39.4
DS806	5040003190	S.LED NSSW008B	T	29.4/31.4
DS807	5040003190	S.LED NSSW008B	T	29.4/24.1
DS808	5040003190	S.LED NSSW008B	T	29.5/16.1
DS2001	5040002030	S.LED SML-512MW T86	T	110.2/15.8
DS2002	5040002020	S.LED CL-170UR-CD-T	T	110.2/36.8
DS2004	5040002930	S.LED SML-512MW T86	T	11.4/20.5
S201	2230001160	S.SWI SPVP110100	T	157.4/34.3
S251	2220000330	S.SWI HSW0880-01-210	B	139.7/46.5
S701	2230001150	S.SWI LS9J2M-1FG-T	T	22.2/48.3
S702	2230001150	S.SWI LS9J2M-1FG-T	T	21.7/36.5
S703	2230001150	S.SWI LS9J2M-1FG-T	T	20.9/17
S704	2230001150	S.SWI LS9J2M-1FG-T	T	21.6/2.7
S721	2230001150	S.SWI LS9J2M-1FG-T	T	40.1/2.4
S722	2230001150	S.SWI LS9J2M-1FG-T	T	54.3/2.4
S723	2230001150	S.SWI LS9J2M-1FG-T	T	68.4/2.4
S724	2230001150	S.SWI LS9J2M-1FG-T	T	82.6/2.4
S741	2230001150	S.SWI LS9J2M-1FG-T	T	98.1/47.8
S742	2230001150	S.SWI LS9J2M-1FG-T	T	99.1/32.1
S743	2230001150	S.SWI LS9J2M-1FG-T	T	99.1/20.5
S744	2230001150	S.SWI LS9J2M-1FG-T	T	98.1/5.7
S761	2230001150	S.SWI LS9J2M-1FG-T	T	109.5/49.1
S762	2230001150	S.SWI LS9J2M-1FG-T	T	109.5/3.5
S763	2230001150	S.SWI LS9J2M-1FG-T	T	154.8/47.4
S764	2230001150	S.SWI LS9J2M-1FG-T	T	154.8/5.1
S781	2230001150	S.SWI LS9J2M-1FG-T	T	4.6/29
S782	2230001150	S.SWI LS9J2M-1FG-T	T	21.7/25.8
EP1	6910014730	S.BEA MPZ2012S331A-T	B	64.1/6.6

M.=Mounted side (T: Mounted on the Top side, B: Mounted on the Bottom side)
S.=Surface mount

[VR UNIT]

REF NO.	PARTS NO.	DESCRIPTION	M.	H/V LOCATION
R1	7210003230	VAR TP96D00A-17F-10KBX2-2427		
R2	7030003860	S.RES ERJ3GE JPW V	T	1.3/32.6
R3	7030003860	S.RES ERJ3GE JPW V	T	2.3/30
J1	6510024850	S.CON 54550-1094	T	3.3/22.2
S1	2250000170	ENC TP90D96AE20-17F (1352)		
EP4	6910012350	S.BEA MMZ1608Y 102BT	T	2.7/32.6
EP5	6910012350	S.BEA MMZ1608Y 102BT	T	3.7/30
EP6	6910012350	S.BEA MMZ1608Y 102BT	T	0.9/30
EP7	6910012350	S.BEA MMZ1608Y 102BT	T	0.9/14.5
EP8	6910012350	S.BEA MMZ1608Y 102BT	T	3.7/14.5
EP9	6910012350	S.BEA MMZ1608Y 102BT	T	2.7/11.8
EP10	6910012350	S.BEA MMZ1608Y 102BT	T	2.3/14.5
EP11	6910012350	S.BEA MMZ1608Y 102BT	T	1.3/11.8

[LOGIC UNIT]

REF NO.	PARTS NO.	DESCRIPTION	M.	H/V LOCATION
IC1	1130013281	S.IC TC58FVM6T5BTG65GCH (SX2427D-6)	T	27.9/30.2
IC2	1130011151	S.IC SN74AHC2G08HDCT3	B	40.2/38.2
IC3	1130011151	S.IC SN74AHC2G08HDCT3	B	40.6/32.4
IC4	1130012600	S.IC SN74AHC1G04DCKR	B	43.6/33.8
IC51	1130012842	S.IC CY7C1021DV33-10BVXIT	B	24.5/28.5
IC301	1140012541	S.IC ADSP-BF532SBBCZ400	B	28.6/39.2
IC401	1110004770	S.IC BU9480F-E2	B	17.4/21.6
IC451	1110006570	S.IC TS462CPT	B	29.1/7.9
IC452	1110006570	S.IC TS462CPT	T	39.1/8.5
IC502	1110006570	S.IC TS462CPT	T	30.7/5.4
IC551	1190001611	S.IC AK4528VFP-E2/P	T	17.9/8.1
IC601	1110006570	S.IC TS462CPT	B	12.7/10.8
IC701	1130012600	S.IC SN74AHC1G04DCKR	B	2.7/15.9
IC1201	1130012791	S.IC CY22150FZXCT	B	44.5/4.5
IC1212	1140012170	S.IC BH7236AF-E2	T	57.7/7.3
IC1217	1130007181	S.IC TC7WU04FU(TE12L,F)	B	63.4/9.8
IC1218	1130012761	S.IC SN74AHC2G86HDCT3	B	52.7/6.5
IC1226	1130010871	S.IC S1D13706F00A200	B	53.7/19.8
IC1251	1180002020	S.REG BA033FP-E2	T	79.5/5.2
IC1301	1130012691	S.IC R1EX24256ASA00A	T	81.4/36.2
IC1302	1140013137	S.IC HD6432375A23FQV(SX-2427B-7)	T	54.9/25.2
IC1303	1110005771	S.IC S-80942CNMC-G9CT2G	T	81.2/10.4
IC1304	1130011551	S.IC RX-4581NB-F	B	71.9/7.2
IC1402	1130012781	S.IC SN74AHC2G04HDCT3	T	79.1/18.9
IC2002	1130012842	S.IC CY7C1021DV33-10BVXIT	B	32.7/28.3
IC2101	1130012850	S.IC SN74LVC3G34DCUR	T	44.5/44.7
IC2102	1130012850	S.IC SN74LVC3G34DCUR	T	44.4/41.2
IC2201	1140012541	S.IC ADSP-BF532SBBCZ400	B	28.6/17.7
Q201	1550000110	S.FET RTQ035P02TR	B	18.9/42.7
Q1101	1530002060	S.TRA 2SC4081 T106 R	T	82.1/20.3
Q1102	1590003940	S.TRA RN1105(TE85L,F)	T	81.8/22.7
Q1103	1510000510	S.TRA 2SA1576A T106R	T	81.8/16.4
Q1201	1590003940	S.TRA RN1105(TE85L,F)	T	44.8/13.2
D201	1750001280	S.DIO CUS02(TE85L,Q)	B	19.2/45.3
D1001	1750000370	S.DIO DA221 TL	B	64.5/36.8
D1002	1750000370	S.DIO DA221 TL	B	64.9/34.5
D1101	1790001250	S.DIO MA2S111-(TX)	T	81.9/18.4
D1106	1750000950	S.DIO MA732(TX)	T	80.1/29.6
D1107	1790001670	S.DIO RB706F-40T106	T	82.4/31.3
D1110	1790001670	S.DIO RB706F-40T106	T	75.7/32.3
D1111	1790001670	S.DIO RB706F-40T106	T	75.3/29.3
D1112	1790001670	S.DIO RB706F-40T106	B	79.2/29.1
D1113	1790001670	S.DIO RB706F-40T106	B	82.3/30.6
D1201	1790001250	S.DIO MA2S111-(TX)	B	83/40.4
D1301	1790000660	S.DIO MA728(TX)	B	77.5/2.9
D1304	1750000370	S.DIO DA221 TL	T	76.1/19.9
D1305	1750000370	S.DIO DA221 TL	T	75.8/16.8
D1306	1750000370	S.DIO DA221 TL	B	49.3/32.9
D1307	1750000370	S.DIO DA221 TL	B	51.4/33.3
D1311	1790001250	S.DIO MA2S111-(TX)	B	80.9/19.6
D1312	1790001250	S.DIO MA2S111-(TX)	B	83.1/18.5
D1313	1790001250	S.DIO MA2S111-(TX)	B	80/22.6
D1314	1790001240	S.DIO MA2S728-(TX)	B	81.7/22.4
D1331	1790001250	S.DIO MA2S111-(TX)	B	65.6/17.5
X1201	6050012150	S.XTA CR-806 SMD-49TA 4.433619 MHz [EUR]	B	61.3/3.1
	6050012150	S.XTA CR-806 SMD-49TA 4.433619 MHz [FRA]		
	6050012150	S.XTA CR-806 SMD-49TA 4.433619 MHz [ESP]		
	6050012140	S.XTA CR-805 SMD-49TA 3.579545 MHz [USA]		
	6050012150	S.XTA CR-806 SMD-49TA 4.433619 MHz [EXP]		
	6050012150	S.XTA CR-806 SMD-49TA 4.433619 MHz [ITR]		
	6050012150	S.XTA CR-806 SMD-49TA 4.433619 MHz [UK]		
	6050012140	S.XTA CR-805 SMD-49TA 3.579545 MHz [KOR]		
	6050012150	S.XTA CR-806 SMD-49TA 4.433619 MHz [AUS]		
	6050012150	S.XTA CR-806 SMD-49TA 4.433619 MHz [CHN]		
X1301	6050012190	S.XTA CR-809 SMD-49TA 1539744 MHz	B	60.4/30.8
L201	6200011900	S.COI LQH43CN100K03L	T	16/41.9
L202	6200009491	S.COI CDRH6D28NP-100NC	B	13.3/42.3
L551	6200005011	S.COI NLV25T-100J	T	11.2/10.5
L552	6200005011	S.COI NLV25T-100J	T	11.1/5.8
L1202	6200002041	S.COI NLV25T-101J	B	52.3/2.3
L1203	6200002041	S.COI NLV25T-101J	T	66.7/3.5
L1204	6200002041	S.COI NLV25T-101J	B	57.9/10.3
L2101	6200005011	S.COI NLV25T-100J	T	40.9/45
L2102	6200005011	S.COI NLV25T-100J	T	40.2/41.5
R2	7030005090	S.RES ERJ2GEJ 104 X (100K)	T	39.5/30.1
R3	7030005090	S.RES ERJ2GEJ 104 X (100K)	T	39.5/32.3

M.=Mounted side (T: Mounted on the Top side, B: Mounted on the Bottom side)
S.=Surface mount

[LOGIC UNIT]

REF NO.	PARTS NO.	DESCRIPTION	M.	H/V LOCATION
R4	7030005090	S.RES ERJ2GEJ 104 X (100K)	T	31.8/45.8
R5	7030005090	S.RES ERJ2GEJ 104 X (100K)	T	30.9/45.8
R6	7030005090	S.RES ERJ2GEJ 104 X (100K)	T	30/45.8
R203	7030000010	S.RES MCR10EZHJ JPW (000)	T	20.7/45.6
R301	7030004980	S.RES ERJ2GEJ 101 X (100)	T	25.4/45.8
R302	7030005050	S.RES ERJ2GEJ 103 X (10K)	T	26.9/45.8
R303	7030005050	S.RES ERJ2GEJ 103 X (10K)	T	27.8/45.8
R306	7030005050	S.RES ERJ2GEJ 103 X (10K)	B	38.1/31.1
R307	7030005050	S.RES ERJ2GEJ 103 X (10K)	T	22/41.4
R308	7030005050	S.RES ERJ2GEJ 103 X (10K)	T	22/40.5
R310	7030005050	S.RES ERJ2GEJ 103 X (10K)	B	35.3/38
R312	7030010040	S.RES ERJ2GEJ-JPW	B	33.6/45.9
R313	7030010040	S.RES ERJ2GEJ-JPW	B	35.6/43.3
R314	7030010040	S.RES ERJ2GEJ-JPW	B	35.6/40.6
R413	7030004980	S.RES ERJ2GEJ 101 X (100)	B	18.1/16.8
R414	7030004980	S.RES ERJ2GEJ 101 X (100)	T	16.3/19.9
R415	7030004980	S.RES ERJ2GEJ 101 X (100)	B	19/16.8
R416	7030004980	S.RES ERJ2GEJ 101 X (100)	B	17.2/16.8
R462	7030004980	S.RES ERJ2GEJ 101 X (100)	B	33.8/7.4
R463	7030004980	S.RES ERJ2GEJ 101 X (100)	T	43.6/8.8
R464	7030004980	S.RES ERJ2GEJ 101 X (100)	B	26.2/5.7
R465	7030009270	S.RES ERJ2GEJ 821 X (820)	B	28.6/5.2
R467	7030004980	S.RES ERJ2GEJ 101 X (100)	B	31.3/4.3
R469	7030009270	S.RES ERJ2GEJ 821 X (820)	B	30.4/4.3
R470	7030009140	S.RES ERJ2GEJ 272 X (2.7K)	T	29.4/3
R471	7030009140	S.RES ERJ2GEJ 272 X (2.7K)	T	34/3.3
R472	7030005040	S.RES ERJ2GEJ 472 X (4.7K)	T	38.6/4.2
R473	7030005040	S.RES ERJ2GEJ 472 X (4.7K)	T	38.6/3.2
R474	7030009140	S.RES ERJ2GEJ 272 X (2.7K)	B	24.8/7.1
R475	7030009140	S.RES ERJ2GEJ 272 X (2.7K)	B	33.8/9.2
R476	7030005040	S.RES ERJ2GEJ 472 X (4.7K)	T	40.2/3.3
R507	7030004980	S.RES ERJ2GEJ 101 X (100)	T	26/3.5
R508	7030004980	S.RES ERJ2GEJ 101 X (100)	T	31.6/8.9
R510	7030005040	S.RES ERJ2GEJ 472 X (4.7K)	T	32.5/8.9
R511	7030005040	S.RES ERJ2GEJ 472 X (4.7K)	T	28.9/8.9
R512	7030004980	S.RES ERJ2GEJ 101 X (100)	T	29.8/8.9
R514	7030005050	S.RES ERJ2GEJ 103 X (10K)	T	34.9/8.8
R515	7030005050	S.RES ERJ2GEJ 103 X (10K)	T	34.7/9.7
R516	7030005040	S.RES ERJ2GEJ 472 X (4.7K)	T	39/12.8
R517	7030005040	S.RES ERJ2GEJ 472 X (4.7K)	T	36.5/11
R518	7030009140	S.RES ERJ2GEJ 272 X (2.7K)	T	36.4/5.6
R519	7030009140	S.RES ERJ2GEJ 272 X (2.7K)	T	26.4/5.6
R520	7030005040	S.RES ERJ2GEJ 472 X (4.7K)	T	41.3/12.8
R551	7030004980	S.RES ERJ2GEJ 101 X (100)	T	16.5/13.4
R553	7030004980	S.RES ERJ2GEJ 101 X (100)	T	14.7/13.4
R554	7030005090	S.RES ERJ2GEJ 104 X (100K)	T	17.4/3.2
R568	7030004980	S.RES ERJ2GEJ 101 X (100)	T	12.9/13.4
R569	7030004980	S.RES ERJ2GEJ 101 X (100)	T	15.6/13.4
R570	7030004980	S.RES ERJ2GEJ 101 X (100)	T	13.8/13.4
R571	7030009320	S.RES ERJ2GEJ 4R7 X (4.7)	B	20.7/8.4
R601	7030004980	S.RES ERJ2GEJ 101 X (100)	T	3/12.3
R602	7030007300	S.RES ERJ2GEJ 332 X (3.3K)	T	11.8/8.4
R603	7030005040	S.RES ERJ2GEJ 472 X (4.7K)	B	12.3/4.8
R604	7030005040	S.RES ERJ2GEJ 472 X (4.7K)	B	23.3/4.8
R605	7030007300	S.RES ERJ2GEJ 332 X (3.3K)	B	14.4/5.1
R606	7030007300	S.RES ERJ2GEJ 332 X (3.3K)	B	12.8/7.2
R607	7030005290	S.RES ERJ2GEJ 682 X (6.8K)	B	13.8/7.2
R608	7030005290	S.RES ERJ2GEJ 682 X (6.8K)	B	14.8/6.4
R609	7030005040	S.RES ERJ2GEJ 472 X (4.7K)	T	10.9/8.4
R610	7030005040	S.RES ERJ2GEJ 472 X (4.7K)	B	8.9/4.2
R611	7030005040	S.RES ERJ2GEJ 472 X (4.7K)	B	9.8/4.2
R612	7030007300	S.RES ERJ2GEJ 332 X (3.3K)	B	11.4/5.6
R613	7030007300	S.RES ERJ2GEJ 332 X (3.3K)	B	8.8/6.9
R614	7030005290	S.RES ERJ2GEJ 682 X (6.8K)	B	9.7/6.9
R615	7030005290	S.RES ERJ2GEJ 682 X (6.8K)	B	10.6/6.9
R618	7030005120	S.RES ERJ2GEJ 102 X (1K)	B	14.4/4.2
R619	7030005120	S.RES ERJ2GEJ 102 X (1K)	B	10.7/4.2
R701	7030005050	S.RES ERJ2GEJ 103 X (10K)	B	4.6/22.8
R702	7030005050	S.RES ERJ2GEJ 103 X (10K)	B	4.6/23.7
R703	7030005050	S.RES ERJ2GEJ 103 X (10K)	B	4.5/25.9
R705	7030005120	S.RES ERJ2GEJ 102 X (1K)	B	5/21
R706	7030005050	S.RES ERJ2GEJ 103 X (10K)	B	4.4/17.1
R707	7030007250	S.RES ERJ2GEJ 220 X (22)	B	4.4/15.5
R1001	7030005120	S.RES ERJ2GEJ 102 X (1K)	B	70.8/37
R1002	7030005050	S.RES ERJ2GEJ 103 X (10K)	B	65.9/32.3
R1003	7030005160	S.RES ERJ2GEJ 105 X (1M)	B	70.4/35.8
R1004	7030005240	S.RES ERJ2GEJ 473 X (47K)	B	66.1/18.5
R1006	7030005120	S.RES ERJ2GEJ 102 X (1K)	B	52/34.8
R1007	7030005120	S.RES ERJ2GEJ 102 X (1K)	B	53.2/32
R1008	7030005120	S.RES ERJ2GEJ 102 X (1K)	B	75.1/20.4
R1010	7030005240	S.RES ERJ2GEJ 473 X (47K)	B	76.7/19.8
R1012	7030005000	S.RES ERJ2GEJ 471 X (470)	B	66.5/33.9
R1013	7030005000	S.RES ERJ2GEJ 471 X (470)	B	66.5/36.4
R1015	7030005240	S.RES ERJ2GEJ 473 X (47K)	B	50.4/34.8
R1016	7030005240	S.RES ERJ2GEJ 473 X (47K)	B	51/31.7
R1018	7030007340	S.RES ERJ2GEJ 153 X (15K)	B	63.3/34.4
R1019	7030007340	S.RES ERJ2GEJ 153 X (15K)	B	62.9/36.1
R1101	7030008290	S.RES ERJ2GEJ 183 X (18K)	T	80.1/15.4
R1102	7030008010	S.RES ERJ2GEJ 123 X (12K)	T	79.9/21.9
R1103	7030005120	S.RES ERJ2GEJ 102 X (1K)	T	79.9/22.8
R1104	7030005120	S.RES ERJ2GEJ 102 X (1K)	T	74.5/20.7
R1105	7030005050	S.RES ERJ2GEJ 103 X (10K)	T	79.6/14.2
R1106	7030005240	S.RES ERJ2GEJ 473 X (47K)	T	83.3/14.4
R1107	7030005090	S.RES ERJ2GEJ 104 X (100K)	T	79.2/15.4
R1108	7030005090	S.RES ERJ2GEJ 104 X (100K)	T	78.3/14.8
R1109	7030005160	S.RES ERJ2GEJ 105 X (1M)	T	78.3/21.9
R1110	7030005240	S.RES ERJ2GEJ 473 X (47K)	T	76.7/21.4

[LOGIC UNIT]

REF NO.	PARTS NO.	DESCRIPTION	M.	H/V LOCATION
R1111	7030005090	S.RES ERJ2GEJ 104 X (100K)	T	77.4/14.8
R1113	7030007290	S.RES ERJ2GEJ 22 X (2.2K)	T	83.2/29.3
R1114	7030007300	S.RES ERJ2GEJ 332 X (3.3K)	T	82.3/29.3
R1115	7030005120	S.RES ERJ2GEJ 102 X (1K)	T	76.8/26.3
R1116	7030005120	S.RES ERJ2GEJ 102 X (1K)	T	76.9/28.1
R1117	7030005120	S.RES ERJ2GEJ 102 X (1K)	B	82.7/22.2
R1118	7030007300	S.RES ERJ2GEJ 332 X (3.3K)	B	83/23.8
R1119	7030007300	S.RES ERJ2GEJ 332 X (3.3K)	B	83.8/22.2
R1120	7030005120	S.RES ERJ2GEJ 102 X (1K)	B	84.1/23.8
R1123	7030005160	S.RES ERJ2GEJ 105 X (1M)	B	66.9/24.4
R1124	7030005120	S.RES ERJ2GEJ 102 X (1K)	B	82/20
R1126	7030005160	S.RES ERJ2GEJ 105 X (1M)	B	66.9/23.5
R1127	7030010040	S.RES ERJ2GEJ-JPW	T	73.7/18.5
R1128	7030005120	S.RES ERJ2GEJ 102 X (1K)	B	83.2/20.1
R1129	7030007300	S.RES ERJ2GEJ 332 X (3.3K)	B	81.9/28.4
R1131	7030005090	S.RES ERJ2GEJ 104 X (100K)	B	78.5/26.1
R1132	7030005090	S.RES ERJ2GEJ 104 X (100K)	B	81.4/24.4
R1201	7030005160	S.RES ERJ2GEJ 105 X (1M)	B	62.7/7.6
R1202	7030005050	S.RES ERJ2GEJ 103 X (10K)	B	49.2/7.5
R1203	7030005050	S.RES ERJ2GEJ 103 X (10K)	B	49.2/8.4
R1204	7030005050	S.RES ERJ2GEJ 103 X (10K)	B	49.7/9.6
R1205	7030010040	S.RES ERJ2GEJ-JPW	B	49.2/3.1
R1206	7030007570	S.RES ERJ2GEJ 122 X (1.2K)	B	46.1/9.6
R1207	7030007570	S.RES ERJ2GEJ 122 X (1.2K)	B	43.9/9.6
R1208	7030007570	S.RES ERJ2GEJ 122 X (1.2K)	B	43.5/11.4
R1209	7030009710	S.RES ERJ2GEJ 203 X (20K)	B	48.8/9.6
R1210	7030007350	S.RES ERJ2GEJ 393 X (39K)	B	47.9/9.6
R1211	7030005050	S.RES ERJ2GEJ 103 X (10K)	B	48.9/11.4
R1212	7030005050	S.RES ERJ2GEJ 103 X (10K)	B	48/11.4
R1213	7030005050	S.RES ERJ2GEJ 103 X (10K)	B	47.1/11.4
R1214	7030009710	S.RES ERJ2GEJ 203 X (20K)	B	46.2/11.4
R1215	7030007350	S.RES ERJ2GEJ 393 X (39K)	B	45.3/11.4
R1216	7030005050	S.RES ERJ2GEJ 103 X (10K)	B	44.7/12.6
R1217	7030005050	S.RES ERJ2GEJ 103 X (10K)	B	44.7/13.5
R1218	7030005050	S.RES ERJ2GEJ 103 X (10K)	B	44.7/14.4
R1219	7030005040	S.RES ERJ2GEJ 472 X (4.7K)	B	74.4/41.1
R1220	7030009710	S.RES ERJ2GEJ 203 X (20K)	B	44.7/15.3
R1221	7030005040	S.RES ERJ2GEJ 472 X (4.7K)	B	82.9/41.6
R1222	7030005040	S.RES ERJ2GEJ 472 X (4.7K)	B	74.4/40.2
R1223	7030005040	S.RES ERJ2GEJ 472 X (4.7K)	B	74.4/39.3
R1224	7030005040	S.RES ERJ2GEJ 472 X (4.7K)	B	82.9/39.3
R1225	7030005240	S.RES ERJ2GEJ 473 X (47K)	B	83.1/35.7
R1226	7030005240	S.RES ERJ2GEJ 473 X (47K)	B	74.4/37.5
R1227	7030005240	S.RES ERJ2GEJ 473 X (47K)	B	73.8/38.4
R1228	7030005240	S.RES ERJ2GEJ 473 X (47K)	B	82.2/35.7
R1229	7030007350	S.RES ERJ2GEJ 393 X (39K)	B	43.5/15.4
R1230	7030004970	S.RES ERJ2GEJ 470 X (47)	B	49.2/2.2
R1231	7030005050	S.RES ERJ2GEJ 103 X (10K)	B	48.8/5.4
R1232	7030005220	S.RES ERJ2GEJ 223 X (22K)	B	40.3/3.2
R1235	7030007270	S.RES ERJ2GEJ 151 X (150)	T	66.2/5.9
R1236	7030007270	S.RES ERJ2GEJ 151 X (150)	T	66.2/7
R1237	7030007290	S.RES ERJ2GEJ 222 X (2.2K)	B	61.1/7.6
R1251	7030011250	S.RES ERJ1TY 390U (39)	T	70.3/6.4
R1301	7030005220	S.RES ERJ2GEJ 223 X (22K)	T	78.1/37.8
R1302	7030005050	S.RES ERJ2GEJ 103 X (10K)	T	78.1/36
R1303	7030005240	S.RES ERJ2GEJ 473 X (47K)	B	66/21.2
R1304	7030005240	S.RES ERJ2GEJ 473 X (47K)	B	66/20.3
R1305	7030009160	S.RES ERJ2GEJ 181 X (180)	T	68.5/25.9
R1306	7030005060	S.RES ERJ2GEJ 333 X (33K)	T	78.7/11.4
R1307	7030005040	S.RES ERJ2GEJ 472 X (4.7K)	T	68/21.9
R1308	7030005110	S.RES ERJ2GEJ 224 X (220K)	T	67.5/20
R1309	7030005110	S.RES ERJ2GEJ 224 X (220K)	T	69/19.4
R1310	7030005110	S.RES ERJ2GEJ 224 X (220K)	T	67.5/18.8
R1311	7030005110	S.RES ERJ2GEJ 224 X (220K)	T	69/18.2
R1312	7030005110	S.RES ERJ2GEJ 224 X (220K)	T	67.5/17.6
R1313	7030005110	S.RES ERJ2GEJ 224 X (220K)	T	69/17
R1314	7030005110	S.RES ERJ2GEJ 224 X (220K)	T	67.5/16.4
R1315	7030005110	S.RES ERJ2GEJ 224 X (220K)	T	69/15.8
R1316	7030005110	S.RES ERJ2GEJ 224 X (220K)	B	66.6/12.3
R1317	7030005110	S.RES ERJ2GEJ 224 X (220K)	B	65.7/12.3
R1318	7030005110	S.RES ERJ2GEJ 224 X (220K)	B	64.8/12.3
R1319	7030005110	S.RES ERJ2GEJ 224 X (220K)	B	63.9/12.3
R1320	7030005110	S.RES ERJ2GEJ 224 X (220K)	B	63/12.3
R1321	7030005110	S.RES ERJ2GEJ 224 X (220K)	B	62.1/12.3
R1322	7030005110	S.RES ERJ2GEJ 224 X (220K)	B	61.2/12.3
R1323	7030005110	S.RES ERJ2GEJ 224 X (220K)	B	60.3/12.1
R1324	7030005050	S.RES ERJ2GEJ 103 X (10K)	T	80.5/12.6
R1325	7030007350	S.RES ERJ2GEJ 393 X (39K)	T	78.1/9.8
R1326	7030005010	S.RES ERJ2GEJ 681 X (680)	B	78.9/2
R1327	7030005240	S.RES ERJ2GEJ 473 X (47K)	B	66/19.4
R1328	7030005050	S.RES ERJ2GEJ 103 X (10K)	B	75.9/6.4
R1329	7030005240	S.RES ERJ2GEJ 473 X (47K)	B	75.9/5.2
R1331	7030010040	S.RES ERJ2GEJ-JPW	B	75.9/3.2
R1332	7030005040	S.RES ERJ2GEJ 472 X (4.7K)	B	

[LOGIC UNIT]

REF NO.	PARTS NO.	DESCRIPTION	M.	H/V LOCATION
R1408	7030005240	S.RES ERJ2GEJ 473 X (47K)	B	76.7/25.3
R1409	7030005240	S.RES ERJ2GEJ 473 X (47K)	B	78.3/24.7
R1410	7030005240	S.RES ERJ2GEJ 473 X (47K)	B	78.3/23.5
R1411	7030005240	S.RES ERJ2GEJ 473 X (47K)	B	76.7/24.1
R1412	7030005240	S.RES ERJ2GEJ 473 X (47K)	B	43.6/24.7
R1413	7030005240	S.RES ERJ2GEJ 473 X (47K)	T	42.4/17.9
R1502	7030007300	S.RES ERJ2GEJ 332 X (3.3K)	B	80.9/28.4
R2101	7030005050	S.RES ERJ2GEJ 103 X (10K)	T	48.1/44.9
R2102	7030005050	S.RES ERJ2GEJ 103 X (10K)	T	47.7/42.7
R2103	7030005050	S.RES ERJ2GEJ 103 X (10K)	T	47.6/40.5
R2104	7030005050	S.RES ERJ2GEJ 103 X (10K)	T	47.7/43.7
R2105	7030005050	S.RES ERJ2GEJ 103 X (10K)	T	47.5/41.7
R2110	7030010040	S.RES ERJ2GEJ-JPW	B	21.4/22.5
R2112	7030005040	S.RES ERJ2GEJ 472 X (4.7K)	T	38.5/44.4
R2201	7030004980	S.RES ERJ2GEJ 101 X (100)	T	31.5/11.1
R2202	7030005050	S.RES ERJ2GEJ 103 X (10K)	T	30.6/11.1
R2203	7030005050	S.RES ERJ2GEJ 103 X (10K)	T	21.5/22.4
R2204	7030005050	S.RES ERJ2GEJ 103 X (10K)	T	35.2/15.5
R2205	7030005050	S.RES ERJ2GEJ 103 X (10K)	T	35.2/16.4
R2206	7030005050	S.RES ERJ2GEJ 103 X (10K)	T	21.5/21.5
R2214	7030005050	S.RES ERJ2GEJ 103 X (10K)	T	27.5/11.1
R2215	7030005050	S.RES ERJ2GEJ 103 X (10K)	T	28.4/11.1
R2216	7030010040	S.RES ERJ2GEJ-JPW	T	34.8/37.3
C1	4030016930	S.CER ECJ0EB1A104K	T	16.9/25.1
C2	4030016930	S.CER ECJ0EB1A104K	B	38.1/36
C3	4030016930	S.CER ECJ0EB1A104K	B	39.5/28.9
C4	4030016930	S.CER ECJ0EB1A104K	B	42.4/35.8
C5	4550007310	S.TAN F930J227MNMBSMA	T	40.8/23.4
C51	4030016930	S.CER ECJ0EB1A104K	B	19.2/27.4
C52	4030016930	S.CER ECJ0EB1A104K	B	19.2/28.3
C53	4550007310	S.TAN F930J227MNMBSMA	B	11.4/30.3
C54	4550007310	S.TAN F930J227MNMBSMA	T	7.1/8
C201	4030016930	S.CER ECJ0EB1A104K	B	19.4/0.2
C203	4030018960	S.CER C3216 JB 1C 106MT-N	T	18.8/45.5
C204	4030016930	S.CER ECJ0EB1A104K	T	11.9/40.2
C205	4030016930	S.CER ECJ0EB1A104K	T	11.9/41.8
C206	4030016930	S.CER ECJ0EB1A104K	B	8.8/43.4
C207	4030019460	S.CER C1608 JB 0J 106M-T	T	9.9/45
C302	4030016930	S.CER ECJ0EB1A104K	T	30.2/40.4
C303	4030016930	S.CER ECJ0EB1A104K	T	30.4/37.8
C304	4030016930	S.CER ECJ0EB1A104K	T	26.9/37.2
C305	4030016930	S.CER ECJ0EB1A104K	T	34.1/45.8
C306	4030016930	S.CER ECJ0EB1A104K	T	29.2/37.2
C307	4030016930	S.CER ECJ0EB1A104K	B	38.3/35
C308	4030016930	S.CER ECJ0EB1A104K	T	27.3/39.3
C309	4030016930	S.CER ECJ0EB1A104K	T	30.6/39.1
C310	4030016930	S.CER ECJ0EB1A104K	T	24.5/45.8
C311	4030016930	S.CER ECJ0EB1A104K	T	22/42.3
C312	4030016930	S.CER ECJ0EB1A104K	T	27.8/40.5
C313	4030016930	S.CER ECJ0EB1A104K	T	22/39.6
C314	4030016930	S.CER ECJ0EB1A104K	T	29.1/45.8
C315	4030016930	S.CER ECJ0EB1A104K	T	27.3/38.4
C316	4030016930	S.CER ECJ0EB1A104K	T	30.4/36.9
C317	4030016930	S.CER ECJ0EB1A104K	T	26.9/40.5
C318	4030016930	S.CER ECJ0EB1A104K	T	31.1/40.4
C319	4030016930	S.CER ECJ0EB1A104K	T	29.3/40.4
C320	4030016930	S.CER ECJ0EB1A104K	T	27.8/37.2
C413	4030018960	S.CER C3216 JB 1C 106MT-N	B	21.3/19.6
C414	4030016930	S.CER ECJ0EB1A104K	B	16.3/16.8
C415	4030018960	S.CER C3216 JB 1C 106MT-N	B	15.6/26.3
C461	4030016930	S.CER ECJ0EB1A104K	B	34.2/4.3
C462	4030018960	S.CER C3216 JB 1C 106MT-N	B	35.3/5.8
C463	4030018960	S.CER C3216 JB 1C 106MT-N	T	42/8.7
C464	4030016930	S.CER ECJ0EB1A104K	T	43.6/10.4
C465	4030017740	S.CER ECJ0EB1E821K	B	27.4/5.5
C466	4030017760	S.CER ECJ0EB1H222K	B	29.5/4.3
C467	4030017740	S.CER ECJ0EB1E821K	B	30.7/5.5
C468	4030018560	S.CER C2012 JB 1A 475K-T	T	31.8/2.6
C469	4030016930	S.CER ECJ0EB1A104K	B	24.8/8.7
C470	4030016930	S.CER ECJ0EB1A104K	B	33.8/8.3
C471	4030018560	S.CER C2012 JB 1A 475K-T	T	36.2/4.2
C472	4030018560	S.CER C2012 JB 1A 475K-T	T	36.2/2.5
C473	4030016930	S.CER ECJ0EB1A104K	T	40.2/4.2
C509	4030018960	S.CER C3216 JB 1C 106MT-N	T	24.2/5.5
C510	4030016930	S.CER ECJ0EB1A104K	T	26/4.4
C511	4030017760	S.CER ECJ0EB1H222K	T	30.7/8.9
C512	4030017690	S.CER ECJ0EC1H121J	T	32.1/7.7
C513	4030017690	S.CER ECJ0EC1H121J	T	29.4/7.7
C514	4030016930	S.CER ECJ0EB1A104K	T	36.4/6.5
C515	4030018860	S.CER ECJ0EB0J105K	T	36.5/9.2
C516	4030018860	S.CER ECJ0EB0J105K	T	36.5/8.3
C517	4030018860	S.CER ECJ0EB0J105K	T	36.5/10.1
C518	4030016930	S.CER ECJ0EB1A104K	T	26.1/6.8
C519	4030016930	S.CER ECJ0EB1A104K	T	41.3/11.9
C522	4030017780	S.CER ECJ0EB1E472K	B	38.9/9.8
C523	4030017780	S.CER ECJ0EB1E472K	B	38/2.8
C524	4030017780	S.CER ECJ0EB1E472K	T	3.8/2.6
C525	4030017780	S.CER ECJ0EB1E472K	T	22.4/2.7
C526	4030017780	S.CER ECJ0EB1E472K	T	42.9/3.8
C527	4030017780	S.CER ECJ0EB1E472K	B	24.1/2.8
C551	4030018520	S.CER C1608 JB 0J 225M-T	T	20/13.8
C553	4030016930	S.CER ECJ0EB1A104K	T	19/13.9
C563	4030018960	S.CER C3216 JB 1C 106MT-N	B	18.9/6.6
C564	4030016930	S.CER ECJ0EB1A104K	T	18.1/13.9
C565	4030016930	S.CER ECJ0EB1A104K	T	17.8/3.2

[LOGIC UNIT]

REF NO.	PARTS NO.	DESCRIPTION	M.	H/V LOCATION
C566	4030016930	S.CER ECJ0EB1A104K	T	19.4/3.2
C567	4030018960	S.CER C3216 JB 1C 106MT-N	B	21.3/12.3
C569	4030018960	S.CER C3216 JB 1C 106MT-N	B	19.2/12.3
C601	4030018960	S.CER C3216 JB 1C 106MT-N	B	3.7/12
C602	4030016930	S.CER ECJ0EB1A104K	T	3.9/10.9
C603	4030018820	S.CER ECJ0EB1H561K	B	13.4/6
C604	4510008640	S.ELE 6 CE 100 FE	B	4.8/6.7
C605	4030016930	S.CER ECJ0EB1A104K	T	10/8.4
C606	4030018580	S.CER C1608 CH 1H 821J-T	B	9.6/5.6
C607	4030017440	S.CER ECJ0EC1H221J	B	13.3/8.4
C608	4030017440	S.CER ECJ0EC1H221J	B	14.8/8.8
C609	4030018860	S.CER ECJ0EB0J105K	B	15.8/14.5
C610	4030010760	S.CER C1608 CH 1H 331J-T	B	9.6/8.3
C611	4030010760	S.CER C1608 CH 1H 331J-T	B	11.8/7.7
C612	4030018960	S.CER C3216 JB 1C 106MT-N	B	7.5/13.1
C613	4550006780	S.TAN TEESVB2 0J 476M8R	B	20.6/2.7
C614	4550006780	S.TAN TEESVB2 0J 476M8R	T	3.1/6.6
C651	4030017460	S.CER ECJ0EB1E102K	B	65.5/31.4
C652	4030017460	S.CER ECJ0EB1E102K	B	66/16.4
C653	4030017460	S.CER ECJ0EB1E102K	B	77.1/20.9
C654	4030017430	S.CER ECJ0EC1H101J	B	77.2/28.2
C655	4030017430	S.CER ECJ0EC1H101J	B	76.5/27.1
C656	4030017430	S.CER ECJ0EC1H101J	B	76.1/26.2
C701	4030016930	S.CER ECJ0EB1A104K	B	3/13.5
C702	4030017780	S.CER ECJ0EB1E472K	B	4.4/18.8
C703	4030017780	S.CER ECJ0EB1E472K	B	7.5/26.1
C704	4030017780	S.CER ECJ0EB1E472K	B	19.7/26.2
C705	4030017430	S.CER ECJ0EC1H101J	B	4.6/21.9
C706	4030017430	S.CER ECJ0EC1H101J	B	4.6/24.6
C707	4030017430	S.CER ECJ0EC1H101J	B	3.9/27.1
C708	4030017430	S.CER ECJ0EC1H101J	B	6.6/26.1
C709	4030017430	S.CER ECJ0EC1H101J	T	2.5/20.1
C711	4550007310	S.TAN F930J227MNMBSMA	T	5.5/18.9
C715	4030017460	S.CER ECJ0EB1E102K	T	2.2/17.6
C716	4030017460	S.CER ECJ0EB1E102K	T	2.2/18.6
C717	4030017460	S.CER ECJ0EB1E102K	T	2.2/16.6
C1001	4030017780	S.CER ECJ0EB1E472K	B	76.7/18.9
C1002	4030017780	S.CER ECJ0EB1E472K	B	70.4/38.2
C1101	4030017780	S.CER ECJ0EB1E472K	T	79.9/23.7
C1102	4030017780	S.CER ECJ0EB1E472K	T	73.6/20.7
C1103	4030016930	S.CER ECJ0EB1A104K	T	81.8/14.5
C1106	4030017780	S.CER ECJ0EB1E472K	T	79.7/31.9
C1107	4030018900	S.CER ECJ0EB0J474K	B	80.1/25.5
C1108	4030018900	S.CER ECJ0EB0J474K	B	81.4/25.4
C1109	4030017780	S.CER ECJ0EB1E472K	T	79.7/26.3
C1110	4030017780	S.CER ECJ0EB1E472K	T	80.7/26.3
C1111	4030017780	S.CER ECJ0EB1E472K	T	81.7/26.3
C1112	4030017780	S.CER ECJ0EB1E472K	B	82.9/28.4
C1201	4030016930	S.CER ECJ0EB1A104K	B	50.6/4.3
C1202	4030017780	S.CER ECJ0EB1E472K	B	53.2/4.3
C1203	4030017650	S.CER ECJ0EC1H270J	B	62.7/6.7
C1204	4030016930	S.CER ECJ0EB1A104K	B	47.9/8
C1205	4030016930	S.CER ECJ0EB1A104K	B	45.2/9.6
C1206	4030016930	S.CER ECJ0EB1A104K	B	43.5/13.8
C1207	4030017430	S.CER ECJ0EC1H101J	B	47/9.6
C1208	4030017430	S.CER ECJ0EC1H101J	B	43.9/8.7
C1209	4030017430	S.CER ECJ0EC1H101J	B	44.4/11.4
C1210	4030017650	S.CER ECJ0EC1H270J	B	61.1/6.7
C1211	4030018860	S.CER ECJ0EB0J105K	B	60.2/10.5
C1212	4030016930	S.CER ECJ0EB1A104K	B	49.7/4.3
C1213	4030016930	S.CER ECJ0EB1A104K	B	49.2/6.6
C1214	4030016930	S.CER ECJ0EB1A104K	B	40.3/4.8
C1215	4030016930	S.CER ECJ0EB1A104K	B	64.2/19.3
C1216	4030016930	S.CER ECJ0EB1A104K	B	53.7/30.3
C1217	4030016930	S.CER ECJ0EB1A104K	B	57.5/29.2
C1218	4030016930	S.CER ECJ0EB1A104K	B	44.8/23.9
C1219	4030016930	S.CER ECJ0EB1A104K	B	46.3/13.2
C1220	4030016930	S.CER ECJ0EB1A104K	B	56/8.8
C1221	4030016930	S.CER ECJ0EB1A104K	B	60.5/13.7
C1222	4030016930	S.CER ECJ0EB1A104K	B	60.9/25.6
C1223	4030016930	S.CER ECJ0EB1A104K	T	52.7/12.3
C1225	4030018960	S.CER C3216 JB 1C 106MT-N	T	66.7/10.2
C1251	4030012610	S.CER C2012 JB 1C 474K-T	T	73.4/9.3
C1252	4550007320	S.TAN F930J226MAABMA	T	73.4/4.4
C1301	4030016930	S.CER ECJ0EB1A104K	T	80.1/40.3
C1302	4030018960	S.CER C3216 JB 1C 106MT-N	T	47.9/11.4
C1303	4030016790	S.CER ECJ0EB1C103K	T	67.9/30.4
C1304	4030016930	S.CER ECJ0EB1A104K	T	41.7/31.5
C1305	4030018960	S.CER C3216 JB 1C 106MT-N	T	44.3/37.2
C1306	4030016790	S.CER ECJ0EB1C103K	T	64/37.5
C1307	4030016930	S.CER ECJ0EB1A104K	T	48.4/12.9
C1308	4030016930	S.CER ECJ0EB1A104K	T	63.1/13.1
C1309	4030016930	S.CER ECJ0EB1A104K	T	46.1/37.2
C1310	4030016930	S.CER ECJ0EB1A104K	T	67/30.9
C1311	4030016930	S.CER ECJ0EB1A104K	T	67/25.7
C1312	4030017620	S.CER ECJ0EC1H100C	T	67.4/29.1
C1313	4030017620	S.CER ECJ0EC1H100C	T	67.4/28.2
C1314	4030016930	S.CER ECJ0EB1A104K	T	79/9.8
C1315	4030017030	S.CER ECJ0EB1A273K	T	83.3/10.8
C1316	4030016930	S.CER ECJ0EB1A104K	B	75.9/2.3
C1317	4030018960	S.CER C3216 JB 1C 106MT-N	B	84.4/3
C1319	4030018960	S.CER C3216 JB 1C 106		

[LOGIC UNIT]

REF NO.	PARTS NO.	DESCRIPTION	M.	H/V LOCATION
C2204	4030016930	S.CER ECJ0EB1A104K	T	26.5/19.2
C2205	4030016930	S.CER ECJ0EB1A104K	T	30.2/19.7
C2206	4030016930	S.CER ECJ0EB1A104K	T	26.6/11.1
C2207	4030016930	S.CER ECJ0EB1A104K	T	27.7/19.7
C2208	4030016930	S.CER ECJ0EB1A104K	T	21.5/23.4
C2209	4030016930	S.CER ECJ0EB1A104K	T	29.8/17.6
C2210	4030016930	S.CER ECJ0EB1A104K	T	26.6/17.8
C2211	4030016930	S.CER ECJ0EB1A104K	T	32.4/11.1
C2212	4030016930	S.CER ECJ0EB1A104K	T	35.2/14.6
C2213	4030016930	S.CER ECJ0EB1A104K	T	29.3/16.4
C2214	4030016930	S.CER ECJ0EB1A104K	T	35.2/17.3
C2215	4030016930	S.CER ECJ0EB1A104K	T	29.3/11.1
C2217	4030016930	S.CER ECJ0EB1A104K	T	29.8/18.5
C2218	4030016930	S.CER ECJ0EB1A104K	T	26.5/20.1
C2219	4030016930	S.CER ECJ0EB1A104K	T	30.2/16.4
C2220	4030016930	S.CER ECJ0EB1A104K	T	26.1/16.5
C2221	4030016930	S.CER ECJ0EB1A104K	T	27.9/16.5
C2222	4030016930	S.CER ECJ0EB1A104K	T	29.3/19.7
J651	6510024811	S.CON AXK6S60637YG	B	71/24.9
J701	6510022071	S.CON AXK6S30637YG	B	10.9/20.4
J1201	6510018891	S.CON 52559-1370(1390)	B	77.5/38.2
J2101	6510020130	S.CON AXN810535P	T	52.4/42.9
BT1301	3020000330	LIT ML920S/F9D		
EP2	6910012350	S.BEA MMZ1608Y 102BT	T	18.8/38.2
EP51	6910012350	S.BEA MMZ1608Y 102BT	B	18.1/29.7
EP201	6910014730	S.BEA MPZ2012S331A-T	T	13.3/40.6
EP301	6910012350	S.BEA MMZ1608Y 102BT	T	19.1/40
EP701	6910012350	S.BEA MMZ1608Y 102BT	B	5.6/15.3
EP2002	6910012350	S.BEA MMZ1608Y 102BT	B	38.2/27.6
EP2202	6910012350	S.BEA MMZ1608Y 102BT	T	19.1/22
EP2205	6910014730	S.BEA MPZ2012S331A-T	T	18.4/17.7
EP2217	6910015970	S.BEA MMZ1608B 301CT-AS	B	20.9/16.1

[CONNECT UNIT]

REF NO.	PARTS NO.	DESCRIPTION	M.	H/V LOCATION
J1	6510019971	S.CON 52808-1071	T	7.1/11.8
W1	8900016410	CAB OPC-1579A		

[DDS UNIT]

REF NO.	PARTS NO.	DESCRIPTION	M.	H/V LOCATION
IC51	1190001811	S.IC AD9833BRMZ-REEL7	T	38.7/3.5
IC52	1130012781	S.IC SN74AHC2G04HDCT3	T	45/5.6
IC61	1130012610	S.IC SN74AHC1GU04DCKR	T	37.5/7.5
IC62	1130012850	S.IC SN74LVC3G34DCUR	T	51.3/24.7
IC251	1180002321	S.REG TK11218CMCL-G	B	29.5/16.2
IC301	1190002101	S.IC AD9951YSVZ	T	37.5/28.2
IC401	1110004080	S.IC UPC2709T-E3	T	50.1/47
IC451	1110006430	S.IC UPC1678GV-E1-A	T	34.1/50.2
IC801	1110006430	S.IC UPC1678GV-E1-A	T	18/13.7
IC901	1130012720	S.IC CD74HC4094PWR	T	5.4/64.7
Q1	1530002381	S.TRA 2SC4215-Y(TE85L,F)	T	20.4/3.1
Q101	1530002561	S.TRA 2SC4403-3-TL-E	T	26.5/6.4
Q151	1530003151	S.TRA 2SC4673D-TD-E	T	41.4/13.7
Q201	1530003432	S.TRA 2SC5226A-4-TL-E	T	43.4/19.4
Q211	1530003432	S.TRA 2SC5226A-4-TL-E	B	43.5/15.2
Q301	1590000680	S.TRA DTC114EUA T106	B	45.3/32.3
Q901	1590003930	S.TRA UMD22N TR	T	4/58.7
Q902	1590003930	S.TRA UMD22N TR	T	4.1/55.1
Q903	1590003930	S.TRA UMD22N TR	T	7.2/55.1
Q904	1590003930	S.TRA UMD22N TR	T	7.2/58.7
Q905	1590003930	S.TRA UMD22N TR	T	4.1/70.7
Q906	1590003930	S.TRA UMD22N TR	T	4.1/74.2
Q907	1590003930	S.TRA UMD22N TR	T	7.1/70.7
Q908	1590003930	S.TRA UMD22N TR	T	7.1/74.2
Q1101	1530002060	S.TRA 2SC4081 T106 R	T	40.9/53.9
Q1102	1540000451	S.TRA 2SD1623T-TD-E	T	45.5/54.3
D301	1750000620	S.DIO MA717WK(TX)	B	44.8/35.9
D341	1790001621	S.DIO 1SV308(TPL3,F)	B	45.2/39.7
D451	1750000581	S.DIO 1SV307(TPH3,F)	T	44.2/47.7
D452	1750000581	S.DIO 1SV307(TPH3,F)	T	44/44.8
D453	1790001621	S.DIO 1SV308(TPL3,F)	T	43.3/36.6
D454	1750000581	S.DIO 1SV307(TPH3,F)	T	38.3/48.3
D456	1750000620	S.DIO MA717WK(TX)	B	35.1/42.8
D458	1750000581	S.DIO 1SV307(TPH3,F)	T	33.8/45.6
D459	1750000581	S.DIO 1SV307(TPH3,F)	T	31.3/38.8
D471	1750000620	S.DIO MA717WK(TX)	T	33.2/36.6
D501	1750000581	S.DIO 1SV307(TPH3,F)	B	26.2/42.6
D502	1750000581	S.DIO 1SV307(TPH3,F)	T	3/50.6
D551	1750000581	S.DIO 1SV307(TPH3,F)	T	25.9/45.1
D552	1750000581	S.DIO 1SV307(TPH3,F)	T	2.9/45.3
D601	1750000581	S.DIO 1SV307(TPH3,F)	T	27.2/39.9
D602	1750000581	S.DIO 1SV307(TPH3,F)	T	2.9/40.1
D651	1750000581	S.DIO 1SV307(TPH3,F)	T	27.2/34.8
D652	1750000581	S.DIO 1SV307(TPH3,F)	T	2.9/34.9
D701	1750000581	S.DIO 1SV307(TPH3,F)	T	27.2/29.5
D702	1750000581	S.DIO 1SV307(TPH3,F)	T	2.9/29.7
D751	1750000581	S.DIO 1SV307(TPH3,F)	T	27/24.4
D752	1750000581	S.DIO 1SV307(TPH3,F)	T	2.9/24.6
D801	1750000581	S.DIO 1SV307(TPH3,F)	T	28.3/21.6
D802	1750000581	S.DIO 1SV307(TPH3,F)	T	2.9/19.3
D1101	1750000301	S.DIO 1SS302(E85R,F)	T	40.9/57.7
D1102	1160000080	S.DIO DAP202K T146	B	27.9/63
FI101	2010002660	S.XTA DSF334SAF 124.032 MHz (FL-391)	T	29.3/10.7
FI201	2040001860	S.SAW NSVS776	T	34.5/16.5
X1	6050012800	S.XTA CR-788B VC-TCXO 24.8064 MHz	T	13.8/3.7
L1	6200002641	S.COI NLV25T-R15J	T	26/3.7
L51	6200005011	S.COI NLV25T-100J	B	35.6/4.2
L52	6200005011	S.COI NLV25T-100J	B	38.8/3.8
L53	6200003241	S.COI NLV32T-221J	B	43.4/8.7
L54	6200009351	S.COI ELJRE R22GFA	T	34.6/8.6
L101	6200003540	S.COI MLF1608D R22K-T	T	24.2/8.8
L105	6200012650	S.COI MLF1608A 1R5J-T	T	23.7/5.2
L151	6200004470	S.COI MLF1608D R12K-T	T	44.7/12.8
L153	6200004150	S.COI MLF1608D 47NM-T	T	46.9/15.7
L201	6200004150	S.COI MLF1608D 47NM-T	T	44.5/21.5
L202	6200005661	S.COI ELJRE 10NGFA	B	37.5/12.4
L204	6200003540	S.COI MLF1608D R22K-T	T	41.5/19.3
L205	6200005711	S.COI ELJRE 27NGFA	B	47.1/21.7
L206	6200005701	S.COI ELJRE 22NGFA	B	46.2/20.4
L210	6200005701	S.COI ELJRE 22NGFA	B	47/19.1
L212	6200002581	S.COI NLV25T-033J	B	41.9/12.8
L213	6200005681	S.COI ELJRE 15NGFA	B	40.1/17.8
L301	6140002810	S.COI LR-317	T	48.5/30
L302	6140002810	S.COI LR-317	T	48.7/38.9
L303	6200004150	S.COI MLF1608D 47NM-T	B	41.9/35.7
L304	6200003960	S.COI MLF1608A 1R0K-T	T	50.4/33.2
	6200003960	S.COI MLF1608A 1R0K-T	[EUR]	
	6200003960	S.COI MLF1608A 1R0K-T	[FRA]	
	6200003960	S.COI MLF1608A 1R0K-T	[ESP]	
	6200003960	S.COI MLF1608A 1R0K-T	[USA]	
	6200003960	S.COI MLF1608A 1R0K-T	[EXP]	
	6200003960	S.COI MLF1608A 1R0K-T	[ITR]	
	6200003960	S.COI MLF1608A 1R0K-T	[UK]	
	6200003960	S.COI MLF1608A 1R0K-T	[KOR]	
	6200003960	S.COI MLF1608A 1R0K-T	[CHN]	
L321	6200009560	S.COI MLG1608B R10J-T	T	50.4/34.7
L322	6200011770	S.COI LQW18ANR10G00D	T	47.8/34.7

M.=Mounted side (T: Mounted on the Top side, B: Mounted on the Bottom side)
S.=Surface mount

[DDS UNIT]

REF NO.	PARTS NO.	DESCRIPTION	M.	H/V LOCATION
L323	6200005671	S.COI ELJRE 12NGFA	T	53.6/30.1
L331	6200009680	S.COI MLG1608B 47NJ-T	T	47.6/43.1
L332	6200009680	S.COI MLG1608B 47NJ-T	T	50.2/43.1
L341	6200004470	S.COI MLF1608D R12K-T	B	41.1/37
L401	6200001981	S.COI NLV25T-1R0J	T	50.2/49.9
L411	6200009610	S.COI MLG1608B 39NJ-T	T	47.3/48.3
L456	6140002810	S.COI LR-317	T	40.1/44.9
L458	6200009680	S.COI MLG1608B 47NJ-T	B	37.5/42.1
L461	6200009660	S.COI MLG1608B 10NJ-T	B	39.3/41.7
L464	6200002631	S.COI NLV25T-R10J	T	28.8/50.6
L465	6200004470	S.COI MLF1608D R12K-T	T	42.9/39.5
L466	6200011580	S.COI LQW18AN33NG00D	T	39.1/41.1
L467	6200009670	S.COI MLG1608B 12NJ-T	T	27.7/47.1
L468	6200009590	S.COI MLG1608B 18NJ-T	T	26.1/48.3
L469	6200009580	S.COI MLG1608B 15NJ-T	T	33.6/41.3
L471	6140002810	S.COI LR-317	T	38.7/37.2
L472	6200009680	S.COI MLG1608B 47NJ-T	T	33.4/39.3
L473	6200009540	S.COI MLG1608B 22NJ-T	T	35.5/40.4
L501	6200002611	S.COI NLV25T-R47J	B	21.7/43.6
L502	6200002631	S.COI NLV25T-R10J	B	18.1/46.7
L503	6200002431	S.COI NLV25T-082J	B	15/46.4
L504	6200002411	S.COI NLV25T-056J	T	14.3/49.4
L505	6200002421	S.COI NLV25T-068J	T	11.2/50.2
L506	6200002421	S.COI NLV25T-068J	T	8.2/49.7
L507	6200002611	S.COI NLV25T-R47J	T	3.8/48.2
L551	6200002611	S.COI NLV25T-R47J	T	24.9/42.6
L552	6200002421	S.COI NLV25T-068J	T	20.3/43
L553	6200002411	S.COI NLV25T-056J	T	17.6/42.9
L554	6200002601	S.COI NLV25T-047J	T	14.7/45
L555	6200002601	S.COI NLV25T-047J	T	12.4/44.3
L556	6200002581	S.COI NLV25T-033J	T	9.2/45
L557	6200002611	S.COI NLV25T-R47J	T	4.5/42.8
L601	6200002611	S.COI NLV25T-R47J	T	25.3/37.4
L602	6200002601	S.COI NLV25T-047J	T	22.6/39.6
L603	6200002591	S.COI NLV25T-039J	T	19.7/39.1
L604	6200003891	S.COI NLV25T-027J	T	16.8/39.9
L605	6200002601	S.COI NLV25T-047J	T	14.1/37.9
L606	6200002601	S.COI NLV25T-047J	T	11.4/37.7
L607	6200002421	S.COI NLV25T-068J	T	8.6/37.7
L608	6200002601	S.COI NLV25T-047J	T	5.1/37.7
L651	6200002611	S.COI NLV25T-R47J	T	26/32.2
L652	6200002591	S.COI NLV25T-039J	T	22.4/32.5
L653	6200002591	S.COI NLV25T-039J	T	19.6/32.8
L654	6200002591	S.COI NLV25T-039J	T	14/34.6
L655	6200002591	S.COI NLV25T-039J	T	11.2/33.9
L656	6200002601	S.COI NLV25T-047J	T	16.7/32.5
L657	6200002581	S.COI NLV25T-033J	T	7.9/34.6
L658	6200002611	S.COI NLV25T-R47J	T	5.2/32.6
L701	6200002611	S.COI NLV25T-R47J	T	26/26.9
L702	6200002581	S.COI NLV25T-033J	T	22.9/29.2
L703	6200002581	S.COI NLV25T-033J	T	20.2/28.7
L704	6200003891	S.COI NLV25T-027J	T	17.3/29.5
L705	6200002591	S.COI NLV25T-039J	T	14.6/27.3
L706	6200002581	S.COI NLV25T-033J	T	11.8/27.3
L707	6200002581	S.COI NLV25T-033J	T	9.1/27.2
L708	6200002611	S.COI NLV25T-R47J	T	4.5/27.2
L751	6200002611	S.COI NLV25T-R47J	T	25.9/22
L752	6200003881	S.COI NLV25T-022J	T	22.4/22.4
L753	6200003891	S.COI NLV25T-027J	T	19.7/22.2
L754	6200002581	S.COI NLV25T-033J	T	16.9/22.5
L755	6200003891	S.COI NLV25T-027J	T	14.2/24.2
L756	6200003891	S.COI NLV25T-027J	T	11.4/23.5
L757	6200003881	S.COI NLV25T-022J	T	8.7/24.2
L758	6200002611	S.COI NLV25T-R47J	T	3.9/22.2
L801	6200002181	S.COI NLV25T-R12J	T	28.3/17.5
L803	6200005711	S.COI ELJRE 27NGFA	T	26.3/17.6
L804	6200009070	S.COI LQW18AN18NG00D (LQW1608A18NG00)	T	25/15.6
L805	6200009220	S.COI LQW18AN15NG00D (LQW1608A15NG00)	T	23.1/14.9
L806	6200005641	S.COI ELJRE 6N8ZFA	T	21.5/19
L807	6200009670	S.COI MLG1608B 12NJ-T	T	18.7/18.2
L808	6200004720	S.COI MLF1608D R10K-T	T	17.9/10
L812	6200005711	S.COI ELJRE 27NGFA	T	14.8/14.4
L813	6200009070	S.COI LQW18AN18NG00D (LQW1608A18NG00)	T	15.7/17.2
L814	6200009220	S.COI LQW18AN15NG00D (LQW1608A15NG00)	T	13.8/18.2
L815	6200005641	S.COI ELJRE 6N8ZFA	T	10.1/18
L816	6200010700	S.COI LQW18AN12NG00D	T	6.6/17.8
L818	6200002181	S.COI NLV25T-R12J	T	4.6/17
L851	6200002181	S.COI NLV25T-R12J	B	26.8/30.6
L852	6200002611	S.COI NLV25T-R47J	B	26.4/34.1
L853	6200002181	S.COI NLV25T-R12J	B	3.4/22.8
L854	6200002611	S.COI NLV25T-R47J	B	5.4/26
L901	6200007420	S.COI ELJFC 101K-F	B	3.7/65.9
L953	6200002041	S.COI NLV25T-101J	B	56.4/44.6
L954	6200002041	S.COI NLV25T-101J	B	55.7/42.1
L955	6200002041	S.COI NLV25T-101J	B	55.9/39.6
L956	6200002041	S.COI NLV25T-101J	B	56.1/37.1
L957	6200002041	S.COI NLV25T-101J	B	55.9/34.6
L959	6200011300	S.COI EXCML16A270U	T	54.9/34.3
L960	6200002041	S.COI NLV25T-101J	B	56.6/30.3
L962	6200011300	S.COI EXCML16A270U	B	59.2/32.2
L963	6200011300	S.COI EXCML16A270U	B	60.4/32.2
L1001	6200003241	S.COI NLV32T-221J	B	53.7/50.8
L1002	6200003241	S.COI NLV32T-221J	B	47.9/55

[DDS UNIT]

REF NO.	PARTS NO.	DESCRIPTION	M.	H/V LOCATION
L1103	6200002041	S.COI NLV25T-101J	B	42.2/61.2
L1105	6200002041	S.COI NLV25T-101J	B	40.8/71.8
L1106	6200002041	S.COI NLV25T-101J	T	36.4/62.3
L1107	6200002041	S.COI NLV25T-101J	T	34.9/74.7
L1110	6200002041	S.COI NLV25T-101J	T	32.4/62.3
L1111	6200002041	S.COI NLV25T-101J	B	26.1/69.8
L1112	6200002041	S.COI NLV25T-101J	T	29.9/62.3
L1152	6200003590	S.COI EXCCL3225U1	T	48.3/69.2
L1153	6200002041	S.COI NLV25T-101J	T	45.5/69.3
L1154	6200002041	S.COI NLV25T-101J	T	53.6/69.2
R2	7030007290	S.RES ERJ2GEJ 222 X (2.2K)	T	19.1/4.5
R3	7030005040	S.RES ERJ2GEJ 472 X (4.7K)	T	18.6/1.8
R4	7030004990	S.RES ERJ2GEJ 221 X (220)	T	22.2/2.6
R5	7030004980	S.RES ERJ2GEJ 101 X (100)	T	20.9/6.9
R8	7030003630	S.RES ERJ3GEYJ 393 V (39K)	B	13.6/7.1
R9	7030003610	S.RES ERJ3GEYJ 273 V (27K)	B	13.6/9.7
R10	7030005060	S.RES ERJ2GEJ 333 X (33K)	T	8/3.2
R11	7030010040	S.RES ERJ2GEJ-JPW	T	9.2/3.7
R51	7030005120	S.RES ERJ2GEJ 102 X (1K)	T	35.7/9.5
R52	7030005120	S.RES ERJ2GEJ 102 X (1K)	T	46.1/2.3
R53	7030005120	S.RES ERJ2GEJ 102 X (1K)	T	42.8/3.5
R54	7030005120	S.RES ERJ2GEJ 102 X (1K)	T	42.8/2.6
R61	7030005050	S.RES ERJ2GEJ 103 X (10K)	T	39.3/8.1
R62	7030005530	S.RES ERJ2GEJ 100 X (10)	T	49.3/23.1
R101	7030005000	S.RES ERJ2GEJ 471 X (470)	T	25.2/7.8
R102	7030004980	S.RES ERJ2GEJ 101 X (100)	T	22.1/7.4
R103	7030005570	S.RES ERJ2GEJ 820 X (82)	T	31.8/11.1
R104	7030004980	S.RES ERJ2GEJ 101 X (100)	T	33/11.5
R105	7030005570	S.RES ERJ2GEJ 820 X (82)	T	34.2/11.2
R106	7030005100	S.RES ERJ2GEJ 154 X (150K)	T	23.9/7.4
R121	7030005040	S.RES ERJ2GEJ 472 X (4.7K)	T	38.5/11.1
R150	7030005570	S.RES ERJ2GEJ 820 X (82)	T	45.8/10.7
R151	7030004980	S.RES ERJ2GEJ 101 X (100)	T	44.9/10.7
R154	7030005050	S.RES ERJ2GEJ 103 X (10K)	T	41.4/10.6
R155	7030005530	S.RES ERJ2GEJ 100 X (10)	T	46.3/12.6
R157	7030007270	S.RES ERJ2GEJ 151 X (150)	T	48.8/17.2
R158	7030009200	S.RES ERJ2GEJ 390 X (39)	T	48/16.7
R159	7030007270	S.RES ERJ2GEJ 151 X (150)	T	47.9/18.2
R160	7030005300	S.RES ERJ2GEJ 150 X (15)	T	44.2/15.9
R161	7030004980	S.RES ERJ2GEJ 101 X (100)	T	45.1/15.9
R162	7030005300	S.RES ERJ2GEJ 150 X (15)	T	45/14.6
R201	7030005530	S.RES ERJ2GEJ 100 X (10)	T	45.8/22
R202	7030000700	S.RES MCR10EZHJ 470 K (474)	T	45.6/18.8
R211	7030003400	S.RES ERJ3GEYJ 471 V (470)	B	37.3/17.8
R212	7030003440	S.RES ERJ3GEYJ 102 V (1K)	B	40.8/16.2
R213	7030003200	S.RES ERJ3GEYJ 100 V (10)	B	44.5/11.4
R214	7030003280	S.RES ERJ3GEYJ 470 V (47)	B	46.8/16.3
R301	7030005120	S.RES ERJ2GEJ 102 X (1K)	T	34.2/22.2
R303	7030010040	S.RES ERJ2GEJ-JPW	T	40/22.2
R304	7030005120	S.RES ERJ2GEJ 102 X (1K)	T	42/24.6
R305	7030005710	S.RES ERJ2GEJ 121 X (120)	T	44.1/28.9
R306	7030005120	S.RES ERJ2GEJ 102 X (1K)	T	31.5/25.6
R309	7030005120	S.RES ERJ2GEJ 102 X (1K)	T	31.2/29.4
R310	7030005120	S.RES ERJ2GEJ 102 X (1K)	T	31.2/30.5
R311	7030005120	S.RES ERJ2GEJ 102 X (1K)	T	31.2/31.5
R312	7030010040	S.RES ERJ2GEJ-JPW	T	32.9/31.7
R313	7030005710	S.RES ERJ2GEJ 121 X (120)	T	43.2/28.5
R314	7030009140	S.RES ERJ2GEJ 272 X (2.7K)	T	43/31.8
R315	7030005120	S.RES ERJ2GEJ 102 X (1K)	T	33.5/32.6
R316	7030005050	S.RES ERJ2GEJ 103 X (10K)	T	34.6/33.8
R317	7030004990	S.RES ERJ2GEJ 221 X (220)	T	43.9/31.8
R318	7030003860	S.RES ERJ3GE JPW V [EUR]	B	35.8/28.4
	7030003860	S.RES ERJ3GE JPW V [FRA]		
	7030003860	S.RES ERJ3GE JPW V [ESP]		
	7030003860	S.RES ERJ3GE JPW V [USA]		
	7030003860	S.RES ERJ3GE JPW V [EXP]		
	7030003860	S.RES ERJ3GE JPW V [ITR]		
	7030003860	S.RES ERJ3GE JPW V [KOR]		
	7030003860	S.RES ERJ3GE JPW V [AUS]		
	7030003860	S.RES ERJ3GE JPW V [CHN]		
R341	7030003440	S.RES ERJ3GEYJ 102 V (1K)	B	44.3/38.3
R342	7030003440	S.RES ERJ3GEYJ 102 V (1K)	B	45.9/41.2
R451	7030005120	S.RES ERJ2GEJ 102 X (1K)	T	44.5/46.2
R452	7030003860	S.RES ERJ3GE JPW V	B	48.6/44.6
R453	7030010090	S.RES ERJ2GEJ 180 X (18)	T	34.1/47.4
R454	7030008280	S.RES ERJ2GEJ 271 X (270)	T	32.9/47
R455	7030008280	S.RES ERJ2GEJ 271 X (270)	T	32.9/47.9
R456	7030010040	S.RES ERJ2GEJ-JPW	T	34.9/52.4
R457	7030005120	S.RES ERJ2GEJ 102 X (1K)	T	38.1/49.7
R458	7030004990	S.RES ERJ2GEJ 221 X (220)	T	31.6/43.6
R459	7030005090	S.RES ERJ2GEJ 104 X (100K)	T	42.1/50
R460	7030003680	S.RES ERJ3GEYJ 104 V (100K)	T	30.7/41
R461	7030005090	S.RES ERJ2GEJ 104 X (100K)	T	29.6/39.1
R462	7030003860	S.RES ERJ3GE JPW V	T	45/43.3
R463	7030003400	S.RES ERJ3GEYJ 471 V (470)	T	33.3/44
R464	7030004980	S.RES ERJ2GEJ 101 X (100)	T	40.8/47.9
R465	7030005570	S.RES ERJ2GEJ 820 X (82)	T	40.3/50
R467	7030005570	S.RES ERJ2GEJ 820 X (82)	T	40.8/48.8
R468	7030005570	S.RES ERJ2GEJ 820 X (82)	T	41.2/50
R469	7030003320	S.RES ERJ3GEYJ 101 V (100)	B	37.7/39.9
R471	7030005000	S.RES ERJ2GEJ 471 X (470)	T	41.6/37.7
R472	7030004990	S.RES ERJ2GEJ 221 X (220)	T	30.3/43.3
R473	7030007270	S.RES ERJ2GEJ 151 X (150)	T	31.7/34.5
R474	7030009200	S.RES ERJ2GEJ 390 X (39)	T	31.3/35.7
R475	7030007270	S.RES ERJ2GEJ 151 X (150)	T	30.1/35.3

M.=Mounted side (T: Mounted on

[DDS UNIT]

REF NO.	PARTS NO.	DESCRIPTION	M.	H/V LOCATION
R476	7030005000	S.RES ERJ2GEJ 471 X (470)	T	29.9/37.9
R477	7030003320	S.RES ERJ3GEYJ 101 V (100)	B	35.7/38.6
R501	7030003390	S.RES ERJ3GEYJ 391 V (390)	B	21/46.1
R502	7030009280	S.RES ERJ2GEJ 391 X	T	5.8/46.8
R503	7030005090	S.RES ERJ2GEJ 104 X (100K)	T	14.3/46.8
R505	7030005570	S.RES ERJ2GEJ 820 X (82)	T	6.5/48.6
R506	7030005570	S.RES ERJ2GEJ 820 X (82)	T	6/49.8
R507	7030005570	S.RES ERJ2GEJ 820 X (82)	T	5.6/48.6
R551	7030009280	S.RES ERJ2GEJ 391 X	T	23.1/42
R552	7030009280	S.RES ERJ2GEJ 391 X	T	6.3/42
R553	7030005090	S.RES ERJ2GEJ 104 X (100K)	T	10.1/41.6
R554	7030009200	S.RES ERJ2GEJ 390 X (39)	T	6.4/45.7
R555	7030007270	S.RES ERJ2GEJ 151 X (150)	T	7.1/44.4
R556	7030007270	S.RES ERJ2GEJ 151 X (150)	T	6.2/44.3
R601	7030008280	S.RES ERJ2GEJ 271 X (270)	T	23.2/36.1
R602	7030009280	S.RES ERJ2GEJ 391 X	T	6.8/36.6
R603	7030005090	S.RES ERJ2GEJ 104 X (100K)	T	19.6/36.4
R604	7030004980	S.RES ERJ2GEJ 101 X (100)	T	20.8/36.1
R651	7030009280	S.RES ERJ2GEJ 391 X	T	24.2/31.2
R652	7030009280	S.RES ERJ2GEJ 391 X	T	6.3/30.5
R653	7030005090	S.RES ERJ2GEJ 104 X (100K)	T	9.9/31.2
R701	7030009280	S.RES ERJ2GEJ 391 X	T	23.8/25.8
R702	7030009280	S.RES ERJ2GEJ 391 X	T	6.5/26
R703	7030005090	S.RES ERJ2GEJ 104 X (100K)	T	19.9/26
R704	7030004980	S.RES ERJ2GEJ 101 X (100)	T	7.2/27.2
R705	7030005710	S.RES ERJ2GEJ 121 X (120)	T	6.7/28.4
R706	7030004980	S.RES ERJ2GEJ 101 X (100)	T	6.3/27.2
R751	7030009280	S.RES ERJ2GEJ 391 X	T	24.2/21
R752	7030009280	S.RES ERJ2GEJ 391 X	T	5.9/20.8
R753	7030005090	S.RES ERJ2GEJ 104 X (100K)	T	10.3/20.8
R755	7030004980	S.RES ERJ2GEJ 101 X (100)	T	6.6/22.6
R756	7030005580	S.RES ERJ2GEJ 560 X (56)	T	6.6/24.2
R757	7030004980	S.RES ERJ2GEJ 101 X (100)	T	5.7/23.3
R801	7030008280	S.RES ERJ2GEJ 271 X (270)	T	27.2/14.5
R805	7030005570	S.RES ERJ2GEJ 820 X (82)	T	13.9/10.3
R806	7030005570	S.RES ERJ2GEJ 820 X (82)	T	14.2/11.7
R807	7030005570	S.RES ERJ2GEJ 820 X (82)	T	13/11.3
R808	7030003390	S.RES ERJ3GEYJ 391 V (390)	B	3.6/17.9
R810	7030005090	S.RES ERJ2GEJ 104 X (100K)	T	27.2/15.4
R841	7030005710	S.RES ERJ2GEJ 121 X (120)	T	21.2/12.5
R851	7030009280	S.RES ERJ2GEJ 391 X	T	27.1/37.3
R852	7030008280	S.RES ERJ2GEJ 271 X (270)	T	5.7/13.7
R853	7030010090	S.RES ERJ2GEJ 180 X (18)	T	6.9/14
R854	7030008280	S.RES ERJ2GEJ 271 X (270)	T	6.9/13
R855	7030003390	S.RES ERJ3GEYJ 391 V (390)	B	5.5/29.5
R901	7030005120	S.RES ERJ2GEJ 102 X (1K)	T	2.1/62.6
R902	7030005120	S.RES ERJ2GEJ 102 X (1K)	T	2.2/60.9
R903	7030005120	S.RES ERJ2GEJ 102 X (1K)	T	2.2/58.7
R951	7030003360	S.RES ERJ3GEYJ 221 V (220)	B	59.2/6.9
R952	7030004990	S.RES ERJ2GEJ 221 X (220)	B	54/9.3
R953	7030003360	S.RES ERJ3GEYJ 221 V (220)	B	59.5/3.3
R954	7030004990	S.RES ERJ2GEJ 221 X (220)	B	53.1/8.9
R955	7030004990	S.RES ERJ2GEJ 221 X (220)	B	55.2/7.7
R956	7030003360	S.RES ERJ3GEYJ 221 V (220)	B	59.2/4.9
R957	7030003360	S.RES ERJ3GEYJ 221 V (220)	B	56.6/5
R958	7030004990	S.RES ERJ2GEJ 221 X (220)	T	47.2/6.1
R959	7030003360	S.RES ERJ3GEYJ 221 V (220)	B	57.9/5.1
R960	7030003280	S.RES ERJ3GEYJ 470 V (47)	B	57.5/4.9
R961	7030004990	S.RES ERJ2GEJ 221 X (220)	T	54.6/11.6
R962	7030003860	S.RES ERJ3GE JPW V	T	51.3/21
R1051	7030003860	S.RES ERJ3GE JPW V	B	10.8/73
R1101	7030005120	S.RES ERJ2GEJ 102 X (1K)	T	40.5/52.1
R1102	7030005050	S.RES ERJ2GEJ 103 X (10K)	T	42.1/52.1
R1103	7030004980	S.RES ERJ2GEJ 101 X (100)	T	39.3/63.4
R1104	7030005050	S.RES ERJ2GEJ 103 X (10K)	T	44.2/51.2
R1105	7030004980	S.RES ERJ2GEJ 101 X (100)	T	38.7/60.9
R1106	7030007290	S.RES ERJ2GEJ 222 X (2.2K)	T	31.8/59.6
R1107	7030007290	S.RES ERJ2GEJ 222 X (2.2K)	T	28.1/59.6
R1108	7030005240	S.RES ERJ2GEJ 473 X (47K)	T	46.9/8.5
R1109	7030005240	S.RES ERJ2GEJ 473 X (47K)	T	47.9/8.5
C1	4030016950	S.CER ECJ0EB1A473K	T	17.5/4.5
C2	4030017780	S.CER ECJ0EB1E472K	T	20.9/5
C3	4030017510	S.CER ECJ0EC1H680J	T	24.8/1.7
C4	4030017780	S.CER ECJ0EB1E472K	T	22.3/4.6
C5	4030017680	S.CER ECJ0EC1H820J	T	26/2
C6	4030017510	S.CER ECJ0EC1H680J	T	27.2/1.7
C7	4030016930	S.CER ECJ0EB1A104K	T	8/4.1
C8	4030016790	S.CER ECJ0EB1C103K	T	10.1/5.7
C51	4030017780	S.CER ECJ0EB1E472K	T	33.8/6.5
C52	4030017780	S.CER ECJ0EB1E472K	T	36.1/5.3
C53	4030017780	S.CER ECJ0EB1E472K	T	36.9/9.4
C54	4030016930	S.CER ECJ0EB1A104K	T	34.9/4.4
C55	4510008580	S.ELE EEE0JA470SR	T	30.6/3.9
C56	4030016930	S.CER ECJ0EB1A104K	T	34.9/2.8
C57	4030016930	S.CER ECJ0EB1A104K	T	42.8/5
C58	4030016930	S.CER ECJ0EB1A104K	T	41/5.9
C59	4030017720	S.CER ECJ0EB1H331K	T	41.9/6.6
C60	4030017690	S.CER ECJ0EC1H121J	T	42.2/7.8
C61	4030017720	S.CER ECJ0EB1H331K	T	42.8/6.6
C62	4030016930	S.CER ECJ0EB1A104K	T	35.6/6.5
C63	4030016930	S.CER ECJ0EB1A104K	T	49.3/22.2
C64	4030017710	S.CER ECJ0EC1H181J	T	34.7/6.5
C65	4030017710	S.CER ECJ0EC1H181J	T	33.4/8.9
C101	4030017580	S.CER ECJ0EC1H060J	T	26.4/8.7
C102	4030017660	S.CER ECJ0EC1H330J	T	23.1/2.6

[DDS UNIT]

REF NO.	PARTS NO.	DESCRIPTION	M.	H/V LOCATION
C104	4030017780	S.CER ECJ0EB1E472K	T	20.9/7.8
C105	4030017460	S.CER ECJ0EB1E102K	T	24.8/6.5
C120	4030017780	S.CER ECJ0EB1E472K	T	37.3/11.5
C126	4030017780	S.CER ECJ0EB1E472K	T	23/7.4
C150	4030017780	S.CER ECJ0EB1E472K	T	44/10.7
C151	4030017780	S.CER ECJ0EB1E472K	T	46.3/13.6
C152	4030017640	S.CER ECJ0EC1H150J	T	43.3/16
C154	4030017660	S.CER ECJ0EC1H330J	T	46.6/14.6
C155	4030017600	S.CER ECJ0EC1H080C	T	46.4/16.7
C156	4030017660	S.CER ECJ0EC1H330J	T	47/18.2
C157	4030007090	S.CER C1608 CH 1H 470J-T	B	53/15.3
C202	4030017590	S.CER ECJ0EC1H070C	T	43.8/17.2
C203	4030007060	S.CER C1608 CH 1H 270J-T	B	37.8/15.9
C204	4030016930	S.CER ECJ0EB1A104K	T	35.1/20.1
C206	4030017560	S.CER ECJ0EC1H2R5B	T	43.4/21.7
C207	4030007110	S.CER C1608 CH 1H 680J-T	B	44/21.7
C208	4030009910	S.CER C1608 CH 1H 040B-T	B	40.9/21.7
C209	4030007060	S.CER C1608 CH 1H 270J-T	B	43.1/20.4
C210	4030009910	S.CER C1608 CH 1H 040B-T	B	40.8/19.8
C211	4030017460	S.CER ECJ0EB1E102K	T	42.2/17.6
C216	4030017780	S.CER ECJ0EB1E472K	T	46.3/20.8
C217	4030007120	S.CER C1608 CH 1H 820J-T	B	43.9/19.1
C218	4030011770	S.CER C1608 CH 1H 060B-T	B	43.2/17.8
C219	4030007010	S.CER C1608 CH 1H 100D-T	B	46.2/17.8
C221	4030006880	S.CER C1608 JB 1H 472K-T	B	46/15
C222	4030009910	S.CER C1608 CH 1H 040B-T	B	40.7/14.7
C223	4030006880	S.CER C1608 JB 1H 472K-T	B	46/13.4
C224	4030018630	S.CER C2012 CH 1H 472J-T	B	39.2/11.4
C225	4030006860	S.CER C1608 JB 1H 102K-T	B	38.4/19.4
C251	4030011600	S.CER C1608 JB 1E 104K-T	B	27.6/12.2
C252	4030011600	S.CER C1608 JB 1E 104K-T	B	28.7/23.5
C253	4550007090	S.TAN TEESVA 1A 226M8R	B	29.6/21.7
C254	4030011600	S.CER C1608 JB 1E 104K-T	B	29.2/12.2
C255	4550007090	S.TAN TEESVA 1A 226M8R	B	29.5/19.3
C301	4030016930	S.CER ECJ0EB1A104K	[UK] only	T 35.1/22.2
C302	4030016930	S.CER ECJ0EB1A104K	T	36.2/22.2
C303	4030016930	S.CER ECJ0EB1A104K	T	37.3/22.2
C304	4030016930	S.CER ECJ0EB1A104K	T	38.2/22.2
C305	4030016930	S.CER ECJ0EB1A104K	T	39.1/22.2
C306	4030016930	S.CER ECJ0EB1A104K	T	43.6/24.6
C307	4030016930	S.CER ECJ0EB1A104K	T	31.2/28.3
C308	4030016930	S.CER ECJ0EB1A104K	T	43.6/25.5
C309	4030016930	S.CER ECJ0EB1A104K	T	43/26.7
C310	4030016930	S.CER ECJ0EB1A104K	T	43.9/26.7
C312	4030016930	S.CER ECJ0EB1A104K	T	43.4/30.6
C314	4030017780	S.CER ECJ0EB1E472K	[UK] only	T 36.2/33.8
C317	4030011600	S.CER C1608 JB 1E 104K-T	B	44/26.1
C318	4030006880	S.CER C1608 JB 1H 472K-T	B	39.2/25.4
C319	4030011600	S.CER C1608 JB 1E 104K-T	[UK] only	B 37.4/28.4
C321	4030017420	S.CER ECJ0EC1H470J	T	51.2/30.2
C323	4030017510	S.CER ECJ0EC1H680J	T	48.6/33.3
C325	4030017660	S.CER ECJ0EC1H330J	T	48.8/35.7
C326	4030017640	S.CER ECJ0EC1H150J	T	53.1/32
C328	4030006880	S.CER C1608 JB 1H 472K-T	[EUR]	B 39.7/29.6
	4030006880	S.CER C1608 JB 1H 472K-T	[FRA]	
	4030006880	S.CER C1608 JB 1H 472K-T	[ESP]	
	4030006880	S.CER C1608 JB 1H 472K-T	[USA]	
	4030006880	S.CER C1608 JB 1H 472K-T	[EXP]	
	4030006880	S.CER C1608 JB 1H 472K-T	[ITR]	
	4030006880	S.CER C1608 JB 1H 472K-T	[KOR]	
	4030006880	S.CER C1608 JB 1H 472K-T	[AUS]	
	4030006880	S.CER C1608 JB 1H 472K-T	[CHN]	
C331	4030017390	S.CER ECJ0EC1H180J	T	46.6/44.5
C333	4030017670	S.CER ECJ0EC1H390J	T	48.4/44.5
C335	4030017390	S.CER ECJ0EC1H180J	T	50.2/44.5
C341	4030007130	S.CER C1608 CH 1H 101J-T	[EUR]	B 42.5/39.7
	4030007130	S.CER C1608 CH 1H 101J-T	[FRA]	
	4030007130	S.CER C1608 CH 1H 101J-T	[ESP]	
	4030007130	S.CER C1608 CH 1H 101J-T	[USA]	
	4030007130	S.CER C1608 CH 1H 101J-T	[EXP]	
	4030007130	S.CER C1608 CH 1H 101J-T	[ITR]	
	4030007090	S.CER C1608 CH 1H 470J-T	[UK]	
	4030007130	S.CER C1608 CH 1H 101J-T	[KOR]	
	4030007130	S.CER C1608 CH 1H 101J-T	[AUS]	
	4030007130	S.CER C1608 CH 1H 101J-T	[CHN]	
C342	4030007090	S.CER C1608 CH 1H 470J-T	B	43.7/42.1
C343	4030007140	S.CER C1608 CH 1H 121J-T	B	41.3/39
C344	4030007100	S.CER C1608 CH 1H 560J-T	B	42.7/34.3
C345	4030017660	S.CER ECJ0EC1H330J	T	45.5/37.9
C346	4030017660	S.CER ECJ0EC1H330J	T	45.7/39.7
C347	4030006860	S.CER C1608 JB 1H 102K-T	[EUR]	B 48.4/31.7
	4030006860	S.CER C1608 JB 1H 102K-T	[FRA]	
	4030006860	S.CER C1608 JB 1H 102K-T	[ESP]	
	4030006860	S.CER C1608 JB 1H 102K-T	[USA]	
	4030006860	S.CER C1608 JB 1H 102K-T	[EXP]	
	4030006860	S.CER C1608 JB 1H 102K-T	[ITR]	
	4030006860	S.CER C1608 JB 1H 102K-T	[KOR]	
	4030006860	S.CER C1608 JB 1H 102K-T	[AUS]	
	4030006860	S.CER C1608 JB 1H 102K-T	[CHN]	
C401	4030017460	S.CER ECJ0EB1E102K	T	51.1/44.5
C402	4030017460	S.CER ECJ0EB1E102K	T	52.3/48.9
C403	4030017430	S.CER ECJ0EC1H101J	T	47.9/46.1
C411	4030017400	S.CER ECJ0EC1H220J	T	48.1/49.7
C412	4030017630	S.CER ECJ0EC1H120J	T	47.7/47.3
C413				

[DDS UNIT]

REF NO.	PARTS NO.	DESCRIPTION	M.	H/V LOCATION
C454	4030017460	S.CER ECJ0EB1E102K	T	35.3/47.9
C456	4030016930	S.CER ECJ0EB1A104K	T	31.2/48
C457	4030017460	S.CER ECJ0EB1E102K	T	35.3/47
C458	4030017460	S.CER ECJ0EB1E102K	T	30.5/49.8
C459	4030017460	S.CER ECJ0EB1E102K	T	27/50.6
C460	4030017780	S.CER ECJ0EB1E472K	T	39.3/50
C461	4030006880	S.CER C1608 JB 1H 472K-T	T	30.7/42.2
C463	4030017420	S.CER ECJ0EC1H470J	T	40.6/41.8
C464	4030017690	S.CER ECJ0EC1H121J	T	41.5/40.2
C465	4030017400	S.CER ECJ0EC1H220J	T	37.7/41.8
C466	4030017570	S.CER ECJ0EC1H040B	T	38.1/40.6
C467	4030017400	S.CER ECJ0EC1H220J	T	37.2/40.6
C468	4030017360	S.CER ECJ0EC1H030B	T	29/48
C469	4030017370	S.CER ECJ0EC1H3R5B	T	29/47.1
C470	4030017380	S.CER ECJ0EC1H050B	T	29/46.2
C471	4030017380	S.CER ECJ0EC1H050B	T	35.6/43.9
C472	4030017660	S.CER ECJ0EC1H330J	T	34.7/41.8
C473	4030017570	S.CER ECJ0EC1H040B	T	34/43
C474	4030017460	S.CER ECJ0EB1E102K	T	41.6/36.7
C475	4030017460	S.CER ECJ0EB1E102K	T	30.5/36.7
C476	4030017780	S.CER ECJ0EB1E472K	T	29.6/40
C477	4030017780	S.CER ECJ0EB1E472K	T	42.4/48.8
C478	4030006880	S.CER C1608 JB 1H 472K-T	B	39.8/39.1
C479	4030006880	S.CER C1608 JB 1H 472K-T	B	38/37.9
C480	4030017630	S.CER ECJ0EC1H120J	T	35.6/41.8
C481	4030017360	S.CER ECJ0EC1H030B	T	35.6/43
C501	4030007080	S.CER C1608 CH 1H 390J-T	B	19/42.6
C502	4030007120	S.CER C1608 CH 1H 820J-T	B	18.3/44.1
C503	4030007060	S.CER C1608 CH 1H 270J-T	B	16.1/43.8
C504	4030017780	S.CER ECJ0EB1E472K	T	16.1/49.3
C505	4030017660	S.CER ECJ0EC1H330J	T	12.6/47.2
C506	4030017620	S.CER ECJ0EC1H100C	T	12.1/48.4
C507	4030017500	S.CER ECJ0EC1H560J	T	11.4/47.2
C508	4030017580	S.CER ECJ0EC1H060C	T	10.5/48.4
C509	4030017420	S.CER ECJ0EC1H470J	T	10.2/47.2
C510	4030017350	S.CER ECJ0EC1H020B	T	8.9/47.5
C511	4030017670	S.CER ECJ0EC1H390J	T	7.7/47.2
C512	4030017780	S.CER ECJ0EB1E472K	T	5.5/50.7
C513	4030017780	S.CER ECJ0EB1E472K	T	15.9/46.8
C551	4030017650	S.CER ECJ0EC1H270J	T	22.5/45.4
C552	4030017500	S.CER ECJ0EC1H560J	T	21.1/45
C553	4030017650	S.CER ECJ0EC1H270J	T	19.2/45.4
C554	4030017780	S.CER ECJ0EB1E472K	T	15.6/43.2
C555	4030017670	S.CER ECJ0EC1H390J	T	14.5/42
C556	4030017350	S.CER ECJ0EC1H020B	T	14/43.2
C557	4030017420	S.CER ECJ0EC1H470J	T	13.1/42
C558	4030017590	S.CER ECJ0EC1H070C	T	10/43.2
C559	4030017420	S.CER ECJ0EC1H470J	T	8.9/42
C560	4030017630	S.CER ECJ0EC1H120J	T	8.4/43.2
C561	4030017660	S.CER ECJ0EC1H330J	T	7.9/42
C562	4030017780	S.CER ECJ0EB1E472K	T	4.9/45.3
C563	4030017780	S.CER ECJ0EB1E472K	T	11.7/41.6
C601	4030017780	S.CER ECJ0EB1E472K	T	24.7/39.9
C602	4030017400	S.CER ECJ0EC1H220J	T	23.3/37.6
C603	4030017360	S.CER ECJ0EC1H030B	T	21.9/37.8
C604	4030017630	S.CER ECJ0EC1H120J	T	13.3/40.4
C605	4030017620	S.CER ECJ0EC1H100C	T	11.6/40.4
C606	4030017660	S.CER ECJ0EC1H330J	T	18.4/36.9
C607	4030017600	S.CER ECJ0EC1H080C	T	17.7/38.1
C608	4030017650	S.CER ECJ0EC1H270J	T	17.2/36.9
C609	4030017640	S.CER ECJ0EC1H150J	T	16.1/38.1
C610	4030017640	S.CER ECJ0EC1H150J	T	15.9/36.9
C611	4030017440	S.CER ECJ0EC1H221J	T	12.1/39.5
C612	4030017510	S.CER ECJ0EC1H680J	T	10.2/40
C613	4030017620	S.CER ECJ0EC1H100C	T	8.2/40.1
C614	4030017640	S.CER ECJ0EC1H150J	T	5.4/40.3
C615	4030017670	S.CER ECJ0EC1H390J	T	6.8/39.9
C616	4030017780	S.CER ECJ0EB1E472K	T	6.8/38.2
C617	4030017780	S.CER ECJ0EB1E472K	T	22/36.4
C618	4030017650	S.CER ECJ0EC1H270J	T	3.3/37.1
C651	4030017620	S.CER ECJ0EC1H100C	T	24.6/34.8
C652	4030017450	S.CER ECJ0EB1E271K	T	23.7/34.8
C653	4030017590	S.CER ECJ0EC1H070C	T	21.7/35.2
C654	4030017680	S.CER ECJ0EC1H820J	T	20.4/34.8
C655	4030017600	S.CER ECJ0EC1H080C	T	19.2/35.2
C656	4030017420	S.CER ECJ0EC1H470J	T	17.9/34.8
C657	4030017630	S.CER ECJ0EC1H120J	T	16.5/35.2
C658	4030017340	S.CER ECJ0EC1H010B	T	13.3/32.8
C659	4030017360	S.CER ECJ0EC1H030B	T	9.4/32.6
C660	4030017640	S.CER ECJ0EC1H150J	T	14.6/32.3
C661	4030017650	S.CER ECJ0EC1H270J	T	12.8/31.6
C662	4030017400	S.CER ECJ0EC1H220J	T	8.5/31.6
C663	4030017380	S.CER ECJ0EC1H050B	T	8/32.8
C664	4030017460	S.CER ECJ0EB1E102K	T	5.4/34.9
C665	4030017390	S.CER ECJ0EC1H180J	T	7.6/31.6
C666	4030017780	S.CER ECJ0EB1E472K	T	11.5/31.2
C701	4030017460	S.CER ECJ0EB1E102K	T	25/29.3
C702	4030017640	S.CER ECJ0EC1H150J	T	23.6/27.2
C703	4030017540	S.CER ECJ0EC1HR75B	T	22.2/27.4
C704	4030017650	S.CER ECJ0EC1H270J	T	18.7/26.4
C705	4030017350	S.CER ECJ0EC1H020B	T	18.2/27.7
C706	4030017400	S.CER ECJ0EC1H220J	T	17.5/26.4
C707	4030017570	S.CER ECJ0EC1H040B	T	16.6/27.7
C708	4030017390	S.CER ECJ0EC1H180J	T	16.3/26.4
C709	4030017590	S.CER ECJ0EC1H070C	T	13.9/30
C710	4030017500	S.CER ECJ0EC1H560J	T	12.5/29.1
C711	4030017380	S.CER ECJ0EC1H050B	T	11.9/30

[DDS UNIT]

REF NO.	PARTS NO.	DESCRIPTION	M.	H/V LOCATION
C712	4030017500	S.CER ECJ0EC1H560J	T	10.7/29.3
C713	4030017380	S.CER ECJ0EC1H050B	T	9.5/29.6
C714	4030017710	S.CER ECJ0EC1H181J	T	8.1/29.7
C715	4030017630	S.CER ECJ0EC1H120J	T	6.9/29.3
C716	4030017780	S.CER ECJ0EB1E472K	T	21.5/26
C717	4030017460	S.CER ECJ0EB1E102K	T	5.3/29.3
C751	4030017590	S.CER ECJ0EC1H070C	T	24.8/24.5
C752	4030017710	S.CER ECJ0EC1H181J	T	23.9/24.5
C753	4030017380	S.CER ECJ0EC1H050B	T	21.4/24.8
C754	4030017500	S.CER ECJ0EC1H560J	T	20.4/23.9
C755	4030017380	S.CER ECJ0EC1H050B	T	19.8/24.8
C756	4030017650	S.CER ECJ0EC1H270J	T	18.6/24.4
C757	4030017600	S.CER ECJ0EC1H080C	T	16.7/24.8
C758	4030017610	S.CER ECJ0EC1H090C	T	15/21.9
C759	4030017530	S.CER ECJ0EC1H0R5B	T	14.1/22.2
C760	4030017640	S.CER ECJ0EC1H150J	T	13.2/21.9
C761	4030017350	S.CER ECJ0EC1H020B	T	9.7/22.2
C762	4030017630	S.CER ECJ0EC1H120J	T	8.6/21.2
C763	4030017360	S.CER ECJ0EC1H030B	T	8.2/22.4
C764	4030017620	S.CER ECJ0EC1H100C	T	7.7/21.2
C765	4030017460	S.CER ECJ0EB1E102K	T	5.3/24.6
C766	4030017780	S.CER ECJ0EB1E472K	T	11.9/20.8
C802	4030017590	S.CER ECJ0EC1H070C	T	26.5/19.3
C803	4030017380	S.CER ECJ0EC1H050B	T	25.2/18.9
C804	4030017570	S.CER ECJ0EC1H040B	T	24.3/18.9
C806	4030017600	S.CER ECJ0EC1H080C	T	24.3/17.2
C807	4030017360	S.CER ECJ0EC1H030B	T	23.4/18.2
C808	4030017660	S.CER ECJ0EC1H330J	T	23/16.7
C809	4030017570	S.CER ECJ0EC1H040B	T	23/17.6
C810	4030017570	S.CER ECJ0EC1H040B	T	21.7/16.6
C811	4030017590	S.CER ECJ0EC1H070C	T	21.2/17.9
C812	4030017610	S.CER ECJ0EC1H090C	T	20.8/16.6
C813	4030017350	S.CER ECJ0EC1H020B	T	19.7/18.7
C814	4030017580	S.CER ECJ0EC1H060C	T	19.7/17
C815	4030017460	S.CER ECJ0EB1E102K	T	20.3/12.5
C816	4030017460	S.CER ECJ0EB1E102K	T	15.1/10.8
C817	4030017730	S.CER ECJ0EB1E471K	T	19/9
C824	4030017590	S.CER ECJ0EC1H070C	T	13/13
C825	4030017380	S.CER ECJ0EC1H050B	T	14.2/13.4
C826	4030017570	S.CER ECJ0EC1H040B	T	13/15.1
C827	4030017620	S.CER ECJ0EC1H100C	T	14.6/15.5
C828	4030017360	S.CER ECJ0EC1H030B	T	13.9/16.4
C829	4030017660	S.CER ECJ0EC1H330J	T	12.7/16.9
C830	4030017570	S.CER ECJ0EC1H040B	T	11.8/17.6
C831	4030017570	S.CER ECJ0EC1H040B	T	11.8/19.2
C832	4030017590	S.CER ECJ0EC1H070C	T	10.3/19.1
C833	4030017610	S.CER ECJ0EC1H090C	T	8.4/19.1
C834	4030017350	S.CER ECJ0EC1H020B	T	8/17.9
C835	4030017580	S.CER ECJ0EC1H060C	T	7/19.5
C838	4030017460	S.CER ECJ0EB1E102K	T	5.3/19.5
C839	4030017780	S.CER ECJ0EB1E472K	T	25.4/14.5
C840	4030017460	S.CER ECJ0EB1E102K	T	6.5/15.6
C841	4030006860	S.CER C1608 JB 1H 102K-T	B	5.1/15.3
C851	4030017780	S.CER ECJ0EB1E472K	T	4.5/14
C901	4030017780	S.CER ECJ0EB1E472K	T	2.4/68.4
C902	4030017430	S.CER ECJ0EC1H101J	T	16/53.2
C951	4030016930	S.CER ECJ0EB1A104K	T	52.3/38.2
C952	4030011600	S.CER C1608 JB 1E 104K-T	T	58.3/46.9
C953	4030016930	S.CER ECJ0EB1A104K	T	54/18.3
C954	4030017780	S.CER ECJ0EB1E472K	T	54.1/28.1
C955	4030016930	S.CER ECJ0EB1A104K	T	52.8/33.2
C956	4030016930	S.CER ECJ0EB1A104K	T	49.2/31
C957	4030016930	S.CER ECJ0EB1A104K	T	53.8/35.9
C958	4030017780	S.CER ECJ0EB1E472K	T	52.8/34.1
C959	4030017780	S.CER ECJ0EB1E472K	T	52.8/35
C960	4030016930	S.CER ECJ0EB1A104K	T	53.5/38.9
C961	4030016930	S.CER ECJ0EB1A104K	T	52.3/39.8
C962	4030016930	S.CER ECJ0EB1A104K	T	52.3/44.6
C963	4030016930	S.CER ECJ0EB1A104K	T	53.5/38
C964	4030017460	S.CER ECJ0EB1E102K	T	55/44.8
C966	4030016930	S.CER ECJ0EB1A104K	T	52.3/41.4
C967	4030016930	S.CER ECJ0EB1A104K	T	52.3/43
C968	4030018960	S.CER C3216 JB 1C 106MT-N	B	42/43.9
C969	4030006880	S.CER C1608 JB 1H 472K-T	B	48.2/23.1
C972	4030018970	S.CER C3225 JB 1C 226MT-N	B	42.2/35.5
C973	4030018970	S.CER C3225 JB 1C 226MT-N	B	29/2.7
C974	4030018970	S.CER C3225 JB 1C 226MT-N	B	32/2.7
C975	4550007140	S.TAN TEESVD 1C 107M12R	B	16.7/4.1
C976	4550007140	S.TAN TEESVD 1C 107M12R	B	23.5/10.5
C977	4550007140	S.TAN TEESVD 1C 107M12R	B	23.5/19.5
C978	4550007140	S.TAN TEESVD 1C 107M12R	B	32.3/10.5
C980	4030004720	S.CER C2012 JB 1H 102K-T	B	55.5/11
C981	4030016930	S.CER ECJ0EB1A104K	T	54.4/12.5
C982	4030006860	S.CER C1608 JB 1H 102K-T	B	14/67.1
C983	4030006860	S.CER C1608 JB 1H 102K-T	B	7.4/7.4
C991	4030006860	S.CER C1608 JB 1H 102K-T	B	10/68.1
C992	4030006860	S.CER C1608 JB 1H 102K-T	B	7.2/67.3
C993	4030006860	S.CER C1608 JB 1H 102K-T	B	4.2/7.4
C994	4030006860	S.CER C1608 JB 1H 102K-T	B	5.6/71.3
C995	4030006860	S.CER C1608 JB 1H 102K-T	B	2.2/59.2
C996	4030006860	S.CER C1608 JB 1H 102K-T	B	5/58.8
C997	4030006860	S.CER C1608 JB 1H 102K-T	B	2.9/55
C99				

[DDS UNIT]

REF NO.	PARTS NO.	DESCRIPTION	M.	H/V LOCATION
C1102	4030017780	S.CER ECJ0EB1E472K	T	44.2/50.3
C1104	4030017780	S.CER ECJ0EB1E472K	T	42.2/62.2
C1105	4030017780	S.CER ECJ0EB1E472K	T	40.6/59.9
C1106	4030017780	S.CER ECJ0EB1E472K	T	40.4/55.9
C1107	4030017780	S.CER ECJ0EB1E472K	T	43.3/56.9
C1108	4030017460	S.CER ECJ0EB1E102K	T	40.1/62.2
C1109	4030006880	S.CER C1608 JB 1H 472K-T	B	35.1/76.9
C1110	4030017780	S.CER ECJ0EB1E472K	T	33.5/59.6
C1111	4030017780	S.CER ECJ0EB1E472K	T	29.7/59.6
C1112	4030017780	S.CER ECJ0EB1E472K	T	38.2/63.4
C1113	4030017780	S.CER ECJ0EB1E472K	T	37.1/59.7
C1114	4030017780	S.CER ECJ0EB1E472K	T	24.4/60.6
C1115	4030017780	S.CER ECJ0EB1E472K	T	35.3/59.8
C1116	4030017460	S.CER ECJ0EB1E102K	T	23.1/63.7
C1117	4030006860	S.CER C1608 JB 1H 102K-T	B	20.9/63.9
C1151	4030017780	S.CER ECJ0EB1E472K	T	50.5/66.3
C1152	4030017780	S.CER ECJ0EB1E472K	T	46.4/66.3
C1153	4030017780	S.CER ECJ0EB1E472K	T	43.7/68.2
C1154	4030017780	S.CER ECJ0EB1E472K	T	52/66.3
C1155	4030017780	S.CER ECJ0EB1E472K	T	57.9/68.3
RL1101	6330001721	REL ATN207-K1		
J151	6510007020	CON TMP-J01X-V6		
J851	6510018450	CON TMP-S01X-B1		
J951	6510024880	S.CON 52689-3087	T	59.2/35.3
J952	6510024880	S.CON 52689-3087	T	59.2/12.4
J1001	6510003521	CON S04B-EH-S(LF)(SN)		
J1051	6450001791	CON HLJ7000-016010		
J1101	6450001641	CON TCS5044-0141177		
J1151	6450001841	CON TCS7568-4320177		
EP6	6910012350	S.BEA MMZ1608Y 102BT	B	12.9/11
EP251	6910012350	S.BEA MMZ1608Y 102BT	B	33.1/18.7
EP301	6910012350	S.BEA MMZ1608Y 102BT	B	49.7/25
EP302	6910012350	S.BEA MMZ1608Y 102BT	B	32.9/27.8
EP303	6910012350	S.BEA MMZ1608Y 102BT	B	32.9/26.1
EP305	6910012350	S.BEA MMZ1608Y 102BT	B	41/27.1
EP306	6910012350	S.BEA MMZ1608Y 102BT	B	36.6/26.3
	6910012350	S.BEA MMZ1608Y 102BT	[EUR]	
	6910012350	S.BEA MMZ1608Y 102BT	[FRA]	
	6910012350	S.BEA MMZ1608Y 102BT	[ESP]	
	6910012350	S.BEA MMZ1608Y 102BT	[USA]	
	6910012350	S.BEA MMZ1608Y 102BT	[EXP]	
	6910012350	S.BEA MMZ1608Y 102BT	[ITR]	
	6910012350	S.BEA MMZ1608Y 102BT	[KOR]	
	6910012350	S.BEA MMZ1608Y 102BT	[AUS]	
	6910012350	S.BEA MMZ1608Y 102BT	[CHN]	
EP451	6910012350	S.BEA MMZ1608Y 102BT	B	39.9/47.8
EP809	6910012350	S.BEA MMZ1608Y 102BT	B	16.6/7.1
EP951	6910012350	S.BEA MMZ1608Y 102BT	B	53.3/24.3
EP952	6910012350	S.BEA MMZ1608Y 102BT	B	50.5/21.7
EP953	6910012350	S.BEA MMZ1608Y 102BT	T	54/43.4
EP954	6910012350	S.BEA MMZ1608Y 102BT	T	54/42.1
EP955	6910012350	S.BEA MMZ1608Y 102BT	T	54.2/40
EP956	6910012350	S.BEA MMZ1608Y 102BT	T	54.6/37
EP957	6910012350	S.BEA MMZ1608Y 102BT	B	39.5/46.1
EP958	6910012350	S.BEA MMZ1608Y 102BT	B	55.9/47.4
EP959	6910012350	S.BEA MMZ1608Y 102BT	B	56.7/32.5
EP960	6910012350	S.BEA MMZ1608Y 102BT	B	56.9/28.4
EP964	6910012350	S.BEA MMZ1608Y 102BT	B	53.3/22.2
EP981	6910012350	S.BEA MMZ1608Y 102BT	T	55.3/14.2
EP1003	6910018930	S.BEA MPZ2012S601A	T	57.2/50.3
EP1004	6910018930	S.BEA MPZ2012S601A	T	53.9/50
EP1051	6910012350	S.BEA MMZ1608Y 102BT	B	20.2/66.8
EP1052	6910012350	S.BEA MMZ1608Y 102BT	B	19.2/58.7
EP1100	6910012350	S.BEA MMZ1608Y 102BT	B	38.7/63.4
EP1101	6910012350	S.BEA MMZ1608Y 102BT	T	27.5/63.3
EP1102	6910012350	S.BEA MMZ1608Y 102BT	T	34.4/62.4
EP1103	6910012350	S.BEA MMZ1608Y 102BT	T	51.1/69.2
EP1104	6910012350	S.BEA MMZ1608Y 102BT	T	56.1/69.2
EP1105	6910014730	S.BEA MPZ2012S331A-T	B	41/67.9
EP1106	6910014730	S.BEA MPZ2012S331A-T	B	34.7/61.8
EP1107	6910014730	S.BEA MPZ2012S331A-T	B	31.4/61.8
EP1108	6910014730	S.BEA MPZ2012S331A-T	B	27/73.6
MP201	8510017200	PLA 2427 A-SHIELD PLATE Y800	B	43/14.7

M.=Mounted side (T: Mounted on the Top side, B: Mounted on the Bottom side)
S.=Surface mount

BOARD LAYOUTS

The combination of this side and the bottom side shows the board layout in the same configuration as the actual P.C.Board.

• MAIN UNIT (TOP VIEW)

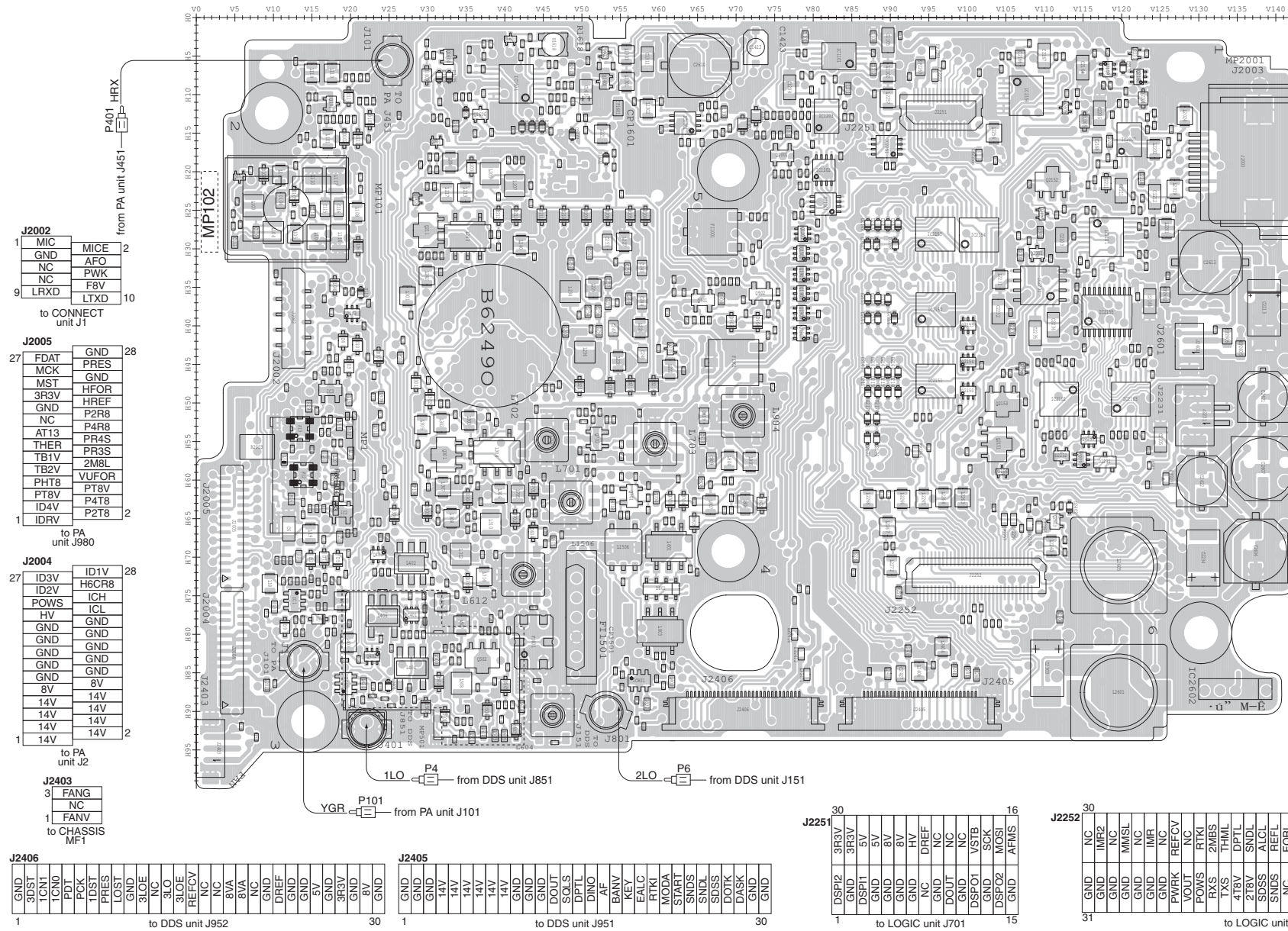

J2002

1	MIC	2	MICE
	GND		AFO
	NC		PWK
	NC		F8V
9	LRXD	10	LTXD

to CONNECT unit J1

J2005

27	FDAT	28	GND
	MCK		PRES
	MST		GND
	3R3V		HFOR
	NC		HREF
	AT13		P2R8
	THER		P4R8
	TB1V		PR3S
	TB2V		2M8L
	PHT8		VUFOR
	PT8V		PT8V
	ID4V		P4T8
1	IDRV	2	P2T8

to PA unit J980

J2004

27	ID3V	28	ID1V
	ID2V		H6CR8
	POWS		ICH
	HV		ICL
	GND		GND
	GND		GND
	GND		GND
	GND		GND
	GND		GND
	8V		8V
	14V		14V
	14V		14V
	14V		14V
1	14V	2	14V

to PA unit J2

J2403

3	FANG
	NC
1	FANV

to CHASSIS MF1

J2406

1	GND	30	GND
	3DST		3DST
	TCN1		TCN1
	TCN0		TCN0
	PCK		PCK
	TDST		TDST
	PRES		PRES
	LOST		LOST
	GND		GND
	3LOE		3LOE
	3LO		3LO
	3LOE		3LOE
	NC		NC
	8VA		8VA
	8VA		8VA
	NC		NC
	NC		NC
	GND		GND
	GND		GND
	GND		GND
	5V		5V
	GND		GND
	3R3V		3R3V
	GND		GND
	8V		8V
	GND		GND

to DDS unit J952

J2405

1	GND	30	GND
	GND		GND
	14V		14V
	14V		14V
	14V		14V
	14V		14V
	14V		14V
	GND		GND
	GND		GND
	GND		GND
	DOUT		DOUT
	SOA5		SOA5
	DIND		DIND
	AF		AF
	BANV		BANV
	KEY		KEY
	EALC		EALC
	RTKI		RTKI
	MODA		MODA
	START		START
	SNDS		SNDS
	SNDL		SNDL
	SDSS		SDSS
	DOTK		DOTK
	DASK		DASK
	GND		GND
	GND		GND

to DDS unit J951

J2251

1	3R3V	15	3R3V
	GND		GND
	5V		5V
	5V		5V
	8V		8V
	8V		8V
	HV		HV
	DREF		DREF
	NC		NC
	DOUT		DOUT
	NC		NC
	VSTB		VSTB
	DSPOT		DSPOT
	GND		GND
	GND		GND
	SOCK		SOCK
	MOSI		MOSI
	AFMS		AFMS
	GND		GND

to LOGIC unit J701

J2252

31	NC	60	1
	IMR2		IMR2
	GND		GND
	MMSL		MMSL
	NC		NC
	IMR		IMR
	NC		NC
	REFCV		REFCV
	PWRK		PWRK
	VOUT		VOUT
	NC		NC
	RTKI		RTKI
	POWS		POWS
	2MBS		2MBS
	TXS		TXS
	THML		THML
	DPTL		DPTL
	4TRV		4TRV
	2TRV		2TRV
	SDSS		SDSS
	ALCL		ALCL
	SNDS		SNDS
	REFL		REFL
	FORL		FORL
	NC		NC
	MCK		MCK
	MUDL		MUDL
	MDT		MDT
	KEY		KEY
	START		START
	NC		NC
	CIVE		CIVE
	NC		NC
	LVXD		LVXD
	LOSS		LOSS
	PERP		PERP
	WFAI		WFAI
	LCAN		LCAN
	DASK		DASK
	DOTK		DOTK
	PCK		PCK
	PDT		PDT
	SOSS		SOSS
	3DST		3DST
	MMOK		MMOK
	VDL		VDL

to LOGIC unit J651

• VR UNIT (TOP VIEW)

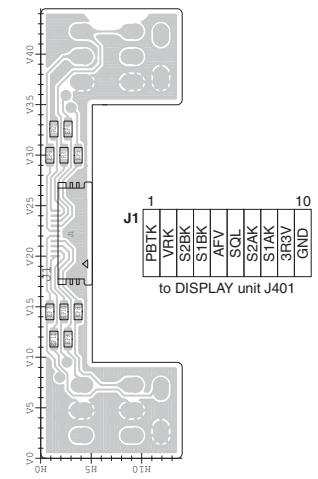

J1

1	PBTK	10	GND
	VRK		SZBK
	SZBK		S1BK
	S1BK		AFV
	AFV		SOL
	SOL		SZAK
	SZAK		S1AK
	S1AK		3R3V
	3R3V		GND

to DISPLAY unit J401

J2003

1	8VM
	U/DM
	MAFM
	SENM
	MCEM
	MICM
	GND
8	SQSM

to Microphone

J2601

2	ESPE
1	ISPO

to CHASSIS SP1

J2231

2	YGND
1	YY-VIDEO

to CONNECT unit W1

• DRIVER UNIT (TOP VIEW)

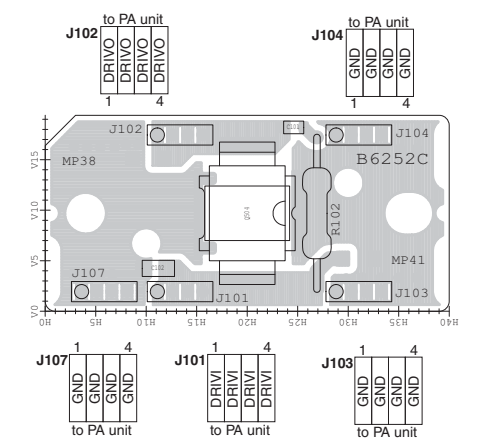

J102

1	DRIVO	4	DRIVO
	DRIVO		DRIVO
	DRIVO		DRIVO
	DRIVO		DRIVO

to PA unit

J104

1	GND	4	GND
	GND		GND
	GND		GND
	GND		GND

to PA unit

J107

1	GND	4	GND
	GND		GND
	GND		GND
	GND		GND

to PA unit

J101

1	DRIV	4	DRIV
	DRIV		DRIV
	DRIV		DRIV
	DRIV		DRIV

to PA unit

J103

1	GND	4	GND
	GND		GND
	GND		GND
	GND		GND

to PA unit

• CONNECT UNIT (TOP VIEW)

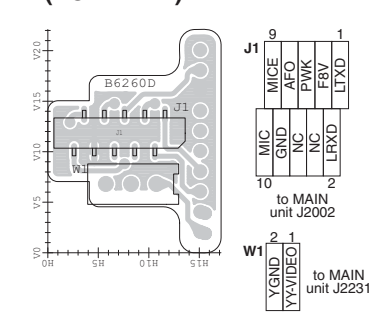

J1

9	MICE	1	MICE
	AFO		AFO
	NC		NC
	NC		NC
	LRXD		LRXD
10		2	

to MAIN unit J2002

W1

2	YGND	1	YGND
	YY-VIDEO		YY-VIDEO

to MAIN unit J2231

The combination of this side and the bottom side shows the board layout in the same configuration as the actual P.C.Board.

• VR UNIT
(BOTTOM VIEW)

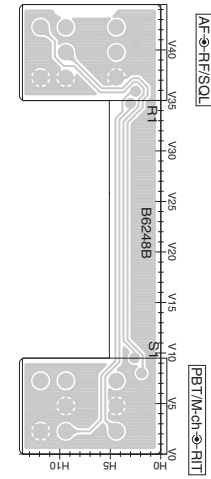

• DRIVER UNIT
(BOTTOM VIEW)

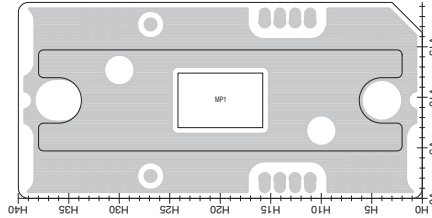

• MAIN UNIT
(BOTTOM VIEW)

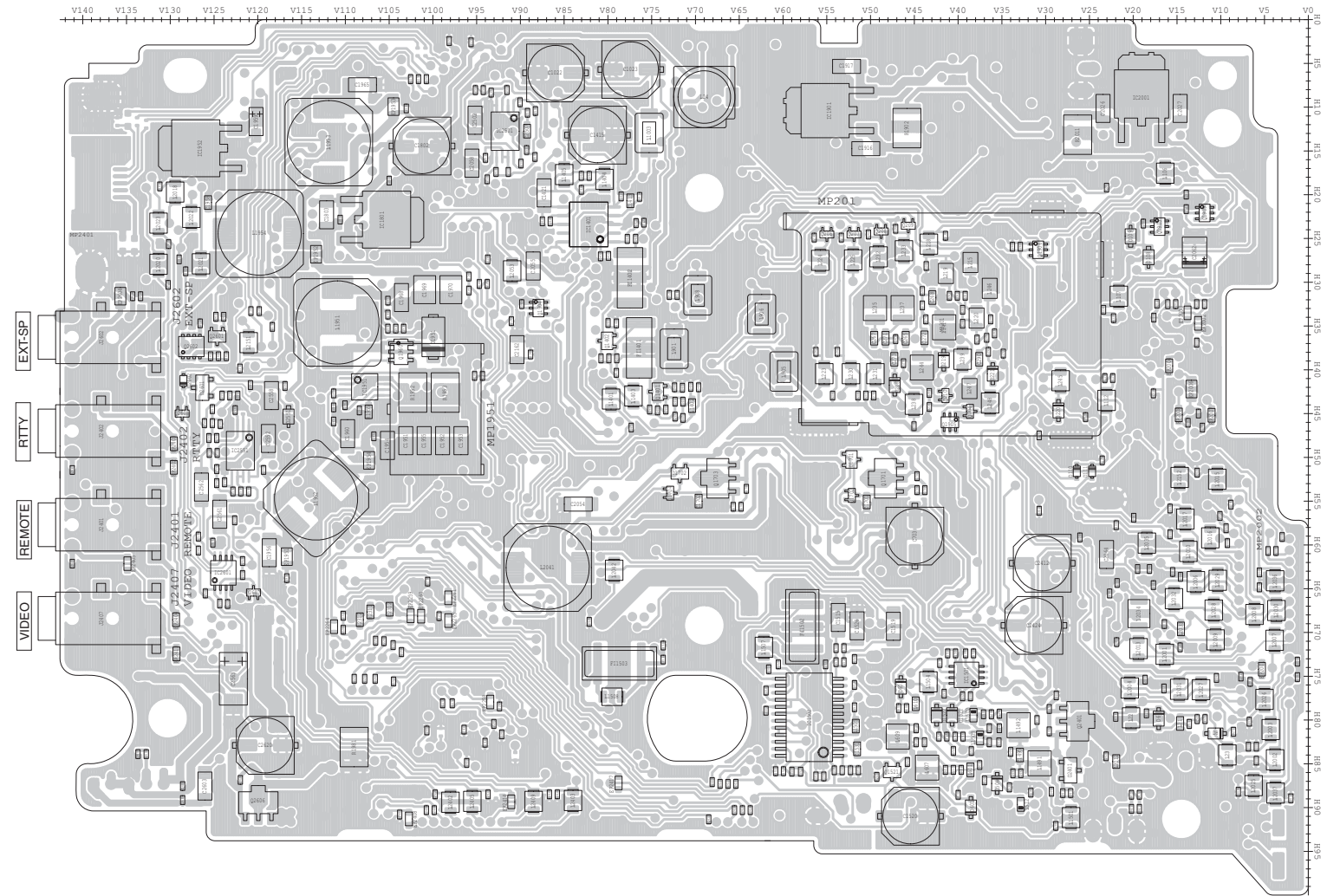

• CONNECT UNIT
(BOTTOM VIEW)

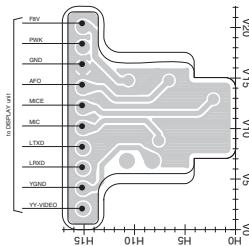

VOLTAGE DIAGRAM

• DISPLAY UNIT

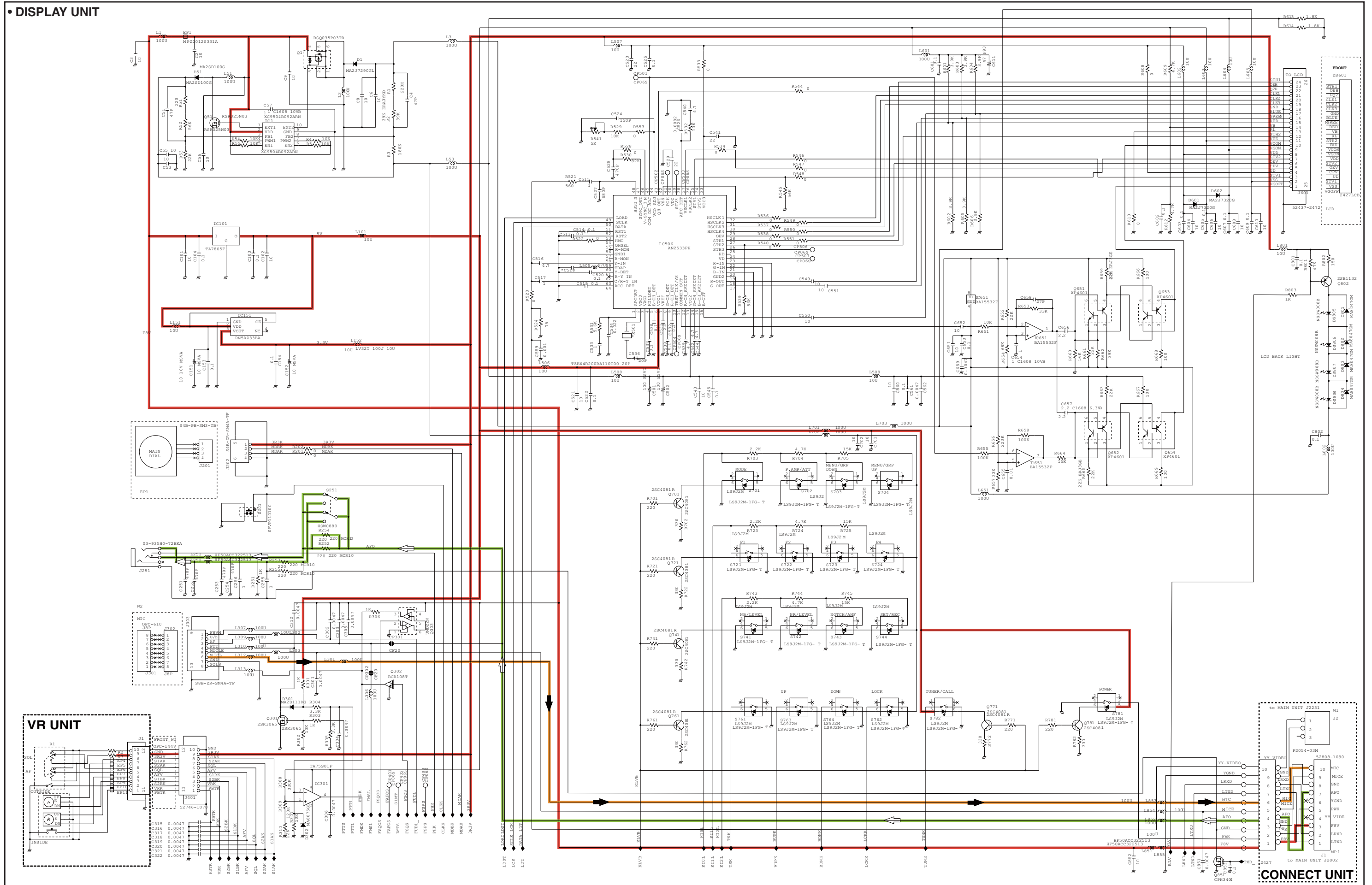

*; Refer to "PARTS LIST."

• LOGIC UNIT (3/3)

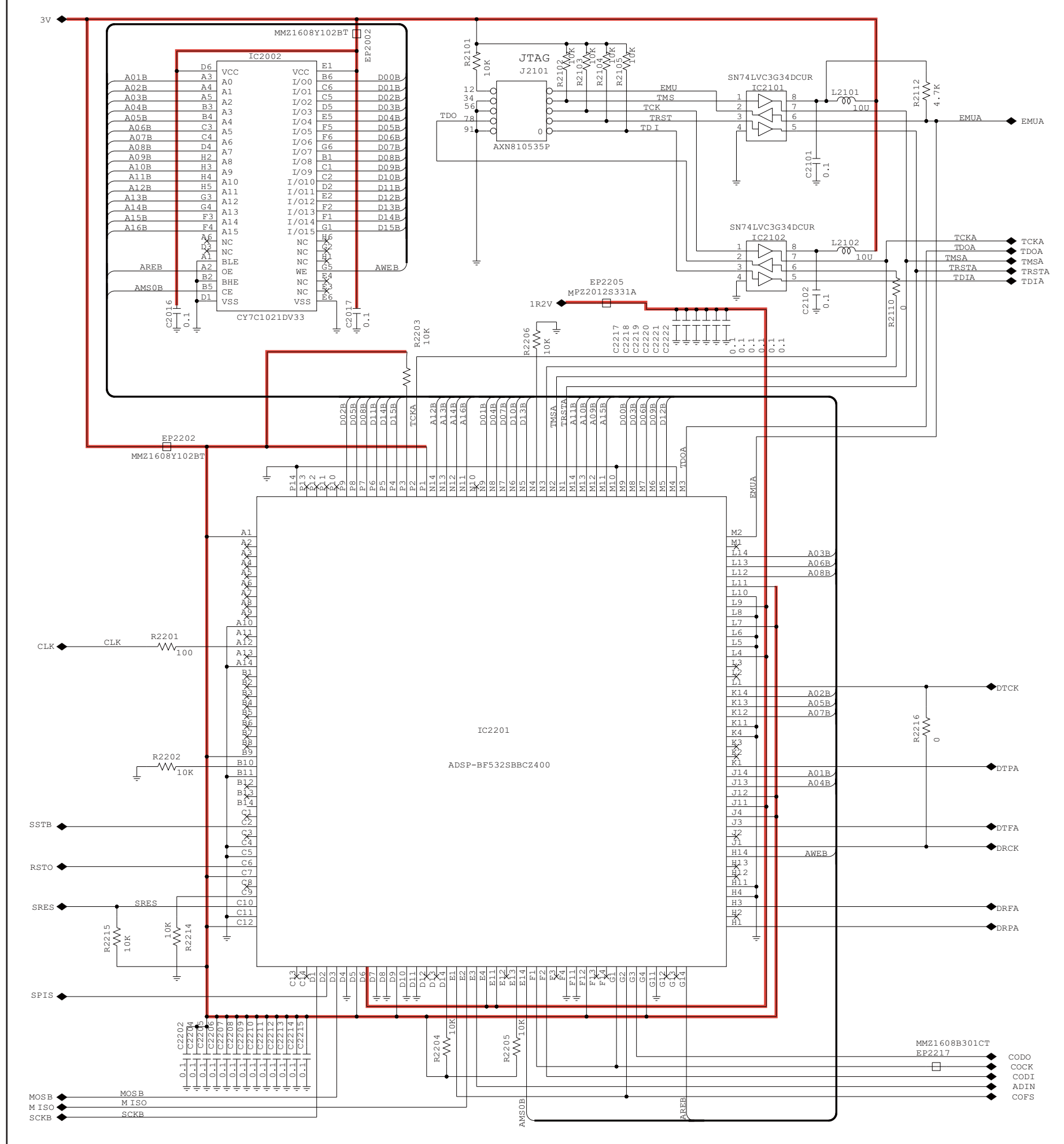

*; Refer to "PARTS LIST."

• MAIN UNIT (Left side)

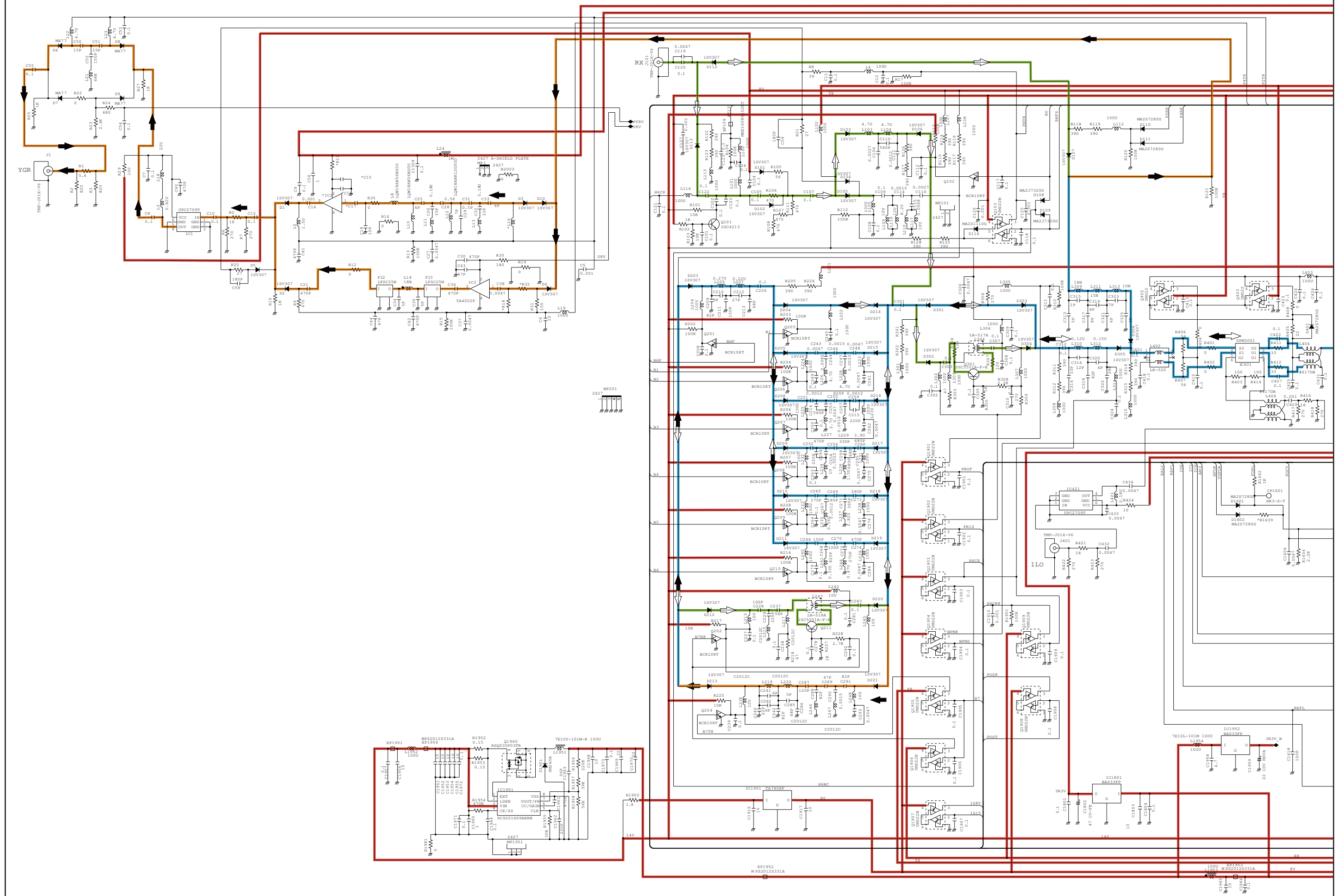

*; Refer to "PARTS LIST."

• PA UNIT (1/2)

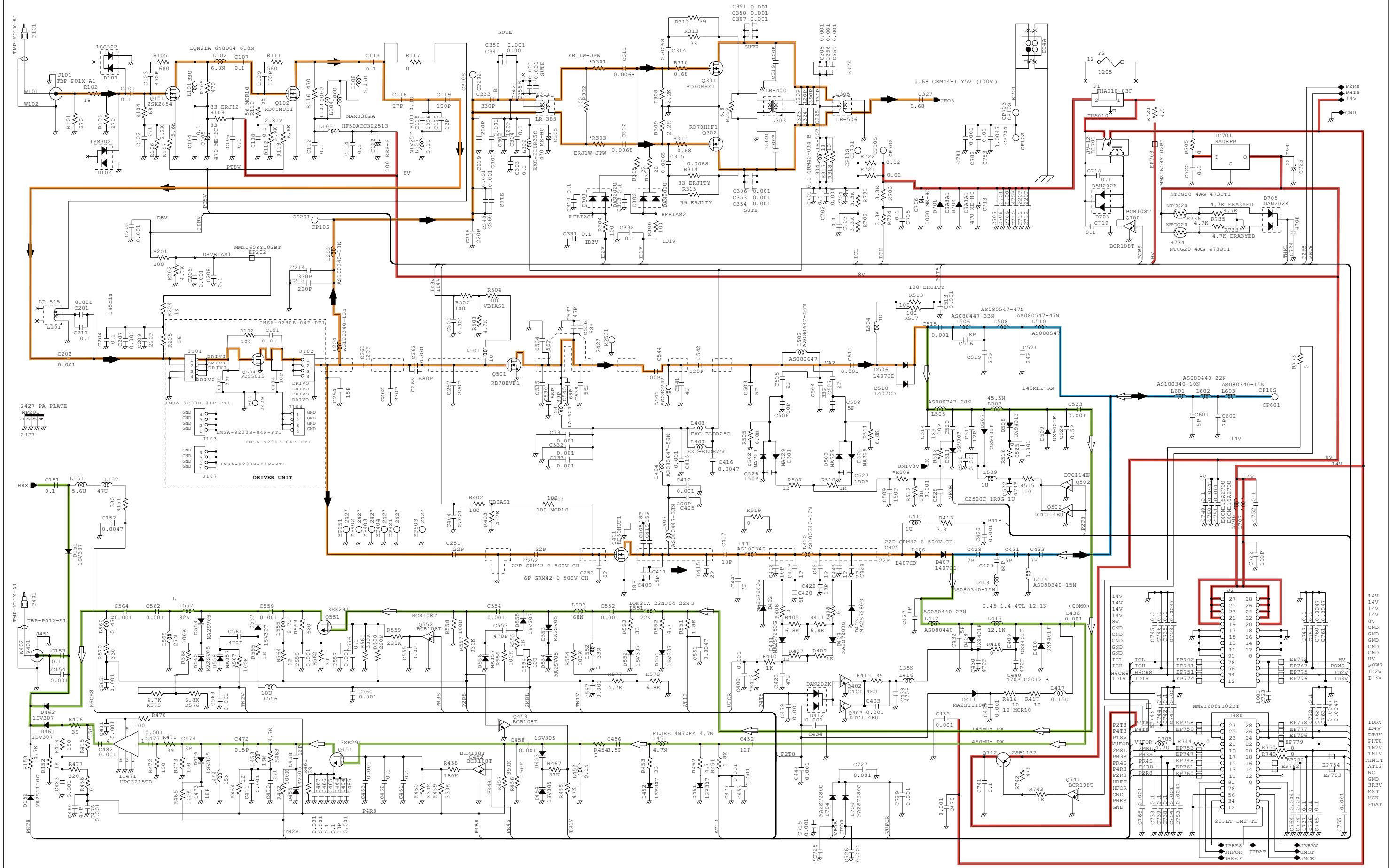

*; Refer to "PARTS LIST."

• PA UNIT (2/2)

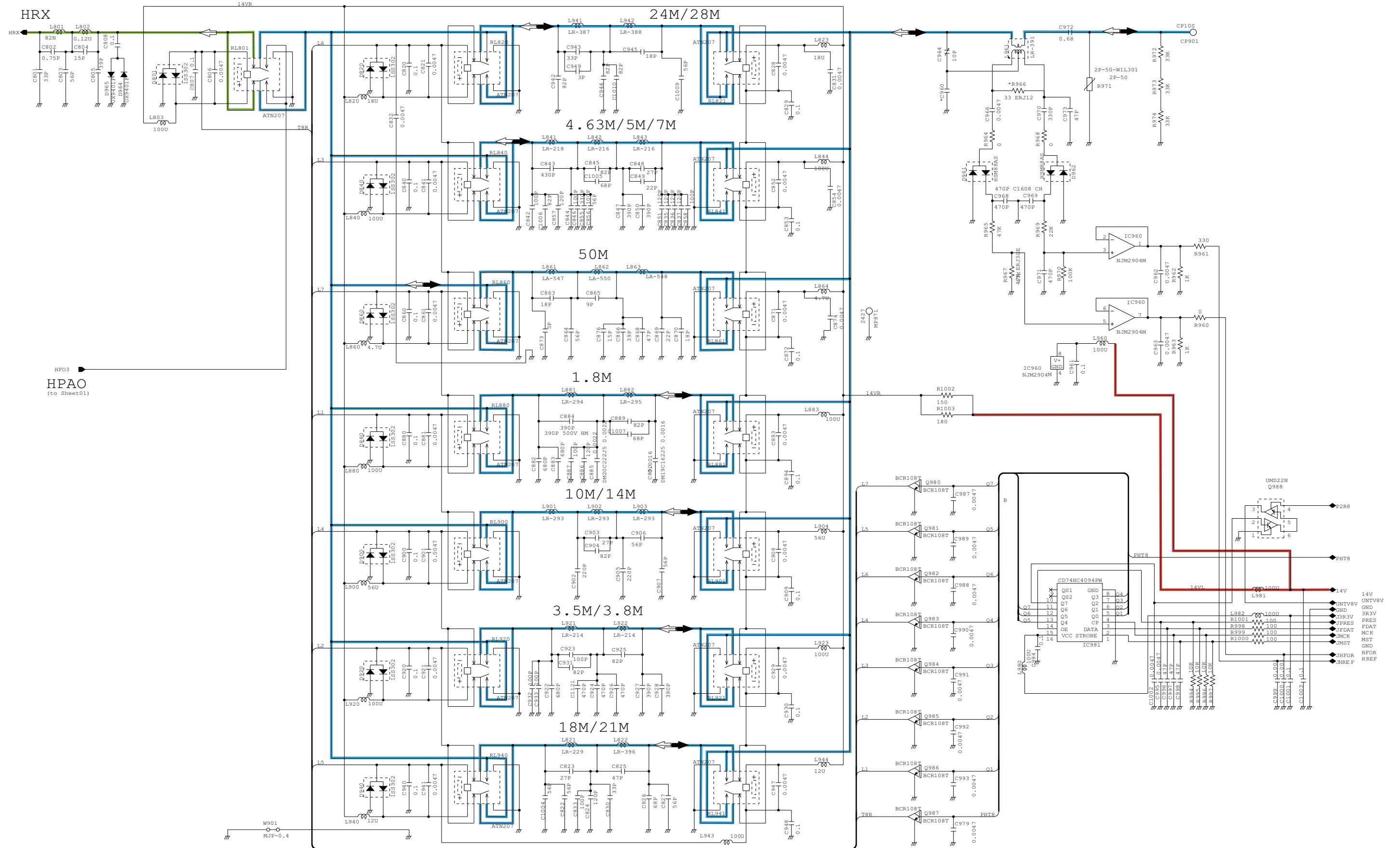

Dec. 2008



SERVICE MANUAL ADDENDUM

IC-7000

CONTENTS

PARTS LIST	1
BOARD LAYOUTS (LOGIC AND PA UNITS)	26
VOLTAGE DIAGRAM	28

PARTS LIST

[MAIN UNIT]

REF NO.	PARTS NO.	DESCRIPTION	M.	H/V LOCATION
IC401	1190002052	SPM5001-TL-E (7000)	[EUR]	T 77.5/27.9
	1190002052	SPM5001-TL-E (7000)	[ESP]	
	1190002052	SPM5001-TL-E (7000)	[USA]	
	1190002052	SPM5001-TL-E (7000)	[EXP]	
	1190002052	SPM5001-TL-E (7000)	[ITR]	
	1190002052	SPM5001-TL-E (7000)	[UK]	
	1190002052	SPM5001-TL-E (7000)	[CHN]	
IC1	1110004080	S.IC UPC2709T-E3		T 75.6/12.7
IC2	1110004101	S.IC TA4001F (TE85L,F)		T 64/18.8
IC3	1110004091	S.IC TA4002F (TE85L,F)		T 48.3/17.4
IC401	1190002051	S.IC SPM5001-TL-E	[FRA]	T 77.5/27.9
	1190002051	S.IC SPM5001-TL-E	[KOR]	
	1190002051	S.IC SPM5001-TL-E	[AUS]	
IC421	1110004080	S.IC UPC2709T-E3		T 86.4/19.4
IC801	1110004080	S.IC UPC2709T-E3		T 86/57.4
IC1101	1110006730	S.IC NJM2594V-TE1-#ZZZB		T 5/83.3
IC1201	1130006221	S.IC TC4W53FU(TE12L,F)		T 24.2/81.6
IC1202	1130006221	S.IC TC4W53FU(TE12L,F)		T 19.8/81.4
IC1203	1110006570	S.IC TS462CPT		T 12.8/81.7
IC1301	1110005461	S.IC TA4107F(TE12L,F)		T 13.7/63.4
IC1401	1110006541	S.IC LA1225M-TLM-E		B 23.4/82.2
IC1501	1110006530	S.IC TA4019F(TE12L,F)		B 74.8/39
IC1502	1110005040	S.IC M52342FP 600C		B 79.7/57
IC1601	1110005320	S.IC NJM13403V-TE1-#ZZZB		T 8.6/41.5
IC1801	1180002020	S.REG BA033FP-E2		B 22.8/106.5
IC1901	1180001251	S.IC TA7808F(TE16L,Q)		B 10.4/55.2
IC1951	1190002120	S.IC XC9201D09AKR		B 41.9/107.8
IC1952	1180002020	S.REG BA033FP-E2		B 14.7/125.8
IC2001	1180001251	S.IC TA7808F(TE16L,Q)		B 8.5/19
IC2007	1110006570	S.IC TS462CPT		T 15.8/121
IC2101	1110005320	S.IC NJM13403V-TE1-#ZZZB		T 28.5/118
IC2102	1110005320	S.IC NJM13403V-TE1-#ZZZB		T 49.5/111.9
IC2103	1110005140	S.IC NJM3403AV-TE1-#ZZZB		T 49.5/121.2
IC2151	1130012720	S.IC CD74HC4094PWR		T 47.1/95.9
IC2152	1130012720	S.IC CD74HC4094PWR		T 37.9/95.9
IC2153	1130012720	S.IC CD74HC4094PWR		T 28.1/95.8
IC2154	1130012720	S.IC CD74HC4094PWR		T 28.2/101.5
IC2155	1110006680	S.IC BH2221FV-E2		T 38.2/118.1
IC2156	1130009100	S.IC BU4052BCFV-E2		T 10.1/107.6
IC2231	1110006640	S.IC NJM2244M-TE1-#ZZZB		T 34.7/109.4
IC2251	1130008511	S.IC TC7W53FU(TE12L,F)		T 16.7/89.5
IC2501	1110006570	S.IC TS462CPT		B 12.7/91.7
IC2551	1110006570	S.IC TS462CPT		B 49.2/122
IC2601	1130006221	S.IC TC4W53FU(TE12L,F)		B 63.2/123.9
IC2602	1110003091	IC LA4425A-E		
Q101	1530003091	S.TRA 2SC4213-B(TE85R,F)		T 11.2/17.5
Q102	1590003940	S.TRA RN1105(TE85L,F)		T 20.7/5.6
Q103	1590003930	S.TRA UMD22N TR		T 38.4/20.2
Q201	1590003940	S.TRA RN1105(TE85L,F)		T 16.1/31.1
Q202	1590003940	S.TRA RN1105(TE85L,F)		T 23.5/28.5
Q204	1590003940	S.TRA RN1105(TE85L,F)		B 44.7/38.6
Q205	1590003940	S.TRA RN1105(TE85L,F)		T 42.9/61.5
Q206	1590003940	S.TRA RN1105(TE85L,F)		B 24.5/55
Q207	1590003940	S.TRA RN1105(TE85L,F)		B 24.5/51.9
Q208	1590003940	S.TRA RN1105(TE85L,F)		B 24.2/48.8
Q209	1590003940	S.TRA RN1105(TE85L,F)		B 23.5/45.7
Q210	1590003940	S.TRA RN1105(TE85L,F)		B 42.9/41.4
Q211	1530003851	S.TRA 2SC5551F-TD-E		T 27.6/30.1
Q301	1530003851	S.TRA 2SC5551F-TD-E		T 56.7/32.4
Q402	1590003930	S.TRA UMD22N TR		T 82.8/22.8
Q403	1590003930	S.TRA UMD22N TR		T 69.7/23.6
Q502	1530003851	S.TRA 2SC5551F-TD-E		T 83/37.1
Q701	1580000780	S.FET 3SK195(TE85L,F)		T 62/56.5
Q702	1580000780	S.FET 3SK195(TE85L,F)		T 54.6/51.8
Q901	1580000780	S.FET 3SK195(TE85L,F)		T 36.6/65.7
Q902	1580000780	S.FET 3SK195(TE85L,F)		T 35.9/73.2
Q1001	1580000780	S.FET 3SK195(TE85L,F)		T 17.9/76
Q1201	1590003930	S.TRA UMD22N TR		T 28/78.6
Q1401	1530002060	S.TRA 2SC4081 T106 R		B 42.5/74.3
Q1402	1530002060	S.TRA 2SC4081 T106 R		B 36.7/80.1
Q1501	1590003530	S.TRA BCR08PN		T 30.6/78.5
Q1521	1530002060	S.TRA 2SC4081 T106 R		B 86.6/48.6
Q1601	1530003091	S.TRA 2SC4213-B(TE85R,F)		T 8.3/52.9
Q1602	1590001870	S.TRA DTA114EE TL		T 4.5/53
Q1603	1590003940	S.TRA RN1105(TE85L,F)		T 2.8/40.7
Q1604	1510000771	S.TRA 2SA1586-GR(TE85L,F)		T 5.1/32.7
Q1606	1560001260	S.FET 2SK3018 T106		T 12.5/36.8
Q1701	1540000441	S.TRA 2SD1619T-TD-E		B 52.4/48.2
Q1702	1590003940	S.TRA RN1105(TE85L,F)		B 54.3/52.1
Q1703	1540000441	S.TRA 2SD1619T-TD-E		B 52.4/67.4
Q1704	1590003940	S.TRA RN1105(TE85L,F)		B 54.1/72.9
Q1901	1590003930	S.TRA UMD22N TR		T 35.8/78.5
Q1902	1590003930	S.TRA UMD22N TR		T 33.3/78.5
Q1903	1590003930	S.TRA UMD22N TR		B 23.6/17
Q1904	1590003930	S.TRA UMD22N TR		B 32.9/87.9
Q1905	1590003930	S.TRA UMD22N TR		B 46/40.9
Q1906	1590003930	S.TRA UMD22N TR		B 26.3/30.8
Q1907	1590003930	S.TRA UMD22N TR		T 40.9/78.5
Q1908	1590003930	S.TRA UMD22N TR		T 38.3/78.5

[MAIN UNIT]

REF NO.	PARTS NO.	DESCRIPTION	M.	H/V LOCATION
Q1909	1590003930	S.TRA UMD22N TR		B 22.1/11.8
Q1960	1550000090	S.FET RSQ035P03TR		B 37.9/103.6
Q2150	1590003930	S.TRA UMD22N TR		T 48.4/100.1
Q2151	1520000460	S.TRA 2SB1132 T100 R		T 55.3/103.8
Q2152	1520000460	S.TRA 2SB1132 T100 R		T 21.3/11.1
Q2153	1520000460	S.TRA 2SB1132 T100 R		T 49.8/104.5
Q2154	1590003930	S.TRA UMD22N TR		T 44.7/100.1
Q2155	1590003930	S.TRA UMD22N TR		T 39.9/100.1
Q2156	1590003940	S.TRA RN1105(TE85L,F)		T 58.9/104.5
Q2157	1590003940	S.TRA RN1105(TE85L,F)		T 25.4/109.7
Q2158	1590003940	S.TRA RN1105(TE85L,F)		T 45.5/107.1
Q2159	1590003930	S.TRA UMD22N TR		T 6.7/118.2
Q2160	1590003930	S.TRA UMD22N TR		T 7.7/122.2
Q2231	1590003940	S.TRA RN1105(TE85L,F)		T 4.7/121.7
Q2232	1590003930	S.TRA UMD22N TR		T 57.3/114.8
Q2233	1590003930	S.TRA UMD22N TR		T 54.7/115.7
Q2301	1530002060	S.TRA 2SC4081 T106 R		T 30.6/109
Q2401	1540000441	S.TRA 2SD1619T-TD-E		B 80.1/26.4
Q2601	1560001260	S.FET 2SK3018 T106		B 36.2/124.6
Q2602	1560001221	S.FET ECH8301-TL-E		B 37.3/127.6
Q2603	1530002060	S.TRA 2SC4081 T106 R		T 65.3/111.3
Q2605	1590003940	S.TRA RN1105(TE85L,F)		T 11.7/112.7
Q2606	1540000451	S.TRA 2SD1623T-TD-E		B 89.5/119.9
Q2607	1590003940	S.TRA RN1105(TE85L,F)		B 65.4/120.5
Q2608	1590003940	S.TRA RN1105(TE85L,F)		B 45/128.6
D1	1750000581	S.DIO 1SV307(TPH3,F)		T 70.1/16.6
D2	1750000581	S.DIO 1SV307(TPH3,F)		T 70.3/14.8
D3	1750000581	S.DIO 1SV307(TPH3,F)		T 45.2/19.8
D4	1750000581	S.DIO 1SV307(TPH3,F)		T 41.9/19
D5	1750000581	S.DIO 1SV307(TPH3,F)		T 70.3/18.3
D6	1790000620	S.DIO MA77(TX)		B 79.8/17.1
D7	1790000620	S.DIO MA77(TX)		T 78/15.8
D8	1790000620	S.DIO MA77(TX)		B 81.5/10.6
D9	1790000620	S.DIO MA77(TX)		T 79/11.5
D10	1750000581	S.DIO 1SV307(TPH3,F)		T 42.4/20.9
D101	1750000581	S.DIO 1SV307(TPH3,F)		T 13.3/22.5
D102	1750000581	S.DIO 1SV307(TPH3,F)		T 15.7/19.2
D103	1750000581	S.DIO 1SV307(TPH3,F)		T 20.3/8.7
D104	1750000581	S.DIO 1SV307(TPH3,F)		T 34.7/17.9
D105	1750000581	S.DIO 1SV307(TPH3,F)		T 23.1/12.7
D106	1750000581	S.DIO 1SV307(TPH3,F)		T 29.6/21
D107	1750000581	S.DIO 1SV307(TPH3,F)		T 44/23.6
D108	1750000950	S.DIO MA732(TX)		B 27.1/18.2
D109	1750000950	S.DIO MA732(TX)		B 24.7/20.3
D110	1790001240	S.DIO MA2S728-(TX)		B 51.6/26.4
D111	1790001240	S.DIO MA2S728-(TX)		B 51.6/24.7
D112	1750000581	S.DIO 1SV307(TPH3,F)		T 15.7/20.9
D113	1750000581	S.DIO 1SV307(TPH3,F)		T 10.2/19.7
D114	1790001250	S.DIO MA2S111-(TX)		T 35.7/21.3
D203	1750000581	S.DIO 1SV307(TPH3,F)		T 19.3/35.7
D204	1750000581	S.DIO 1SV307(TPH3,F)		T 25.7/58.2
D205	1750000581	S.DIO 1SV307(TPH3,F)		T 25.7/56.3
D208	1750000581	S.DIO 1SV307(TPH3,F)		T 25.7/53.4
D209	1750000581	S.DIO 1SV307(TPH3,F)		T 25.7/50.6
D210	1750000581	S.DIO 1SV307(TPH3,F)		T 25.7/47.7
D211	1750000581	S.DIO 1SV307(TPH3,F)		T 25.7/44.8
D212	1750000581	S.DIO 1SV307(TPH3,F)		T 25.7/39.2
D213	1750000581	S.DIO 1SV307(TPH3,F)		T 25.7/41.5
D214	1750000581	S.DIO 1SV307(TPH3,F)		T 47.7/59.3
D215	1750000581	S.DIO 1SV307(TPH3,F)		T 47.7/56.3
D216	1750000581	S.DIO 1SV307(TPH3,F)		T 47.9/53.6
D217	1750000581	S.DIO 1SV307(TPH3,F)		T 47.8/49.7
D218	1750000581	S.DIO 1SV307(TPH3,F)		B 41.7/47.2
D219	1750000581	S.DIO 1SV307(TPH3,F)		B 38.9/41.6
D220	1750000581	S.DIO 1SV307(TPH3,F)		B 44.6/28.5
D221	1750000581	S.DIO 1SV307(TPH3,F)		B 40.4/36
D301	1750000581	S.DIO 1SV307(TPH3,F)		T 47.3/28.5
D302	1750000581	S.DIO 1SV307(TPH3,F)		T 49.5/30.3
D303	1750000581	S.DIO 1SV307(TPH3,F)		T 64.1/29.9
D304	1750000581	S.DIO 1SV307(TPH3,F)		T 62.4/35.2
D305	1750000581	S.DIO 1SV307(TPH3,F)		T 73.3/35.2
D306	1750000581	S.DIO 1SV307(TPH3,F)		T 64.5/25.7
D401	1790001240	S.DIO MA2S728-(TX)		T 86.6/24.9
D501	1750000531	S.DIO 1SV271(TPH3,F)		T 90.6/32.2
D502	1750000581	S.DIO 1SV307(TPH3,F)		T 86.2/31.4
D503	1750000581	S.DIO 1SV307(TPH3,F)		T 89.4/29.7
D504	1750000531	S.DIO 1SV271(TPH3,F)		T 89.7/37.7
D505	1750000581	S.DIO 1SV307(TPH3,F)		T 86.7/40.1
D506	1750000581	S.DIO 1SV307(TPH3,F)		B 87.2/35.5
D601	1750000581	S.DIO 1SV307(TPH3,F)		B 90/38.5
D602	1750000581	S.DIO 1SV307(TPH3,F)		T 92.4/41.5
D603	1750000581	S.DIO 1SV307(TPH3,F)		B 76.2/46.5
D604	1			

[MAIN UNIT]

REF NO.	PARTS NO.	DESCRIPTION	M.	H/V LOCATION
D803	1750000581	S.DIO 1SV307(TPH3,F)	T	65.5/64.6
D903	1750000581	S.DIO 1SV307(TPH3,F)	T	39.5/69.4
D904	1750000581	S.DIO 1SV307(TPH3,F)	T	39.5/72.8
D1301	1750000581	S.DIO 1SV307(TPH3,F)	T	12.8/72.6
D1302	1750000581	S.DIO 1SV307(TPH3,F)	T	13.9/70.8
D1521	1750000531	S.DIO 1SV271(TPH3,F)	B	79.4/40.7
D1522	1750000531	S.DIO 1SV271(TPH3,F)	B	79.4/42.4
D1601	1790001240	S.DIO MA2S728-(TX)	T	15.1/48.7
D1602	1790001240	S.DIO MA2S728-(TX)	T	18.3/53.1
D1604	1790001250	S.DIO MA2S111-(TX)	T	7.7/31.5
D1605	1790001250	S.DIO MA2S111-(TX)	T	7.7/32.8
D1606	1790001250	S.DIO MA2S111-(TX)	T	14.1/44.8
D1607	1790001250	S.DIO MA2S111-(TX)	T	14.1/43.5
D1608	1790001250	S.DIO MA2S111-(TX)	T	14.1/42.2
D1609	1790001330	S.ZEN MA8036-L(TX)	T	7.5/29.9
D1610	1790001250	S.DIO MA2S111-(TX)	T	12.3/34.9
D1701	1790001670	S.DIO RB706F-40T106	B	50.2/52.2
D1702	1790001670	S.DIO RB706F-40T106	B	51.8/71.8
D1951	1750001110	S.DIO SM240A-T	B	36.2/99.9
D2151	1790001250	S.DIO MA2S111-(TX) [USA]	T	39/87.1
	1790001250	S.DIO MA2S111-(TX) [KOR]		
	1790001250	S.DIO MA2S111-(TX) [AUS]		
D2153	1790001250	S.DIO MA2S111-(TX) [USA]	T	36.5/87.1
	1790001250	S.DIO MA2S111-(TX) [KOR]		
D2154	1790001250	S.DIO MA2S111-(TX)	T	36.5/88.4
D2155	1790001250	S.DIO MA2S111-(TX)	T	36.6/89.7
D2156	1790001250	S.DIO MA2S111-(TX)	T	39/90.5
D2157	1790001250	S.DIO MA2S111-(TX) [EUR]	T	48.5/87.1
	1790001250	S.DIO MA2S111-(TX) [ESP]		
	1790001250	S.DIO MA2S111-(TX) [USA]		
	1790001250	S.DIO MA2S111-(TX) [EXP]		
	1790001250	S.DIO MA2S111-(TX) [ITR]		
	1790001250	S.DIO MA2S111-(TX) [UK]		
	1790001250	S.DIO MA2S111-(TX) [KOR]		
	1790001250	S.DIO MA2S111-(TX) [AUS]		
	1790001250	S.DIO MA2S111-(TX) [CHN]		
D2158	1790001250	S.DIO MA2S111-(TX)	T	48.5/88.4
D2159	1790001250	S.DIO MA2S111-(TX)	T	48.5/89.7
D2160	1790001250	S.DIO MA2S111-(TX)	T	48.5/91
D2162	1790001250	S.DIO MA2S111-(TX) [USA] only	T	46/88.4
D2163	1790001250	S.DIO MA2S111-(TX) [EUR]	T	46/89.7
	1790001250	S.DIO MA2S111-(TX) [FRA]		
	1790001250	S.DIO MA2S111-(TX) [ESP]		
	1790001250	S.DIO MA2S111-(TX) [ITR]		
	1790001250	S.DIO MA2S111-(TX) [UK]		
D2166	1790001250	S.DIO MA2S111-(TX) [ESP]	T	29.4/88.2
	1790001250	S.DIO MA2S111-(TX) [ITR]		
	1790001250	S.DIO MA2S111-(TX) [KOR]		
D2168	1790001250	S.DIO MA2S111-(TX) [EUR]	T	29.4/90.6
	1790001250	S.DIO MA2S111-(TX) [ESP]		
	1790001250	S.DIO MA2S111-(TX) [ITR]		
	1790001250	S.DIO MA2S111-(TX) [UK]		
	1790001250	S.DIO MA2S111-(TX) [AUS]		
D2169	1790001250	S.DIO MA2S111-(TX) [EUR]	T	26.9/87.1
	1790001250	S.DIO MA2S111-(TX) [ESP]		
	1790001250	S.DIO MA2S111-(TX) [USA]		
	1790001250	S.DIO MA2S111-(TX) [EXP]		
	1790001250	S.DIO MA2S111-(TX) [ITR]		
	1790001250	S.DIO MA2S111-(TX) [UK]		
	1790001250	S.DIO MA2S111-(TX) [KOR]		
D2170	1790001250	S.DIO MA2S111-(TX) [CHN]	T	26.9/88.4
	1790001250	S.DIO MA2S111-(TX) [EUR]		
	1790001250	S.DIO MA2S111-(TX) [USA]		
	1790001250	S.DIO MA2S111-(TX) [EXP]		
	1790001250	S.DIO MA2S111-(TX) [UK]		
	1790001250	S.DIO MA2S111-(TX) [AUS]		
	1790001250	S.DIO MA2S111-(TX) [CHN]		
D2171	1790001250	S.DIO MA2S111-(TX) [FRA]	T	26.9/89.7
	1790001250	S.DIO MA2S111-(TX) [ESP]		
	1790001250	S.DIO MA2S111-(TX) [EXP]		
	1790001250	S.DIO MA2S111-(TX) [UK]		
	1790001250	S.DIO MA2S111-(TX) [KOR]		
	1790001250	S.DIO MA2S111-(TX) [CHN]		
D2172	1790001250	S.DIO MA2S111-(TX)	T	26.9/91
D2173	1790001250	S.DIO MA2S111-(TX)	T	6.4/120.2
D2174	1790001250	S.DIO MA2S111-(TX)	T	52/88.2
D2175	1790001250	S.DIO MA2S111-(TX)	T	52/87
D2201	1730002340	S.ZEN MA8047-M(TX)	T	10.5/122.8
D2205	1790001010	S.ZEN MA8043-L(TX)	T	13.5/115.2
D2211	1790001010	S.ZEN MA8043-L(TX)	T	21.5/118
D2231	1160000070	S.DIO DAN202K T146	T	57.6/117.8
D2232	1790001670	S.DIO RB706F-40T106	T	56.8/112.2
D2401	1160000070	S.DIO DAN202K T146	B	85.7/27.2
D2402	1790001250	S.DIO MA2S111-(TX)	T	63.5/113.2
D2551	1790001140	S.ZEN MA8039-L(TX)	B	45.3/116.5
D2601	1160000070	S.DIO DAN202K T146	B	42/126.3
D2602	1790001250	S.DIO MA2S111-(TX)	B	41.2/128.5
FI2	2040001420	S.LC LFB32440MSC1-955 (LFSC25N12B0)	T	59.3/13.9
FI3	2040001420	S.LC LFB32440MSC1-955 (LFSC25N12B0)	T	53.3/13.4
FI601	2010002640	S.XTA DSF753SDF 124.487 MHz(FL-374)	T	
81/43.7				
FI901	2020002011	S.CER CFUKG455KF4A-R0	T	44.7/69.7
FI1001	2020002011	S.CER CFUKG455KF4A-R0	T	27.8/66.9

[MAIN UNIT]

REF NO.	PARTS NO.	DESCRIPTION	M.	H/V LOCATION
FI1401	2020001810	S.CER SFECV10M7FA00-R0 (SFECV10.7MA5S)	B	37.5/76.4
FI1402	2020001810	S.CER SFECV10M7FA00-R0 (SFECV10.7MA5S)	B	29.5/77.5
FI1501	2040001561	SAW TSB6321DL [EUR]		
	2040001561	SAW TSB6321DL [FRA]		
	2040001561	SAW TSB6321DL [ESP]		
	2040001571	SAW TSB6221DL [USA]		
	2040001561	SAW TSB6321DL [EXP]		
	2040001561	SAW TSB6321DL [ITR]		
	2040001561	SAW TSB6321DL [UK]		
	2040001571	SAW TSB6221DL [KOR]		
	2040001561	SAW TSB6321DL [AUS]		
	2040001561	SAW TSB6321DL [CHN]		
FI1502	2020001720	S.CER SFSKA5M50CF00-R1 (SFSCC5.5MC2-T) [EUR]	B	69.3/57.8
	2020001720	S.CER SFSKA5M50CF00-R1 (SFSCC5.5MC2-T) [FRA]		
	2020001720	S.CER SFSKA5M50CF00-R1 (SFSCC5.5MC2-T) [ESP]		
	2020001700	S.CER SFSKA4M50CF00-R1 (SFSCC4.5MC2-T) [USA]		
	2020001720	S.CER SFSKA5M50CF00-R1 (SFSCC5.5MC2-T) [EXP]		
	2020001720	S.CER SFSKA5M50CF00-R1 (SFSCC5.5MC2-T) [ITR]		
	2020001720	S.CER SFSKA5M50CF00-R1 (SFSCC5.5MC2-T) [UK]		
	2020001700	S.CER SFSKA4M50CF00-R1 (SFSCC4.5MC2-T) [KOR]		
	2020001720	S.CER SFSKA5M50CF00-R1 (SFSCC5.5MC2-T) [AUS]		
	2020001720	S.CER SFSKA5M50CF00-R1 (SFSCC5.5MC2-T) [CHN]		
FI1503	2020001730	S.CER TPSKA5M50B00-R1 (TPSCC5.5MB-TC1) [EUR]	B	73.5/78.7
	2020001730	S.CER TPSKA5M50B00-R1 (TPSCC5.5MB-TC1) [FRA]		
	2020001730	S.CER TPSKA5M50B00-R1 (TPSCC5.5MB-TC1) [ESP]		
	2020001710	S.CER TPSKA4M50B00-R1 (TPSCC4.5M0-TC1) [USA]		
	2020001730	S.CER TPSKA5M50B00-R1 (TPSCC5.5MB-TC1) [EXP]		
	2020001730	S.CER TPSKA5M50B00-R1 (TPSCC5.5MB-TC1) [ITR]		
	2020001730	S.CER TPSKA5M50B00-R1 (TPSCC5.5MB-TC1) [UK]		
	2020001710	S.CER TPSKA4M50B00-R1 (TPSCC4.5M0-TC1) [KOR]		
	2020001730	S.CER TPSKA5M50B00-R1 (TPSCC5.5MB-TC1) [AUS]		
	2020001730	S.CER TPSKA5M50B00-R1 (TPSCC5.5MB-TC1) [CHN]		
L3	6200004480	S.COI MLF1608D R82K-T	T	76.4/10.1
L4	6200002041	S.COI NLV25T-101J	T	75.6/18.9
L5	6200004780	S.COI MLF1608A 1R5K-T	T	67.4/18.6
L7	6200011320	S.COI ELJQE 56NJ [AUS] only		
L8	6200010910	S.COI LQW18AN56NG00D	T	57/16.6
L10	6200010910	S.COI LQW18AN56NG00D	T	57.3/17.9
L11	6200011780	S.COI LQW18ANR18G00D	T	56.5/20
L12	6200011680	S.COI LQW18ANR12G00D	T	53.8/19.8
L13	6200011780	S.COI LQW18ANR18G00D	T	52.8/18.5
L14	6200009590	S.COI MLG1608B 18NJ-T	T	57.3/11.4
L16	6200005721	S.COI ELJRE 33NGFA [EUR]	T	49.6/19.8
	6200005721	S.COI ELJRE 33NGFA [FRA]		
	6200005721	S.COI ELJRE 33NGFA [ESP]		
	6200005721	S.COI ELJRE 33NGFA [USA]		
	6200005721	S.COI ELJRE 33NGFA [EXP]		
	6200005721	S.COI ELJRE 33NGFA [ITR]		
	6200006991	S.COI ELJRE 56NGFA [UK]		
	6200005721	S.COI ELJRE 33NGFA [KOR]		
	6200005721	S.COI ELJRE 33NGFA [AUS]		
	6200005721	S.COI ELJRE 33NGFA [CHN]		
L18	6200005041	S.COI NLV25T-220J	T	73.4/9.5
L19	6200002041	S.COI NLV25T-101J	T	66.9/14.8
L21	6200006671	S.COI ELJRE 68NGFA	B	80.4/14.6
L22	6200002861	S.COI NLV25T-4R7J	B	79.7/20.2
L23	6200002861	S.COI NLV25T-4R7J	B	84/9.2
L24	6200011520	S.COI SLF7045T-102MR14-PF	B	8.8/69
L101	6200002041	S.COI NLV25T-101J	T	15.7/17
L102	6200002041	S.COI NLV25T-101J	T	20.4/10.9
L103	6200010800	S.COI C2520C-4R7G-A	T	24.4/7.4
L104	6200010800	S.COI C2520C-4R7G-A	T	27.9/10
L105	6200002041	S.COI NLV25T-101J	T	28.1/12.8
L106	6200002041	S.COI NLV25T-101J	B	17.5/16.3
L107	6200002041	S.COI NLV25T-101J	B	31.6/21.6
L108	6200002041	S.COI NLV25T-101J	T	25.2/20.8
L109	6200001831	S.COI NLV32T-100J	T	28.5/15.6
L110	6200003121	S.COI NLV32T-8R2J	T	21.1/15.1
L112	6200002041	S.COI NLV25T-101J	B	43.5/23
L113	6200002041	S.COI NLV25T-101J	T	7.2/17.6
L114	6200002041	S.COI NLV25T-101J	T	7.2/15
L116	6200003131	S.COI NLV32T-120J	T	28.5/18.6

M.=Mounted side (T: Mounted on the Top side, B: Mounted on the Bottom side) S.=Surface mount

[MAIN UNIT]

REF NO.	PARTS NO.	DESCRIPTION	M.	H/V LOCATION
L117	6200001831	S.COI NLV32T-100J	T	21.1/18.1
L204	6200002041	S.COI NLV25T-101J	T	18.7/32.9
L205	6200010740	S.COI C2520C-R27G-A	T	20.2/38.1
L207	6200010680	S.COI C2520C-R22G-A (0.22U)	T	21.8/41.3
L213	6200005011	S.COI NLV25T-100J	T	22.7/34.9
L215	6200010330	S.COI C2012C-R18G-A	B	27.7/38.6
L217	6200009990	S.COI C2012C-R22G-A	T	22.7/32.5
L218	6200005011	S.COI NLV25T-100J	B	25.6/43.3
L219	6200011050	S.COI C2012C-R12G-A	B	29/41.4
L220	6200010320	S.COI C2012C-R15G-A	B	34.1/37.9
L221	6200002041	S.COI NLV25T-101J	T	15.1/52.6
L222	6200002041	S.COI NLV25T-101J	T	45.6/61.4
L223	6200002041	S.COI NLV25T-101J	B	40.4/55.3
L224	6200002041	S.COI NLV25T-101J	B	27.5/55.7
L225	6200002041	S.COI NLV25T-101J	B	27.4/52
L226	6200002861	S.COI NLV25T-4R7J	T	40.3/57.6
L227	6200003711	S.COI NLV25T-2R7J	T	29.1/55.5
L228	6200002861	S.COI NLV25T-4R7J	T	44.6/54.7
L229	6200004671	S.COI NLV25T-3R9J	T	35.1/51.5
L230	6200002041	S.COI NLV25T-101J	B	40.4/52.2
L231	6200002041	S.COI NLV25T-101J	B	40.4/49.4
L232	6200002041	S.COI NLV25T-101J	B	27.1/49.1
L233	6200002041	S.COI NLV25T-101J	B	26.4/46.2
L234	6200010780	S.COI C2520C-1R0G-A	T	35.5/48.5
L235	6200010530	S.COI C2520C-R56G-A (0.56U)	B	32.9/49.5
L236	6200010950	S.COI C2520C-1R5G-A (1.5U)	T	43.4/50.4
L237	6200010450	S.COI C2520C-R82G-A (0.82U)	B	32.9/46.3
L238	6200002041	S.COI NLV25T-101J	B	43.9/45
L239	6200002041	S.COI NLV25T-101J	B	38.8/39.5
L240	6200002041	S.COI NLV25T-101J	T	29.5/42.1
L241	6200010870	S.COI C2520C-R33G-A (0.33U)	B	35.1/41.6
L242	6200005011	S.COI NLV25T-100J	T	33.5/29.9
L243	6140004601	S.COI LR-518A	T	28.4/35.2
L244	6200010960	S.COI C2520C-R47G-A (0.47U)	B	39.7/44.1
L245	6200005011	S.COI NLV25T-100J	B	41.2/28.3
L246	6200009990	S.COI C2012C-R22G-A	B	30.7/36.4
L247	6200010320	S.COI C2012C-R15G-A	B	42.1/38.7
L248	6200005011	S.COI NLV25T-100J	B	43.8/36.3
L301	6200002041	S.COI NLV25T-101J	T	36.1/27.4
L302	6200002041	S.COI NLV25T-101J	T	52.6/31.8
L303	6200002041	S.COI NLV25T-101J	T	52.3/35.4
L304	6140004591	S.COI LR-517A	T	56.4/39
L305	6200002041	S.COI NLV25T-101J	T	52.8/29.3
L306	6200002041	S.COI NLV25T-101J	T	61.7/39.3
L307	6200002041	S.COI NLV25T-101J	T	60.9/32
L308	6200002041	S.COI NLV25T-101J	T	64.9/33.1
L309	6200009070	S.COI LQW18AN18NG00D (LQW1608A18NG00)	T	49.3/24
L310	6200010650	S.COI C2520C-R12G-A (0.12U)	T	65.7/38.2
L311	6200009220	S.COI LQW18AN15NG00D (LQW1608A15NG00)	T	53.5/23.2
L312	6200010660	S.COI C2520C-R15G-A (0.15U)	T	69.6/34.3
L313	6200011730	S.COI LQW18AN10NG00D	T	61.5/25.7
L314	6200002041	S.COI NLV25T-101J	T	72.5/37.3
L315	6200002041	S.COI NLV25T-101J	T	75.8/31.9
L402	6140004610	S.COI LR-520	T	70.8/27.9
L403	6200002041	S.COI NLV25T-101J	T	81.1/19.7
L404	6130002961	S.COI #617DB-1327=P3	T	84.4/27.9
L406	6130002961	S.COI #617DB-1327=P3	T	77.6/24.2
L421	6200004590	S.COI MLF1608D R18K-T	T	86.4/21.7
L501	6200004660	S.COI MLF1608A 1R8K-T	T	93.4/35.7
L503	6200004660	S.COI MLF1608A 1R8K-T	T	83.2/31.1
L507	6200001981	S.COI NLV25T-1R0J	T	78.7/34.4
L508	6200010650	S.COI C2520C-R12G-A (0.12U)	T	86.3/34.4
L509	6200004660	S.COI MLF1608A 1R8K-T	T	93.1/38.7
L511	6200004150	S.COI MLF1608D 47NM-T	T	92.7/37.2
L512	6200009610	S.COI MLG1608B 39NJ-T	B	89.6/32.8
L601	6200004660	S.COI MLF1608A 1R8K-T	B	85.7/38.6
L603	6200004660	S.COI MLF1608A 1R8K-T	T	89.3/42.2
L604	6150005330	S.COI LS-548PKI-4185	T	90.5/46.2
L605	6200004660	S.COI MLF1608A 1R8K-T	T	93.1/39.9
L607	6200011800	S.COI C2520C-47NG-A	B	85.6/43.5
L609	6200011800	S.COI C2520C-47NG-A	B	81.5/46
L610	6200004660	S.COI MLF1608A 1R8K-T	B	78.1/44.8
L611	6200004660	S.COI MLF1608A 1R8K-T	T	68/46.3
L612	6150005330	S.COI LS-548PKI-4185	T	72.2/42.4
L701	6150005350	S.COI LS-550PKI-4187	T	62.9/48.6
L702	6150005340	S.COI LS-549PKI-4186	T	54.8/45.4
L703	6150005350	S.COI LS-550PKI-4187	T	55.3/59.5
L704	6200004940	S.COI MLF1608D R27K-T	T	62.3/59.6
L705	6200009920	S.COI C2012C-R10G-A	T	61.8/41.7
L801	6140002810	S.COI LR-317	T	68.6/61.3
L802	6200005190	S.COI MLF1608D R56K-T	T	89/58.4
L803	6140002810	S.COI LR-317	T	79.6/60.1
L804	6200005011	S.COI NLV25T-100J	T	57.5/69.1
L805	6200009871	S.COI NLV25T-120J	T	57.6/71.9
L806	6200004741	S.COI NLV25T-1R2J	T	63.1/71.2
L807	6200004741	S.COI NLV25T-1R2J	T	63.2/66.7
L808	6200004100	S.COI MLF1608D 68NM-T	T	86.1/61.6
L901	6200003520	S.COI ELJFB 102K-F	B	37.6/72.4
L904	6150005360	S.COI LS-551PKI-4188-1	T	51.6/70.9
L905	6200003520	S.COI ELJFB 102K-F	B	40.2/59.9
L906	6200003520	S.COI ELJFB 102K-F	B	33.6/62.4
L908	6200003520	S.COI ELJFB 102K-F	B	31.5/69.7
L1003	6200003520	S.COI ELJFB 102K-F	B	12.9/75.3
L1102	6200002041	S.COI NLV25T-101J	T	7.1/89.7
L1301	6200002041	S.COI NLV25T-101J	T	8.3/55.8

[MAIN UNIT]

REF NO.	PARTS NO.	DESCRIPTION	M.	H/V LOCATION
L1302	6200002041	S.COI NLV25T-101J	T	11.8/58.5
L1303	6200002041	S.COI NLV25T-101J	T	4.8/55.8
L1401	6200002041	S.COI NLV25T-101J	B	43.3/79.6
L1402	6200004790	S.COI MLF1608D R47K-T	B	44.1/70.4
L1403	6200002041	S.COI NLV25T-101J	B	43/77.1
L1404	6200003711	S.COI NLV25T-2R7J	B	18.2/80.4
L1405	6200002041	S.COI NLV25T-101J	B	17.7/85
L1491	6200010870	S.COI C2520C-R33G-A (0.33U) [EUR]	B	84.9/30.7
	6200010870	S.COI C2520C-R33G-A (0.33U) [FRA]		
	6200010870	S.COI C2520C-R33G-A (0.33U) [ESP]		
	6200010740	S.COI C2520C-R27G-A [USA]		
	6200010870	S.COI C2520C-R33G-A (0.33U) [EXP]		
	6200010870	S.COI C2520C-R33G-A (0.33U) [ITR]		
	6200010870	S.COI C2520C-R33G-A (0.33U) [UK]		
	6200010740	S.COI C2520C-R27G-A [KOR]		
	6200010870	S.COI C2520C-R33G-A (0.33U) [AUS]		
	6200010870	S.COI C2520C-R33G-A (0.33U) [CHN]		
L1492	6200010870	S.COI C2520C-R33G-A (0.33U) [EUR]	B	80.6/33.1
	6200010870	S.COI C2520C-R33G-A (0.33U) [FRA]		
	6200010870	S.COI C2520C-R33G-A (0.33U) [ESP]		
	6200010740	S.COI C2520C-R27G-A [USA]		
	6200010870	S.COI C2520C-R33G-A (0.33U) [EXP]		
	6200010870	S.COI C2520C-R33G-A (0.33U) [ITR]		
	6200010870	S.COI C2520C-R33G-A (0.33U) [UK]		
	6200010740	S.COI C2520C-R27G-A [KOR]		
	6200010870	S.COI C2520C-R33G-A (0.33U) [AUS]		
	6200010870	S.COI C2520C-R33G-A (0.33U) [CHN]		
L1501	6200005011	S.COI NLV25T-100J	B	91.1/27.1
L1502	6200012170	S.COI MLG1608SR18J-T	B	79.4/38.2
L1503	6200012170	S.COI MLG1608SR18J-T	B	82/37.5
L1504	6200005011	S.COI NLV25T-100J	B	75.6/43.4
L1505	6200005190	S.COI MLF1608D R56K-T	B	73.2/48.5
L1506	6200005080	S.COI LS-535 (4KMH) [EUR]	T	68.7/55.4
	6150005080	S.COI LS-535 (4KMH) [FRA]		
	6150005080	S.COI LS-535 (4KMH) [ESP]		
	6150005070	S.COI LS-534 (4KMH) [USA]		
	6150005080	S.COI LS-535 (4KMH) [EXP]		
	6150005080	S.COI LS-535 (4KMH) [ITR]		
	6150005080	S.COI LS-535 (4KMH) [UK]		
	6150005070	S.COI LS-534 (4KMH) [KOR]		
	6150005080	S.COI LS-535 (4KMH) [AUS]		
	6150005080	S.COI LS-535 (4KMH) [CHN]		
L1507	6200005031	S.COI NLV25T-180J	B	71.7/62.2
L1508	6200005021	S.COI NLV25T-150J	B	77.3/79.5
L1951	6180003610	S.COI 7E10L-101M 100U	B	34.6/110.9
L1952	6180003610	S.COI 7E10L-101M 100U	B	54.7/113.3
L1953	6180003610	S.COI 7E10L-101M 100U	B	14/111.9
L1954	6180003610	S.COI 7E10L-101M 100U	B	24.4/119.8
L2001	6200005011	S.COI NLV25T-100J	B	72.5/16.4
L2002	6200002041	S.COI NLV25T-101J	B	84.5/3.8
L2003	6200002041	S.COI NLV25T-101J	B	81.1/4.3
L2004	6200002041	S.COI NLV25T-101J	B	76.3/20.4
L2006	6200002041	S.COI NLV25T-101J	B	64.2/12.8
L2007	6200002041	S.COI NLV25T-101J	B	70.9/3.8
L2008	6200002041	S.COI NLV25T-101J	B	67.9/6.1
L2009	6200005011	S.COI NLV25T-100J	B	70.8/10.6
L2010	6200002041	S.COI NLV25T-101J	B	60.7/13.7
L2011	6200011300	S.COI EXCML16A270U	T	86.6/9.1
L2012	6200011300	S.COI EXCML16A270U	B	84.7/21.9
L2013	6200002041	S.COI NLV25T-101J	B	71.8/19.4
L2015	6200002041	S.COI NLV25T-101J	B	52.5/10.4
L2016	6200002041	S.COI NLV25T-101J	B	59.2/11.2
L2017	6200002041	S.COI NLV25T-101J	B	57/14
L2018	6200002041	S.COI NLV25T-101J	B	19.7/129.4
L2019	6200002041	S.COI NLV25T-101J	T	22.2/126.9
L2020	6200002041	S.COI NLV25T-101J	B	27.9/131.3
L2021	6200005011	S.COI NLV25T-100J	B	27.9/126.5
L2022	6200002041	S.COI NLV25T-101J	B	22.6/127.6
L2023	6200002041	S.COI NLV25T-101J	B	23.2/131.3
L2024	6200002041	S.COI NLV25T-101J	T	12.7/128.2
L2025	6200002041	S.COI NLV25T-101J	B	87.5/6.5
L2026	6200002041	S.COI NLV25T-101J	B	77.6/5
L2027	6200002041	S.COI NLV25T-101J	B	76.5/12.2
L2028	6200002041	S.COI NLV25T-101J	B	67.4/10.8
L2029	6200002041	S.COI NLV25T-101J	B	64/10.3
L2030	6200002041	S.COI NLV25T-101J	B	67.5/3.6
L2031	6200002041	S.COI NLV25T-101J	B	76.5/14.7
L2032	6200002041	S.COI NLV25T-101J	B	66.1/15.3
L2033	6200011300	S.COI EXCML16A270U	B	69.6/14.5
L2034	6200009300	S.COI ELJPA 100KF 10U	B	67.8/19.3
L2035	6200002041	S.COI NLV25T-101J	B	59.8/18.4
L2036	6200002041	S.COI NLV25T-101J	B	64.1/3.8
L2037	6200002041	S.COI NLV25T-101J	B	88.3/3.7
L2041	6180003610	S.COI 7E10L-101M 100U	B	62.6/86.9
L2042	6200002861	S.COI NLV25T-4R7J	B	62.9/79.3
L2053	6200002041	S.COI NLV25T-101J	B	28.7/90.9
L2151	6200002041	S.COI NLV25T-101J	B	36.9/121
L2152	6200002041	S.COI NLV25T-101J	B	52.3/14.7
L2201	6200005011	S.COI NLV25T-100J	T	27.3/125.8
L2202	6200005011	S.COI NLV25T-100J	T	17/124.3
L2231	6200002041	S.COI NLV25T-101J	T	34/104.2
L2256	6200002041	S.COI NLV25T-101J	T	15/103.4
L2257	6200002041	S.COI NLV25T-101J	T	10.5/89.7
L2260	6200002041	S.COI NLV25T-10		

[MAIN UNIT]

REF NO.	PARTS NO.	DESCRIPTION	M.	H/V LOCATION
L2266	6200002041	S.COI NLV25T-101J	T	62.4/91.5
L2267	6200002041	S.COI NLV25T-101J	T	66/89.6
L2268	6200002041	S.COI NLV25T-101J	T	62.4/87.1
L2272	6200002041	S.COI NLV25T-101J	T	71.1/90.2
L2402	6200002041	S.COI NLV25T-101J	B	89.4/98
L2403	6200002041	S.COI NLV25T-101J	B	89.2/84
L2404	6200002041	S.COI NLV25T-101J	T	81.6/96.8
L2405	6200002041	S.COI NLV25T-101J	B	89.3/95.5
L2406	6200002041	S.COI NLV25T-101J	T	84.8/93.7
L2408	6200011300	S.COI EXCML16A270U	T	82.1/92.3
L2409	6200002041	S.COI NLV25T-101J	B	89.3/88.5
L2411	6200011300	S.COI EXCML16A270U	T	85.1/89.7
L2601	6200009330	S.COI SLF12555T-681MR43-PF	T	87.5/119.6
L2605	6200009330	S.COI SLF12555T-681MR43-PF	T	71/119.6
R1	7030011400	S.RES ERJ2GEJ 5R6 X (5.6)	T	79.7/17
R2	7030009270	S.RES ERJ2GEJ 821 X (820)	T	81.3/17
R3	7030009270	S.RES ERJ2GEJ 821 X (820)	T	79.7/17.9
R5	7030010090	S.RES ERJ2GEJ 180 X (18)	T	74.2/16.7
R6	7030008280	S.RES ERJ2GEJ 271 X (270)	T	74.8/15.8
R7	7030008280	S.RES ERJ2GEJ 271 X (270)	T	73.2/15.8
R8	7030009200	S.RES ERJ2GEJ 390 X (39)	T	73/18.5
R9	7030003400	S.RES ERJ3GEJ 471 V (470)	T	69.9/13.3
R10	7030005120	S.RES ERJ2GEJ 102 X (1K)	T	72.8/14.9
R11	7030005300	S.RES ERJ2GEJ 150 X (15)	T	62.1/15.9
R12	7030010040	S.RES ERJ2GEJ-JPW	T	62.9/13.8
R13	7030005090	S.RES ERJ2GEJ 104 X (100K)	T	66.8/20.6
R15	7030005090	S.RES ERJ2GEJ 104 X (100K)	T	70.4/10.4
R16	7030003860	S.RES ERJ3GE JPW V	T	62.4/12.3
R17	7030005090	S.RES ERJ2GEJ 104 X (100K)	T	76.4/15.8
R18	7030007270	S.RES ERJ2GEJ 151 X (150)	T	44.2/17.2
R19	7030003860	S.RES ERJ3GE JPW V	T	50.4/14.6
R20	7030009530	S.RES ERJ2GEJ 270 X (27)	T	69.5/19.7
R21	7030009530	S.RES ERJ2GEJ 270 X (27)	T	65.4/22.8
R22	7030010040	S.RES ERJ2GEJ-JPW	T	78.1/13.8
R23	7030007290	S.RES ERJ2GEJ 222 X (2.2K)	T	79.8/13.8
R24	7030005010	S.RES ERJ2GEJ 671 X (680)	T	78.1/12.9
R25	7030005120	S.RES ERJ2GEJ 102 X (1K)	B	79.2/18.5
R27	7030005120	S.RES ERJ2GEJ 102 X (1K)	B	81.3/8.5
R29	7030004980	S.RES ERJ2GEJ 101 X (100)	T	73.1/11.3
R30	7030009160	S.RES ERJ2GEJ 181 X (180)	T	46.4/15.4
R31	7030007270	S.RES ERJ2GEJ 151 X (150)	T	42.6/17.2
R32	7030009200	S.RES ERJ2GEJ 390 X (39)	T	44.1/18.2
R35	7030003860	S.RES ERJ3GE JPW V [EUR]	T	59.9/17.8
	7030003860	S.RES ERJ3GE JPW V [FRA]		
	7030003860	S.RES ERJ3GE JPW V [ESP]		
	7030003860	S.RES ERJ3GE JPW V [USA]		
	7030003860	S.RES ERJ3GE JPW V [EXP]		
	7030003860	S.RES ERJ3GE JPW V [ITR]		
	7030003860	S.RES ERJ3GE JPW V [UK]		
	7030003860	S.RES ERJ3GE JPW V [KOR]		
	7030003860	S.RES ERJ3GE JPW V [CHN]		
R101	7030005050	S.RES ERJ2GEJ 103 X (10K)	T	13.2/16
R102	7030005120	S.RES ERJ2GEJ 102 X (1K)	T	11.9/14.6
R103	7030005050	S.RES ERJ2GEJ 103 X (10K)	T	10.3/14.6
R104	7030005090	S.RES ERJ2GEJ 104 X (100K)	T	15.7/13.4
R105	7030005580	S.RES ERJ2GEJ 560 X (56)	T	15.7/22.3
R106	7030005000	S.RES ERJ2GEJ 471 X (470)	T	13.2/20.5
R107	7030005000	S.RES ERJ2GEJ 471 X (470)	T	10.8/22.1
R108	7030005000	S.RES ERJ2GEJ 471 X (470)	T	10.8/23
R111	7030005000	S.RES ERJ2GEJ 471 X (470)	T	10.8/21.2
R112	7030005090	S.RES ERJ2GEJ 104 X (100K)	T	25.6/12.5
R113	7030005090	S.RES ERJ2GEJ 104 X (100K)	T	26.8/5.7
R114	7030009280	S.RES ERJ2GEJ 391 X	B	33.1/23.4
R115	7030009280	S.RES ERJ2GEJ 391 X	B	34.1/22.2
R116	7030009280	S.RES ERJ2GEJ 391 X	T	22.3/21.3
R117	7030009280	S.RES ERJ2GEJ 391 X	T	20.7/21.3
R118	7030009280	S.RES ERJ2GEJ 391 X	B	40.9/23.2
R119	7030009280	S.RES ERJ2GEJ 391 X	B	40.9/22.3
R120	7030005090	S.RES ERJ2GEJ 104 X (100K)	B	50.3/23.5
R121	7030005090	S.RES ERJ2GEJ 104 X (100K)	T	44/22.2
R122	7030009280	S.RES ERJ2GEJ 391 X	T	7.8/20.3
R123	7030009280	S.RES ERJ2GEJ 391 X	T	7.8/19.4
R125	7030009280	S.RES ERJ2GEJ 391 X	T	35.5/20.2
R126	7030009280	S.RES ERJ2GEJ 391 X	T	27/4.8
R127	7030009280	S.RES ERJ2GEJ 391 X	T	25.4/4.8
R128	7030009280	S.RES ERJ2GEJ 391 X	T	35.5/19.3
R202	7030005090	S.RES ERJ2GEJ 104 X (100K)	T	18.1/31.2
R203	7030005090	S.RES ERJ2GEJ 104 X (100K)	T	42.9/59.9
R204	7030005090	S.RES ERJ2GEJ 104 X (100K)	B	42.9/54.3
R205	7030009280	S.RES ERJ2GEJ 391 X	T	19.4/54.2
R206	7030005090	S.RES ERJ2GEJ 104 X (100K)	B	42.9/51.4
R207	7030005090	S.RES ERJ2GEJ 104 X (100K)	B	42.9/50.5
R208	7030005090	S.RES ERJ2GEJ 104 X (100K)	B	46.4/45
R216	7030005090	S.RES ERJ2GEJ 104 X (100K)	B	44.2/43.3
R217	7030005050	S.RES ERJ2GEJ 103 X (10K)	T	18.1/30.3
R218	7030004970	S.RES ERJ2GEJ 470 X (47)	T	21.9/29.9
R225	7030005050	S.RES ERJ2GEJ 103 X (10K)	T	19.1/29.1
R226	7030009280	S.RES ERJ2GEJ 391 X	T	17.6/54.2
R227	7030005120	S.RES ERJ2GEJ 102 X (1K)	T	30.9/30.9
R228	7030009140	S.RES ERJ2GEJ 272 X (2.7K)	T	30.9/29.1
R301	7030009280	S.RES ERJ2GEJ 391 X	T	44.5/28.8
R302	7030009280	S.RES ERJ2GEJ 391 X	T	38.6/27.8
R303	7030004970	S.RES ERJ2GEJ 470 X (47)	T	52.5/38.9
R304	7030004980	S.RES ERJ2GEJ 101 X (100)	T	55.1/35.6
R305	7030005120	S.RES ERJ2GEJ 102 X (1K)	T	59.9/33.8

[MAIN UNIT]

REF NO.	PARTS NO.	DESCRIPTION	M.	H/V LOCATION
R306	7030008280	S.RES ERJ2GEJ 271 X (270)	T	55.3/28.7
R307	7030004980	S.RES ERJ2GEJ 101 X (100)	T	56.7/35.6
R308	7030007290	S.RES ERJ2GEJ 222 X (2.2K)	T	59.2/30.1
R309	7030008280	S.RES ERJ2GEJ 271 X (270)	T	58.5/29.1
R310	7030005090	S.RES ERJ2GEJ 104 X (100K)	T	50.1/31.7
R311	7030009280	S.RES ERJ2GEJ 391 X	T	65.3/31.3
R312	7030009280	S.RES ERJ2GEJ 391 X	T	63.7/31.3
R314	7030009280	S.RES ERJ2GEJ 391 X	T	73.3/32.5
R315	7030009280	S.RES ERJ2GEJ 391 X	T	74.8/33.8
R401	7030010040	S.RES ERJ2GEJ-JPW	T	75/29.5
R402	7030010040	S.RES ERJ2GEJ-JPW	T	75/27.7
R403	7030004980	S.RES ERJ2GEJ 101 X (100)	T	76.7/29.6
R404	7030010040	S.RES ERJ2GEJ-JPW	T	71.9/23.1
R405	7030004980	S.RES ERJ2GEJ 101 X (100)	T	86.8/23.8
R406	7030005580	S.RES ERJ2GEJ 560 X (56)	T	73.1/30.6
R407	7030005580	S.RES ERJ2GEJ 560 X (56)	T	71.9/24.9
R408	7030010040	S.RES ERJ2GEJ-JPW	T	83.3/19.2
R411	7030007260	S.RES ERJ2GEJ 330 X (33)	T	80/29.5
R412	7030007260	S.RES ERJ2GEJ 330 X (33)	T	80/26.8
R414	7030004980	S.RES ERJ2GEJ 101 X (100)	T	78.3/29.6
R416	7030010090	S.RES ERJ2GEJ 180 X (18)	T	88.3/24.4
R417	7030008280	S.RES ERJ2GEJ 271 X (270)	T	89.2/25.3
R418	7030008280	S.RES ERJ2GEJ 271 X (270)	T	88/22.8
R421	7030010090	S.RES ERJ2GEJ 180 X (18)	B	88.5/20.2
R422	7030008280	S.RES ERJ2GEJ 271 X (270)	B	90.1/20.2
R423	7030008280	S.RES ERJ2GEJ 271 X (270)	B	90.1/19.3
R424	7030005530	S.RES ERJ2GEJ 100 X (10)	T	88.5/21.6
R501	7030005120	S.RES ERJ2GEJ 102 X (1K)	T	91.3/35.6
R502	7030005120	S.RES ERJ2GEJ 102 X (1K)	T	92.9/34.4
R509	7030005580	S.RES ERJ2GEJ 560 X (56)	T	83.4/33.8
R510	7030010040	S.RES ERJ2GEJ-JPW	T	83.4/34.1
R512	7030004980	S.RES ERJ2GEJ 101 X (100)	T	81.7/34.1
R517	7030010040	S.RES ERJ2GEJ-JPW	B	80/31
R518	7030007290	S.RES ERJ2GEJ 222 X (2.2K)	T	79.5/37
R519	7030007290	S.RES ERJ2GEJ 222 X (2.2K)	T	79.5/38.8
R520	7030005120	S.RES ERJ2GEJ 102 X (1K)	T	89.1/39.2
R521	7030005000	S.RES ERJ2GEJ 471 X (470)	T	84.2/40.4
R523	7030005120	S.RES ERJ2GEJ 102 X (1K)	T	91.3/34.7
R524	7030005120	S.RES ERJ2GEJ 102 X (1K)	B	86.9/37
R601	7030005000	S.RES ERJ2GEJ 471 X (470)	B	88.5/40
R602	7030005000	S.RES ERJ2GEJ 471 X (470)	T	91/39.6
R603	7030005000	S.RES ERJ2GEJ 471 X (470)	T	89.1/41
R604	7030005000	S.RES ERJ2GEJ 471 X (470)	B	78.6/45.9
R605	7030010040	S.RES ERJ2GEJ-JPW	T	68.2/45.2
R606	7030005090	S.RES ERJ2GEJ 104 X (100K)	T	67.1/47.4
R607	7030005120	S.RES ERJ2GEJ 102 X (1K)	T	66.6/45.2
R701	7030005220	S.RES ERJ2GEJ 223 X (22K)	T	61.1/53
R702	7030005120	S.RES ERJ2GEJ 102 X (1K)	T	64.2/43.9
R703	7030004970	S.RES ERJ2GEJ 470 X (47)	T	50.8/44.1
R705	7030004990	S.RES ERJ2GEJ 221 X (220)	T	59/51.5
R706	7030009270	S.RES ERJ2GEJ 821 X (820)	T	64.5/55.9
R707	7030004980	S.RES ERJ2GEJ 101 X (100)	T	59.5/57
R708	7030007290	S.RES ERJ2GEJ 222 X (2.2K)	T	63.9/58.6
R709	7030005210	S.RES ERJ2GEJ 822 X (8.2K)	T	59.5/55.1
R710	7030005120	S.RES ERJ2GEJ 102 X (1K)	T	59.8/62.5
R711	7030009140	S.RES ERJ2GEJ 272 X (2.7K)	T	50.5/51.4
R712	7030005120	S.RES ERJ2GEJ 102 X (1K)	T	51.2/50.5
R713	7030005050	S.RES ERJ2GEJ 103 X (10K)	T	57.1/51.5
R715	7030004970	S.RES ERJ2GEJ 470 X (47)	T	52.1/54.1
R716	7030005710	S.RES ERJ2GEJ 121 X (120)	T	51.3/57.5
R717	7030007300	S.RES ERJ2GEJ 332 X (3.3K)	T	52.1/51.4
R718	7510001461	S.THE NTCG16 3NH 471JT	T	63.3/54
R801	7030008280	S.RES ERJ2GEJ 271 X (270)	T	86.8/55.2
R802	7030005120	S.RES ERJ2GEJ 102 X (1K)	T	65.3/60.9
R803	7030005120	S.RES ERJ2GEJ 102 X (1K)	T	71.9/64.9
R804	7030005530	S.RES ERJ2GEJ 100 X (10)	T	91.1/57.1
R805	7030010090	S.RES ERJ2GEJ 180 X (18)	T	84.7/54.3
R806	7030008280	S.RES ERJ2GEJ 271 X (270)	T	85.2/55.2
R807	7030005120	S.RES ERJ2GEJ 102 X (1K)	T	62.8/64.6
R808	7030004970	S.RES ERJ2GEJ 470 X (47)	T	62.3/69.4
R809	7030008280	S.RES ERJ2GEJ 271 X (270)	T	82.8/60.6
R810	7030010090	S.RES ERJ2GEJ 180 X (18)	T	84.4/60.6
R811	7030008280	S.RES ERJ2GEJ 271 X (270)	T	82.8/59.7
R904	7030003860	S.RES ERJ3GE JPW V	T	36.5/68.1
R905	7030004980	S.RES ERJ2GEJ 101 X (100)	T	39.2/64.8
R906	7030007290	S.RES ERJ2GEJ 222 X (2.2K)	T	39.2/66.5
R908	7030005000	S.RES ERJ2GEJ 471 X (470)	T	35.6/61.9
R909	7030008410	S.RES ERJ2GEJ 392 X (3.9K)	T	34.2/68.4
R912	7030005210	S.RES ERJ2GEJ 822 X (8.2K)	T	34.2/66.6
R913	7030007300	S.RES ERJ2GEJ 332 X (3.3K)	T	40.5/75
R914	7030009290	S.RES ERJ2GEJ 562 X (5.6K)	T	35.6/75.4
R915	7030007290	S.RES ERJ2GEJ 222 X (2.2K)	T	36.6/70.9
R916	7030005050	S.RES ERJ2GEJ 103 X (10K)	T	37.2/75.4
R917	7030004970	S.RES ERJ2GEJ 470 X (47)	T	34.2/69.3
R918	7030007290	S.RES ERJ2GEJ 222 X (2.2K)	B	31.4/72.1
R919	7030004980	S.RES ERJ2GEJ 101 X (100)	T	31.5/72.1
R1009	7030009290	S.RES ERJ2GEJ 562 X (5.6K)	T	25.8/72.9
R1018	7030007290	S.RES ERJ2GEJ 222 X (2.2K)	T	20.3/75
R1019	7030005050	S.RES ERJ2GEJ 103 X (10K)	T	20.3/76.9
R1020	7030005000	S.RES ERJ2GEJ 471 X (470)	T	12.7/77.6
R1022	7510001461	S.THE NTCG16 3NH 471JT	T	14.8/76.8
R1023	7030008370	S.RES ERJ2GEJ 561 X (560)	T	15

[MAIN UNIT]

REF NO.	PARTS NO.	DESCRIPTION	M.	H/V LOCATION
R1203	7030005240	S.RES ERJ2GEJ 473 X (47K)	T	25.6/78.5
R1204	7030005240	S.RES ERJ2GEJ 473 X (47K)	T	20.2/79.2
R1205	7030005000	S.RES ERJ2GEJ 471 X (470)	T	20.2/78.3
R1206	7030005090	S.RES ERJ2GEJ 104 X (100K)	T	21.8/79.2
R1207	7030005240	S.RES ERJ2GEJ 473 X (47K)	T	17.9/83.6
R1208	7030004980	S.RES ERJ2GEJ 101 X (100)	T	9.4/79.8
R1209	7030004980	S.RES ERJ2GEJ 101 X (100)	T	16.4/79.9
R1211	7030005120	S.RES ERJ2GEJ 102 X (1K)	T	12.7/79.4
R1212	7030005120	S.RES ERJ2GEJ 102 X (1K)	T	11.1/78.5
R1213	7030005120	S.RES ERJ2GEJ 102 X (1K)	T	11.1/79.4
R1215	7030007350	S.RES ERJ2GEJ 393 X (39K)	T	8.1/81.3
R1216	7030007290	S.RES ERJ2GEJ 222 X (2.2K)	T	9.5/83.4
R1217	7030007290	S.RES ERJ2GEJ 222 X (2.2K)	T	8/82.8
R1218	7030005050	S.RES ERJ2GEJ 103 X (10K)	T	7.5/78.5
R1219	7030005050	S.RES ERJ2GEJ 103 X (10K)	T	7.5/79.7
R1301	7030010040	S.RES ERJ2GEJ-JPW	T	15.2/74.8
R1302	7030005120	S.RES ERJ2GEJ 102 X (1K)	T	15.2/72.7
R1303	7030005120	S.RES ERJ2GEJ 102 X (1K)	T	12.7/74
R1304	7030005120	S.RES ERJ2GEJ 102 X (1K)	T	14.9/68.3
R1305	7030005120	S.RES ERJ2GEJ 102 X (1K)	T	16.2/63.8
R1306	7030005120	S.RES ERJ2GEJ 102 X (1K)	T	10.9/56.8
R1308	7030007300	S.RES ERJ2GEJ 332 X (3.3K)	T	12.9/67.3
R1309	7030005120	S.RES ERJ2GEJ 102 X (1K)	T	11.3/66.4
R1310	7510001451	S.THE NTCG16 4BH 472JT	T	12.2/68.4
R1401	7030005120	S.RES ERJ2GEJ 102 X (1K)	B	45.3/72.3
R1402	7030008010	S.RES ERJ2GEJ 123 X (12K)	B	43.6/72.3
R1403	7030007290	S.RES ERJ2GEJ 222 X (2.2K)	B	44.5/73.4
R1404	7030007280	S.RES ERJ2GEJ 331 X (330)	B	44.5/75.2
R1405	7030004970	S.RES ERJ2GEJ 470 X (47)	B	42/71.5
R1406	7030005290	S.RES ERJ2GEJ 682 X (6.8K)	B	38.7/79.9
R1407	7030005120	S.RES ERJ2GEJ 102 X (1K)	B	38.7/79
R1408	7030007280	S.RES ERJ2GEJ 331 X (330)	B	38.7/80.8
R1409	7030004970	S.RES ERJ2GEJ 470 X (47)	B	34.6/80
R1414	7030007340	S.RES ERJ2GEJ 153 X (15K)	B	20.2/76.4
R1416	7030008410	S.RES ERJ2GEJ 392 X (3.9K)	B	19.4/83
R1420	7030004990	S.RES ERJ2GEJ 221 X (220)	B	25/76.8
R1421	7030007270	S.RES ERJ2GEJ 151 X (150)	B	23.2/75.9
R1422	7030004990	S.RES ERJ2GEJ 221 X (220)	B	23.2/76.8
R1501	7030010040	S.RES ERJ2GEJ-JPW	B	72.4/38.2
R1502	7030005100	S.RES ERJ2GEJ 154 X (150K)	B	86.4/55.3
R1503	7030005100	S.RES ERJ2GEJ 154 X (150K)	B	85.7/54.1
R1504	7030004970	S.RES ERJ2GEJ 470 X (47)	B	72.4/40.3
R1505	7030007290	S.RES ERJ2GEJ 222 X (2.2K)	B	71.8/53.9
R1506	7030007350	S.RES ERJ2GEJ 393 X (39K)	B	85.7/52.3
R1507	7030007350	S.RES ERJ2GEJ 393 X (39K)	B	85.7/53.2
R1508	7030005220	S.RES ERJ2GEJ 223 X (22K)	B	74.2/61.6
R1509	7030006610	S.RES ERJ2GEJ 394 X (390K)	B	85.9/59
R1510	7030005050	S.RES ERJ2GEJ 103 X (10K)	[USA] [KOR] B	76.6/61.9
R1511	7030005590	S.RES ERJ2GEJ 680 X (68)	B	85.8/60.8
R1512	7030005120	S.RES ERJ2GEJ 102 X (1K)	B	71.5/73.7
R1513	7030007280	S.RES ERJ2GEJ 331 X (330)	B	73.1/73.7
R1514	7030007290	S.RES ERJ2GEJ 222 X (2.2K)	B	73.4/53
R1515	7030007290	S.RES ERJ2GEJ 222 X (2.2K)	B	71.8/53
R1516	7030004970	S.RES ERJ2GEJ 470 X (47)	B	82.5/35.3
R1521	7030005090	S.RES ERJ2GEJ 104 X (100K)	B	86.5/50.3
R1522	7030005240	S.RES ERJ2GEJ 473 X (47K)	B	86.7/46.8
R1523	7030005120	S.RES ERJ2GEJ 102 X (1K)	B	77.3/39.5
R1524	7030005120	S.RES ERJ2GEJ 102 X (1K)	B	81.9/40.3
R1525	7030007300	S.RES ERJ2GEJ 332 X (3.3K)	B	81.9/42.2
R1526	7030005120	S.RES ERJ2GEJ 102 X (1K)	B	83.5/40.5
R1602	7030005120	S.RES ERJ2GEJ 102 X (1K)	T	6.3/54
R1603	7030010040	S.RES ERJ2GEJ-JPW	T	13/49.6
R1604	7030007290	S.RES ERJ2GEJ 222 X (2.2K)	T	13/50.5
R1605	7030005090	S.RES ERJ2GEJ 104 X (100K)	T	8.8/46.9
R1606	7030005070	S.RES ERJ2GEJ 683 X (68K)	T	6.1/46.6
R1607	7030005070	S.RES ERJ2GEJ 683 X (68K)	T	5.1/42.1
R1608	7030005090	S.RES ERJ2GEJ 104 X (100K)	T	10.4/47.8
R1609	7030007320	S.RES ERJ2GEJ 225 X (2.2M)	T	10.4/46
R1610	7030005060	S.RES ERJ2GEJ 333 X (33K)	T	4.5/43.5
R1611	7030005230	S.RES ERJ2GEJ 334 X (330K)	T	8.8/47.8
R1612	7030005060	S.RES ERJ2GEJ 333 X (33K)	T	3.4/42.3
R1613	7030003860	S.RES ERJ3GE JPW V	T	6.7/48.7
R1614	7030007310	S.RES ERJ2GEJ 155 X (1.5M)	T	6.1/45.7
R1615	7030005040	S.RES ERJ2GEJ 472 X (4.7K)	T	4.2/35.4
R1616	7030005090	S.RES ERJ2GEJ 104 X (100K)	T	6.7/35.4
R1617	7030005720	S.RES ERJ2GEJ 563 X (56K)	T	3.4/38.2
R1618	7310005020	S.TRI RH03ADC14X (10K)	T	3.5/46.3
R1619	7030005080	S.RES ERJ2GEJ 823 X (82K)	[EUR] [FRA] [ESP] [USA] [EXP] [ITR] [UK] [KOR] [AUS] [CHN]	2.6/43.3
R1620	7030008290	S.RES ERJ2GEJ 183 X (18K)	T	3.4/37.3
R1621	7030005160	S.RES ERJ2GEJ 105 X (1M)	T	6.7/37.2
R1622	7030010040	S.RES ERJ2GEJ-JPW	T	5/37.3
R1623	7030005000	S.RES ERJ2GEJ 471 X (470)	T	12/46.8
R1624	7030007250	S.RES ERJ2GEJ 220 X (22)	T	14.9/38.3
R1625	7030004990	S.RES ERJ2GEJ 221 X (220)	T	13.6/32.6
R1626	7030005050	S.RES ERJ2GEJ 103 X (10K)	T	10.3/34.5
R1627	7030007320	S.RES ERJ2GEJ 225 X (2.2M)	T	10.3/35.4
R1628	7030005120	S.RES ERJ2GEJ 102 X (1K)	T	4.9/30.8

[MAIN UNIT]

REF NO.	PARTS NO.	DESCRIPTION	M.	H/V LOCATION
R1629	7030005050	S.RES ERJ2GEJ 103 X (10K)	T	4.9/29.9
R1630	7030004980	S.RES ERJ2GEJ 101 X (100)	T	8.3/45.7
R1631	7030005090	S.RES ERJ2GEJ 104 X (100K)	T	9.8/37.2
R1634	7030005040	S.RES ERJ2GEJ 472 X (4.7K)	T	10.3/33.6
R1636	7030007320	S.RES ERJ2GEJ 225 X (2.2M)	T	13/31.7
R1637	7030007320	S.RES ERJ2GEJ 225 X (2.2M)	T	12/45.9
R1638	7030008280	S.RES ERJ2GEJ 271 X (270)	T	10.9/48.8
R1639	7030005120	S.RES ERJ2GEJ 102 X (1K)	T	14.6/50.5
R1640	7030005090	S.RES ERJ2GEJ 104 X (100K)	T	10.9/31.6
R1641	7030007320	S.RES ERJ2GEJ 225 X (2.2M)	T	13/30.7
R1642	7030005120	S.RES ERJ2GEJ 102 X (1K)	T	22.9/55.1
R1701	7030009320	S.RES ERJ2GEJ 4R7 X (4.7)	T	48/45.3
R1702	7030007280	S.RES ERJ2GEJ 331 X (330)	B	52.1/44.7
R1703	7030007280	S.RES ERJ2GEJ 331 X (330)	B	53.7/43.8
R1704	7030007280	S.RES ERJ2GEJ 331 X (330)	B	53.7/44.7
R1705	7030009320	S.RES ERJ2GEJ 4R7 X (4.7)	T	48/46.2
R1706	7030007280	S.RES ERJ2GEJ 331 X (330)	B	53.6/64.2
R1707	7030007280	S.RES ERJ2GEJ 331 X (330)	B	55.6/64.8
R1708	7030007280	S.RES ERJ2GEJ 331 X (330)	B	55.6/65.7
R1901	7030005090	S.RES ERJ2GEJ 104 X (100K)	B	20/13.9
R1902	7030011290	S.RES ERJ12YJ1R8U (1.8)	B	12.4/45.8
R1952	7030009980	S.RES ERJ12RSJR15U	B	42.6/102.3
R1953	7030009980	S.RES ERJ12RSJR15U	B	42.6/98.6
R1954	7030005170	S.RES ERJ2GEJ 474 X (470K)	B	42.7/111.3
R1955	7030005511	S.RES ERA3YED 303V (30K)	B	44.8/107.3
R1956	7030005110	S.RES ERJ2GEJ 224 X (220K)	B	33.7/105.1
R1957	7030007350	S.RES ERJ2GEJ 393 X (39K)	B	35.3/104.2
R1958	7030005720	S.RES ERJ2GEJ 563 X (56K)	B	35.3/103.3
R1981	7030008240	S.RES ERJ12Y0R00U	B	83.1/109
R2002	7030010040	S.RES ERJ2GEJ-JPW	B	36.9/12.7
R2003	7030008240	S.RES ERJ12Y0R00U	T	55.7/7.9
R2004	7030004990	S.RES ERJ2GEJ 221 X (220)	B	59.8/9.2
R2005	7030004990	S.RES ERJ2GEJ 221 X (220)	B	59.1/3
R2006	7030004990	S.RES ERJ2GEJ 221 X (220)	B	60.7/3.7
R2007	7030004990	S.RES ERJ2GEJ 221 X (220)	B	60.7/4.6
R2008	7030010040	S.RES ERJ2GEJ-JPW	B	34/17.6
R2010	7030010040	S.RES ERJ2GEJ-JPW	B	32.5/15.1
R2011	7030006620	S.RES ERJ12YJ4R7U (4.7)	B	13.1/26.3
R2012	7030005120	S.RES ERJ2GEJ 102 X (1K)	B	32.4/17.3
R2101	7030005090	S.RES ERJ2GEJ 104 X (100K)	T	26/113.8
R2102	7030005090	S.RES ERJ2GEJ 104 X (100K)	T	33.1/114.3
R2103	7030005090	S.RES ERJ2GEJ 104 X (100K)	T	30.7/123.2
R2104	7030005090	S.RES ERJ2GEJ 104 X (100K)	T	28.1/123.2
R2105	7030005090	S.RES ERJ2GEJ 104 X (100K)	T	32.3/118.7
R2106	7030005720	S.RES ERJ2GEJ 563 X (56K)	T	25/115.5
R2107	7030005720	S.RES ERJ2GEJ 563 X (56K)	T	31.5/114.6
R2108	7030005100	S.RES ERJ2GEJ 154 X (150K)	T	30.7/122.3
R2109	7030007350	S.RES ERJ2GEJ 393 X (39K)	T	27.1/122.3
R2110	7030005090	S.RES ERJ2GEJ 104 X (100K)	T	44.3/111.8
R2111	7030005090	S.RES ERJ2GEJ 104 X (100K)	T	44.7/110
R2112	7030005090	S.RES ERJ2GEJ 104 X (100K)	T	54.1/110.8
R2113	7030005090	S.RES ERJ2GEJ 104 X (100K)	T	54.1/111.7
R2114	7030005100	S.RES ERJ2GEJ 154 X (150K)	T	44.7/112.7
R2115	7030005100	S.RES ERJ2GEJ 154 X (150K)	T	44.7/109.1
R2116	7030005100	S.RES ERJ2GEJ 154 X (150K)	T	54.4/109.9
R2117	7030005100	S.RES ERJ2GEJ 154 X (150K)	T	54.1/112.6
R2118	7030005090	S.RES ERJ2GEJ 104 X (100K)	T	54.1/120.6
R2119	7030005090	S.RES ERJ2GEJ 104 X (100K)	T	54.1/121.8
R2120	7030008300	S.RES ERJ2GEJ 184 X (180K)	T	44.8/122.1
R2121	7030008300	S.RES ERJ2GEJ 184 X (180K)	T	42.9/121.3
R2122	7030005100	S.RES ERJ2GEJ 154 X (150K)	T	54.1/119.7
R2123	7030006610	S.RES ERJ2GEJ 394 X (390K)	T	54.2/122.8
R2124	7030005110	S.RES ERJ2GEJ 224 X (220K)	T	44.8/123
R2125	7030005110	S.RES ERJ2GEJ 224 X (220K)	T	44.8/119.4
R2126	7030010040	S.RES ERJ2GEJ-JPW	T	33.1/116.4
R2128	7030005000	S.RES ERJ2GEJ 471 X (470)	T	32.3/123.2
R2129	7030005000	S.RES ERJ2GEJ 471 X (470)	T	54.1/118.8
R2131	7030005090	S.RES ERJ2GEJ 104 X (100K)	B	39.8/122
R2132	7030005090	S.RES ERJ2GEJ 104 X (100K)	T	42.8/115.1
R2133	7030005090	S.RES ERJ2GEJ 104 X (100K)	T	40.6/114.1
R2134	7030005090	S.RES ERJ2GEJ 104 X (100K)	T	36.5/114.1
R2135	7030005090	S.RES ERJ2GEJ 104 X (100K)	T	34.9/114.2
R2136	7030005000	S.RES ERJ2GEJ 471 X (470)	T	26.5/123.2
R2137	7030005230	S.RES ERJ2GEJ 334 X (330K)	T	43.3/123.7
R2138	7030005230	S.RES ERJ2GEJ 334 X (330K)	T	42.9/122.2
R2139	7030004980	S.RES ERJ2GEJ 101 X (100)	T	25/116.4
R2140	7030004980	S.RES ERJ2GEJ 101 X (100)	T	32/115.5
R2141	7030010040	S.RES ERJ2GEJ-JPW	T	44.7/113.6
R2142	7030010040	S.RES ERJ2GEJ-JPW	T	52.7/108.9
R2143	7030010040	S.RES ERJ2GEJ-JPW	T	56/109.9
R2144	7030010040	S.RES ERJ2GEJ-JPW	T	51.3/115.1
R2145	7030010040	S.RES ERJ2GEJ-JPW	T	58.1/123.6
R2146	7030010040	S.RES ERJ2GEJ-JPW	T	46.3/124
R2147	7030010040	S.RES ERJ2GEJ-JPW	T	46/118.5
R2151	7030005240	S.RES ERJ2GEJ 473 X (47K)	T	52.3/101.7
R2152	7030005120	S.RES ERJ2GEJ 102 X (1K)	T	56.5/107.1
R2153	7030005240	S.RES ERJ2GEJ 473 X (47K)	T	24.8/112.5
R2154	7030005120	S.RES ERJ2GEJ 102 X (1K)	T	25.6/111.6
R2155	7030005240	S.RES ERJ2GEJ 473 X (47K)	T	46.1/104.6
R2156	7030005120	S.RES ERJ2GEJ 102 X (1K)	T	46.1/105.5
R2157	7030005530	S.RES ERJ2GEJ 100 X (10)	B	33.3/120.8
R2158	7030005530	S.RES ERJ2GEJ 100 X (10)	B	33.3

[MAIN UNIT]

REF NO.	PARTS NO.	DESCRIPTION	M.	H/V LOCATION
R2164	7030005530	S.RES ERJ2GEJ 100 X (10)	B	30.2/94.7
R2165	7030005530	S.RES ERJ2GEJ 100 X (10)	B	29.3/95.9
R2166	7030005530	S.RES ERJ2GEJ 100 X (10)	T	51.8/93.3
R2167	7030005530	S.RES ERJ2GEJ 100 X (10)	T	51.8/94.2
R2168	7030005530	S.RES ERJ2GEJ 100 X (10)	T	51.8/95.1
R2169	7030005120	S.RES ERJ2GEJ 102 X (1K)	T	8.8/118.5
R2170	7030005170	S.RES ERJ2GEJ 474 X (470K)	T	5/104.5
R2171	7030005240	S.RES ERJ2GEJ 473 X (47K)	T	9.7/114.2
R2172	7030005240	S.RES ERJ2GEJ 473 X (47K)	T	5/112.4
R2174	7030005170	S.RES ERJ2GEJ 474 X (470K)	T	5/105.4
R2175	7030005170	S.RES ERJ2GEJ 474 X (470K)	T	5/111.5
R2176	7030005170	S.RES ERJ2GEJ 474 X (470K)	T	11.3/114.2
R2177	7030005210	S.RES ERJ2GEJ 822 X (8.2K)	T	3.3/108
R2202	7030010040	S.RES ERJ2GEJ-JPW	T	26.5/124.1
R2203	7030005080	S.RES ERJ2GEJ 823 X (82K)	T	25/122.4
R2204	7030005050	S.RES ERJ2GEJ 103 X (10K)	T	23.4/122.7
R2205	7030005040	S.RES ERJ2GEJ 472 X (4.7K)	T	18.2/118.2
R2206	7030007270	S.RES ERJ2GEJ 151 X (150)	T	12.6/118.8
R2207	7030005090	S.RES ERJ2GEJ 104 X (100K)	T	23.1/121.5
R2208	7030005090	S.RES ERJ2GEJ 104 X (100K)	T	19/119.2
R2209	7030004980	S.RES ERJ2GEJ 101 X (100)	T	21/116.5
R2211	7030005230	S.RES ERJ2GEJ 334 X (330K)	T	14.5/123.3
R2212	7030005310	S.RES ERJ2GEJ 124 X (120K)	T	12.9/123.3
R2213	7030008010	S.RES ERJ2GEJ 123 X (12K)	T	12.4/124.2
R2214	7030005050	S.RES ERJ2GEJ 103 X (10K)	T	8.8/117.6
R2215	7030005040	S.RES ERJ2GEJ 472 X (4.7K)	T	11.1/120.6
R2217	7030007280	S.RES ERJ2GEJ 331 X (330)	T	24.9/121.5
R2218	7030007270	S.RES ERJ2GEJ 151 X (150)	T	15.5/127.5
R2219	7030007280	S.RES ERJ2GEJ 331 X (330)	T	17.7/126.1
R2220	7030008280	S.RES ERJ2GEJ 271 X (270)	T	16.1/126.1
R2221	7030005050	S.RES ERJ2GEJ 103 X (10K)	T	9.5/120.5
R2230	7030010900	S.RES ERJ3GEVJ 750 V (75)	T	40.4/105.8
R2231	7030005050	S.RES ERJ2GEJ 103 X (10K)	T	4.5/118.2
R2232	7030005050	S.RES ERJ2GEJ 103 X (10K)	T	54.7/117.5
R2251	7030004990	S.RES ERJ2GEJ 221 X (220)	T	6.1/96.9
R2254	7030004990	S.RES ERJ2GEJ 221 X (220)	B	6.8/100.7
R2255	7030004990	S.RES ERJ2GEJ 221 X (220)	B	6.8/101.6
R2256	7030004990	S.RES ERJ2GEJ 221 X (220)	B	6.8/102.5
R2257	7030004990	S.RES ERJ2GEJ 221 X (220)	B	75.3/109
R2258	7030004990	S.RES ERJ2GEJ 221 X (220)	B	70.9/106.5
R2259	7030004990	S.RES ERJ2GEJ 221 X (220)	B	75.3/107.8
R2260	7030004990	S.RES ERJ2GEJ 221 X (220)	B	71/105.6
R2261	7030004990	S.RES ERJ2GEJ 221 X (220)	B	75.3/106.6
R2262	7030004990	S.RES ERJ2GEJ 221 X (220)	B	71.4/104.5
R2263	7030004990	S.RES ERJ2GEJ 221 X (220)	B	75.6/104.5
R2264	7030004990	S.RES ERJ2GEJ 221 X (220)	B	72.2/103.6
R2267	7030004990	S.RES ERJ2GEJ 221 X (220)	T	78.6/104.1
R2268	7030004990	S.RES ERJ2GEJ 221 X (220)	T	78.6/103.2
R2269	7030004990	S.RES ERJ2GEJ 221 X (220)	T	78.6/102.3
R2270	7030004970	S.RES ERJ2GEJ 470 X (47)	T	76.6/101.8
R2271	7030004990	S.RES ERJ2GEJ 221 X (220)	T	76.6/100.9
R2272	7030004990	S.RES ERJ2GEJ 221 X (220)	B	78.1/97.8
R2273	7030004990	S.RES ERJ2GEJ 221 X (220)	B	78.1/98.9
R2274	7030005000	S.RES ERJ2GEJ 471 X (470)	T	14.1/89.7
R2277	7030005090	S.RES ERJ2GEJ 104 X (100K)	T	19.2/89.5
R2278	7030005090	S.RES ERJ2GEJ 104 X (100K)	T	19.2/90.4
R2279	7030005120	S.RES ERJ2GEJ 102 X (1K)	T	66.2/107
R2280	7030004980	S.RES ERJ2GEJ 101 X (100)	B	69.7/110.2
R2281	7030004990	S.RES ERJ2GEJ 221 X (220)	T	7.1/101.5
R2301	7030007250	S.RES ERJ2GEJ 220 X (22)	T	28.3/106.6
R2302	7030008290	S.RES ERJ2GEJ 183 X (18K)	T	28.9/108
R2303	7030005710	S.RES ERJ2GEJ 121 X (120)	T	31.2/110.8
R2304	7030010900	S.RES ERJ3GEVJ 750 V (75)	T	77.7/112
R2311	7030006101	S.RES ERA3YED 183V (18K)	B	67.6/107.1
R2312	7030006571	S.RES ERA3YED 392V (3.9K)	B	68.5/108.3
R2401	7030005000	S.RES ERJ2GEJ 471 X (470)	B	78.7/29.6
R2402	7030005050	S.RES ERJ2GEJ 103 X (10K)	B	81.3/29.6
R2405	7030010040	S.RES ERJ2GEJ-JPW	T	91.9/5.8
R2406	7030004990	S.RES ERJ2GEJ 221 X (220)	B	90.3/100.7
R2408	7030004970	S.RES ERJ2GEJ 470 X (47)	B	90.3/99.8
R2409	7030004990	S.RES ERJ2GEJ 221 X (220)	B	87.1/68.1
R2410	7030004990	S.RES ERJ2GEJ 221 X (220)	B	90.3/65.5
R2411	7030004990	S.RES ERJ2GEJ 221 X (220)	B	87.3/67.2
R2412	7030004990	S.RES ERJ2GEJ 221 X (220)	B	91.3/68.5
R2413	7030004990	S.RES ERJ2GEJ 221 X (220)	B	87.3/66.3
R2414	7030004990	S.RES ERJ2GEJ 221 X (220)	B	90.3/64.6
R2415	7030004990	S.RES ERJ2GEJ 221 X (220)	B	87.3/65.4
R2416	7030004990	S.RES ERJ2GEJ 221 X (220)	B	90.3/63.7
R2417	7030010040	S.RES ERJ2GEJ-JPW	B	51.4/141.2
R2418	7030010040	S.RES ERJ2GEJ-JPW	T	93.3/7.8
R2501	7030005090	S.RES ERJ2GEJ 104 X (100K)	B	8.3/93.3
R2502	7030005090	S.RES ERJ2GEJ 104 X (100K)	B	8/95.1
R2503	7030008410	S.RES ERJ2GEJ 392 X (3.9K)	B	8/91.5
R2505	7030008410	S.RES ERJ2GEJ 392 X (3.9K)	B	10.6/89.2
R2506	7030005720	S.RES ERJ2GEJ 563 X (56K)	B	9.4/90
R2507	7030004980	S.RES ERJ2GEJ 101 X (100)	B	16.4/89.9
R2508	7030005120	S.RES ERJ2GEJ 102 X (1K)	B	10.4/88.3
R2509	7030005120	S.RES ERJ2GEJ 102 X (1K)	B	15.7/88.3
R2510	7030005120	S.RES ERJ2GEJ 102 X (1K)	B	17.4/92.8
R2513	7030005000	S.RES ERJ2GEJ 471 X (470)	B	15.8/94
R2551	7030005120	S.RES ERJ2GEJ 102 X (1K)	B	42.9/123.2
R2552	7030005120	S.RES ERJ2GEJ 102 X (1K)	B	42.9/122.3
R2555	7030004980	S.RES ERJ2GEJ 101 X (100)	B	51.4/119.3
R2556	7030005040	S.RES ERJ2GEJ 472 X (4.7K)	B	44.5/125.2
R2559	7030010040	S.RES ERJ2GEJ-JPW	B	49.5/124.6
R2560	7030008410	S.RES ERJ2GEJ 392 X (3.9K)	B	49.5/125.5
R2561	7030008410	S.RES ERJ2GEJ 392 X (3.9K)	B	52.9/124.7

[MAIN UNIT]

REF NO.	PARTS NO.	DESCRIPTION	M.	H/V LOCATION
R2562	7030008410	S.RES ERJ2GEJ 392 X (3.9K)	B	53.9/122.8
R2564	7030005090	S.RES ERJ2GEJ 104 X (100K)	B	46.1/126.1
R2565	7030009280	S.RES ERJ2GEJ 391 X	B	41.8/116.9
R2566	7030005050	S.RES ERJ2GEJ 103 X (10K)	B	59/126.8
R2567	7030005050	S.RES ERJ2GEJ 103 X (10K)	B	60.6/126.8
R2568	7030005040	S.RES ERJ2GEJ 472 X (4.7K)	B	47.8/124.7
R2569	7030005040	S.RES ERJ2GEJ 472 X (4.7K)	B	46.1/125.2
R2601	7030010040	S.RES ERJ2GEJ-JPW	B	66.7/123.4
R2602	7030005000	S.RES ERJ2GEJ 471 X (470)	B	57.2/122.6
R2603	7030005240	S.RES ERJ2GEJ 473 X (47K)	B	63.4/121.7
R2604	7030008400	S.RES ERJ2GEJ 182 X (1.8K)	B	66.7/124.3
R2605	7030005120	S.RES ERJ2GEJ 102 X (1K)	B	65.5/126
R2607	7030010040	S.RES ERJ2GEJ-JPW	T	40.5/132.1
R2608	7030009320	S.RES ERJ2GEJ 477 X (4.7)	B	83.9/132.7
R2611	7030005050	S.RES ERJ2GEJ 103 X (10K)	B	33.9/124.8
R2612	7030005090	S.RES ERJ2GEJ 104 X (100K)	B	38.4/125.4
R2613	7030005080	S.RES ERJ2GEJ 823 X (82K)	B	38.4/123.6
R2614	7030005120	S.RES ERJ2GEJ 102 X (1K)	B	34.7/126.6
R2617	7030005040	S.RES ERJ2GEJ 472 X (4.7K)	T	63.3/111.1
R2618	7030007340	S.RES ERJ2GEJ 153 X (15K)	T	69.3/112.6
R2619	7030005060	S.RES ERJ2GEJ 333 X (33K)	T	63.3/112.1
R2620	7030005120	S.RES ERJ2GEJ 102 X (1K)	T	78.1/100.3
R2621	7030005120	S.RES ERJ2GEJ 102 X (1K)	T	78.1/99.4
R2623	7030005240	S.RES ERJ2GEJ 473 X (47K)	T	9.8/112.9
R2624	7030004970	S.RES ERJ2GEJ 470 X (47)	B	86.8/122
R2628	7030005240	S.RES ERJ2GEJ 473 X (47K)	B	61.8/121.7
C5	4030017460	S.CER ECJ0EB1E102K	B	47.5/30.7
C6	4030018960	S.CER C3216 JB 1C 106MT-N	T	66.3/12
C7	4030017330	S.CER ECJ0EF1C104Z	T	73.1/12.2
C8	4030017330	S.CER ECJ0EF1C104Z	T	77.2/9.1
C9	4030017330	S.CER ECJ0EF1C104Z	T	73.1/14
C10	4030017330	S.CER ECJ0EF1C104Z	T	74.8/14.9
C11	4030017330	S.CER ECJ0EF1C104Z	T	73/17.6
C12	4030017330	S.CER ECJ0EF1C104Z	T	76.4/16.7
C13	4030017330	S.CER ECJ0EF1C104Z	T	72.6/16.7
C14	4030017460	S.CER ECJ0EB1E102K	T	67.7/16.5
C15	4030017460	S.CER ECJ0EB1E102K	T	63.7/14.7
C16	4030017460	S.CER ECJ0EB1E102K	T	63.7/15.6
C17	4030017460	S.CER ECJ0EB1E102K	T	62.3/18.8
C18	4030017620	S.CER ECJ0EC1H100C	T	60.7/18.9
C21	4030017730	S.CER ECJ0EB1E471K	T	64.5/13.8
C25	4030017580	S.CER ECJ0EC1H060C	T	55.2/17.8
C26	4030017660	S.CER ECJ0EC1H330J	T	55.2/18.7
C27	4030017780	S.CER ECJ0EB1E472K	T	51.6/20.5
C28	4030017530	S.CER ECJ0EC1H0R5B	T	53.8/17.1
C29	4030017590	S.CER ECJ0EC1H070C	T	51.7/19.6
C30	4030017730	S.CER ECJ0EB1E471K	T	45.8/17.5
C31	4030017530	S.CER ECJ0EC1H0R5B	T	53.8/16.2
C32	4030017660	S.CER ECJ0EC1H330J	T	52.1/17.4
C33	4030017580	S.CER ECJ0EC1H060C	T	52.2/16.5
C34	4030017380	S.CER ECJ0EC1H050B	T	56/15
C35	4030017380	S.CER ECJ0EC1H050B	T	55.9/12.4
C36	4030017730	S.CER ECJ0EB1E471K	T	51/15.6
C37	4030017780	S.CER ECJ0EB1E472K	T	70.4/11.3
C38	4030017780	S.CER ECJ0EB1E472K	T	45.8/18.4
C40	4030017730	S.CER ECJ0EB1E471K	T	73.1/13.1
C41	4030017730	S.CER ECJ0EB1E471K	T	66.9/19.6
C42	4030017730	S.CER ECJ0EB1E471K	T	70.4/12.2
C43	4030017420	S.CER ECJ0EC1H470J	T	45.8/16.6
C44	4030017420	S.CER ECJ0EC1H470J	T	48/11.7
C50	4030017640	S.CER ECJ0EC1H150J	B	80.4/13.6
C51	4030017640	S.CER ECJ0EC1H150J	B	79.9/11.8
C52	4030017430	S.CER ECJ0EC1H101J	B	79.9/12.7
C53	4030016930	S.CER ECJ0EB1A104K	B	79.6/22
C54	4030016930	S.CER ECJ0EB1A104K	T	79.8/12.9
C55	4030016930	S.CER ECJ0EB1A104K	T	78.1/17.9
C56	4030018860	S.CER ECJ0EB0J105K	B	65.5/22.7
C58	4030017710	S.CER ECJ0EC1H181J	T	72.2/19.4
C59	4030017710	S.CER ECJ0EC1H181J	T	65.4/23.7
C101	4030017330	S.CER ECJ0EF1C104Z	T	10.3/15.5
C102	4030017330	S.CER ECJ0EF1C104Z	T	13.2/16.9
C103	4030017330	S.CER ECJ0EF1C104Z	T	13.2/17.8
C104	4030017330	S.CER ECJ0EF1C104Z	T	3.3/29.9
C105	4030017330	S.CER ECJ0EF1C104Z	T	13.2/19.6
C106	4030017850	S.CER C2012 CH 1H 272J-T	T	23.7/10.9
C107	4030017330	S.CER ECJ0EF1C104Z	T	19.2/12.9
C108	4030017330	S.CER ECJ0EF1C104Z	T	36.5/16.6
C109	4030017330	S.CER ECJ0EF1C104Z	T	25.2/14
C110	4030017800	S.CER C1608 CH 1H 561J-T	T	27.8/7.7
C111	4030018590	S.CER C1608 CH 1H 122J-T	T	29.1/5
C112	4030017330	S.CER ECJ0EF1C104Z	T	23.8/5.3
C114	4030018600	S.CER C1608 CH 1H 152J-T	T	25.1/15
C115	4030008490	S.CER C2012 JB 1H 682K-T	T	24.8/16.7
C116	4030017850	S.CER C2012 CH 1H 272J-T	T	24.8/18.4
C117	4030017330	S.CER ECJ0EF1C104Z	T	19.8/7

[MAIN UNIT]

REF NO.	PARTS NO.	DESCRIPTION	M.	H/V LOCATION
C208	4030017330	S.CER ECJ0EF1C104Z	T	19.7/31.2
C209	4030017680	S.CER ECJ0EC1H820J	T	18.5/41.4
C210	4030017610	S.CER ECJ0EC1H090C	T	18.5/40.5
C211	4030017700	S.CER ECJ0EC1H151J	T	18.5/42.3
C212	4030017650	S.CER ECJ0EC1H270J	T	23.2/39.2
C213	4030017510	S.CER ECJ0EC1H680J	T	21.8/43.4
C214	4030018820	S.CER ECJ0EB1H561K	T	31.7/54.4
C215	4030017440	S.CER ECJ0EC1H221J	T	37/54.6
C226	4030017330	S.CER ECJ0EF1C104Z	T	24.1/43.4
C227	4030017330	S.CER ECJ0EF1C104Z	T	19.7/30.3
C228	4030017430	S.CER ECJ0EC1H101J	T	28.1/39.2
C229	4030017440	S.CER ECJ0EC1H221J	T	29.7/39.2
C237	4030017500	S.CER ECJ0EC1H560J	T	28.1/38.2
C238	4030017330	S.CER ECJ0EF1C104Z	T	21.9/30.9
C239	4030017330	S.CER ECJ0EF1C104Z	B	24.7/41.4
C240	4030017400	S.CER ECJ0EC1H220J	B	28.1/43.6
C241	4030017580	S.CER ECJ0EC1H060C	B	31.5/40.1
C242	4030017680	S.CER ECJ0EC1H820J	B	31.5/41
C243	4030018630	S.CER C2012 CH 1H 472J-T	T	32.5/57.8
C244	4030018680	S.CER C2012 CH 1H 822J-T	T	36.8/57.8
C245	4030017330	S.CER ECJ0EF1C104Z	T	45.8/63.2
C246	4030018600	S.CER C1608 CH 1H 152J-T	T	36.5/56.1
C247	4030017860	S.CER C2012 CH 1H 332J-T	T	40.3/54.1
C248	4030018630	S.CER C2012 CH 1H 472J-T	T	43.8/57.9
C249	4030017330	S.CER ECJ0EF1C104Z	B	24.9/56.4
C250	4030017330	S.CER ECJ0EF1C104Z	B	24.9/53.3
C251	4030018590	S.CER C1608 CH 1H 122J-T	T	30.5/51
C252	4030011340	S.CER C1608 CH 1H 471J-T	T	31.9/48.6
C253	4030018630	S.CER C2012 CH 1H 472J-T	T	29.1/53.3
C254	4030018620	S.CER C1608 CH 1H 222J-T	T	38.1/50.8
C255	4030018580	S.CER C1608 CH 1H 821J-T	T	32.6/55.9
C256	4030010760	S.CER C1608 CH 1H 331J-T	T	38.1/52.1
C257	4030018610	S.CER C1608 CH 1H 182J-T	T	34.4/53.4
C258	4030017870	S.CER C1608 CH 1H 681J-T	T	40.7/52.2
C259	4030018590	S.CER C1608 CH 1H 122J-T	T	37.1/53.4
C260	4030017870	S.CER C1608 CH 1H 681J-T	T	40.7/47.9
C261	4030017780	S.CER ECJ0EB1E472K	B	37.9/56.2
C262	4030017780	S.CER ECJ0EB1E472K	B	37.9/53.8
C263	4030017330	S.CER ECJ0EF1C104Z	B	24.5/50.2
C264	4030017330	S.CER ECJ0EF1C104Z	B	23.9/47.1
C265	4030011280	S.CER C1608 CH 1H 271J-T	B	36.4/46
C266	4030017700	S.CER ECJ0EC1H151J	B	31/44.1
C267	4030018590	S.CER C1608 CH 1H 122J-T	B	36.4/49.6
C268	4030018580	S.CER C1608 CH 1H 821J-T	B	31.7/42.9
C269	4030017710	S.CER ECJ0EC1H181J	B	36.5/47.1
C270	4030017430	S.CER ECJ0EC1H101J	B	32.6/44.1
C271	4030011330	S.CER C1608 CH 1H 391J-T	B	36.4/48.3
C272	4030011280	S.CER C1608 CH 1H 271J-T	B	36.3/43.8
C273	4030011330	S.CER C1608 CH 1H 391J-T	B	38.8/47.3
C274	4030017730	S.CER ECJ0EB1E471K	B	34.2/43.7
C275	4030017780	S.CER ECJ0EB1E472K	B	42.9/49.6
C276	4030017780	S.CER ECJ0EB1E472K	B	39.2/46.2
C278	4030017330	S.CER ECJ0EF1C104Z	T	30.9/31.8
C279	4030017330	S.CER ECJ0EF1C104Z	T	31/43.8
C281	4030017330	S.CER ECJ0EF1C104Z	T	33/31.7
C282	4030017580	S.CER ECJ0EC1H060C	B	31.5/39.2
C283	4030017330	S.CER ECJ0EF1C104Z	B	35.8/35.8
C284	4030017780	S.CER ECJ0EB1E472K	B	42.6/43.3
C285	4030017380	S.CER ECJ0EC1H050B	B	33.1/39.5
C286	4030017510	S.CER ECJ0EC1H680J	B	34.7/39.5
C287	4030017690	S.CER ECJ0EC1H121J	B	36.5/37.8
C288	4030017680	S.CER ECJ0EC1H820J	B	34.2/36.3
C289	4030017420	S.CER ECJ0EC1H470J	B	36.3/36.7
C290	4030018600	S.CER C1608 CH 1H 152J-T	B	38.8/37.6
C291	4030017680	S.CER ECJ0EC1H820J	B	37.9/36.5
C292	4030017330	S.CER ECJ0EF1C104Z	T	30.9/30
C293	4030017780	S.CER ECJ0EB1E472K	B	38.1/34.8
C294	4030017440	S.CER ECJ0EC1H221J	T	38.6/49.6
C295	4030017510	S.CER ECJ0EC1H680J	T	40.4/51.2
C301	4030017330	S.CER ECJ0EF1C104Z	T	47/30.1
C302	4030017330	S.CER ECJ0EF1C104Z	B	56.1/30.7
C303	4030017330	S.CER ECJ0EF1C104Z	T	51.5/33.6
C305	4030017330	S.CER ECJ0EF1C104Z	T	59.9/34.7
C307	4030017330	S.CER ECJ0EF1C104Z	T	59.9/35.6
C308	4030017330	S.CER ECJ0EF1C104Z	T	60.7/36.5
C309	4030017330	S.CER ECJ0EF1C104Z	T	62.8/36.9
C310	4030017330	S.CER ECJ0EF1C104Z	T	60.9/30.1
C311	4030017330	S.CER ECJ0EF1C104Z	T	50.1/32.6
C312	4030017330	S.CER ECJ0EF1C104Z	T	64.5/36.1
C313	4030017380	S.CER ECJ0EC1H050B	T	46.4/23
C314	4030017660	S.CER ECJ0EC1H330J	T	64.8/35.2
C315	4030017340	S.CER ECJ0EC1H010B	T	49.2/22.9
C316	4030017630	S.CER ECJ0EC1H120J	T	66.1/36.1
C317	4030017600	S.CER ECJ0EC1H080C	T	51.4/23.8
C318	4030017680	S.CER ECJ0EC1H820J	T	66.4/35.2
C319	4030017570	S.CER ECJ0EC1H040B	T	53/24.3
C320	4030017570	S.CER ECJ0EC1H040B	T	69.6/37.1
C321	4030017580	S.CER ECJ0EC1H060C	T	58.6/24.4
C322	4030017670	S.CER ECJ0EC1H390J	T	69/32.2
C323	4030017590	S.CER ECJ0EC1H070C	T	60.4/24.2
C324	4030017330	S.CER ECJ0EF1C104Z	T	74.7/38.6
C325	4030017360	S.CER ECJ0EC1H030B	T	62/24.6
C326	4030017780	S.CER ECJ0EB1E472K	T	47.6/47.1
C401	4030017330	S.CER ECJ0EF1C104Z	T	71/30.8
C413	4030017330	S.CER ECJ0EF1C104Z	T	80.6/23.9
C415	4030017330	S.CER ECJ0EF1C104Z	T	71.9/24
C418	4030017330	S.CER ECJ0EF1C104Z	T	67.4/24.8

[MAIN UNIT]

REF NO.	PARTS NO.	DESCRIPTION	M.	H/V LOCATION
C422	4030017330	S.CER ECJ0EF1C104Z	T	80/28.6
C423	4030017330	S.CER ECJ0EF1C104Z	T	67.4/23.9
C424	4030017330	S.CER ECJ0EF1C104Z	T	83.2/21
C425	4030017330	S.CER ECJ0EF1C104Z	T	86.9/27.6
C426	4030017330	S.CER ECJ0EF1C104Z	T	78.6/19.8
C427	4030017330	S.CER ECJ0EF1C104Z	T	80/27.7
C429	4030017460	S.CER ECJ0EB1E102K	T	81.8/25.3
C431	4030017330	S.CER ECJ0EF1C104Z	T	88.5/26.7
C432	4030017780	S.CER ECJ0EB1E472K	B	88.5/19.3
C433	4030017780	S.CER ECJ0EB1E472K	T	88.8/20.3
C434	4030017780	S.CER ECJ0EB1E472K	T	86.7/22.9
C511	4030017460	S.CER ECJ0EB1E102K	T	41.8/26.8
C512	4030017780	S.CER ECJ0EB1E472K	T	93.6/33.5
C513	4030017330	S.CER ECJ0EF1C104Z	T	88.4/28.3
C514	4030017330	S.CER ECJ0EF1C104Z	B	88.3/31.7
C515	4030017780	S.CER ECJ0EB1E472K	T	81.7/33.2
C516	4030017580	S.CER ECJ0EC1H060C	T	86.1/38.7
C518	4030017570	S.CER ECJ0EC1H040B	T	86.9/36.5
C525	4030017330	S.CER ECJ0EF1C104Z	T	81.8/32.3
C526	4030016790	S.CER ECJ0EB1C103K	T	77.9/38.2
C527	4030017330	S.CER ECJ0EF1C104Z	T	79.5/37.9
C528	4030017330	S.CER ECJ0EF1C104Z	T	89.7/35.1
C529	4030017670	S.CER ECJ0EC1H390J	T	91.3/33.8
C530	4030017460	S.CER ECJ0EB1E102K	B	87.7/34.1
C602	4030017570	S.CER ECJ0EC1H040B	B	85.7/39.6
C603	4030017780	S.CER ECJ0EB1E472K	T	89.1/40.1
C604	4030017780	S.CER ECJ0EB1E472K	T	94/46.5
C605	4030017620	S.CER ECJ0EC1H100C	T	86/44.2
C606	4030017620	S.CER ECJ0EC1H100C	B	85.7/41.4
C608	4030017550	S.CER ECJ0EC1H1R5B	B	82.7/43.8
C609	4030017580	S.CER ECJ0EC1H060C	B	78.6/46.8
C610	4030017620	S.CER ECJ0EC1H100C	B	80.7/48.1
C611	4030017780	S.CER ECJ0EB1E472K	B	85.1/37.5
C612	4030017610	S.CER ECJ0EC1H090C	T	79.5/40.5
C613	4030017620	S.CER ECJ0EC1H100C	T	76.5/43.7
C614	4030017780	S.CER ECJ0EB1E472K	T	69.6/38.8
C615	4030017780	S.CER ECJ0EB1E472K	T	64.3/43
C616	4030017780	S.CER ECJ0EB1E472K	T	77.4/39.5
C617	4030017620	S.CER ECJ0EC1H100C	B	85.7/40.5
C618	4030017620	S.CER ECJ0EC1H100C	B	80.7/49
C701	4030017330	S.CER ECJ0EF1C104Z	T	59/50.6
C702	4030017330	S.CER ECJ0EF1C104Z	T	63/45
C703	4510008630	S.ELE 16 CE 47 FE	B	59/44.9
C704	4030017780	S.CER ECJ0EB1E472K	T	58.6/42.9
C705	4030017600	S.CER ECJ0EC1H080C	T	59.6/45.1
C707	4030017330	S.CER ECJ0EF1C104Z	T	64.2/52.9
C708	4030017460	S.CER ECJ0EB1E102K	T	64.5/55
C709	4030017780	S.CER ECJ0EB1E472K	T	60.7/58.6
C710	4030017780	S.CER ECJ0EB1E472K	T	62.3/58.6
C711	4030017460	S.CER ECJ0EB1E102K	T	57.1/50.6
C712	4030017600	S.CER ECJ0EB1E472K	T	52.4/50.2
C714	4030017460	S.CER ECJ0EB1E102K	T	56.2/49.7
C715	4030017780	S.CER ECJ0EB1E472K	T	52.1/53.2
C716	4030017340	S.CER ECJ0EC1H010B	T	55.3/51.0
C717	4030017780	S.CER ECJ0EB1E472K	T	51.2/52.3
C718	4030017780	S.CER ECJ0EB1E472K	T	56.9/55.1
C719	4030017340	S.CER ECJ0EC1H010B	T	61.1/53.9
C720	4030017380	S.CER ECJ0EC1H050B	T	59.3/42
C721	4030017780	S.CER ECJ0EB1E472K	T	51.2/49.6
C801	4030017330	S.CER ECJ0EF1C104Z	T	71.5/64
C803	4030017780	S.CER ECJ0EB1E472K	T	65.3/61.8
C804	4030017330	S.CER ECJ0EF1C104Z	T	91.9/58
C805	4030017460	S.CER ECJ0EB1E102K	T	83.5/55.8
C807	4030017330	S.CER ECJ0EF1C104Z	T	60.6/66.7
C808	4030017870	S.CER C1608 CH 1H 681J-T	T	60.3/65.5
C809	4030018630	S.CER C2012 CH 1H 472J-T	T	57.4/66.8
C810	4030017700	S.CER ECJ0EC1H151J	T	63.9/68.5
C811	4030017700	S.CER ECJ0EC1H151J	T	63.9/69.4
C812	4030017700	S.CER ECJ0EC1H151J	T	60.1/69.4
C813	4030017700	S.CER ECJ0EC1H151J	T	60.1/68.5
C814	4030017330	S.CER ECJ0EF1C104Z	T	88.5/57.1
C815	4030017460	S.CER ECJ0EB1E102K	T	86.6/60.6
C816	4030017400	S.CER ECJ0EC1H220J	T	85.7/59.7
C817	4030017400	S.CER ECJ0EC1H220J	T	84/61.7
C818	4030018590	S.CER C1608 CH 1H 122J-T	T	54.6/65.6
C819	4030017850	S.CER C2012 CH 1H 272J-T	T	51.6/65.8
C901	4030017330	S.CER ECJ0EF1C104Z	T	38.4/71.3
C910	4030017710	S.CER ECJ0EC1H181J	T	39.2/65.6
C911	4030017700	S.CER ECJ0EC1H151J	T	47.9/74.7
C913	4030017330	S.CER ECJ0EF1C104Z	T	38.2/61.1
C914	4030017330	S.CER ECJ0EF1C104Z	T	39.2/63.6
C916	4030017330	S.CER ECJ0EF1C104Z	T	33.9/61.9
C917	4030017780	S.CER ECJ0EB1E472K	T	35.6/63.2
C918	4030017330	S.CER ECJ0EF1C104Z	T	34.2/67.5
C920	4030017460	S.CER ECJ0EB1E102K	T	38.4/74.2
C921	4030017330	S.CER ECJ0EF1C104Z	T	34.2/70.2
C922	4030017330	S.CER ECJ0EF1C104Z	T	29.4/73
C923	4030017330	S.CER ECJ0EF1C104Z	T	29.9/72.1
C924	4030017780	S.CER ECJ0EB1E472K	T	41.2/74.1
C925	4030017700	S.CER ECJ0EC1H151J	B	31.4/73
C1001	4030017780	S.CER ECJ0EB1E472K	T	31.7/71.2

[MAIN UNIT]

REF NO.	PARTS NO.	DESCRIPTION	M.	H/V LOCATION
C1022	4510008630	S.ELE 16 CE 47 FE	B	6.1/86
C1023	4510008630	S.ELE 16 CE 47 FE	B	5.7/77.4
C1101	4030017490	S.CER C1608 JB 1A 105K-T	T	2.5/78.9
C1102	4030017330	S.CER ECJ0EF1C104Z	T	4.6/78
C1104	4030017490	S.CER C1608 JB 1A 105K-T	T	2.5/87.8
C1105	4030018960	S.CER C3216 JB 1C 106MT-N	T	2.9/89.7
C1108	4030017330	S.CER ECJ0EF1C104Z	T	2.3/91.3
C1201	4030017330	S.CER ECJ0EF1C104Z	T	26.6/80.6
C1202	4030017330	S.CER ECJ0EF1C104Z	T	28.7/80.5
C1203	4030017330	S.CER ECJ0EF1C104Z	T	18.6/79.2
C1204	4030018960	S.CER C3216 JB 1C 106MT-N	T	9/76.9
C1206	4030017780	S.CER ECJ0EB1E472K	T	14.3/79.4
C1207	4030017780	S.CER ECJ0EB1E472K	T	12.7/78.5
C1208	4030018080	S.CER ECJ0EB1H182K	T	12.9/85
C1209	4030018820	S.CER ECJ0EB1H561K	T	12.9/84.1
C1210	4030017780	S.CER ECJ0EB1E472K	T	11.3/84.1
C1211	4030017490	S.CER C1608 JB 1A 105K-T	T	9.2/84.5
C1212	4030017490	S.CER C1608 JB 1A 105K-T	T	6.7/87.8
C1213	4030017330	S.CER ECJ0EF1C104Z	T	21.8/78.3
C1301	4030017330	S.CER ECJ0EF1C104Z	T	15.2/73.6
C1302	4030017330	S.CER ECJ0EF1C104Z	T	15.1/67.3
C1303	4030018860	S.CER ECJ0EB0J105K	T	11.3/67.3
C1304	4030017330	S.CER ECJ0EF1C104Z	T	14.3/69.2
C1305	4030017330	S.CER ECJ0EF1C104Z	T	11.6/65.5
C1306	4030017330	S.CER ECJ0EF1C104Z	T	10.9/60.3
C1307	4030017330	S.CER ECJ0EF1C104Z	T	16.2/65.6
C1308	4030017330	S.CER ECJ0EF1C104Z	T	14.5/60.3
C1309	4030017330	S.CER ECJ0EF1C104Z	T	3.8/50.8
C1310	4030017330	S.CER ECJ0EF1C104Z	T	16.2/62.9
C1311	4030018960	S.CER C3216 JB 1C 106MT-N	T	5.4/58.5
C1312	4030018860	S.CER ECJ0EB0J105K	T	13/66.4
C1401	4030017330	S.CER ECJ0EF1C104Z	B	46.6/77.3
C1402	4030017700	S.CER ECJ0EC1H151J	B	42/69.6
C1403	4030017650	S.CER ECJ0EC1H270J	B	45.5/71.4
C1404	4030017700	S.CER ECJ0EC1H151J	B	41.9/70.5
C1405	4030017780	S.CER ECJ0EB1E472K	B	43.6/71.4
C1406	4030017780	S.CER ECJ0EB1E472K	B	42/72.4
C1407	4030017780	S.CER ECJ0EB1E472K	B	44.6/74.3
C1408	4030017780	S.CER ECJ0EB1E472K	B	40.3/79
C1409	4030017780	S.CER ECJ0EB1E472K	B	34.7/79
C1411	4030018860	S.CER ECJ0EB0J105K	B	27/79.9
C1412	4030016950	S.CER ECJ0EB1A473K	B	27/80.8
C1413	4030017490	S.CER C1608 JB 1A 105K-T	B	20.7/77.4
C1414	4030016950	S.CER ECJ0EB1A473K	B	25/77.8
C1415	4510008640	S.ELE 6 CE 100 FE	B	13.2/81.2
C1416	4030016950	S.CER ECJ0EB1A473K	B	20.2/78.5
C1418	4030017350	S.CER ECJ0EC1H020B	B	23/86.6
C1419	4030018390	S.CER ECJ0EB1A563K	B	23/87.5
C1420	4030017420	S.CER ECJ0EC1H470J	B	17.8/83
C1421	4030018960	S.CER C3216 JB 1C 106MT-N	B	19.8/87.3
C1422	4030017640	S.CER ECJ0EC1H150J	B	17.8/82.1
C1423	4610001970	S.TRI TZC3P200A110R00	T	3.8/72.5
C1491	4030017670	S.CER ECJ0EC1H390J	[EUR] B	88.2/29.3
	4030017670	S.CER ECJ0EC1H390J	[FRA]	
	4030017670	S.CER ECJ0EC1H390J	[ESP]	
	4030017400	S.CER ECJ0EC1H220J	[USA]	
	4030017670	S.CER ECJ0EC1H390J	[EXP]	
	4030017670	S.CER ECJ0EC1H390J	[ITR]	
	4030017670	S.CER ECJ0EC1H390J	[UK]	
	4030017400	S.CER ECJ0EC1H220J	[KOR]	
	4030017670	S.CER ECJ0EC1H390J	[AUS]	
	4030017670	S.CER ECJ0EC1H390J	[CHN]	
C1493	4030017660	S.CER ECJ0EC1H330J	B	86.1/33.7
C1494	4030017670	S.CER ECJ0EC1H390J	B	83.6/34
	4030017670	S.CER ECJ0EC1H390J	[FRA]	
	4030017670	S.CER ECJ0EC1H390J	[ESP]	
	4030017420	S.CER ECJ0EC1H470J	[USA]	
	4030017670	S.CER ECJ0EC1H390J	[EXP]	
	4030017670	S.CER ECJ0EC1H390J	[ITR]	
	4030017670	S.CER ECJ0EC1H390J	[UK]	
	4030017420	S.CER ECJ0EC1H470J	[KOR]	
	4030017670	S.CER ECJ0EC1H390J	[AUS]	
	4030017670	S.CER ECJ0EC1H390J	[CHN]	
C1495	4030011280	S.CER C1608 CH 1H 271J-T	[EUR] B	84/32.9
	4030011280	S.CER C1608 CH 1H 271J-T	[FRA]	
	4030011280	S.CER C1608 CH 1H 271J-T	[ESP]	
	4030010760	S.CER C1608 CH 1H 331J-T	[USA]	
	4030011280	S.CER C1608 CH 1H 271J-T	[EXP]	
	4030011280	S.CER C1608 CH 1H 271J-T	[ITR]	
	4030011280	S.CER C1608 CH 1H 271J-T	[UK]	
	4030010760	S.CER C1608 CH 1H 331J-T	[KOR]	
	4030011280	S.CER C1608 CH 1H 271J-T	[AUS]	
	4030011280	S.CER C1608 CH 1H 271J-T	[CHN]	
C1496	4030017660	S.CER ECJ0EC1H330J	B	79.3/35.3
C1498	4030017670	S.CER ECJ0EC1H390J	[EUR] B	79.3/36.2
	4030017670	S.CER ECJ0EC1H390J	[FRA]	
	4030017670	S.CER ECJ0EC1H390J	[ESP]	
	4030017400	S.CER ECJ0EC1H220J	[USA]	
	4030017670	S.CER ECJ0EC1H390J	[EXP]	
	4030017670	S.CER ECJ0EC1H390J	[ITR]	
	4030017670	S.CER ECJ0EC1H390J	[UK]	
	4030017400	S.CER ECJ0EC1H220J	[KOR]	
	4030017670	S.CER ECJ0EC1H390J	[AUS]	
	4030017670	S.CER ECJ0EC1H390J	[CHN]	
C1501	4030017410	S.CER ECJ0EC1H240J	B	79.3/37.1
C1503	4030017330	S.CER ECJ0EF1C104Z	B	78.9/61.9
C1504	4030017510	S.CER ECJ0EC1H680J	B	80.9/36.4

[MAIN UNIT]

REF NO.	PARTS NO.	DESCRIPTION	M.	H/V LOCATION
C1506	4030017780	S.CER ECJ0EB1E472K	B	92.1/28.8
C1507	4030017410	S.CER ECJ0EC1H240J	B	82.5/36.4
C1508	4030017780	S.CER ECJ0EB1E472K	B	77.3/38.6
C1509	4030017780	S.CER ECJ0EB1E472K	B	72.4/39.1
C1510	4030017780	S.CER ECJ0EB1E472K	B	72.4/41.2
C1511	4030016790	S.CER ECJ0EB1C103K	B	86.4/56.2
C1512	4030017780	S.CER ECJ0EB1E472K	B	77/41.6
C1513	4030018900	S.CER ECJ0EB0J474K	B	73.6/55.1
C1514	4030017780	S.CER ECJ0EB1E472K	B	73.5/42.1
C1515	4030018960	S.CER C3216 JB 1C 106MT-N	B	68.3/53.7
C1516	4030017330	S.CER ECJ0EF1C104Z	B	77.3/49
C1517	4030017730	S.CER ECJ0EB1E471K	B	73.4/53.9
C1518	4030016790	S.CER ECJ0EB1C103K	B	85.7/51.4
C1519	4030018960	S.CER C3216 JB 1C 106MT-N	B	69.3/47.4
C1520	4510008630	S.ELE 16 CE 47 FE	B	91/45.4
C1521	4030017680	S.CER ECJ0EC1H820J	B	85.9/58
C1522	4030017670	S.CER ECJ0EC1H390J	T	73.2/55.3
C1523	4030017330	S.CER ECJ0EF1C104Z	T	31.2/80.4
C1524	4030017420	S.CER ECJ0EC1H470J	[EUR] B	73.6/60.5
	4030017420	S.CER ECJ0EC1H470J	[FRA]	
	4030017420	S.CER ECJ0EC1H470J	[ESP]	
	4030017510	S.CER ECJ0EC1H680J	[USA]	
	4030017420	S.CER ECJ0EC1H470J	[EXP]	
	4030017420	S.CER ECJ0EC1H470J	[ITR]	
	4030017420	S.CER ECJ0EC1H470J	[UK]	
	4030017510	S.CER ECJ0EC1H680J	[KOR]	
	4030017420	S.CER ECJ0EC1H470J	[AUS]	
	4030017420	S.CER ECJ0EC1H470J	[CHN]	
C1525	4030018900	S.CER ECJ0EB0J474K	B	85.8/59.9
C1526	4030018960	S.CER C3216 JB 1C 106MT-N	B	69.3/51.5
C1531	4030017490	S.CER C1608 JB 1A 105K-T	B	82.8/48.3
C1532	4030017780	S.CER ECJ0EB1E472K	B	81.9/41.3
C1533	4030017780	S.CER ECJ0EB1E472K	B	81.9/39.4
C1534	4030017780	S.CER ECJ0EB1E472K	B	83.5/38.5
C1601	4030017780	S.CER ECJ0EB1E472K	T	6.3/52.2
C1604	4030017780	S.CER ECJ0EB1E472K	T	5.6/50.8
C1605	4030017330	S.CER ECJ0EF1C104Z	T	8.8/48.7
C1607	4030017780	S.CER ECJ0EB1E472K	T	14.7/46
C1609	4030017490	S.CER C1608 JB 1A 105K-T	T	14.1/33.6
C1610	4030017330	S.CER ECJ0EF1C104Z	T	12.1/44.7
C1611	4030017330	S.CER ECJ0EF1C104Z	T	14.6/41.1
C1613	4030017330	S.CER ECJ0EF1C104Z	T	18.9/47.1
C1614	4030017730	S.CER ECJ0EB1E471K	T	15/36.1
C1615	4030017420	S.CER ECJ0EC1H470J	T	10.4/46.9
C1616	4550007260	S.TAN F931C475MAAABMA	T	9.6/50.5
C1618	4030017430	S.CER ECJ0EC1H101J	T	12.7/26.3
C1701	4030017490	S.CER C1608 JB 1A 105K-T	B	55.1/50.4
C1702	4030017490	S.CER C1608 JB 1A 105K-T	B	55/69.6
C1801	4030017330	S.CER ECJ0EF1C104Z	B	18.4/105
C1802	4510008630	S.ELE 16 CE 47 FE	B	14.4/101.2
C1803	4030018960	S.CER C3216 JB 1C 106MT-N	B	22.3/11.2
C1804	4030017330	S.CER ECJ0EF1C104Z	B	22.8/110.6
C1901	4030017330	S.CER ECJ0EF1C104Z	T	36.2/80.4
C1902	4030017330	S.CER ECJ0EF1C104Z	T	33.7/80.4
C1903	4030017330	S.CER ECJ0EF1C104Z	B	23.3/18.8
C1904	4030017330	S.CER ECJ0EF1C104Z	B	32.5/89.8
C1905	4030017330	S.CER ECJ0EF1C104Z	B	25.9/33.8
C1906	4030017330	S.CER ECJ0EF1C104Z	B	25.9/32.9
C1907	4030017330	S.CER ECJ0EF1C104Z	T	41.6/80.3
C1908	4030017330	S.CER ECJ0EF1C104Z	T	38.4/80.7
C1909	4030017330	S.CER ECJ0EF1C104Z	B	21.6/13.9
C1910	4030017460	S.CER ECJ0EB1E102K	B	45.4/25.4
C1916	4030018960	S.CER C3216 JB 1C 106MT-N	B	14.7/50.5
C1917	4030018960	S.CER C3216 JB 1C 106MT-N	B	5.3/52.7
C1951	4030018960	S.CER C3216 JB 1C 106MT-N	B	48.1/103.1
C1952	4030018960	S.CER C3216 JB 1C 106MT-N	B	48.1/98.9
C1953	4030018960	S.CER C3216 JB 1C 106MT-N	B	48.1/96.8
C1954	4030018960	S.CER C3216 JB 1C 106MT-N	B	48.6/105.2
C1955	4030018960	S.CER C3216 JB 1C 106MT-N	B	48.1/101
C1956	4030018960	S.CER C3216 JB 1C 106MT-N	B	60.9/118.7
C1957	4030017330	S.CER ECJ0EF1C104Z	B	63.8/116.7
C1958	4030018910	S.CER C1608 JB 0J 475K-T	B	20.9/125.7
C1959	4550007390	S.TAN TEESVA 1A 226M8R	B	11.6/120.2
C1960	4030010210	S.CER C3216 JB 1C 105M-T	B	47.3/109.7
C1961	4030017730	S.CER ECJ0EB1E471K	B	44/110
C1962	4030017440	S.CER ECJ0EC1H221J	B	44.6/108.4
C1963	4030017500	S.CER ECJ0EC1H560J	B	35.3/105.1
C1964	4030017330	S.CER ECJ0EF1C104Z	B	44.3/111.3
C1965	4030018960	S.CER C3216 JB 1C 106MT-N	B	7.4/108
C1966	4030017330	S.CER ECJ0EF1C104Z	B	10.1/103
C1968	4030018960	S.CER C3216 JB 1C 106MT-N	B	31.7/103.6
C1969	4030018970	S.CER C3225 JB 1C 226MT-N	B	30.8/100.9
C1970	4030018970	S.CER C3225 JB 1C 226MT-N	B	30.8/97.9
C1971	4030017330	S.CER ECJ0EF1C104Z	B	45.9/111.3
C1972	4030017330	S.CER ECJ0EF1C104Z	B	47.6/106.7
C1973	4030017330	S.CER ECJ0EF1C104Z	B	32.1/105.1
C2001	4030017780	S.CER ECJ0EB1E472K	T	33.2/10.3
C2002	4030017330	S.CER ECJ0EF1C104Z	B	71.7/14.6
C2003	4030017780	S.CER ECJ0EB1E472K	B	58.8/15.8
C2004	4030017780	S.CER ECJ0EB1E472K	B	83/5.9
C2005	4030017780	S.CER ECJ0EB1E472K	B	69/16.4
C2006	4030017330	S.CER ECJ0EF1C104Z	B	83/6.8
C2007	4030017780	S.CER ECJ0EB1E472K	B	84.6/5.9
C2008	4030017330	S.CER ECJ0EF1C104Z	B	56.7/10.1
C2009	4030017330	S.CER ECJ0EF1C104Z	B	75.4/18.6
C2010	4030017780	S.CER ECJ0EB1E472K	B	

[MAIN UNIT]

REF NO.	PARTS NO.	DESCRIPTION	M.	H/V LOCATION
C2012	4030017780	S.CER ECJ0EB1E472K	B	63.1/15.5
C2013	4030017330	S.CER ECJ0EF1C104Z	B	88.9/2
C2014	4030017780	S.CER ECJ0EB1E472K	B	32.5/11.8
C2015	4030017780	S.CER ECJ0EB1E472K	B	32.5/12.7
C2016	4030017780	S.CER ECJ0EB1E472K	B	19/131.2
C2017	4030017330	S.CER ECJ0EF1C104Z	T	86.4/10.2
C2018	4030017780	S.CER ECJ0EB1E472K	B	42.7/17.7
C2019	4030017780	S.CER ECJ0EB1E472K	T	24.7/126.7
C2020	4030017330	S.CER ECJ0EF1C104Z	B	84.1/23.1
C2021	4030017780	S.CER ECJ0EB1E472K	B	32.5/16
C2022	4030017780	S.CER ECJ0EB1E472K	B	30.3/130.2
C2024	4030017780	S.CER ECJ0EB1E472K	B	28.7/128.2
C2025	4030017780	S.CER ECJ0EB1E472K	B	45/12.5
C2026	4030018960	S.CER C3216 JB 1C 106MT-N	B	10.1/23.4
C2027	4030018960	S.CER C3216 JB 1C 106MT-N	B	10.1/14.6
C2028	4030017330	S.CER ECJ0EF1C104Z	B	51.7/12.7
C2029	4030017330	S.CER ECJ0EF1C104Z	B	58.1/9.4
C2030	4030017330	S.CER ECJ0EF1C104Z	B	55.8/15.8
C2032	4030017780	S.CER ECJ0EB1E472K	B	27.4/129
C2033	4030017330	S.CER ECJ0EF1C104Z	B	71.1/21.9
C2034	4030017780	S.CER ECJ0EB1E472K	B	64.8/5.6
C2035	4030017780	S.CER ECJ0EB1E472K	B	25.6/130.2
C2036	4030017330	S.CER ECJ0EF1C104Z	B	88.2/8
C2037	4030017330	S.CER ECJ0EF1C104Z	B	76.4/16.5
C2038	4030017780	S.CER ECJ0EB1E472K	T	14.5/126.4
C2039	4030017780	S.CER ECJ0EB1E472K	B	80.2/6.7
C2040	4030017780	S.CER ECJ0EB1E472K	B	64.6/17.7
C2041	4030017330	S.CER ECJ0EF1C104Z	B	75.2/10.5
C2042	4030017330	S.CER ECJ0EF1C104Z	B	62.7/18.1
C2043	4030017780	S.CER ECJ0EB1E472K	B	55.4/8.8
C2044	4030017780	S.CER ECJ0EB1E472K	B	62.7/19.5
C2045	4030017780	S.CER ECJ0EB1E472K	B	64.3/21.8
C2046	4030017780	S.CER ECJ0EB1E472K	B	63.6/14.6
C2047	4030017780	S.CER ECJ0EB1E472K	B	57.7/21.9
C2048	4030017780	S.CER ECJ0EB1E472K	B	63.1/5.6
C2049	4030017780	S.CER ECJ0EB1E472K	T	45.1/101.8
C2050	4030017780	S.CER ECJ0EB1E472K	T	42.8/100.3
C2051	4030017330	S.CER ECJ0EF1C104Z	T	56.3/99.9
C2052	4030017780	S.CER ECJ0EB1E472K	T	21.6/108
C2053	4030017780	S.CER ECJ0EB1E472K	T	49.8/107.5
C2054	4030018960	S.CER C3216 JB 1C 106MT-N	B	55.3/83.4
C2055	4030018960	S.CER C3216 JB 1C 106MT-N	B	28.1/88.5
C2058	4030018960	S.CER C3216 JB 1C 106MT-N	B	16.4/95.5
C2062	4550007710	S.TAN TEESVB2 1A 476M8R	B	26.6/13
C2063	4030017730	S.CER ECJ0EB1E471K	B	46/13.7
C2064	4030018960	S.CER C3216 JB 1C 106MT-N	B	61.1/23.2
C2065	4030016930	S.CER ECJ0EB1A104K	B	73.3/1.2
C2066	4030016930	S.CER ECJ0EB1A104K	B	75.1/1.2
C2067	4030017430	S.CER ECJ0EC1H101J	B	56.9/19.9
C2068	4030017460	S.CER ECJ0EB1E102K	B	59.1/26.1
C2069	4030017730	S.CER ECJ0EB1E471K	B	46.6/12.1
C2101	4030017330	S.CER ECJ0EF1C104Z	T	28.3/113.8
C2102	4030017330	S.CER ECJ0EF1C104Z	T	44.7/110.9
C2103	4030018960	S.CER C3216 JB 1C 106MT-N	T	28.8/12.2
C2104	4030017330	S.CER ECJ0EF1C104Z	T	56.1/123.5
C2105	4030018960	S.CER C3216 JB 1C 106MT-N	T	54.7/125
C2156	4030017330	S.CER ECJ0EF1C104Z	T	36.2/122.1
C2157	4030017330	S.CER ECJ0EF1C104Z	B	34.4/91
C2158	4030017330	S.CER ECJ0EF1C104Z	B	27.4/93.7
C2159	4030017330	S.CER ECJ0EF1C104Z	T	22.4/94.4
C2160	4030017330	S.CER ECJ0EF1C104Z	B	38.2/88.8
C2161	4030018960	S.CER C3216 JB 1C 106MT-N	T	36.8/123.6
C2162	4030018960	S.CER C3216 JB 1C 106MT-N	B	37.7/90.4
C2163	4030017780	S.CER ECJ0EB1E472K	T	4.6/116.5
C2164	4030018960	S.CER C3216 JB 1C 106MT-N	T	6.5/114.9
C2166	4030012610	S.CER C2012 JB 1C 474K-T	T	5.2/106.8
C2167	4030018960	S.CER C3216 JB 1C 106MT-N	T	4.9/109.9
C2168	4030012610	S.CER C2012 JB 1C 474K-T	T	16.5/116.8
C2169	4030016930	S.CER ECJ0EB1A104K	T	14/124.2
C2201	4030017780	S.CER ECJ0EB1E472K	T	24.7/125.8
C2203	4030018520	S.CER C1608 JB 0J 225M-T	T	16/118.4
C2204	4030017330	S.CER ECJ0EF1C104Z	T	11.1/117.7
C2205	4030018960	S.CER C3216 JB 1C 106MT-N	T	12.4/117.1
C2206	4030017780	S.CER ECJ0EB1E472K	T	21.7/115.6
C2208	4030017730	S.CER ECJ0EB1E471K	T	19/116.9
C2211	4030018960	S.CER C3216 JB 1C 106MT-N	T	22.4/119.9
C2212	4030018960	S.CER C3216 JB 1C 106MT-N	T	23.2/124.3
C2213	4550007140	S.TAN TEESVD 1C 107M12R	T	37.6/138.5
C2214	4030018910	S.CER C1608 JB 0J 475K-T	T	20.9/122.6
C2231	4030017330	S.CER ECJ0EF1C104Z	T	38.2/105.6
C2232	4030018960	S.CER C3216 JB 1C 106MT-N	T	38.1/104
C2233	4030017780	S.CER ECJ0EB1E472K	T	4.7/123.2
C2234	4550007310	S.TAN F930J227MNM BMA	T	70.1/130.6
C2235	4030018960	S.CER C3216 JB 1C 106MT-N	T	40.9/108.8
C2236	4030018960	S.CER C3216 JB 1C 106MT-N	T	39.8/111.1
C2237	4030017460	S.CER ECJ0EB1E102K	T	60.6/123.3
C2254	4030017330	S.CER ECJ0EF1C104Z	T	7.6/92.5
C2255	4030017330	S.CER ECJ0EF1C104Z	B	2.4/98.1
C2256	4030017330	S.CER ECJ0EF1C104Z	B	2.6/95.6
C2257	4030017330	S.CER ECJ0EF1C104Z	T	9.9/87.9
C2260	4030017330	S.CER ECJ0EF1C104Z	T	18.5/103.6
C2261	4030017330	S.CER ECJ0EF1C104Z	T	6.7/104.4
C2262	4030017330	S.CER ECJ0EF1C104Z	T	58.5/100.3
C2264	4030017330	S.CER ECJ0EF1C104Z	T	61.8/88.9
C2266	4030017330	S.CER ECJ0EF1C104Z	T	72/85.2
C2268	4030017330	S.CER ECJ0EF1C104Z	T	68.5/89.4
C2269	4030017330	S.CER ECJ0EF1C104Z	B	78.4/92.4

[MAIN UNIT]

REF NO.	PARTS NO.	DESCRIPTION	M.	H/V LOCATION
C2270	4030017780	S.CER ECJ0EB1E472K	T	61.8/89.8
C2272	4030017330	S.CER ECJ0EF1C104Z	T	56.2/92.2
C2274	4030017330	S.CER ECJ0EF1C104Z	T	55.8/95
C2275	4030017330	S.CER ECJ0EF1C104Z	B	68.1/99.3
C2276	4030017330	S.CER ECJ0EF1C104Z	B	64.2/100.6
C2277	4030017330	S.CER ECJ0EF1C104Z	B	63.6/103.4
C2278	4030017330	S.CER ECJ0EF1C104Z	T	63.6/107.9
C2279	4030017330	S.CER ECJ0EF1C104Z	T	62.7/108.8
C2280	4030017420	S.CER ECJ0EC1H470J	T	51.8/37.9
C2281	4030017330	S.CER ECJ0EF1C104Z	T	68.5/90.3
C2282	4030017330	S.CER ECJ0EF1C104Z	B	80.4/93
C2283	4030017330	S.CER ECJ0EF1C104Z	B	81.6/92.1
C2285	4030017330	S.CER ECJ0EF1C104Z	T	50.8/99
C2286	4030017330	S.CER ECJ0EF1C104Z	T	14.1/88.8
C2301	4030018910	S.CER C1608 JB 0J 475K-T	T	30.8/106.9
C2302	4030018910	S.CER C1608 JB 0J 475K-T	T	27.8/109.4
C2303	4550007310	S.TAN F930J227MNM BMA	T	84.1/110.3
C2311	4030017330	S.CER ECJ0EF1C104Z	B	68.1/110.2
C2312	4030018910	S.CER C1608 JB 0J 475K-T	B	67.3/104.9
C2401	4030017330	S.CER ECJ0EF1C104Z	B	90.8/103.8
C2402	4030017330	S.CER ECJ0EF1C104Z	B	81.2/100.7
C2403	4030017780	S.CER ECJ0EB1E472K	B	77.2/28.8
C2405	4030017330	S.CER ECJ0EF1C104Z	T	74.2/79.3
C2406	4030017460	S.CER ECJ0EB1E102K	B	88.5/99.7
C2407	4030017330	S.CER ECJ0EF1C104Z	T	74.1/78.2
C2408	4030017330	S.CER ECJ0EF1C104Z	B	84.9/96.1
C2409	4030017330	S.CER ECJ0EF1C104Z	T	75.6/77.6
C2410	4030017330	S.CER ECJ0EF1C104Z	B	88.5/85.8
C2411	4030017330	S.CER ECJ0EF1C104Z	B	81.1/96.4
C2412	4510008630	S.ELE 16 CE 47 FE	B	62.1/30.4
C2413	4030017330	S.CER ECJ0EF1C104Z	B	88.5/93.7
C2414	4030017780	S.CER ECJ0EB1E472K	B	84/95.6
C2415	4030017780	S.CER ECJ0EB1E472K	B	88.3/28
C2417	4030017330	S.CER ECJ0EF1C104Z	B	88.3/27.1
C2418	4030017330	S.CER ECJ0EF1C104Z	B	82.6/94
C2419	4030017330	S.CER ECJ0EF1C104Z	B	88.5/86.7
C2422	4030017330	S.CER ECJ0EF1C104Z	T	84.8/87.3
C2423	4030017420	S.CER ECJ0EC1H470J	B	62.1/141.2
C2424	4510008630	S.ELE 16 CE 47 FE	B	69.2/31.3
C2426	4030017330	S.CER ECJ0EF1C104Z	B	68.8/82.1
C2427	4030012600	S.CER C2012 JB 1A 105M-T	T	85.1/91.4
C2501	4030017330	S.CER ECJ0EF1C104Z	B	8/94.2
C2502	4030018960	S.CER C3216 JB 1C 106MT-N	B	11.5/95.2
C2503	4030016970	S.CER ECJ0EB1C223K	B	14.9/89.3
C2505	4030016940	S.CER ECJ0EB1A393K	B	17.4/91.4
C2506	4030017780	S.CER ECJ0EB1E472K	B	18.2/93.8
C2507	4030017490	S.CER C1608 JB 1A 105K-T	B	12.7/89.2
C2551	4030017330	S.CER ECJ0EF1C104Z	B	42.9/124.1
C2552	4030018960	S.CER C3216 JB 1C 106MT-N	B	47.8/118.8
C2553	4030016970	S.CER ECJ0EB1C223K	B	51.3/124.7
C2554	4030018390	S.CER ECJ0EB1A563K	B	53.9/121.9
C2555	4030017760	S.CER ECJ0EB1H222K	B	53.9/121
C2556	4030017770	S.CER ECJ0EB1E332K	B	52.8/123.8
C2557	4030017330	S.CER ECJ0EF1C104Z	B	41.7/120.8
C2558	4030018960	S.CER C3216 JB 1C 106MT-N	B	42.9/118.4
C2561	4030018960	S.CER C3216 JB 1C 106MT-N	B	56.5/124.3
C2562	4030018960	S.CER C3216 JB 1C 106MT-N	B	53.4/126.4
C2563	4550007110	S.TAN SY6-1A107M-RC	B	75.3/122.8
C2564	4030018080	S.CER ECJ0EB1H182K	B	47.8/125.6
C2565	4030017430	S.CER ECJ0EC1H101J	B	44.6/122.6
C2566	4030018090	S.CER ECJ0EB1C822K	B	46.2/124.3
C2601	4030017330	S.CER ECJ0EF1C104Z	B	59.7/125.1
C2603	4030010210	S.CER C3216 JB 1C 105M-T	B	87.5/126
C2604	4030016970	S.CER ECJ0EB1C223K	B	89.1/128.6
C2605	4030017330	S.CER ECJ0EF1C104Z	B	83.9/133.7
C2606	4510009250	S.ELE EEEFK1C471P	T	69.2/137.4
C2607	4510008650	S.ELE EEEFK1C221P	T	58.5/138.3
C2608	4030017330	S.CER ECJ0EF1C104Z	B	87.5/128.6
C2610	4510009250	S.ELE EEEFK1C471P	T	6.2/65.3
C2612	4030017330	S.CER ECJ0EF1C104Z	B	33.9/123.9
C2613	4510009250	S.ELE EEEFK1C471P	T	31.7/131.5
C2616	4030017780	S.CER ECJ0EB1E472K	B	31.6/134.3
C2617	4030017780	S.CER ECJ0EB1E472K	T	33.5/126
C2618	4030017430	S.CER ECJ0EC1H101J	B	31.6/133.4
C2619	4030017780	S.CER ECJ0EB1E472K	T	67.7/112.6
C2620	4510008630	S.ELE 16 CE 47 FE	B	82.9/119.1
C2621	4510008500	S.ELE EEE1CA101WP	T	49.2/138.3
C2622	4510008500	S.ELE EEE1CA101WP	T	60.1/130.4
C2624	4030017330	S.CER ECJ0EF1C104Z	B	38.4/124.5
CP1601	6910009670	S.CHE HK3-S-T	T	11.7/54.7
J1	6510007020	CON TMP-J01X-V6		
J101	6510007020	CON TMP-J01X-V6		
J401	6510007020	CON TMP-J01X-V6		
J801	6510007020	CON TMP-J01X-V6		
J2002	6510019971	S.CON 52808-1071	T	39/12.6
J2003	6510024861	S.CON 5406721-2	T	18.7/137.8
J2004	6510023511	S.CON 28FLT-SM2-TB(LF)(SN)	T	82.4/4.9
J2005				

[MAIN UNIT]

REF NO.	PARTS NO.	DESCRIPTION	M.	H/V LOCATION
J2403	6510019371	S.CON B3B-ZR-SM4-TF(LF)(SN)	T	94.8/1.8
J2405	6510024880	S.CON 52689-3087	T	90.3/93.8
J2406	6510024880	S.CON 52689-3087	T	90.3/70.9
J2407	6510025770	S.CON 03-935H0-72BKA	B	68.4/136.6
J2601	6510014961	S.CON B2B-ZR-SM4-TF(LF)(SN)	T	42.6/128.8
J2602	6510025770	S.CON 03-935H0-72BKA	B	36.3/136.6
W1	9029701008	WIR 72/98/020/X98/X98		
W601	9029701008	WIR 72/98/020/X98/X98		
EP104	6910012350	S.BEA MMZ1608Y 102BT	T	61.2/28.2
EP511	6910012350	S.BEA MMZ1608Y 102BT	T	44.1/26.5
EP1951	6910014730	S.BEA MPZ2012S331A-T	B	61.3/116.7
EP1952	6910014730	S.BEA MPZ2012S331A-T	B	26.8/113.3
EP1953	6910014730	S.BEA MPZ2012S331A-T	B	9.9/104.5
EP1954	6910014730	S.BEA MPZ2012S331A-T	B	50.3/107.3
EP2001	6910012350	S.BEA MMZ1608Y 102BT	B	74.2/5.3
EP2002	6910012350	S.BEA MMZ1608Y 102BT	B	34.7/12.6
EP2003	6910012350	S.BEA MMZ1608Y 102BT	B	33.5/13.8
EP2004	6910012350	S.BEA MMZ1608Y 102BT	B	39.5/15.9
EP2006	6910014730	S.BEA MPZ2012S331A-T	B	42.2/13.3
EP2007	6910012350	S.BEA MMZ1608Y 102BT	B	45.2/11
EP2008	6910012350	S.BEA MMZ1608Y 102BT	B	45.1/14.8
EP2231	6910012350	S.BEA MMZ1608Y 102BT	T	59.8/125.7
EP2251	6910012350	S.BEA MMZ1608Y 102BT	T	4.5/95.5
EP2252	6910012350	S.BEA MMZ1608Y 102BT	T	7.5/95.8
EP2253	6910012350	S.BEA MMZ1608Y 102BT	T	66.1/109.3
EP2254	6910012350	S.BEA MMZ1608Y 102BT	T	65.7/108.1
EP2255	6910012350	S.BEA MMZ1608Y 102BT	T	17.8/101.5
EP2256	6910012350	S.BEA MMZ1608Y 102BT	T	65.1/106
EP2257	6910012350	S.BEA MMZ1608Y 102BT	T	65.1/104.8
EP2258	6910012350	S.BEA MMZ1608Y 102BT	B	77.9/93.4
EP2259	6910012350	S.BEA MMZ1608Y 102BT	B	68.1/102.5
EP2260	6910012350	S.BEA MMZ1608Y 102BT	B	68.1/101.3
EP2261	6910012350	S.BEA MMZ1608Y 102BT	B	66/98.2
EP2262	6910012350	S.BEA MMZ1608Y 102BT	T	69.9/85.5
EP2263	6910014730	S.BEA MPZ2012S331A-T	T	6.5/93.9
EP2264	6910012350	S.BEA MMZ1608Y 102BT	B	69.3/111.3
EP2265	6910012350	S.BEA MMZ1608Y 102BT	B	68.6/98.2
EP2266	6910012350	S.BEA MMZ1608Y 102BT	T	56.2/93.3
EP2271	6910012350	S.BEA MMZ1608Y 102BT	T	74.6/91.1
EP2402	6910012350	S.BEA MMZ1608Y 102BT	B	51.1/129.6
EP2403	6910012350	S.BEA MMZ1608Y 102BT	B	48.4/129.6
EP2404	6910012350	S.BEA MMZ1608Y 102BT	B	68.5/129.3
EP2405	6910012350	S.BEA MMZ1608Y 102BT	B	62.1/134.9
EP2408	6910012350	S.BEA MMZ1608Y 102BT	B	91.3/102.7
EP2409	6910012350	S.BEA MMZ1608Y 102BT	T	85.3/101.2
EP2410	6910012350	S.BEA MMZ1608Y 102BT	T	84.7/98.3
EP2411	6910012350	S.BEA MMZ1608Y 102BT	T	85.2/79.2
EP2412	6910012350	S.BEA MMZ1608Y 102BT	T	82.5/78.4
EP2413	6910012350	S.BEA MMZ1608Y 102BT	B	72.4/129.3
EP2414	6910012350	S.BEA MMZ1608Y 102BT	B	89.3/91
EP2415	6910012350	S.BEA MMZ1608Y 102BT	T	84.9/100
EP2416	6910012350	S.BEA MMZ1608Y 102BT	T	80/77.6
EP2417	6910012350	S.BEA MMZ1608Y 102BT	B	87.2/78.8
EP2602	6910014730	S.BEA MPZ2012S331A-T	T	35.9/125.6
EP2604	6910014730	S.BEA MPZ2012S331A-T	B	31.6/135.7
EP2605	6910014730	S.BEA MPZ2012S331A-T	T	42.9/135.4
EP2606	6910014730	S.BEA MPZ2012S331A-T	T	41.3/133.7
MP201	8510017210	PLA 2427 B-SHIELD PLATE Y801	B	23.1/59.8

[PA UNIT]

REF NO.	PARTS NO.	DESCRIPTION	M.	H/V LOCATION
W101	8970024640	CBL 1.5D175MM C24/C31		
W401	8970024650	CBL 1.5D 200MM(SX2427 A5-6G1)		
IC471	1110005630	S.IC UPC3215TB-E3-A	B	67.6/96.4
IC701	1180002010	S.REG BA08FP-E2	B	126.3/41.9
IC960	1110002700	S.IC NJM2904M-TE1-#FMZB	B	41/132.1
IC981	1130012720	S.IC CD74HC4094PWR	T	26.2/5.9
Q101	1560001091	S.FET 2SK2854(T2LICOM,F)	T	149.2/28.5
Q102	1560001241	S.FET RD01MUS1-T113	T	146/40.1
Q301	1560001391	FET RD70HHF1-101		
Q302	1560001391	FET RD70HHF1-101		
Q401	1560001401	FET RD60HUF1-101		
Q402	1590000680	S.TRA DTC114EUA T106	B	87.7/132.8
Q403	1590000680	S.TRA DTC114EUA T106	B	90/130.3
Q451	1580000691	S.FET 3SK291(TE85R,F)	B	76.7/108.3
Q452	1590003940	S.TRA RN1105(TE85L,F)	B	67.5/115.8
Q453	1590003940	S.TRA RN1105(TE85L,F)	B	75.1/119.8
Q501	1560001591	FET RD70HVF1C-121		
Q502	1590000680	S.TRA DTC114EUA T106	T	87.7/107.5
Q503	1590000680	S.TRA DTC114EUA T106	T	87.7/110
Q551	1580000691	S.FET 3SK291(TE85R,F)	T	68.4/108.9
Q552	1590003940	S.TRA RN1105(TE85L,F)	T	63/110.1
Q700	1590003940	S.TRA RN1105(TE85L,F)	B	126.4/25
Q741	1590003940	S.TRA RN1105(TE85L,F)	B	79.4/9
Q742	1520000460	S.TRA 2SB1132 T100 R	B	83.6/8.2
Q980	1590003940	S.TRA RN1105(TE85L,F)	T	51.3/84.6
Q981	1590003940	S.TRA RN1105(TE85L,F)	T	51.5/139.8
Q982	1590003940	S.TRA RN1105(TE85L,F)	T	53.8/97.3
Q983	1590003940	S.TRA RN1105(TE85L,F)	T	51.2/56.9
Q984	1590003940	S.TRA RN1105(TE85L,F)	T	51.6/97.2
Q985	1590003940	S.TRA RN1105(TE85L,F)	T	51.3/27.9
Q986	1590003940	S.TRA RN1105(TE85L,F)	T	51.3/71.4
Q987	1590003940	S.TRA RN1105(TE85L,F)	T	52.5/41.6
Q988	1590003930	S.TRA UMD22N TR	T	58.2/90.2
D101	1750000301	S.DIO 1SS302(TE85R,F)	T	152.4/22.7
D102	1750000301	S.DIO 1SS302(TE85R,F)	T	152.4/19.8
D151	1750000581	S.DIO 1SV307(TPH3,F)	T	59.5/56.4
D152	1790001250	S.DIO MA2S111-(TX)	T	56.3/58.5
D301	1160000060	S.DIO DAN202U T106	T	105.1/80.8
D302	1160000060	S.DIO DAN202U T106	T	74.9/87.3
D401	1790001240	S.DIO MA2S728-(TX)	B	128/133.6
D402	1790001240	S.DIO MA2S728-(TX)	B	127.5/139.5
D403	1790001240	S.DIO MA2S728-(TX)	B	123.4/140.5
D404	1790001240	S.DIO MA2S728-(TX)	B	125.6/132.8
D406	1710001061	DIO L407CDB		
D407	1710001061	DIO L407CDB		
D408	1750000511	S.DIO UX9401F-STD/TR	B	97.7/136.4
D409	1750000511	S.DIO UX9401F-STD/TR	B	103.5/133
D410	1750000511	S.DIO UX9401F-STD/TR	B	104.7/130
D411	1790001250	S.DIO MA2S111-(TX)	B	94.2/129.2
D412	1160000070	S.DIO DAN202K T146	B	91.6/127
D451	1750000581	S.DIO 1SV307(TPH3,F)	B	85.5/116.3
D452	1750000581	S.DIO 1SV307(TPH3,F)	B	82.4/116
D453	1720000701	S.VAR 1SV305(TPL3,F)	T	75.5/117.3
D454	1720000701	S.VAR 1SV305(TPL3,F)	T	77.8/116.6
D455	1720000701	S.VAR 1SV305(TPL3,F)	B	75.6/99.1
D456	1720000701	S.VAR 1SV305(TPL3,F)	B	67.3/104.1
D461	1750000581	S.DIO 1SV307(TPH3,F)	B	65/93.5
D462	1750000581	S.DIO 1SV307(TPH3,F)	T	65.6/94.7
D501	1790000970	S.DIO MA729(TX)	B	113.7/123.4
D502	1790000970	S.DIO MA729(TX)	B	116.3/122.8
D503	1790000970	S.DIO MA729(TX)	B	114.5/129.4
D504	1790000970	S.DIO MA729(TX)	B	111/129.4
D506	1710001061	DIO L407CDB		
D507	1750000511	S.DIO UX9401F-STD/TR	B	92.1/117.4
D508	1750000511	S.DIO UX9401F-STD/TR	T	86.9/114.4
D509	1750000511	S.DIO UX9401F-STD/TR	T	81.9/120.3
D510	1710001061	DIO L407CDB		
D511	1750000581	S.DIO 1SV307(TPH3,F)	B	95.3/112.2
D551	1750000581	S.DIO 1SV307(TPH3,F)	T	74/116.7
D552	1750000581	S.DIO 1SV307(TPH3,F)	T	72.2/116.7
D553	1750000610	S.VAR MA2SV0500L	T	67.2/118.5
D554	1750000610	S.VAR MA2SV0500L	T	69.6/117.8
D555	1750000581	S.DIO 1SV307(TPH3,F)	T	66.9/116.7
D556	1720000590	S.VAR MA357(TX)	T	71.6/113.3
D557	1750000581	S.DIO 1SV307(TPH3,F)	T	68.1/104.9
D558	1720000590	S.VAR MA357(TX)	T	72.2/104.3
D559	1750000610	S.VAR MA2SV0500L	T	68.9/102.7
D560	1750000610	S.VAR MA2SV0500L	T	71.7/101.3
D701	1790000700	DIO DSA3A1		
D702	1790000700	DIO DSA3A1		
D703	1160000070	S.DIO DAN202K T146	B	126.5/21.5
D704	1790001240	S.DIO MA2S728-(TX)	B	87.9/113.9
D705	1160000070	S.DIO DAN202K T146	B	137.5/14.2
D706	1790001240	S.DIO MA2S728-(TX)	B	86/113
D801	1750000301	S.DIO 1SS302(TE85R,F)	B	42.7/41.8
D820	1750000301	S.DIO 1SS302(TE85R,F)	B	54.3/94.5
D840	1750000301	S.DIO 1SS302(TE85R,F)	B	43.3/99.8
D860	1750000301	S.DIO 1SS302(TE85R,F)	B	43/86
D880	1750000301	S.DIO 1SS302(TE85R,F)	B	43.3/71.6
D900	1750000301	S.DIO 1SS302(TE85R,F)	B	43.7/56.9
D920	1750000301	S.DIO 1SS302(TE85R,F)	B	42.9/28
D940	1750000301	S.DIO 1SS302(TE85R,F)	B	41.1/14.2

M.=Mounted side (T: Mounted on the Top side, B: Mounted on the Bottom side)
S.=Surface mount

[PA UNIT]

REF NO.	PARTS NO.	DESCRIPTION	M.	H/V LOCATION
D961	1790000491	S.DIO HSM88ASTR-E	B	28.1/130.2
D962	1790000491	S.DIO HSM88ASTR-E	B	28.1/133.7
D964	1750000511	S.DIO UX9401F-STD/TR	B	40.1/43.9
D965	1750000511	S.DIO UX9401F-STD/TR	B	42.8/48
L101	6200005051	S.COI NLV25T-330J	T	151.3/33.6
L102	6200008570	S.COI LQW2BHN6N8D03L	T	152.3/37.3
L103	6180000990	COI LAL 04NA 101K		
L104	6180000990	COI LAL 04NA 101K		
L105	6200003950	S.COI HF50ACC 322513-T	B	135.7/34.1
L107	6200002631	S.COI NLV25T-R10J	T	141/47.9
L108	6200003031	S.COI NLV32T-R47J	B	138/41.7
L151	6200003941	S.COI NLV25T-5R6J	B	64.1/41.1
L152	6200005521	S.COI NLV25T-470J	B	64.8/38
L201	6140004580	S.COI LR-515	T	150.4/52.5
L203	6200010040	S.COI AS100340-10N	T	113.8/79.5
L204	6200010040	S.COI AS100340-10N	T	123.5/69.7
L301	6140003410	COI LR-383		
L302	2040000490	COI EXC-ELDR25C		
L303	6140003590	COI LR-400 (TR10X5X5 6H3)		
L304	6140004570	COI LR-507		
L305	6140004560	COI LR-506		
L404	6200010060	S.COI AS080647-56N	T	141/108.9
L407	6200010170	S.COI AS080447-33N	T	146.6/110.7
L408	2040000490	COI EXC-ELDR25C		
L409	2040000490	COI EXC-ELDR25C		
L410	6200010040	S.COI AS100340-10N	T	126.5/137.8
L411	6200010420	S.COI FHW1210HC 1R0JGT <JJE>	T	118.3/136.7
L412	6200010160	S.COI AS080440-22N	T	104.4/134.4
L413	6200010150	S.COI AS080340-15N	T	88.2/139.5
L414	6200010150	S.COI AS080340-15N	T	81/133.5
L415	6200012960	S.COI 0.45-1.4-4TL 12.1N <COMO>	T	99.2/134
L416	6200013000	S.COI 0.25-1.9-13TL 135N <COMO>	T	93.8/132.1
L417	6200007790	S.COI LQW2BHN15J03L	B	98.3/131.1
L441	6200010040	S.COI AS100340-10N	T	133.4/137.8
L451	6200005621	S.COI ELJRE 4N7ZFA	B	81.5/120.1
L452	6200012660	S.COI 0.30-1.0-4TR 9.1N <COMO>	T	76.7/114.9
L453	6200007230	S.COI LQW2BHN15N03L	B	74/104
L454	6200007230	S.COI LQW2BHN15N03L	B	69.9/102.3
L501	6200010780	S.COI C2520C-1R0G-A	T	117.1/86.6
L502	6200010060	S.COI AS080647-56N	T	118.1/125
L504	6200010780	S.COI C2520C-1R0G-A	T	105.7/123.4
L505	6200010070	S.COI AS080747-68N	T	90.2/118.5
L506	6200010170	S.COI AS080447-33N	T	91.9/124.3
L507	6200012910	S.COI 0.35-1.6-8TL 45.5N <COMO>	T	84.7/118
L508	6200010050	S.COI AS080547-47N	T	81.8/127.7
L509	6200010780	S.COI C2520C-1R0G-A	T	93.2/113.1
L510	6200010050	S.COI AS080547-47N	T	75.5/127.5
L531	6110003980	COI LA-604		
L541	6200010070	S.COI AS080747-68N	T	128.5/129.8
L551	6200007700	S.COI LQW2BHN22N03L	T	76.1/120.8
L552	6200007720	S.COI LQW2BHN33N03L	T	70.8/121.2
L553	6200008090	S.COI LQW2BHN68N03L	T	65.1/121.6
L554	6200003640	S.COI MLF1608E 100K-T	T	64.9/114.8
L555	6200003711	S.COI NLV25T-2R7J	T	65.2/105.4
L556	6200003640	S.COI MLF1608E 100K-T	B	64.9/109.6
L557	6200007760	S.COI LQW2BHN82N03L	T	66.8/100.5
L558	6200007710	S.COI LQW2BHN27N03L	T	69.9/98.3
L560	6200002611	S.COI NLV25T-R47J	T	62.9/97.3
L601	6200010040	S.COI AS100340-10N	T	69.2/127.5
L602	6200010160	S.COI AS080440-22N	T	65.7/132.8
L603	6200010150	S.COI AS080340-15N	T	60.8/133.5
L705	6200003550	S.COI MLF1608A 4R7K-T	B	68.2/10.3
L706	6200011300	S.COI EXCML16A270U	T	91/6.9
L707	6200011300	S.COI EXCML16A270U	T	91/5.6
L801	6200011410	S.COI C2520C-82NG-A	T	55.8/55.5
L802	6200010650	S.COI C2520C-R12G-A (0.12U)	T	58.5/52.1
L803	6200007420	S.COI ELJFC 101K-F	B	50.4/39.8
L820	6200006430	S.COI ELJFC 180K-F	B	52.8/97.3
L821	6140002020	COI LR-229 (T50-10)		
L822	6140003540	COI LR-396		
L823	6200006430	S.COI ELJFC 180K-F	B	2.7/106.8
L840	6200007420	S.COI ELJFC 101K-F	B	49.2/98.5
L841	6140001820	COI LR-218 (T50-10)		
L842	6140001800	COI LR-216 (T50-2)		
L843	6140001800	COI LR-216 (T50-2)		
L844	6200007420	S.COI ELJFC 101K-F	B	2.6/90.7
L860	6200004440	S.COI ELJFC 4R7M-F	B	50.3/83.8
L861	6110003550	COI LA-547 (LA-214A)		
L862	6110003570	COI LA-550		
L863	6110003540	COI LA-548 (LA-215A)		
L864	6200004440	S.COI ELJFC 4R7M-F	B	2.8/74.5
L880	6200007420	S.COI ELJFC 101K-F	B	50.3/69.1
L881	6140002570	COI LR-294 (T50-2)		
L882	6140002580	COI LR-295 (T50-2)		
L883	6200007420	S.COI ELJFC 101K-F	B	2.6/58.4
L900	6200008600	S.COI ELJFC 560K-F	B	50/54.6
L901	6140002560	COI LR-293 (T50-10)		
L902	6140002560	COI LR-293 (T50-10)		
L903	6140002560	COI LR-293 (T50-10)		
L904	6200008600	S.COI ELJFC 560K-F	B	2.6/42.3
L920	6200007420	S.COI ELJFC 101K-F	B	50.4/25.4
L921	6140001780	COI LR-214 (T50-2)		
L922	6140001780	COI LR-214 (T50-2)		
L923	6200007420	S.COI ELJFC 101K-F	B	2.6/26.1
L940	6200007390	S.COI ELJFC 120K-F	B	47.3/9.9

[PA UNIT]

REF NO.	PARTS NO.	DESCRIPTION	M.	H/V LOCATION
L941	6140003450	COI LR-387 (T50-10)		
L942	6140003460	COI LR-388 (T50-10)		
L943	6200007420	S.COI ELJFC 101K-F	B	41.1/11.1
L944	6200007390	S.COI ELJFC 120K-F	B	9/10.5
L960	6200007420	S.COI ELJFC 101K-F	B	45.3/130.6
L961	6140003490	COI LR-391 (TR10X5X5 3A6)		
L980	6200007420	S.COI ELJFC 101K-F	B	30.7/8
L981	6200007420	S.COI ELJFC 101K-F	T	51.7/9
L982	6200007420	S.COI ELJFC 101K-F	T	48.3/2.3
R101	7030003370	S.RES ERJ3GEYJ 271 V (270)	B	150.9/21
R102	7030003230	S.RES ERJ3GEYJ 180 V (18)	B	150.9/22.5
R103	7030003370	S.RES ERJ3GEYJ 271 V (270)	B	151.9/25.2
R104	7030003300	S.RES ERJ3GEYJ 680 V (68)	B	150.8/27.7
R105	7030003420	S.RES ERJ3GEYJ 681 V (680)	T	152.7/29.8
R106	7030003480	S.RES ERJ3GEYJ 222 V (2.2K)	B	147.8/29.7
R107	7030003530	S.RES ERJ3GEYJ 562 V (5.6K)	B	147.8/28.3
R108	7030003400	S.RES ERJ3GEYJ 471 V (470)	T	151.4/31.7
R109	7030008190	S.RES ERJ12YJ330U (33)	B	145.5/32.7
R110	7030000230	S.RES MCR10EZJH 56 (560)	T	149.4/39.8
R111	7030003410	S.RES ERJ3GEYJ 561 V (560)	B	143.8/42.1
R112	7030003510	S.RES ERJ3GEYJ 392 V (3.9K)	B	146.1/37.5
R113	7030003540	S.RES ERJ3GEYJ 682 V (6.8K)	B	146.1/35.7
R116	7030000340	S.RES MCR10EZJH 470 (471)	B	141.3/40.8
R117	7030003860	S.RES ERJ3GE JPW V	T	146.7/47.7
R151	7030003380	S.RES ERJ3GEYJ 331 V (330)	B	61.6/37.8
R152	7030003440	S.RES ERJ3GEYJ 102 V (1K)	B	61.7/60.1
R153	7030003520	S.RES ERJ3GEYJ 472 V (4.7K)	T	59.2/57.9
R201	7030003320	S.RES ERJ3GEYJ 101 V (100)	B	123/49.9
R202	7030003520	S.RES ERJ3GEYJ 472 V (4.7K)	B	136/49.8
R204	7030003440	S.RES ERJ3GEYJ 102 V (1K)	B	138/52.8
R205	7030010420	S.RES ERJ1TYJ 560U (56)	B	145/51.5
R301	7030009300	S.RES ERJ1WY0R00U	B	92.2/84.4
R302	7030010520	S.RES ERJ1TYJ 101U (100)	T	89.4/86.1
R303	7030009300	S.RES ERJ1WY0R00U	B	85.4/84.4
R304	7030003320	S.RES ERJ3GEYJ 101 V (100)	T	107.1/79.8
R305	7030010410	S.RES ERJ1TYJ 220U (22)	T	100.2/84.1
R306	7030003320	S.RES ERJ3GEYJ 101 V (100)	B	71.2/83.3
R307	7030010410	S.RES ERJ1TYJ 220U (22)	T	77.5/84.1
R308	7030003480	S.RES ERJ3GEYJ 222 V (2.2K)	B	99/84.9
R309	7030003480	S.RES ERJ3GEYJ 222 V (2.2K)	B	78.7/84.9
R310	7030007630	S.RES MCR100JZHJ 0.68 (R68)	B	100.1/82.2
R311	7030007630	S.RES MCR100JZHJ 0.68 (R68)	B	78.3/82.1
R312	7030011250	S.RES ERJ1TY 390U (39)	T	100.9/77.7
R313	7030010540	S.RES ERJ1TYJ 330U (33)	T	97.2/77.7
R314	7030010540	S.RES ERJ1TYJ 330U (33)	T	81.6/77.7
R315	7030011250	S.RES ERJ1TY 390U (39)	T	77.9/77.7
R317	7030010950	S.RES ERJ1TYJ 100U (10)	B	104/20.6
R318	7030010950	S.RES ERJ1TYJ 100U (10)	B	99.6/20.6
R319	7030010660	S.RES ERJ1TYJ 6R8U (6.8)	B	89.4/54.5
R402	7030003320	S.RES ERJ3GEYJ 101 V (100)	B	151.7/73.1
R403	7030003520	S.RES ERJ3GEYJ 472 V (4.7K)	T	151.8/71.2
R404	7030000260	S.RES MCR10EZJH 100 (101)	T	149.4/77.6
R405	7030003540	S.RES ERJ3GEYJ 682 V (6.8K)	B	126.7/137.5
R406	7030003860	S.RES ERJ3GE JPW V	B	128.4/136.1
R407	7030003440	S.RES ERJ3GEYJ 102 V (1K)	B	129.7/133.6
R408	7030003860	S.RES ERJ3GE JPW V	B	124.1/137.6
R409	7030003440	S.RES ERJ3GEYJ 102 V (1K)	B	127/130.4
R410	7030003440	S.RES ERJ3GEYJ 102 V (1K)	B	131.6/133
R411	7030003540	S.RES ERJ3GEYJ 682 V (6.8K)	B	125.1/135.5
R412	7030003500	S.RES ERJ3GEYJ 332 V (3.3K)	B	131.1/129.7
R413	7030007160	S.RES ERJ12YJ3R3U (3.3)	B	123.5/126.1
R415	7030008350	S.RES ERJ12YJ390U	B	86.7/135.4
R416	7030000140	S.RES MCR10EZJH 10 (100)	B	93.8/130.7
R417	7030000140	S.RES MCR10EZJH 10 (100)	B	95.5/132.5
R418	7030000010	S.RES MCR10EZJH JPW (000)	B	99.3/133.9
R451	7030003470	S.RES ERJ3GEYJ 182 V (1.8K)	B	81.5/121.7
R452	7030004040	S.RES ERJ3GEYJ 4R7 V (4.7)	B	85.5/119.3
R453	7030003260	S.RES ERJ3GEYJ 330 V (33)	B	81.6/118.4
R454	7030003860	S.RES ERJ3GE JPW V	B	77.3/116
R455	7030003640	S.RES ERJ3GEYJ 473 V (47K)	B	73.2/117.5
R456	7030003700	S.RES ERJ3GEYJ 154 V (150K)	B	72/114.4
R457	7030003750	S.RES ERJ3GEYJ 394 V (390K)	B	71.2/111.9
R458	7030003710	S.RES ERJ3GEYJ 184 V (180K)	B	73.8/112.4
R459	7030003740	S.RES ERJ3GEYJ 334 V (330K)	B	69.6/111.3
R460	7030003740	S.RES ERJ3GEYJ 334 V (330K)	B	76.6/112.1
R461	7030003270	S.RES ERJ3GEYJ 390 V (39)	B	77.7/103.3
R462	7030003680	S.RES ERJ3GEYJ 104 V (100K)	B	72.9/99.6
R463	7030003520	S.RES ERJ3GEYJ 472 V (4.7K)	B	74.4/102.4
R464	7030003210	S.RES ERJ3GEYJ 120 V (12)	B	74.1/105.7
R465	7030003680	S.RES ERJ3GEYJ 104 V (100K)	B	66.5/101.7
R466	7030003860	S.RES ERJ3GE JPW V	B	62.1/100.2
R467	7030003640	S.RES ERJ3GEYJ 473 V (47K)	B	75.1/117.2
R468	7030008240	S.RES ERJ12Y0R00U	B	89.1/121.9
R470	7030003320	S.RES ERJ3GEYJ 101 V (100)	B	67.7/98.8
R471	7030003270	S.RES ERJ3GEYJ 390 V (39)	B	69.6/98.3
R472	7030003340	S.RES ERJ3GEYJ 151 V (150)	B	69.6/99.5
R473	7030003340	S.RES ERJ3GEYJ 151 V (150)	B	69.6/100.7
R474	7030003340	S.RES ERJ3GEYJ 151 V (150)	B	63.5/96.9
R475	7030003340	S.RES ERJ3GEYJ 151 V (150)	B	64.9/96.9
R476	7030003270	S.RES ERJ3GEYJ 390 V (39)	B	64.8/95.1
R477	7030003360	S.RES ERJ3GEYJ 221 V (220)	B	61.8/97.6
R502	7030003320	S.RES ERJ3GEYJ 101 V (100)	T	112.1/87.9
R503				

[PA UNIT]

REF NO.	PARTS NO.	DESCRIPTION	M.	H/V LOCATION
R507	7030003440	S.RES ERJ3GEYJ 102 V (1K)	B	110.2/123.1
R508	7030003520	S.RES ERJ3GEYJ 472 V (4.7K)	B	107.1/121.5
R510	7030003440	S.RES ERJ3GEYJ 102 V (1K)	B	110.3/125.7
R511	7030003540	S.RES ERJ3GEYJ 682 V (6.8K)	B	112.1/133.9
R512	7030003560	S.RES ERJ3GEYJ 103 V (10K)	B	107.1/123.1
R513	7030010520	S.RES ERJ1TYJ 101U (100)	B	103.7/114.2
R515	7030006060	S.RES ERJ12YJ100U (10)	T	92.1/108.9
R516	7030003860	S.RES ERJ3GE JPW V	T	90.6/114.3
R517	7030010520	S.RES ERJ1TYJ 101U (100)	B	103.7/118.4
R518	7030003440	S.RES ERJ3GEYJ 102 V (1K)	B	97.4/112.6
R519	7030000010	S.RES MCR10EZJH JPW (000)	B	111.1/119.1
R551	7030003470	S.RES ERJ3GEYJ 182 V (1.8K)	T	78.2/117.8
R552	7030004040	S.RES ERJ3GEYJ 4R7 V (4.7)	T	76.7/119.1
R553	7030003260	S.RES ERJ3GEYJ 330 V (33)	T	73/118.9
R554	7030003680	S.RES ERJ3GEYJ 104 V (100K)	T	66.8/120.4
R555	7030003440	S.RES ERJ3GEYJ 102 V (1K)	T	68.1/114.7
R556	7030003680	S.RES ERJ3GEYJ 104 V (100K)	T	69.9/116.6
R557	7030003740	S.RES ERJ3GEYJ 334 V (330K)	T	65.7/112.9
R558	7030003710	S.RES ERJ3GEYJ 184 V (180K)	T	70.5/111.2
R559	7030003720	S.RES ERJ3GEYJ 224 V (220K)	T	65.7/111.7
R560	7030003720	S.RES ERJ3GEYJ 224 V (220K)	T	65.6/110.5
R561	7030003740	S.RES ERJ3GEYJ 334 V (330K)	T	68.3/112.4
R562	7030003270	S.RES ERJ3GEYJ 390 V (39)	T	70.1/106.6
R563	7030003420	S.RES ERJ3GEYJ 681 V (680)	T	65.4/107.3
R564	7030003210	S.RES ERJ3GEYJ 120 V (12)	T	63.5/103
R565	7030003440	S.RES ERJ3GEYJ 102 V (1K)	B	65.6/106.3
R567	7030003680	S.RES ERJ3GEYJ 104 V (100K)	T	70.1/104
R568	7030003680	S.RES ERJ3GEYJ 104 V (100K)	T	69.7/100.7
R570	7030003380	S.RES ERJ3GEYJ 331 V (330)	T	62.8/100.3
R575	7030003520	S.RES ERJ3GEYJ 472 V (4.7K)	T	68.4/100.7
R576	7030003540	S.RES ERJ3GEYJ 682 V (6.8K)	T	71.8/100
R577	7030003520	S.RES ERJ3GEYJ 472 V (4.7K)	T	68/120.4
R578	7030003540	S.RES ERJ3GEYJ 682 V (6.8K)	T	69.9/119
R701	7030003500	S.RES ERJ3GEYJ 332 V (3.3K)	B	82.2/16.9
R702	7030003500	S.RES ERJ3GEYJ 332 V (3.3K)	B	83/14.5
R703	7030003500	S.RES ERJ3GEYJ 332 V (3.3K)	B	80.6/16.9
R704	7030003500	S.RES ERJ3GEYJ 332 V (3.3K)	B	79.7/14.5
R705	7030009300	S.RES ERJ1WYOR00U	B	134.6/23.8
R721	7030011240	S.RES LRF3W-LF-01-R020F	B	83/22.3
R722	7030011240	S.RES LRF3W-LF-01-R020F	B	83/29.6
R723	7030004040	S.RES ERJ3GEYJ 4R7 V (4.7)	B	140.5/14.7
R733	7030009591	S.RES ERA3YED 472V (4.7K)	B	138.6/10.4
R734	7510001470	S.THE NTCG20 4AG 473JT	T	111.9/58.2
R735	7030009591	S.RES ERA3YED 472V (4.7K)	B	140.2/12.5
R736	7510001470	S.THE NTCG20 4AG 473JT	T	153.3/77.1
R742	7030003640	S.RES ERJ3GEYJ 473 V (47K)	B	83.4/11.5
R743	7030003440	S.RES ERJ3GEYJ 102 V (1K)	B	80.2/10.9
R744	7030003860	S.RES ERJ3GE JPW V	T	67.8/9.6
R749	7030003860	S.RES ERJ3GE JPW V	B	65/5.2
R750	7030003860	S.RES ERJ3GE JPW V	B	66.6/5.2
R773	7030003860	S.RES ERJ3GE JPW V	T	103.4/9.5
R960	7030003860	S.RES ERJ3GE JPW V	B	43.2/125.7
R961	7030003380	S.RES ERJ3GEYJ 331 V (330)	B	42/138.3
R962	7030003440	S.RES ERJ3GEYJ 102 V (1K)	B	37.4/137.8
R963	7030003440	S.RES ERJ3GEYJ 102 V (1K)	B	40.3/126.3
R964	7030003860	S.RES ERJ3GE JPW V	B	24.8/131.2
R965	7030003640	S.RES ERJ3GEYJ 473 V (47K)	B	32.6/130.5
R966	7030008190	S.RES ERJ12YJ330U (33)	B	11.1/129.6
R967	7030003640	S.RES ERJ3GEYJ 473 V (47K)	B	34.2/130.5
R968	7030003860	S.RES ERJ3GE JPW V	B	24.8/132.8
R969	7030003600	S.RES ERJ3GEYJ 223 V (22K)	B	32.6/133.6
R970	7030003680	S.RES ERJ3GEYJ 104 V (100K)	B	34.2/133.6
R971	7540000130	ABS 2P-50A-301		
R972	7030003620	S.RES ERJ3GEYJ 333 V (33K)	B	17.4/140.1
R973	7030003620	S.RES ERJ3GEYJ 333 V (33K)	B	18.9/138.5
R974	7030003620	S.RES ERJ3GEYJ 333 V (33K)	B	19.4/136.6
R994	7030003560	S.RES ERJ3GEYJ 103 V (10K)	B	22.4/2.6
R995	7030003560	S.RES ERJ3GEYJ 103 V (10K)	B	22.4/6.8
R996	7030003560	S.RES ERJ3GEYJ 103 V (10K)	B	21.6/5.4
R997	7030003560	S.RES ERJ3GEYJ 103 V (10K)	B	21.6/8.2
R998	7030003320	S.RES ERJ3GEYJ 101 V (100)	T	54.1/4.4
R999	7030003320	S.RES ERJ3GEYJ 101 V (100)	T	54.5/3.1
R1000	7030003320	S.RES ERJ3GEYJ 101 V (100)	T	51.2/3.5
R1001	7030003320	S.RES ERJ3GEYJ 101 V (100)	T	49.3/4.9
R1002	7030000280	S.RES MCR10EZJH 150 (151)	T	48/9.7
R1003	7030000290	S.RES MCR10EZJH 180 (181)	T	47.5/7.9
C101	4030011600	S.CER C1608 JB 1E 104K-T	T	151.9/25.1
C102	4030011600	S.CER C1608 JB 1E 104K-T	B	150.8/29.3
C103	4030011340	S.CER C1608 CH 1H 471J-T	T	152.7/27.2
C104	4030011600	S.CER C1608 JB 1E 104K-T	T	147.8/32.2
C105	4510004591	ELE 16 ME 470 HC		
C106	4030011600	S.CER C1608 JB 1E 104K-T	B	142.7/29.2
C107	4030011600	S.CER C1608 JB 1E 104K-T	T	151.6/39.7
C108	4030011600	S.CER C1608 JB 1E 104K-T	T	149.2/36.5
C109	4030007130	S.CER C1608 CH 1H 101J-T	B	146.6/42.1
C112	4030011600	S.CER C1608 JB 1E 104K-T	B	139.2/35.1
C113	4030011600	S.CER C1608 JB 1E 104K-T	T	144.6/44.4
C114	4030011600	S.CER C1608 JB 1E 104K-T	B	134.1/37
C116	4030007060	S.CER C1608 CH 1H 270J-T	T	144.6/45.8
C118	4030007130	S.CER C1608 CH 1H 101J-T	T	143.5/48.5
C119	4030007130	S.CER C1608 CH 1H 101J-T	T	144/50.4
C120	4030007020	S.CER C1608 CH 1H 120J-T	T	143.5/47.2
C122	4510008500	S.ELE EEE1CA101WP	T	121.5/11.2
C151	4030011600	S.CER C1608 JB 1E 104K-T	T	59.2/54.8
C152	4030006880	S.CER C1608 JB 1H 472K-T	B	61.6/36.2

[PA UNIT]

REF NO.	PARTS NO.	DESCRIPTION	M.	H/V LOCATION
C153	4030011600	S.CER C1608 JB 1E 104K-T	B	63.1/56
C154	4030006860	S.CER C1608 JB 1H 102K-T	B	63.1/54.7
C201	4030006860	S.CER C1608 JB 1H 102K-T	T	145.6/53
C202	4030006860	S.CER C1608 JB 1H 102K-T	T	143/53
C204	4030011600	S.CER C1608 JB 1E 104K-T	B	139.3/48.4
C205	4030006860	S.CER C1608 JB 1H 102K-T	B	123.3/48.6
C206	4030017810	S.CER C1608 CH 1H 102J-T	B	133.5/50.6
C207	4030017810	S.CER C1608 CH 1H 102J-T	B	139.3/49.7
C208	4030011600	S.CER C1608 JB 1E 104K-T	B	132/50.6
C209	4030007170	S.CER C1608 CH 1H 221J-T	B	139.3/51
C214	4030018940	S.CER GRM31A7U2J331JW31D	T	116.3/76.1
C215	4030018930	S.CER GRM31A7U2J221JW31D	T	122.2/73.9
C217	4030011600	S.CER C1608 JB 1E 104K-T	T	144.3/53
C218	4030018930	S.CER GRM31A7U2J221JW31D	T	101/88.5
C219	4030018930	S.CER GRM31A7U2J221JW31D	B	82.4/99.7
C251	4030011180	S.CER GRM31M2C2H220JV01L (GRM42-6 CH)	B	134.9/66
C252	4030011180	S.CER GRM31M2C2H220JV01L (GRM42-6 CH)	B	142.2/70.6
C253	4030011080	S.CER GRM31M2C2H6R0DV01L (GRM42-6 CH)	B	145.5/79
C254	4030011160	S.CER GRM31M2C2H150JV01L (GRM42-6 CH)	B	127.7/65.3
C261	4030012480	S.CER GRM31M2C2H121JV01L (GRM42-6 CH)	B	131.7/75.1
C262	4030018940	S.CER GRM31A7U2J331JW31D	B	126/80.1
C263	4030018770	S.CER C3216 CH 2J 102J-T	B	122.1/80.7
C266	4030018950	S.CER GRM31A7U2J681JW31D	B	119.7/80.2
C267	4030018930	S.CER GRM31A7U2J221JW31D	B	124/85.3
C301	4030001100	S.CER GRM216B11H102KA01D (GRM40 B)	B	91.7/100.6
C302	4030001020	S.CER GRM216C1H121JA01D (GRM40 CH)	B	93.8/100.6
C303	4030011600	S.CER C1608 JB 1E 104K-T	B	110.8/85.5
C304	4030017320	S.CER GRM21BB11H104KA01L (GRM40-034)	B	94.8/97.6
C305	4510004591	ELE 16 ME 470 HC		
C306	4030004720	S.CER C2012 JB 1H 102K-T	[EUR] B	83.6/39.8
	4030004720	S.CER C2012 JB 1H 102K-T	[FRA]	
	4030004720	S.CER C2012 JB 1H 102K-T	[ESP]	
	4030004720	S.CER C2012 JB 1H 102K-T	[USA]	
	4030004720	S.CER C2012 JB 1H 102K-T	[EXP]	
	4030004720	S.CER C2012 JB 1H 102K-T	[ITR]	
	4030004720	S.CER C2012 JB 1H 102K-T	[UK]	
	4030004720	S.CER C2012 JB 1H 102K-T	[KOR]	
	4030006860	S.CER C1608 JB 1H 102K-T	[AUS]	
	4030004720	S.CER C2012 JB 1H 102K-T	[CHN]	
C307	4030004720	S.CER C2012 JB 1H 102K-T	[EUR] B	100.6/39.8
	4030004720	S.CER C2012 JB 1H 102K-T	[FRA]	
	4030004720	S.CER C2012 JB 1H 102K-T	[ESP]	
	4030004720	S.CER C2012 JB 1H 102K-T	[USA]	
	4030004720	S.CER C2012 JB 1H 102K-T	[EXP]	
	4030004720	S.CER C2012 JB 1H 102K-T	[ITR]	
	4030004720	S.CER C2012 JB 1H 102K-T	[UK]	
	4030004720	S.CER C2012 JB 1H 102K-T	[KOR]	
	4030006860	S.CER C1608 JB 1H 102K-T	[AUS]	
	4030004720	S.CER C2012 JB 1H 102K-T	[CHN]	
C308	4030004720	S.CER C2012 JB 1H 102K-T	B	91.9/10.9
	4030004720	S.CER C2012 JB 1H 102K-T	[EUR]	
	4030004720	S.CER C2012 JB 1H 102K-T	[FRA]	
	4030004720	S.CER C2012 JB 1H 102K-T	[ESP]	
	4030004720	S.CER C2012 JB 1H 102K-T	[USA]	
	4030004720	S.CER C2012 JB 1H 102K-T	[EXP]	
	4030004720	S.CER C2012 JB 1H 102K-T	[ITR]	
	4030004720	S.CER C2012 JB 1H 102K-T	[UK]	
	4030004720	S.CER C2012 JB 1H 102K-T	[KOR]	
	4030006860	S.CER C1608 JB 1H 102K-T	[AUS]	
	4030004720	S.CER C2012 JB 1H 102K-T	[CHN]	
C309	4030011600	S.CER C1608 JB 1E 104K-T	T	105.8/78.3
C311	4030018750	S.CER C3225 CH 2J 682K-T	B	92.7/78.5
C312	4030018750	S.CER C3225 CH 2J 682K-T	B	84.9/78.5
C313	4030011600	S.CER C1608 JB 1E 104K-T	T	76.8/87.8
C314	4030018750	S.CER C3225 CH 2J 682K-T	B	96.9/77.6
C315	4030018750	S.CER C3225 CH 2J 682K-T	B	80.6/77.6
C319	4030011730	S.CER GRM31M2C2H101JV01L (GRM42-6 CH)	B	110/48.8
C320	4030011730	S.CER GRM31M2C2H101JV01L (GRM42-6 CH)	B	71.1/48.9
C323	4030003810	S.MIC UC342H 1200J-T	B	91.4/46.4
C324	4320001050	S.MIC UC342H 3900J-T	T	94.4/40.2
C325	4320001070	S.MIC UC342H 3300J-T	B	94.4/40.7
C327	4030011790	S.CER GRM55RF52A684ZD01L (GRM44-1)	T	65.9/46.3
C331	4030011600	S.CER C1608 JB 1E 104K-T	T	108.3/78.3
C332	4030011600	S.CER C1608 JB 1E 104K-T	B	69.5/81.4
C333	4030018940	S.CER GRM31A7U2J331JW31D	B	88.4/101.8
C340	4030006860	S.CER C1608 JB 1H 102K-T	B	82.3/107.3
C341	4030006860	S.CER C1608 JB 1H 102K-T	B	92.4/107.4
C342	4030006860	S.CER C1608 JB 1H 102K-T	B	87.1/91.6
C350	4030004720	S.CER C2012 JB 1H 102K-T	[EUR] B	103.4/39.8
	4030004720	S.CER C2012 JB 1H 102K-T	[FRA]	
	4030004720	S.CER C2012 JB 1H 102K-T	[ESP]	
	4030004720	S.CER C2012 JB 1H 102K-T	[USA]	
	4030004720	S.CER C2012 JB 1H 102K-T	[EXP]	
	4030004720	S.CER C2012 JB 1H 102K-T	[ITR]	
	4030004720	S.CER C2012 JB 1H 102K-T	[UK]	
	4030004720	S.CER C2012 JB 1H 102K-T	[KOR]	
	4030004720	S.CER C2012 JB 1H 102K-T	[CHN]	

[PA UNIT]

REF NO.	PARTS NO.	DESCRIPTION	M.	H/V LOCATION
C351	4030004720	S.CER C2012 JB 1H 102K-T [EUR]	B	106.1/39.8
	4030004720	S.CER C2012 JB 1H 102K-T [FRA]		
	4030004720	S.CER C2012 JB 1H 102K-T [ESP]		
	4030004720	S.CER C2012 JB 1H 102K-T [USA]		
C351	4030004720	S.CER C2012 JB 1H 102K-T [EXP]	B	106.1/39.8
	4030004720	S.CER C2012 JB 1H 102K-T [ITR]		
	4030004720	S.CER C2012 JB 1H 102K-T [UK]		
	4030004720	S.CER C2012 JB 1H 102K-T [KOR]		
	4030004720	S.CER C2012 JB 1H 102K-T [CHN]		
C353	4030004720	S.CER C2012 JB 1H 102K-T [EUR]	B	86.3/39.8
	4030004720	S.CER C2012 JB 1H 102K-T [FRA]		
	4030004720	S.CER C2012 JB 1H 102K-T [ESP]		
	4030004720	S.CER C2012 JB 1H 102K-T [USA]		
	4030004720	S.CER C2012 JB 1H 102K-T [EXP]		
	4030004720	S.CER C2012 JB 1H 102K-T [ITR]		
	4030004720	S.CER C2012 JB 1H 102K-T [UK]		
	4030004720	S.CER C2012 JB 1H 102K-T [KOR]		
	4030004720	S.CER C2012 JB 1H 102K-T [CHN]		
C354	4030004720	S.CER C2012 JB 1H 102K-T [EUR]	B	89.1/39.8
	4030004720	S.CER C2012 JB 1H 102K-T [FRA]		
	4030004720	S.CER C2012 JB 1H 102K-T [ESP]		
	4030004720	S.CER C2012 JB 1H 102K-T [USA]		
	4030004720	S.CER C2012 JB 1H 102K-T [EXP]		
	4030004720	S.CER C2012 JB 1H 102K-T [ITR]		
	4030004720	S.CER C2012 JB 1H 102K-T [UK]		
	4030004720	S.CER C2012 JB 1H 102K-T [KOR]		
	4030004720	S.CER C2012 JB 1H 102K-T [CHN]		
C356	4030004720	S.CER C2012 JB 1H 102K-T [EUR]	B	97.5/10.9
	4030004720	S.CER C2012 JB 1H 102K-T [FRA]		
	4030004720	S.CER C2012 JB 1H 102K-T [ESP]		
	4030004720	S.CER C2012 JB 1H 102K-T [USA]		
	4030004720	S.CER C2012 JB 1H 102K-T [EXP]		
	4030004720	S.CER C2012 JB 1H 102K-T [ITR]		
	4030004720	S.CER C2012 JB 1H 102K-T [UK]		
	4030004720	S.CER C2012 JB 1H 102K-T [KOR]		
	4030004720	S.CER C2012 JB 1H 102K-T [CHN]		
C357	4030004720	S.CER C2012 JB 1H 102K-T [EUR]	B	94.7/10.9
	4030004720	S.CER C2012 JB 1H 102K-T [FRA]		
	4030004720	S.CER C2012 JB 1H 102K-T [ESP]		
	4030004720	S.CER C2012 JB 1H 102K-T [USA]		
	4030004720	S.CER C2012 JB 1H 102K-T [EXP]		
	4030004720	S.CER C2012 JB 1H 102K-T [ITR]		
	4030004720	S.CER C2012 JB 1H 102K-T [UK]		
	4030004720	S.CER C2012 JB 1H 102K-T [KOR]		
	4030004720	S.CER C2012 JB 1H 102K-T [CHN]		
C358	4030006860	S.CER C1608 JB 1H 102K-T [EUR]	B	90/91.6
	4030006860	S.CER C1608 JB 1H 102K-T [FRA]		
	4030006860	S.CER C1608 JB 1H 102K-T [ESP]		
	4030006860	S.CER C1608 JB 1H 102K-T [USA]		
	4030006860	S.CER C1608 JB 1H 102K-T [EXP]		
	4030006860	S.CER C1608 JB 1H 102K-T [ITR]		
	4030006860	S.CER C1608 JB 1H 102K-T [UK]		
	4030006860	S.CER C1608 JB 1H 102K-T [KOR]		
	4030006860	S.CER C1608 JB 1H 102K-T [CHN]		
C359	4030006860	S.CER C1608 JB 1H 102K-T [EUR]	B	94.9/107.4
	4030006860	S.CER C1608 JB 1H 102K-T [FRA]		
	4030006860	S.CER C1608 JB 1H 102K-T [ESP]		
	4030006860	S.CER C1608 JB 1H 102K-T [USA]		
	4030006860	S.CER C1608 JB 1H 102K-T [EXP]		
	4030006860	S.CER C1608 JB 1H 102K-T [ITR]		
	4030006860	S.CER C1608 JB 1H 102K-T [UK]		
	4030006860	S.CER C1608 JB 1H 102K-T [KOR]		
	4030006860	S.CER C1608 JB 1H 102K-T [CHN]		
C360	4030006860	S.CER C1608 JB 1H 102K-T [EUR]	B	85/107.3
	4030006860	S.CER C1608 JB 1H 102K-T [FRA]		
	4030006860	S.CER C1608 JB 1H 102K-T [ESP]		
	4030006860	S.CER C1608 JB 1H 102K-T [USA]		
	4030006860	S.CER C1608 JB 1H 102K-T [EXP]		
	4030006860	S.CER C1608 JB 1H 102K-T [ITR]		
	4030006860	S.CER C1608 JB 1H 102K-T [UK]		
	4030006860	S.CER C1608 JB 1H 102K-T [KOR]		
	4030006860	S.CER C1608 JB 1H 102K-T [CHN]		
C403	4030006860	S.CER C1608 JB 1H 102K-T	B	89.6/133.4
C404	4030006860	S.CER C1608 JB 1H 102K-T	B	151.7/71.4
C405	4030011740	S.CER GRM32N2C2H201JV01L (GRM42-2 CH)	T	145.3/105.7
C406	4030006860	S.CER C1608 JB 1H 102K-T	B	132.4/129.7
C408	4030018040	S.CER ERF22X 6C2H 180J D01L	B	134.2/93
C409	4030018040	S.CER ERF22X 6C2H 180J D01L	B	145.4/93
C410	4030018260	S.CER ERF22X 6C2H 150J D01L	B	145.4/96.4
C411	4030018260	S.CER ERF22X 6C2H 150J D01L	B	134.2/96.4
C412	4030018770	S.CER C3216 CH 2J 102J-T	T	136/111.5
C413	4030018770	S.CER C3216 CH 2J 102J-T	T	139.8/102.7
C415	4030018410	S.CER ERF22X 6C2H 2R0C D01L	T	143.1/139.4
C416	4030006880	S.CER C1608 JB 1H 472K-T	T	103.1/96.7
C417	4030018040	S.CER ERF22X 6C2H 180J D01L	T	139.2/136.2
C418	4030011120	S.CER GRM31M2C2H100JV01L (GRM42-6 CH)	B	134.1/134.2
C419	4030011020	S.CER GRM31M4C2H1R0CY21L (GRM42-6 CK)	B	132.6/138.2
C420	4030011080	S.CER GRM31M2C2H6R0DV01L (GRM42-6 CH)	B	129.2/139.5
C421	4030011020	S.CER GRM31M4C2H1R0CY21L (GRM42-6 CK)	B	120.6/136.8
C422	4030011120	S.CER GRM31M2C2H100JV01L (GRM42-6 CH)	B	121.7/141.1
C423	4030007090	S.CER C1608 CH 1H 470J-T	B	127.8/131.7

[PA UNIT]

REF NO.	PARTS NO.	DESCRIPTION	M.	H/V LOCATION
C424	4030011090	S.CER GRM31M2C2H7R0DV01L (GRM42-6 CH)	B	119/140.3
C425	4030011180	S.CER GRM31M2C2H220JV01L (GRM42-6 CH)	T	121.6/137.4
C426	4030006860	S.CER C1608 JB 1H 102K-T	B	106.7/133.9
C427	4030011020	S.CER GRM31M4C2H1R0CY21L (GRM42-6 CK)	[EUR] B	102.6/139.6
	4030011020	S.CER GRM31M4C2H1R0CY21L (GRM42-6 CK)	[FRA]	
	4030011020	S.CER GRM31M4C2H1R0CY21L (GRM42-6 CK)	[ESP]	
	4030011020	S.CER GRM31M4C2H1R0CY21L (GRM42-6 CK)	[USA]	
	4030011020	S.CER GRM31M4C2H1R0CY21L (GRM42-6 CK)	[EXP]	
	4030011020	S.CER GRM31M4C2H1R0CY21L (GRM42-6 CK)	[ITR]	
	4030011040	S.CER GRM31M4C2H2R0CY21L (GRM42-6 CK)	[UK]	
	4030011020	S.CER GRM31M4C2H1R0CY21L (GRM42-6 CK)	[KOR]	
	4030011020	S.CER GRM31M4C2H1R0CY21L (GRM42-6 CK)	[AUS]	
	4030011020	S.CER GRM31M4C2H1R0CY21L (GRM42-6 CK)	[CHN]	
C428	4030011090	S.CER GRM31M2C2H7R0DV01L (GRM42-6 CH)	T	97/138.1
C429	4030017940	S.CER ERF22X 6C2H 680J D01L	T	92.3/136.9
C430	4030019410	S.CER GRM31A7U2J471JW31D	B	94.2/138
C431	4030011070	S.CER GRM31M2C2H5R0CY21L (GRM42-6 CH)	T	86.9/133.8
C432	4030004820	S.CER C2012 CH 1H 050C-T	B	99.2/139.3
C433	4030011090	S.CER GRM31M2C2H7R0DV01L (GRM42-6 CH)	T	76.1/132.2
C434	4030006860	S.CER C1608 JB 1H 102K-T	B	89.9/124.9
C435	4030006860	S.CER C1608 JB 1H 102K-T	B	97.2/127.7
C436	4030006860	S.CER C1608 JB 1H 102K-T	T	98.4/130.9
C438	4030006850	S.CER C1608 JB 1H 471K-T	B	90.8/134
C439	4030006860	S.CER C1608 JB 1H 102K-T	B	92.8/133.1
C440	4030004710	S.CER C2012 JB 1H 471K-T	B	103.5/135.5
C441	4030011090	S.CER GRM31M2C2H7R0DV01L (GRM42-6 CH)	T	137.6/140.4
C443	4030011020	S.CER GRM31M4C2H1R0CY21L (GRM42-6 CK)	B	122.1/131
C444	4030006860	S.CER C1608 JB 1H 102K-T	B	59.3/117.9
C452	4030007020	S.CER C1608 CH 1H 120J-T	B	87.3/119.3
C453	4030006860	S.CER C1608 JB 1H 102K-T	T	63.9/117.3
C456	4030009350	S.CER C1608 CH 1H 3R5B-T	B	78.2/118.4
C458	4030006860	S.CER C1608 JB 1H 102K-T	T	73.8/113.1
C461	4030011600	S.CER C1608 JB 1E 104K-T	B	68.8/113.3
C462	4030011600	S.CER C1608 JB 1E 104K-T	B	77.1/110.8
C463	4030006860	S.CER C1608 JB 1H 102K-T	B	79.7/109.6
C464	4030011600	S.CER C1608 JB 1E 104K-T	B	77.7/105.9
C465	4030011600	S.CER C1608 JB 1E 104K-T	B	67.7/108.9
C466	4030006860	S.CER C1608 JB 1H 102K-T	B	77.7/104.6
C467	4030006860	S.CER C1608 JB 1H 102K-T	B	67.7/107.6
C468	4030007020	S.CER C1608 CH 1H 120J-T	B	73.7/101.1
C470	4030011600	S.CER C1608 JB 1E 104K-T	B	77.7/101.7
C471	4030006860	S.CER C1608 JB 1H 102K-T	B	77.7/100.4
C472	4030009500	S.CER C1608 CH 1H 0R5B-T	B	69.7/105.2
C473	4030007040	S.CER C1608 CH 1H 180J-T	B	69.7/104
C474	4030009530	S.CER C1608 CH 1H 030B-T	B	67.7/101.7
C475	4030006860	S.CER C1608 JB 1H 102K-T	B	66.5/98.8
C476	4030006860	S.CER C1608 JB 1H 102K-T	B	68/111.3
C477	4030006860	S.CER C1608 JB 1H 102K-T	B	79.1/121.9
C478	4030006860	S.CER C1608 JB 1H 102K-T	B	57.7/120.5
C479	4030006860	S.CER C1608 JB 1H 102K-T	B	56.9/121.8
C480	4030007090	S.CER C1608 CH 1H 470J-T	B	63.4/100.8
C481	4030006860	S.CER C1608 JB 1H 102K-T	B	69.6/96.3
C482	4030006860	S.CER C1608 JB 1H 102K-T	B	67.9/94.5
C483	4030006860	S.CER C1608 JB 1H 102K-T	B	64.2/98.8
C484	4030007010	S.CER C1608 CH 1H 100D-T	B	74.3/108.1
C485	4030017810	S.CER C1608 CH 1H 102J-T	B	69.8/107.4
C501	4030006860	S.CER C1608 JB 1H 102K-T	T	109.3/87.9
C503	4030011070	S.CER GRM31M2C2H5R0CY21L (GRM42-6 CH)	T	119.4/130.3
C504	4030017960	S.CER ERF22X 6C2H 330J D01L	T	111.8/122.1
C505	4030011040	S.CER GRM31M4C2H2R0CY21L (GRM42-6 CK)	B	114.4/125.4
C506	4030011120	S.CER GRM31M2C2H100JV01L (GRM42-6 CH)	B	118.2/125.6
C507	4030011040	S.CER GRM31M4C2H2R0CY21L (GRM42-6 CK)	B	113.8/131.5
C508	4030011070	S.CER GRM31M2C2H5R0CY21L (GRM42-6 CH)	B	110.4/132.8
C509	4030007150	S.CER C1608 CH 1H 151J-T	B	110.2/121.5
C511	4030018770	S.CER C3216 CH 2J 102J-T	T	109.6/125.4
C513	4030006860	S.CER C1608 JB 1H 102K-T	B	97.1/117.6
C514	4030011170	S.CER GRM31M2C2H180JV01L (GRM42-6 CH)	T	98.4/118.1
C515	4030018770	S.CER C3216 CH 2J 102J-T	T	96.9/120.4
C516	4030011100	S.CER GRM31M2C2H8R0DV01L (GRM42-6 CH)	T	88.2/124.1
C517	4030004880	S.CER C2012 CH 1H 120J-T	B	92.5/115.1
C518	4030018770	S.CER C3216 CH 2J 102J-T	B	94.1/121.4
C519	4030011190	S.CER GRM31M2C2H270JV01L (GRM42-6 CH)	T	86.1/124.1

M.=Mounted side (T: Mounted on the Top side, B: Mounted on the Bottom side) S.=Surface mount

[PA UNIT]

REF NO.	PARTS NO.	DESCRIPTION	M.	H/V LOCATION
C520	4030004870	S.CER C2012 CH 1H 100D-T	B	93.4/112.4
C521	4030011290	S.CER GRM31M2C2H240JV01L (GRM42-6 CH)	T	81.2/123.9
C522	4030006850	S.CER C1608 JB 1H 471K-T	T	96.3/107.7
C523	4030006860	S.CER C1608 JB 1H 102K-T	T	79.3/119.1
C524	4030006910	S.CER C1608 CH 1H 0R5C-T	T	79.9/120.9
C525	4030004720	S.CER C2012 JB 1H 102K-T	T	86.7/112.1
C526	4030007150	S.CER C1608 CH 1H 151J-T	B	113.3/121.5
C527	4030007150	S.CER C1608 CH 1H 151J-T	B	111.1/127.8
C528	4030006860	S.CER C1608 JB 1H 102K-T	B	96.2/114.5
C530	4030011230	S.CER GRM31M2C2H390JV01L (GRM42-6 CH)	T	120.8/113.3
C531	4030018770	S.CER C3216 CH 2J 102J-T	B	106/109.3
C532	4030018770	S.CER C3216 CH 2J 102J-T	B	103.1/109.2
C533	4030018770	S.CER C3216 CH 2J 102J-T	T	118.6/107
C534	4030017880	S.CER ERF22X 6C2H 560J D01L (GM111)	B	112.7/103.9
C535	4030017880	S.CER ERF22X 6C2H 560J D01L (GM111)	B	124.1/103.9
C536	4030017980	S.CER ERF22X 6C2H 470J D01L	T	101/110.8
C537	4030017940	S.CER ERF22X 6C2H 680J D01L	T	101/114.2
C538	4030017880	S.CER ERF22X 6C2H 560J D01L (GM111)	T	131.2/117.5
C541	4030011060	S.CER GRM31M2C2H4R0CY21L (GRM42-6 CH)	T	125.1/123.7
C542	4030012480	S.CER GRM31M2C2H121JV01L (GRM42-6 CH)	T	123.4/128.7
C544	4030011730	S.CER GRM31M2C2H101JV01L (GRM42-6 CH)	T	129.9/123.5
C545	4030017940	S.CER ERF22X 6C2H 680J D01L	B	112.7/109.9
C551	4030006880	S.CER C1608 JB 1H 472K-T	T	80.1/117.1
C552	4030006860	S.CER C1608 JB 1H 102K-T	T	73/120.5
C553	4030006850	S.CER C1608 JB 1H 471K-T	T	69.4/114.7
C554	4030006860	S.CER C1608 JB 1H 102K-T	T	66.8/114.7
C555	4030006860	S.CER C1608 JB 1H 102K-T	T	63.1/111.7
C556	4030011600	S.CER C1608 JB 1E 104K-T	T	68.3/111.2
C557	4030006860	S.CER C1608 JB 1H 102K-T	T	70.8/108.5
C558	4030006860	S.CER C1608 JB 1H 102K-T	T	65.4/108.6
C559	4030006860	S.CER C1608 JB 1H 102K-T	T	66/103.5
C560	4030006860	S.CER C1608 JB 1H 102K-T	B	65.3/112.9
C561	4030006850	S.CER C1608 JB 1H 471K-T	T	70.1/105.3
C562	4030006860	S.CER C1608 JB 1H 102K-T	T	69.2/94.9
C563	4030006860	S.CER C1608 JB 1H 102K-T	T	62.3/106.1
C564	4030006860	S.CER C1608 JB 1H 102K-T	T	65/97
C565	4030006860	S.CER C1608 JB 1H 102K-T	T	62.3/103
C567	4030006860	S.CER C1608 JB 1H 102K-T	T	69.2/120.9
C601	4030011070	S.CER GRM31M2C2H5R0CY21L (GRM42-6 CH)	T	69.5/132.7
C602	4030011090	S.CER GRM31M2C2H7R0DV01L (GRM42-6 CH)	T	67/136.8
C701	4030017320	S.CER GRM21BB11H104KA01L (GM40-034)	B	109.8/33.4
C702	4030006860	S.CER C1608 JB 1H 102K-T	B	107.7/33.2
C703	4030011600	S.CER C1608 JB 1E 104K-T	B	83.8/16.9
C704	4510004601	ELE 16 ME 1000 HC		
C705	4030011600	S.CER C1608 JB 1E 104K-T	B	79/16.9
C706	4510004601	ELE 16 ME 1000 HC		
C707	4030017320	S.CER GRM21BB11H104KA01L (GM40-034)	B	67.1/18.6
C708	4030006900	S.CER C1608 JB 1H 103K-T	T	63.2/27.8
C709	4030006860	S.CER C1608 JB 1H 102K-T	T	63.2/26.5
C710	4030006850	S.CER C1608 JB 1H 471K-T	T	63.2/25.2
C711	4030007170	S.CER C1608 CH 1H 221J-T	T	63.2/23.9
C712	4030007170	S.CER C1608 CH 1H 221J-T	B	70.4/18.7
C713	4510004591	ELE 16 ME 470 HC		
C715	4030006860	S.CER C1608 JB 1H 102K-T	B	97.1/118.9
C718	4030011600	S.CER C1608 JB 1E 104K-T	B	128.4/19.3
C719	4030011600	S.CER C1608 JB 1E 104K-T	T	125.8/16.4
C720	4030011600	S.CER C1608 JB 1E 104K-T	B	130.5/38.7
C722	4030007130	S.CER C1608 CH 1H 101J-T	T	88.9/6.7
C723	4030007130	S.CER C1608 CH 1H 101J-T	T	78.3/3.1
C724	4030011340	S.CER C1608 CH 1H 471J-T	B	134.8/12.2
C725	4550007350	S.STAN F931C226MCMBMA	B	126.6/35.3
C726	4030006860	S.CER C1608 JB 1H 102K-T	B	91.3/111
C727	4030006860	S.CER C1608 JB 1H 102K-T	B	84.4/114.1
C728	4030006860	S.CER C1608 JB 1H 102K-T	B	91.2/112.6
C729	4030006860	S.CER C1608 JB 1H 102K-T	B	65.1/114.8
C732	4030011600	S.CER C1608 JB 1E 104K-T	T	71.8/2.6
C733	4030011600	S.CER C1608 JB 1E 104K-T	T	66.8/12.9
C734	4030006860	S.CER C1608 JB 1H 102K-T	B	63.5/1.8
C735	4030011600	S.CER C1608 JB 1E 104K-T	T	74.1/13.2
C736	4030011600	S.CER C1608 JB 1E 104K-T	B	67.3/1.8
C737	4030011600	S.CER C1608 JB 1E 104K-T	B	65.4/1.8
C738	4030011600	S.CER C1608 JB 1E 104K-T	B	68.2/14.5
C739	4030011600	S.CER C1608 JB 1E 104K-T	B	69.8/14.5
C741	4030011600	S.CER C1608 JB 1E 104K-T	B	78.5/6.4
C742	4030011600	S.CER C1608 JB 1E 104K-T	T	69.4/12.9
C743	4030006860	S.CER C1608 JB 1H 102K-T	T	68.1/12.9
C744	4030011600	S.CER C1608 JB 1E 104K-T	T	70.7/12.9
C745	4030011600	S.CER C1608 JB 1E 104K-T	B	77.7/14.3
C746	4030011600	S.CER C1608 JB 1E 104K-T	B	76.2/15.1
C747	4030011600	S.CER C1608 JB 1E 104K-T	T	98.5/4.1
C749	4030011600	S.CER C1608 JB 1E 104K-T	T	96.6/6.4
C750	4030006880	S.CER C1608 JB 1H 472K-T	T	94.2/6.4
C751	4030006860	S.CER C1608 JB 1H 102K-T	T	95.4/6.4
C752	4030011600	S.CER C1608 JB 1E 104K-T	T	93/6.4
C753	4030006880	S.CER C1608 JB 1H 472K-T	B	59.9/10.7

[PA UNIT]

REF NO.	PARTS NO.	DESCRIPTION	M.	H/V LOCATION
C754	4030006860	S.CER C1608 JB 1H 102K-T	B	66.6/14.5
C755	4030006860	S.CER C1608 JB 1H 102K-T	B	58.5/119.2
C757	4030011600	S.CER C1608 JB 1E 104K-T	B	76.4/8
C759	4030006880	S.CER C1608 JB 1H 472K-T	T	72.8/13.2
C760	4030006880	S.CER C1608 JB 1H 472K-T	B	74.8/8
C761	4030006880	S.CER C1608 JB 1H 472K-T	B	73.2/8
C762	4030006880	S.CER C1608 JB 1H 472K-T	B	70/8
C763	4030006880	S.CER C1608 JB 1H 472K-T	B	71.6/8
C764	4030006880	S.CER C1608 JB 1H 472K-T	B	61.9/1.8
C765	4030011600	S.CER C1608 JB 1E 104K-T	B	68.9/1.8
C766	4030006860	S.CER C1608 JB 1H 102K-T	B	66.5/8.7
C781	4030006860	S.CER C1608 JB 1H 102K-T	T	73/90.1
C782	4030006900	S.CER C1608 JB 1H 103K-T	T	71.8/84.3
C783	4030006880	S.CER C1608 JB 1H 472K-T	T	71.8/83.1
C801	4030007070	S.CER C1608 CH 1H 330J-T	T	55/58.5
C802	4030009470	S.CER C1608 CH 1H R75C-T	T	53.7/58.5
C803	4030007100	S.CER C1608 CH 1H 560J-T	T	53.8/53.2
C804	4030007030	S.CER C1608 CH 1H 150J-T	T	56.2/52.5
C805	4030007080	S.CER C1608 CH 1H 390J-T	T	53.8/51.6
C806	4030006880	S.CER C1608 JB 1H 472K-T	B	47.1/39.8
C807	4030011600	S.CER C1608 JB 1E 104K-T	B	43.2/38.6
C808	4030011600	S.CER C1608 JB 1E 104K-T	B	43.1/44.5
C820	4030011600	S.CER C1608 JB 1E 104K-T	B	54.1/91.2
C821	4030006880	S.CER C1608 JB 1H 472K-T	B	53.5/99.2
C822	4030011510	S.CER GRM31M2C2H560JV01L (GRM42-6 CH)	B	42.2/21.9
C823	4030011190	S.CER GRM31M2C2H270JV01L (GRM42-6 CH)	B	32.9/18.3
C824	4030012480	S.CER GRM31M2C2H121JV01L (GRM42-6 CH)	B	25.1/17.1
C825	4030011240	S.CER GRM31M2C2H470JV01L (GRM42-6 CH)	B	17.9/15.7
C826	4030011550	S.CER GRM31M2C2H680JV01L (GRM42-6 CH)	B	11.2/19.9
C827	4030011510	S.CER GRM31M2C2H560JV01L (GRM42-6 CH)	B	8.8/19.9
C828	4030006880	S.CER C1608 JB 1H 472K-T	T	5.2/106.7
C829	4030011600	S.CER C1608 JB 1E 104K-T	T	2.6/107.6
C830	4030011210	S.CER GRM31M2C2H330JV01L (GRM42-6 CH)	B	22.4/17.1
C831	4030006880	S.CER C1608 JB 1H 472K-T	B	7.5/109.2
C832	4030006880	S.CER C1608 JB 1H 472K-T	B	51.5/95.4
C833	4030011730	S.CER GRM31M2C2H101JV01L (GRM42-6 CH)	B	27.5/17.1
C835	4030012480	S.CER GRM31M2C2H121JV01L (GRM42-6 CH)	B	16.6/107.1
C836	4030012480	S.CER GRM31M2C2H121JV01L (GRM42-6 CH)	B	12.5/107.8
C837	4030012480	S.CER GRM31M2C2H121JV01L (GRM42-6 CH)	B	12.5/105.7
C840	4030011600	S.CER C1608 JB 1E 104K-T	B	42.8/97.3
C841	4030006880	S.CER C1608 JB 1H 472K-T	B	46/98.5
C842	4030011730	S.CER GRM31M2C2H101JV01L (GRM42-6 CH)	B	39/106.8
C843	4010008160	CER HM13SJ SL 431J 500V		
C844	4030011730	S.CER GRM31M2C2H101JV01L (GRM42-6 CH)	B	25.9/102.9
C845	4030014460	S.CER GRM31M2C2H820JV01L (GRM42-6 CH)	B	19.7/91.9
C846	4010005370	CER HM11SJ SL 331J 500V		
C847	4010005930	CER HM11SJ SL 391J 500V		
C848	4030011190	S.CER GRM31M2C2H270JV01L (GRM42-6 CH)	B	12.5/98.2
C849	4030011180	S.CER GRM31M2C2H220JV01L (GRM42-6 CH)	B	12.6/96.1
C850	4010005930	CER HM11SJ SL 391J 500V		
C851	4030012480	S.CER GRM31M2C2H121JV01L (GRM42-6 CH)	T	20.2/112
C852	4030006880	S.CER C1608 JB 1H 472K-T	T	5.3/90.5
C853	4030011600	S.CER C1608 JB 1E 104K-T	T	2.6/90.5
C854	4030006880	S.CER C1608 JB 1H 472K-T	B	7.7/92.8
C855	4030011730	S.CER GRM31M2C2H101JV01L (GRM42-6 CH)	B	27.9/104.9
C856	4030011510	S.CER GRM31M2C2H560JV01L (GRM42-6 CH)	B	31.2/105.5
C857	4030012480	S.CER GRM31M2C2H121JV01L (GRM42-6 CH)	B	43.1/108.3
C858	4030011730	S.CER GRM31M2C2H101JV01L (GRM42-6 CH)	B	20.2/109.9
C860	4030011600	S.CER C1608 JB 1E 104K-T	B	43.4/83.8
C861	4030006880	S.CER C1608 JB 1H 472K-T	B	46.6/83.8
C863	4030011170	S.CER GRM31M2C2H180JV01L (GRM42-6 CH)	B	37.5/93.5
C864	4030011510	S.CER GRM31M2C2H560JV01L (GRM42-6 CH)	B	28.5/82.6
C865	4030011110	S.CER GRM31M2C2H9R0DV01L (GRM42-6 CH)	B	29.4/78.6
C866	4030011230	S.CER GRM31M2C2H390JV01L (GRM42-6 CH)	B	24.4/78
C868	4030011240	S.CER GRM31M2C2H470JV01L (GRM42-6 CH)	B	26.8/78.6
C869	4030011180	S.CER GRM31M2C2H220JV01L (GRM42-6 CH)	B	10.3/83.5
C870	4030011170	S.CER GRM31M2C2H180JV01L (GRM42-6 CH)	B	17/77.7
C871	4030006880	S.CER C1608 JB 1H 472K-T	T	5.2/74.4
C872	4030011600	S.CER C1608 JB 1E 104K-T	T	2.5/74.4

M.=Mounted side (T: Mounted on the Top side, B: Mounted on the Bottom side) S.=Surface mount

[PA UNIT]

REF NO.	PARTS NO.	DESCRIPTION	M.	H/V LOCATION
C873	4030011070	S.CER GRM31M2C2H5R0CY21L (GRM42-6 CH)	B	33.2/92.6
C874	4030006880	S.CER C1608 JB 1H 472K-T	B	9/74.5
C876	4030011160	S.CER GRM31M2C2H150JV01L (GRM42-6 CH)	B	22/77.4
C880	4030011600	S.CER C1608 JB 1E 104K-T	B	43.4/69.1
C881	4030006880	S.CER C1608 JB 1H 472K-T	B	47/69.1
C882	4010007590	CER HM15SJ SL 681J 500V		
C883	4010007590	CER HM15SJ SL 681J 500V		
C884	4010005930	CER HM11SJ SL 391J 500V		
C885	4320000320	DIP DM20C 222J5		
C886	4030012480	S.CER GRM31M2C2H121JV01L (GRM42-6 CH)	B	31.5/57.2
C887	4030011730	S.CER GRM31M2C2H101JV01L (GRM42-6 CH)	B	33.9/57.2
C889	4030014460	S.CER GRM31M2C2H820JV01L (GRM42-6 CH)	B	18/65.3
C890	4320001250	DIP DM19C 162J5		
C893	4030006880	S.CER C1608 JB 1H 472K-T	T	5.3/58.3
C894	4030011600	S.CER C1608 JB 1E 104K-T	T	2.6/58.3
C900	4030011600	S.CER C1608 JB 1E 104K-T	B	44/54.4
C901	4030006880	S.CER C1608 JB 1H 472K-T	B	46.8/54.4
C902	4010005870	CER HM95SJ SL 221J 500V		
C903	4030011190	S.CER GRM31M2C2H270JV01L (GRM42-6 CH)	B	30.9/42.7
C904	4030014460	S.CER GRM31M2C2H820JV01L (GRM42-6 CH)	B	28.4/42.7
C905	4010005870	CER HM95SJ SL 221J 500V		
C906	4030011510	S.CER GRM31M2C2H560JV01L (GRM42-6 CH)	B	17/44
C907	4030011510	S.CER GRM31M2C2H560JV01L (GRM42-6 CH)	B	10.8/49.5
C908	4030006880	S.CER C1608 JB 1H 472K-T	T	5.3/42.1
C909	4030011600	S.CER C1608 JB 1E 104K-T	T	2.6/42.1
C920	4030011600	S.CER C1608 JB 1E 104K-T	B	43.2/25.1
C921	4030006880	S.CER C1608 JB 1H 472K-T	B	47.1/25.4
C922	4010007590	CER HM15SJ SL 681J 500V		
C923	4030011730	S.CER GRM31M2C2H101JV01L (GRM42-6 CH)	B	31.4/27.3
C924	4010006410	CER HM13SJ SL 471J 500V		
C925	4030014460	S.CER GRM31M2C2H820JV01L (GRM42-6 CH)	B	15.7/29.5
C926	4010006410	CER HM13SJ SL 471J 500V		
C927	4010005930	CER HM11SJ SL 391J 500V		
C928	4010005930	CER HM11SJ SL 391J 500V		
C929	4030006880	S.CER C1608 JB 1H 472K-T	T	5.3/25.8
C930	4030011600	S.CER C1608 JB 1E 104K-T	T	2.6/25.8
C931	4030014460	S.CER GRM31M2C2H820JV01L (GRM42-6 CH)	B	34.1/27.3
C932	4030011730	S.CER GRM31M2C2H101JV01L (GRM42-6 CH)	B	33.3/32.4
C933	4030011730	S.CER GRM31M2C2H101JV01L (GRM42-6 CH)	B	29.7/30.9
C940	4030011600	S.CER C1608 JB 1E 104K-T	B	43.6/11.1
C941	4030006880	S.CER C1608 JB 1H 472K-T	B	43.6/14.2
C942	4030014460	S.CER GRM31M2C2H820JV01L (GRM42-6 CH)	B	39.5/119.2
C943	4030011210	S.CER GRM31M2C2H330JV01L (GRM42-6 CH)	B	28.9/111.7
C944	4030014460	S.CER GRM31M2C2H820JV01L (GRM42-6 CH)	B	24.7/118.4
C945	4030011170	S.CER GRM31M2C2H180JV01L (GRM42-6 CH)	B	16.5/118.1
C947	4030006880	S.CER C1608 JB 1H 472K-T	T	5.3/9.9
C948	4030011600	S.CER C1608 JB 1E 104K-T	T	2.6/9.9
C949	4030011050	S.CER GRM31M3C2H3R0CY21L (GRM42-6 CJ)	B	28.9/109.6
C960	4030010760	S.CER C1608 CH 1H 331J-T	T	18.1/130.2
C961	4030011600	S.CER C1608 JB 1E 104K-T	B	45.1/134.1
C962	4030006880	S.CER C1608 JB 1H 472K-T	B	39/137.8
C963	4030006880	S.CER C1608 JB 1H 472K-T	B	38.7/126.3
C964	4610002120	S.TRI TZB4Z100EB10R00 (TZBX4Z100BE110)	T	3.3/126.6
C966	4030006880	S.CER C1608 JB 1H 472K-T	B	21.2/131.2
C968	4030011340	S.CER C1608 CH 1H 471J-T	B	31/130.5
C969	4030011340	S.CER C1608 CH 1H 471J-T	B	31/133.6
C970	4030010760	S.CER C1608 CH 1H 331J-T	B	22/132.8
C971	4030011340	S.CER C1608 CH 1H 471J-T	B	35.8/133.6
C972	4030011790	S.CER GRM55RF52A684ZD01L (GRM44-1)	B	3.4/136.4
C973	4030007090	S.CER C1608 CH 1H 470J-T	B	8.3/129.8
C979	4030006880	S.CER C1608 JB 1H 472K-T	T	51.8/38.6
C987	4030006880	S.CER C1608 JB 1H 472K-T	B	28.9/3.3
C988	4030006880	S.CER C1608 JB 1H 472K-T	B	26.3/3.3
C989	4030006880	S.CER C1608 JB 1H 472K-T	B	25/2.6
C990	4030006880	S.CER C1608 JB 1H 472K-T	T	20.6/3
C991	4030006880	S.CER C1608 JB 1H 472K-T	T	20.6/4.2
C992	4030006880	S.CER C1608 JB 1H 472K-T	T	20.6/5.4
C993	4030006880	S.CER C1608 JB 1H 472K-T	T	20.6/6.6
C994	4030011600	S.CER C1608 JB 1E 104K-T	B	29.5/6.1
C995	4030006880	S.CER C1608 JB 1H 472K-T	B	23.7/3.4
C996	4030007090	S.CER C1608 CH 1H 470J-T	T	20.6/9
C997	4030007090	S.CER C1608 CH 1H 470J-T	T	20.6/7.8
C998	4030007090	S.CER C1608 CH 1H 470J-T	T	20.6/10.2
C999	4030006860	S.CER C1608 JB 1H 102K-T	T	56.8/9.5
C1000	4030006860	S.CER C1608 JB 1H 102K-T	B	55.5/5
C1001	4030011600	S.CER C1608 JB 1E 104K-T	B	51.6/1.7

[PA UNIT]

REF NO.	PARTS NO.	DESCRIPTION	M.	H/V LOCATION
C1002	4030006880	S.CER C1608 JB 1H 472K-T	B	27.6/2.6
C1003	4030011600	S.CER C1608 JB 1E 104K-T	T	49.8/7.6
C1004	4030011510	S.CER GRM31M2C2H560JV01L (GRM42-6 CH)	B	39.8/21.9
C1005	4030011550	S.CER GRM31M2C2H680JV01L (GRM42-6 CH)	B	16.8/91.9
C1006	4030014460	S.CER GRM31M2C2H820JV01L (GRM42-6 CH)	B	39/109.2
C1007	4030011550	S.CER GRM31M2C2H680JV01L (GRM42-6 CH)	B	18.1/62.1
C1009	4030011510	S.CER GRM31M2C2H560JV01L (GRM42-6 CH)	B	20.6/118.7
C1010	4030014460	S.CER GRM31M2C2H820JV01L (GRM42-6 CH)	B	27.1/119.5
C1121	4010006410	CER HM13SJ SL 471J 500V		
RL701	6330001550	REL JV-12-KT		
RL801	6330001721	REL ATN207-K1		
RL820	6330001721	REL ATN207-K1		
RL821	6330001721	REL ATN207-K1		
RL840	6330001721	REL ATN207-K1		
RL841	6330001721	REL ATN207-K1		
RL860	6330001721	REL ATN207-K1		
RL861	6330001721	REL ATN207-K1		
RL880	6330001721	REL ATN207-K1		
RL881	6330001721	REL ATN207-K1		
RL900	6330001721	REL ATN207-K1		
RL901	6330001721	REL ATN207-K1		
RL920	6330001721	REL ATN207-K1		
RL921	6330001721	REL ATN207-K1		
RL940	6330001721	REL ATN207-K1		
RL941	6330001721	REL ATN207-K1		
J2	6510023511	S.CON 28FLT-SM2-TB(LF)(SN)	T	80.1/6
J980	6510023511	S.CON 28FLT-SM2-TB(LF)(SN)	T	63.7/6
F1	5220000341	HOL FHA010-03F		
F2	5210000940	FUS 1205		
W701	8900013900	CAB OPC-1455		
W702	8900013910	CAB OPC-1456		
W801	7120000480	S.JUM MJP-0.4-T	B	8.3/100.9
W901	7120000480	S.JUM MJP-0.4-T	T	56.7/22
EP202	6910012350	S.BEA MMZ1608Y 102BT	B	136/51.3
EP703	6910012350	S.BEA MMZ1608Y 102BT	B	142.6/13.9
EP741	6910012350	S.BEA MMZ1608Y 102BT	B	76.4/11.9
EP742	6910012350	S.BEA MMZ1608Y 102BT	B	77.8/11.3
EP743	6910012350	S.BEA MMZ1608Y 102BT	B	59.8/99.5
EP747	6910012350	S.BEA MMZ1608Y 102BT	T	65/9.6
EP748	6910012350	S.BEA MMZ1608Y 102BT	T	63.8/9.6
EP751	6910012350	S.BEA MMZ1608Y 102BT	T	74.1/9.6
EP752	6910012350	S.BEA MMZ1608Y 102BT	B	63.4/5.2
EP753	6910012350	S.BEA MMZ1608Y 102BT	T	66.4/9.6
EP754	6910012350	S.BEA MMZ1608Y 102BT	B	59.3/115.8
EP756	6910012350	S.BEA MMZ1608Y 102BT	T	68.6/2.6
EP758	6910012350	S.BEA MMZ1608Y 102BT	T	70.3/9.6
EP759	6910012350	S.BEA MMZ1608Y 102BT	T	69.1/9.6
EP760	6910012350	S.BEA MMZ1608Y 102BT	T	60.6/10
EP761	6910012350	S.BEA MMZ1608Y 102BT	T	62.5/9.6
EP762	6910012350	S.BEA MMZ1608Y 102BT	B	61/4.6
EP763	6910012350	S.BEA MMZ1608Y 102BT	B	63.3/105.6
EP767	6910012350	S.BEA MMZ1608Y 102BT	B	76.4/5.2
EP772	6910012350	S.BEA MMZ1608Y 102BT	T	96.4/3.8
EP774	6910012350	S.BEA MMZ1608Y 102BT	T	72.8/9.6
EP775	6910012350	S.BEA MMZ1608Y 102BT	B	74.8/5.2
EP776	6910012350	S.BEA MMZ1608Y 102BT	B	73.2/5.2
EP777	6910012350	S.BEA MMZ1608Y 102BT	B	70/5.2
EP778	6910012350	S.BEA MMZ1608Y 102BT	B	71.6/5.2
EP779	6910012350	S.BEA MMZ1608Y 102BT	B	68.2/5.2

M.=Mounted side (T: Mounted on the Top side, B: Mounted on the Bottom side)
S.=Surface mount

[DRIVER UNIT]

REF NO.	PARTS NO.	DESCRIPTION	M.	H/V LOCATION
Q504	1590003061	S.FET PD55015-E	T	20/9.7
R102	7070000271	RES ERG1SJ 101 (100)		
C101	4030004750	S.CER C2012 JB 1H 103K-T	T	24.6/18.2
C102	4030011230	S.CER GRM31M2C2H390JV01L (GRM42-6 CH)	T	11.2/4.2
J101	6910016830	CON IMSA-9230B-1-04Z149-PT1		
J102	6910016830	CON IMSA-9230B-1-04Z149-PT1		
J103	6910016830	CON IMSA-9230B-1-04Z149-PT1		
J104	6910016830	CON IMSA-9230B-1-04Z149-PT1		
J107	6910016830	CON IMSA-9230B-1-04Z149-PT1		

[DISPLAY UNIT]

REF NO.	PARTS NO.	DESCRIPTION	M.	H/V LOCATION
IC1	6910016730	S.DC XC9504B092ARN	B	44.4/9.4
IC101	1180001071	S.IC TA7805F(TE16L,Q)	B	90.3/6.9
IC151	1180002201	S.IC RN5RZ33BA-TR-F	B	99.9/4.8
IC301	1110002751	S.IC TA75S01F(TE85R,F)	B	113.8/7.5
IC506	1120003010	S.IC AN253FH-V	B	69/38.5
IC651	1110005420	S.IC BA15532F-E2	B	4.1/25.6
IC2003	1140013140	S.IC HD643380205B68HV(SX-2427C)	B	93/26.3
IC2007	1110005821	S.IC R3112N281A-TR-F	B	108.7/46.9
Q1	1550000090	S.FET RSQ035P03TR	B	39.4/9.8
Q51	1560001330	S.FET RSR025N03	B	52.1/10.6
Q301	1560001290	S.FET 2SK3065 T100	T	110.8/31.4
Q302	1590003940	S.TRA RN1105(TE85L,F)	T	116.7/10.2
Q303	1590003930	S.TRA UMD22N TR	T	113.1/11.5
Q651	1590001650	S.TRA XP4601(TX)	B	10.6/28.8
Q652	1590001650	S.TRA XP4601(TX)	B	11.1/20.6
Q653	1590001650	S.TRA XP4601(TX)	B	10.6/26.2
Q654	1590001650	S.TRA XP4601(TX)	B	11.1/17
Q701	1530002060	S.TRA 2SC4081 T106 R	T	19.1/50.3
Q721	1530002060	S.TRA 2SC4081 T106 R	T	22/5.8
Q741	1530002060	S.TRA 2SC4081 T106 R	T	94/50.1
Q761	1530002060	S.TRA 2SC4081 T106 R	T	104.2/50.1
Q771	1530002060	S.TRA 2SC4081 T106 R	T	18.4/25.1
Q781	1530002060	S.TRA 2SC4081 T106 R	T	5.3/23.6
Q802	1520000460	S.TRA 2SB1132 T100 R	B	58.8/21.6
Q851	1590002771	S.FET CPH3404-TL-E	B	39.9/18.4
Q2001	1590003940	S.TRA RN1105(TE85L,F)	B	81.6/23.7
Q2002	1590001870	S.TRA DTA114EE TL	B	80.1/29.7
Q2003	1590003480	S.TRA DTC114TE TL	B	82.2/32.3
D1	1790000970	S.DIO MA729(TX)	B	36.8/10.1
D51	1750000730	S.DIO MA2SD1000L	B	51/8
D301	1790001250	S.DIO MA2S111-(TX)	B	111/32
D302	1790001520	S.ZEN MA8075-L(TX)	B	109.9/7.6
D601	1750000950	S.DIO MA732(TX)	B	51.5/39.8
D602	1750000950	S.DIO MA732(TX)	B	53.3/39.8
D801	1730002340	S.ZEN MA8047-M(TX)	B	35/40.4
D802	1730002340	S.ZEN MA8047-M(TX)	B	39.8/25.9
D803	1730002340	S.ZEN MA8047-M(TX)	B	39.5/22.8
D804	1730002340	S.ZEN MA8047-M(TX)	B	42/22.9
D2001	1750000950	S.DIO MA732(TX)	T	107.4/26.5
D2002	1790001670	S.DIO RB706F-40T106	B	76.6/16.8
D2003	1790001670	S.DIO RB706F-40T106	T	116.4/36.7
D2004	1750000370	S.DIO DA221 TL	T	100.6/41.8
D2005	1750000370	S.DIO DA221 TL	B	101.7/42.8
D2006	1750000370	S.DIO DA221 TL	B	107.3/5.9
X501	6050012150	S.XTA CR-806 SMD-49TA 4.433619 MHz [EUR]	B	87/43.5
	6050012150	S.XTA CR-806 SMD-49TA 4.433619 MHz [FRA]		
	6050012150	S.XTA CR-806 SMD-49TA 4.433619 MHz [ESP]		
	6050012140	S.XTA CR-805 SMD-49TA 3.579545 MHz [USA]		
	6050012150	S.XTA CR-806 SMD-49TA 4.433619 MHz [EXP]		
	6050012150	S.XTA CR-806 SMD-49TA 4.433619 MHz [ITR]		
	6050012150	S.XTA CR-806 SMD-49TA 4.433619 MHz [UK]		
	6050012140	S.XTA CR-805 SMD-49TA 3.579545 MHz [KOR]		
	6050012150	S.XTA CR-806 SMD-49TA 4.433619 MHz [AUS]		
	6050012150	S.XTA CR-806 SMD-49TA 4.433619 MHz [CHN]		
X2001	6050011550	S.XTA CR-747 SMD-49TA 9.8304 MHz	B	106.5/27

[DISPLAY UNIT]

REF NO.	PARTS NO.	DESCRIPTION	M.	H/V LOCATION
L1	6190001561	S.COI CDRH5D18NP-101NC	B	68.4/6.3
L2	6190001561	S.COI CDRH5D18NP-101NC	B	34.6/5.2
L3	6200002041	S.COI NLV25T-101J	B	30.7/10.4
L51	6190001561	S.COI CDRH5D18NP-101NC	B	55.9/6.2
L53	6200002041	S.COI NLV25T-101J	B	60.9/10.9
L101	6200001831	S.COI NLV32T-100J	B	96/11.6
L151	6200001831	S.COI NLV32T-100J	B	96/8.6
L152	6200001831	S.COI NLV32T-100J	B	100.6/11.4
L251	6200003950	S.COI HF50ACC 322513-T	B	145.8/44
L252	6200003950	S.COI HF50ACC 322513-T	B	145.2/50.9
L301	6200002041	S.COI NLV25T-101J	B	109.6/16.7
L302	6200005011	S.COI NLV25T-100J	T	112.6/24
L303	6200002041	S.COI NLV25T-101J	T	112/20.3
L306	6200003261	S.COI NLV32T-101J	T	109.8/25.5
L307	6200002041	S.COI NLV25T-101J	T	115.4/26.6
L309	6200002041	S.COI NLV25T-101J	T	115.3/24
L310	6200002041	S.COI NLV25T-101J	T	115.4/21.5
L312	6200002041	S.COI NLV25T-101J	T	115.4/19
L313	6200002041	S.COI NLV25T-101J	T	115.7/16.3
L505	6200005521	S.COI NLV25T-470J	B	71.2/47.9
L506	6200005011	S.COI NLV25T-100J	B	67.9/20.2
L507	6200005011	S.COI NLV25T-100J	B	50.2/29
L508	6200005011	S.COI NLV25T-100J	B	49.3/24.3
L509	6200005011	S.COI NLV25T-100J	B	17.4/35.6
L601	6200002041	S.COI NLV25T-101J	B	70.6/25.2
L602	6200005011	S.COI NLV25T-100J	B	53.5/36.2
L603	6200005011	S.COI NLV25T-100J	B	51/43.3
L604	6200005011	S.COI NLV25T-100J	B	53.5/43.3
L605	6200005011	S.COI NLV25T-100J	B	50.9/36.2
L651	6200002041	S.COI NLV25T-101J	B	19.1/42.7
L701	6200002041	S.COI NLV25T-101J	B	21.1/37.5
L702	6200002041	S.COI NLV25T-101J	B	65.4/10.9
L703	6200002041	S.COI NLV25T-101J	B	27.9/11.3
L801	6200005011	S.COI NLV25T-100J	B	63.4/16.9
L802	6200002041	S.COI NLV25T-101J	B	19.1/47.5
L851	6200003950	S.COI HF50ACC 322513-T	B	33.2/17.2
L852	6200003950	S.COI HF50ACC 322513-T	B	35/21.3
L853	6200002041	S.COI NLV25T-101J	B	34.4/26.6
L854	6200002041	S.COI NLV25T-101J	B	34.4/24.1
L855	6200003950	S.COI HF50ACC 322513-T	B	36.4/17.2
R1	7030008141	S.RES ERA3YKD 224V (220K)	B	33.4/9.6
R2	7030005671	S.RES ERA3YKD 393V (39K)	B	33.4/11.6
R3	7030008051	S.RES ERA3YKD 184V (180K)	B	42.6/6.4
R4	7030005050	S.RES ERJ2GEJ 103 X (10K)	B	40.9/6.8
R5	7030005050	S.RES ERJ2GEJ 103 X (10K)	B	40.9/7.7
R51	7030008141	S.RES ERA3YKD 224V (220K)	B	49.7/10.8
R52	7030007911	S.RES ERA3YKD 563V (56K)	B	48.5/10.8
R53	7030006561	S.RES ERA3YED 223V (22K)	B	46.5/11.8
R54	7030005050	S.RES ERJ2GEJ 334 X (10K)	B	47.9/8.4
R55	7030005050	S.RES ERJ2GEJ 103 X (10K)	B	48.8/8.4
R201	7030010040	S.RES ERJ2GEJ-JPW	B	109.6/38
R202	7030010040	S.RES ERJ2GEJ-JPW	B	109.6/39
R251	7030005120	S.RES ERJ2GEJ 102 X (1K)	B	136.5/49.6
R252	7030000300	S.RES MCR10EZHJ 220 (221)	B	133.9/47.3
R253	7030000300	S.RES MCR10EZHJ 220 (221)	B	141.3/51.5
R254	7030000300	S.RES MCR10EZHJ 220 (221)	B	133.9/49
R255	7030000300	S.RES MCR10EZHJ 220 (221)	T	142.6/51.4
R301	7030005120	S.RES ERJ2GEJ 102 X (1K)	B	113.2/32
R302	7030005050	S.RES ERJ2GEJ 103 X (10K)	T	114/30.4
R303	7030005120	S.RES ERJ2GEJ 102 X (1K)	B	111/33.4
R304	7030007300	S.RES ERJ2GEJ 332 X (3.3K)	B	111.9/33.4
R305	7030007300	S.RES ERJ2GEJ 332 X (3.3K)	B	113.2/32.9
R306	7030005120	S.RES ERJ2GEJ 102 X (1K)	T	114.9/11
R307	7030005050	S.RES ERJ2GEJ 103 X (10K)	B	111.3/8.4
R308	7030005230	S.RES ERJ2GEJ 334 X (330K)	B	113.8/5.3
R309	7030005310	S.RES ERJ2GEJ 124 X (120K)	B	112/5.3
R310	7030008010	S.RES ERJ2GEJ 123 X (12K)	B	110.2/5.3
R521	7030008370	S.RES ERJ2GEJ 103 X (560)	B	61.8/46.2
R522	7030010040	S.RES ERJ2GEJ-JPW	B	65.3/47.4
R523	7030010040	S.RES ERJ2GEJ-JPW	B	65.4/48.7
R524	7030010900	S.RES ERJ3GEYJ 750 V (75)	B	63.1/48.9
R528	7030010040	S.RES ERJ2GEJ-JPW	B	60.8/42.6
R529	7030005050	S.RES ERJ2GEJ 103 X (10K)	B	58.6/43.8
R530	7030005080	S.RES ERJ2GEJ 823 X (82K)	B	60.8/43.6
R531	7030009290	S.RES ERJ2GEJ 562 X (5.6K)	B	76.3/42.9
R532	7030005050	S.RES ERJ2GEJ 103 X (10K)	B	60.8/37.2
R533	7030010040	S.RES ERJ2GEJ-JPW	B	56.5/32.3
R534	7030010040	S.RES ERJ2GEJ-JPW	B	60.8/36
R536	7030010040	S.RES ERJ2GEJ-JPW	B	62.6/29
R537	7030010040	S.RES ERJ2GEJ-JPW	B	64.6/29
R538	7030010040	S.RES ERJ2GEJ-JPW	B	66.6/29
R539	7030005720	S.RES ERJ2GEJ 563 X (56K)	B	69.6/29
R540	7030010040	S.RES ERJ2GEJ-JPW	B	68.6/29
R541	7310004650	S.TRI EVM-2WSX80 B53 (502)	B	53.3/49.2
R544	7030010040	S.RES ERJ2GEJ-JPW	B	60.8/39.6
R545	7030005720	S.RES ERJ2GEJ 563 X (56K)	B	60.8/32
R546	7030010040	S.RES ERJ2GEJ-JPW	B	60.8/34
R547	7030010040	S.RES ERJ2GEJ-JPW	B	59.2/34.8
R548	7030010040	S.RES ERJ2GEJ-JPW	B	60.8/33
R549	7030010040	S.RES ERJ2GEJ-JPW	B	63.6/29
R550	7030010040	S.RES ERJ2GEJ-JPW	B	65.6/29
R551	7030010040	S.RES ERJ2GEJ-JPW	B	67.6/29
R553	7030010040	S.RES ERJ2GEJ-JPW	B	59.5/43.8
R601	7030008410	S.RES ERJ2GEJ 392 X (3.9K)	B	72.7/24.9
R602	7030008410	S.RES ERJ2GEJ 392 X (3.9K)	B	74.5/24.9

M.=Mounted side (T: Mounted on the Top side, B: Mounted on the Bottom side) S.=Surface mount

[DISPLAY UNIT]

REF NO.	PARTS NO.	DESCRIPTION	M.	H/V LOCATION
R603	7030008410	S.RES ERJ2GEJ 392 X (3.9K)	B	75.4/24.9
R604	7030008410	S.RES ERJ2GEJ 392 X (3.9K)	B	77.2/24.9
R605	7030008410	S.RES ERJ2GEJ 392 X (3.9K)	B	75.3/30.2
R606	7030008410	S.RES ERJ2GEJ 392 X (3.9K)	B	76.3/24.9
R608	7030010040	S.RES ERJ2GEJ-JPW	B	48.8/36.8
R609	7030005040	S.RES ERJ2GEJ 472 X (4.7K)	B	48.4/44.4
R610	7030010040	S.RES ERJ2GEJ-JPW	B	48.8/41.7
R612	7030005040	S.RES ERJ2GEJ 472 X (4.7K)	B	48.8/42.6
R613	7030003470	S.RES ERJ3GEYJ 182 V (1.8K)	B	52.6/46.1
R614	7030003470	S.RES ERJ3GEYJ 182 V (1.8K)	B	50.7/46.3
R651	7030005050	S.RES ERJ2GEJ 103 X (10K)	B	5.5/19.6
R652	7030005220	S.RES ERJ2GEJ 223 X (22K)	B	0.8/25.7
R653	7030005060	S.RES ERJ2GEJ 333 X (33K)	B	5.5/21.4
R654	7030005070	S.RES ERJ2GEJ 683 X (68K)	B	0.8/25.7
R655	7030005090	S.RES ERJ2GEJ 104 X (100K)	B	4.1/30.7
R656	7030005110	S.RES ERJ2GEJ 224 X (22K)	B	0.8/27.4
R657	7030005060	S.RES ERJ2GEJ 333 X (33K)	B	1.8/30.3
R658	7030005090	S.RES ERJ2GEJ 104 X (100K)	B	4.1/29.8
R659	7030003600	S.RES ERJ3GEYJ 223 V (22K)	B	8.4/28.5
R660	7030005720	S.RES ERJ2GEJ 563 X (56K)	B	13.2/29.9
R661	7030005220	S.RES ERJ2GEJ 223 X (22K)	B	13.7/27.1
R662	7030007350	S.RES ERJ2GEJ 393 X (39K)	B	13.7/28.7
R663	7030005220	S.RES ERJ2GEJ 223 X (22K)	B	13.2/20.6
R664	7030007340	S.RES ERJ2GEJ 153 X (15K)	B	5.7/29.8
R665	7030003600	S.RES ERJ3GEYJ 223 V (22K)	B	8.9/20.6
R666	7030004980	S.RES ERJ2GEJ 101 X (100)	B	13.1/25.3
R667	7030004980	S.RES ERJ2GEJ 101 X (100)	B	11.1/18.8
R668	7030004980	S.RES ERJ2GEJ 101 X (100)	B	9.7/24.2
R669	7030004980	S.RES ERJ2GEJ 101 X (100)	B	13.6/16.2
R701	7030004990	S.RES ERJ2GEJ 221 X (220)	T	18.4/48
R702	7030007280	S.RES ERJ2GEJ 331 X (330)	T	19.7/48
R703	7030007290	S.RES ERJ2GEJ 222 X (2.2K)	T	25.1/41
R704	7030005040	S.RES ERJ2GEJ 472 X (4.7K)	T	16.6/17.2
R705	7030007340	S.RES ERJ2GEJ 153 X (15K)	T	18.7/6.4
R721	7030004990	S.RES ERJ2GEJ 221 X (220)	T	20.2/6.2
R722	7030007280	S.RES ERJ2GEJ 331 X (330)	T	23.8/5.6
R723	7030003480	S.RES ERJ3GEYJ 222 V (2.2K)	T	47.5/2.4
R724	7030003520	S.RES ERJ3GEYJ 472 V (4.7K)	T	61.8/2.4
R725	7030003580	S.RES ERJ3GEYJ 153 V (15K)	T	75.9/2.4
R741	7030004990	S.RES ERJ2GEJ 221 X (220)	T	92.7/49.7
R742	7030007280	S.RES ERJ2GEJ 331 X (330)	T	95.7/49.6
R743	7030007290	S.RES ERJ2GEJ 222 X (2.2K)	T	102.1/35
R744	7030005040	S.RES ERJ2GEJ 472 X (4.7K)	T	102.1/25.5
R745	7030007340	S.RES ERJ2GEJ 153 X (15K)	T	100.6/8.6
R761	7030004990	S.RES ERJ2GEJ 221 X (220)	T	103.1/48.2
R762	7030007280	S.RES ERJ2GEJ 331 X (330)	T	104.8/47.8
R771	7030004990	S.RES ERJ2GEJ 221 X (220)	T	18.7/28.9
R772	7030007280	S.RES ERJ2GEJ 331 X (330)	T	18.1/29.9
R781	7030004990	S.RES ERJ2GEJ 221 X (220)	T	3.5/22.4
R782	7030007280	S.RES ERJ2GEJ 331 X (330)	T	3.5/24.2
R801	7030005240	S.RES ERJ2GEJ 473 X (47K)	B	62/21.8
R802	7030007270	S.RES ERJ2GEJ 151 X (150)	B	62/20
R803	7030005120	S.RES ERJ2GEJ 102 X (1K)	B	62/23.6
R2002	7030005240	S.RES ERJ2GEJ 473 X (47K)	T	110.4/40.7
R2003	7030005050	S.RES ERJ2GEJ 103 X (10K)	T	24.6/24.1
R2004	7030005050	S.RES ERJ2GEJ 103 X (10K)	T	24.6/26.3
R2005	7030005050	S.RES ERJ2GEJ 103 X (10K)	T	24.6/23.2
R2006	7030005050	S.RES ERJ2GEJ 103 X (10K)	T	24.6/25.3
R2007	7030007290	S.RES ERJ2GEJ 222 X (2.2K)	T	107.6/24.4
R2008	7030005220	S.RES ERJ2GEJ 223 X (22K)	B	78.2/18.4
R2009	7030005240	S.RES ERJ2GEJ 473 X (47K)	T	107.8/33
R2010	7030005090	S.RES ERJ2GEJ 104 X (100K)	B	79.6/16.9
R2011	7030005160	S.RES ERJ2GEJ 105 X (1M)	B	103.3/26.9
R2012	7030008010	S.RES ERJ2GEJ 123 X (12K)	B	103.3/23.3
R2013	7030005240	S.RES ERJ2GEJ 473 X (47K)	B	96.7/37.9
R2014	7030005290	S.RES ERJ2GEJ 682 X (6.8K)	T	22.1/41
R2015	7030005050	S.RES ERJ2GEJ 103 X (10K)	B	106/44.6
R2016	7030005240	S.RES ERJ2GEJ 473 X (47K)	B	92.1/37.9
R2017	7030005290	S.RES ERJ2GEJ 682 X (6.8K)	T	33.4/3.7
R2018	7030005290	S.RES ERJ2GEJ 682 X (6.8K)	T	102.2/41.8
R2019	7030005240	S.RES ERJ2GEJ 473 X (47K)	B	84.8/33.8
R2020	7030003450	S.RES ERJ3GEYJ 122 V (1.2K)	B	91.2/43.1
R2021	7030005240	S.RES ERJ2GEJ 473 X (47K)	B	97.1/40.8
R2022	7030005240	S.RES ERJ2GEJ 473 X (47K)	B	92.3/42.3
R2023	7030005240	S.RES ERJ2GEJ 473 X (47K)	B	100.1/42.8
R2024	7030005240	S.RES ERJ2GEJ 473 X (47K)	B	94.3/42.3
R2025	7030005240	S.RES ERJ2GEJ 473 X (47K)	B	93.3/42.3
R2026	7030005240	S.RES ERJ2GEJ 473 X (47K)	B	72.4/16.7
R2027	7030005240	S.RES ERJ2GEJ 473 X (47K)	B	70.6/16.9
R2028	7030005240	S.RES ERJ2GEJ 473 X (47K)	B	98.9/42.8
R2029	7030005240	S.RES ERJ2GEJ 473 X (47K)	B	73.5/16.7
R2030	7030007270	S.RES ERJ2GEJ 151 X (150)	T	108/11.8
R2031	7030007280	S.RES ERJ2GEJ 331 X (330)	T	108.8/40.1
R2033	7030007270	S.RES ERJ2GEJ 151 X (150)	T	19.4/20.3
R2034	7030005120	S.RES ERJ2GEJ 102 X (1K)	B	32.1/28.3
R2035	7030005120	S.RES ERJ2GEJ 102 X (1K)	B	32.5/30.9
R2036	7030005240	S.RES ERJ2GEJ 473 X (47K)	B	94.9/37.9
R2037	7030005240	S.RES ERJ2GEJ 473 X (47K)	B	93.9/37.9
R2039	7030005240	S.RES ERJ2GEJ 473 X (47K)	T	107.6/23.5
R2040	7030007340	S.RES ERJ2GEJ 153 X (15K)	B	116.3/7.8
R2041	7030007340	S.RES ERJ2GEJ 153 X (15K)	B	116.2/7.7
R2042	7030005050	S.RES ERJ2GEJ 103 X (10K)	B	79.7/31.3
R2043	7030005090	S.RES ERJ2GEJ 104 X (100K)	B	81.9/30.4
C2	4030018960	S.CER C3216 JB 1C 106MT-N	B	62.2/7
C3	4030018960	S.CER C3216 JB 1C 106MT-N	B	77/9.8

[DISPLAY UNIT]

REF NO.	PARTS NO.	DESCRIPTION	M.	H/V LOCATION
C4	4030017420	S.CER ECJ0EC1H470J	B	35.3/10.6
C6	4030018960	S.CER C3216 JB 1C 106MT-N	B	28/6
C8	4030018960	S.CER C3216 JB 1C 106MT-N	B	30.1/6
C9	4030018960	S.CER C3216 JB 1C 106MT-N	B	39.1/4.4
C51	4030017420	S.CER ECJ0EC1H470J	B	49.7/8.4
C53	4030018960	S.CER C3216 JB 1C 106MT-N	B	51.6/4.3
C55	4030018960	S.CER C3216 JB 1C 106MT-N	B	56.2/11
C56	4030018960	S.CER C3216 JB 1C 106MT-N	B	61.9/3.6
C57	4030017490	S.CER C1608 JB 1A 105K-T	B	43.9/11.8
C101	4030018960	S.CER C3216 JB 1C 106MT-N	B	85.7/6.3
C102	4030018960	S.CER C3216 JB 1C 106MT-N	B	94.7/4.6
C103	4030016930	S.CER ECJ0EB1A104K	B	91.1/12.2
C104	4030016930	S.CER ECJ0EB1A104K	B	89.5/12.2
C151	4550006250	S.TAN TEESVA 1A 106M8R	B	97/4.6
C152	4550006250	S.TAN TEESVA 1A 106M8R	B	100.7/7.7
C153	4030016930	S.CER ECJ0EB1A104K	B	99.7/2.6
C154	4030016930	S.CER ECJ0EB1A104K	B	96.6/9.3
C251	4030017730	S.CER ECJ0EB1E471K	B	147.5/46.4
C252	4030017730	S.CER ECJ0EB1E471K	B	146.5/48.3
C253	4030017730	S.CER ECJ0EB1E471K	B	144.7/48.3
C254	4030017730	S.CER ECJ0EB1E471K	B	144.4/46.4
C255	4030017490	S.CER C1608 JB 1A 105K-T	T	148.9/51
C256	4030017490	S.CER C1608 JB 1A 105K-T	B	134.1/45.7
C301	4030017780	S.CER ECJ0EB1E472K	T	108.3/19.9
C302	4030017780	S.CER ECJ0EB1E472K	T	108.2/28.7
C303	4030006880	S.CER C1608 JB 1H 472K-T	T	113/27
C304	4030017780	S.CER ECJ0EB1E472K	B	113.2/33.8
C305	4030017780	S.CER ECJ0EB1E472K	T	114.9/12.6
C306	4030017780	S.CER ECJ0EB1E472K	B	113.8/4.3
C312	4030017780	S.CER ECJ0EB1E472K	T	108.2/29.6
C315	4030017780	S.CER ECJ0EB1E472K	B	25.2/19.9
C316	4030017780	S.CER ECJ0EB1E472K	B	26.1/19.9
C317	4030017780	S.CER ECJ0EB1E472K	B	27/19.9
C318	4030017780	S.CER ECJ0EB1E472K	B	23.9/19.8
C319	4030017780	S.CER ECJ0EB1E472K	B	27.2/32.5
C320	4030017780	S.CER ECJ0EB1E472K	B	26.3/32.5
C321	4030017780	S.CER ECJ0EB1E472K	B	25.5/31.1
C322	4030017780	S.CER ECJ0EB1E472K	T	24.6/27.3
C501	4550007140	S.TAN TEESVD 1C 107M12R	B	53.3/20.9
C502	4550007140	S.TAN TEESVD 1C 107M12R	B	45.3/20.9
C513	4030016930	S.CER ECJ0EB1A104K	B	64.3/47.4
C514	4030016930	S.CER ECJ0EB1A104K	B	63.3/47.4
C515	4030017490	S.CER C1608 JB 1A 105K-T	B	61.5/44.9
C516	4030018910	S.CER C1608 JB 0J 475K-T	B	67.7/48.9
C517	4030017490	S.CER C1608 JB 1A 105K-T	B	75.6/47.9
C518	4030017650	S.CER ECJ0EC1H270J	[EUR]	73.4/47.4
	4030017650	S.CER ECJ0EC1H270J	[FRA]	
	4030017650	S.CER ECJ0EC1H270J	[ESP]	
	4030017670	S.CER ECJ0EC1H390J	[USA]	
	4030017650	S.CER ECJ0EC1H270J	[EXP]	
	4030017650	S.CER ECJ0EC1H270J	[ITR]	
	4030017650	S.CER ECJ0EC1H270J	[UK]	
	4030017670	S.CER ECJ0EC1H390J	[KOR]	
	4030017650	S.CER ECJ0EC1H270J	[AUS]	
	4030017650	S.CER ECJ0EC1H270J	[CHN]	
C519	4030016930	S.CER ECJ0EB1A104K	B	76.9/48.4
C520	4030016930	S.CER ECJ0EB1A104K	B	74.4/47.4
C521	4030018960	S.CER C3216 JB 1C 106MT-N	B	65.6/20.6
C522	4030016930	S.CER ECJ0EB1A104K	B	69.7/19.8
C523	4030018970	S.CER C3225 JB 1C 226MT-N	B	53.4/28.9
C524	4030017700	S.CER ECJ0EC1H151J	B	59/42.6
C525	4030016930	S.CER ECJ0EB1A104K	B	55.4/30.3
C526	4030018090	S.CER ECJ0EB1C822K	B	59.2/35.8
C527	4030018100	S.CER ECJ0EB1H681K	B	59/45.9
C528	4030017730	S.CER ECJ0EB1E471K	B	59/45
C529	4030018970	S.CER C3225 JB 1C 226MT-N	B	58.4/40
C530	4030016930	S.CER ECJ0EB1A104K	B	77.2/39.1
C531	4030018970	S.CER C3225 JB 1C 226MT-N	B	81.3/35.9
C532	4030016930	S.CER ECJ0EB1A104K	B	77.2/36.6
C533	4030017490	S.CER C1608 JB 1A 105K-T	B	77/44.5
C534	4030016970	S.CER ECJ0EB1C223K	B	77.5/42.5
C536	4610001850	S.TRI TZB4R200AB10R00 (TZB4R200BA110)	B	81/39.7
C537	4030016930	S.CER ECJ0EB1A104K	B	77.2/40.1
C538	4030016930	S.CER ECJ0EB1A104K	B	77.2/37.6
C539	4030018910	S.CER C1608 JB 0J 475K-T	B	77.7/34.9
C540	4030018910	S.CER C1608 JB 0J 475K-T	B	58.5/37
C541	4030018970	S.CER C3225 JB 1C 226MT-N	B	59.2/28.9
C542	4030018910	S.CER C1608 JB 0J 475K-T	B	77.7/33.6
C543	4030018960	S.CER C3216 JB 1C 106MT-N	B	80/46.5
C544	4030018910	S.CER C1608 JB 0J 475K-T	B	77.7/32.3
C545	4030011600	S.CER C1608 JB 1E 104K-T	B	77/46.3
C549	4030018960	S.CER C3216 JB 1C 106MT-N	B	71.7/28.8
C550	4030018960	S.CER C3216 JB 1C 106MT-N	B	77/28.8
C551	4030018960	S.CER C3216 JB 1C 106MT-N	B	73.8/28.8
C559	4030017460	S.CER ECJ0EB1E102K	B	29.3/43.9
C560	4030018960	S.CER C3216 JB 1C 106MT-N	B	17/33.2
C561	4030017330	S.CER ECJ0EB1C104Z	B	7.3/30.7
C562	4030017780	S.CER ECJ0EB1E472K	B	6.1/30.9
C601	4030016930	S.CER ECJ0EB1A104K	B	

[DISPLAY UNIT]

REF NO.	PARTS NO.	DESCRIPTION	M.	H/V LOCATION
C609	4030011600	S.CER C1608 JB 1E 104K-T	B	50.6/31.7
C610	4030018960	S.CER C3216 JB 1C 106MT-N	B	52.3/33.5
C611	4550007220	S.TAN F931A476MCMCMBMA	B	73.4/22.1
C651	4030018960	S.CER C3216 JB 1C 106MT-N	B	16.9/17.6
C652	4030018960	S.CER C3216 JB 1C 106MT-N	B	6.7/17.1
C653	4030011600	S.CER C1608 JB 1E 104K-T	B	15.7/19.3
C654	4030017490	S.CER C1608 JB 1A 105K-T	B	3.5/20.4
C655	4030016790	S.CER ECJ0EB1C103K	B	0.8/30.3
C656	4030019090	S.CER C2012 JB 1C 225M-T	B	7.8/25.5
C657	4030018520	S.CER C1608 JB 0J 225M-T	B	7/20.6
C658	4030017650	S.CER ECJ0EC1H270J	B	5.5/20.5
C659	4030017780	S.CER ECJ0EB1E472K	B	15.2/20.3
C701	4030018960	S.CER C3216 JB 1C 106MT-N	B	4.6/32.4
C702	4030018960	S.CER C3216 JB 1C 106MT-N	B	48.9/19
C801	4030016930	S.CER ECJ0EB1A104K	B	62.9/19.7
C802	4030011600	S.CER C1608 JB 1E 104K-T	B	21.5/48.5
C851	4030017780	S.CER ECJ0EB1E472K	B	32.1/23.9
C852	4030018960	S.CER C3216 JB 1C 106MT-N	B	40.3/15.8
C853	4030016930	S.CER ECJ0EB1A104K	B	43.1/27.5
C2001	4030018520	S.CER C1608 JB 0J 225M-T	B	78.5/16.7
C2002	4030017780	S.CER ECJ0EB1E472K	T	114.8/34.7
C2003	4030017630	S.CER ECJ0EC1H120J	B	103.3/28.7
C2004	4030017630	S.CER ECJ0EC1H120J	B	103.3/25.1
C2005	4030016790	S.CER ECJ0EB1C103K	B	103.2/34.9
C2006	4030016930	S.CER ECJ0EB1A104K	B	98/37.9
C2007	4030018960	S.CER C3216 JB 1C 106MT-N	B	105.8/47.7
C2008	4030017030	S.CER ECJ0EB1A273K	B	109.7/44.6
C2009	4030016930	S.CER ECJ0EB1A104K	B	99/37.9
C2010	4030016930	S.CER ECJ0EB1A104K	B	100/37.9
C2011	4030016930	S.CER ECJ0EB1A104K	B	78.7/29.9
C2012	4030017780	S.CER ECJ0EB1E472K	B	95.8/37.9
C2013	4030017780	S.CER ECJ0EB1E472K	B	93/37.9
C2014	4030016930	S.CER ECJ0EB1A104K	T	110.4/41.7
C2015	4030016930	S.CER ECJ0EB1A104K	B	103.1/35.8
C2016	4030016930	S.CER ECJ0EB1A104K	B	82.7/28.4
J202	6510023801	S.CON S4B-ZR-SM4A-TF(LF)(SN)	B	115.9/39.4
J251	6510025770	S.CON 03-935H0-72BKA	B	154.2/45.8
J303	6510021431	S.CON S8B-ZR-SM4A-TF(LF)(SN)	B	115.9/20.9
J401	6510024840	S.CON 52746-1070	B	21.3/26.3
J601	6510024780	S.CON 52437-2472	B	45.1/42
J2001	6510024790	S.CON 52559-1072	B	96.9/47.6
DS805	5040003190	S.LED NSSW008B	T	29.5/39.4
DS806	5040003190	S.LED NSSW008B	T	29.4/31.4
DS807	5040003190	S.LED NSSW008B	T	29.4/24.1
DS808	5040003190	S.LED NSSW008B	T	29.5/16.1
DS2001	5040002930	S.LED SML-512MW T86	T	110.2/15.8
DS2002	5040002020	S.LED CL-170UR-CD-T	T	110.2/36.8
DS2004	5040002930	S.LED SML-512MW T86	T	11.4/20.5
S201	2230001160	S.SWI SPVP110100	T	157.4/34.3
S251	2220000330	S.SWI HSW0880-01-210	B	139.7/46.5
S701	2230001150	S.SWI LS9J2M-1FG-T	T	22.2/48.3
S702	2230001150	S.SWI LS9J2M-1FG-T	T	21.7/36.5
S703	2230001150	S.SWI LS9J2M-1FG-T	T	20.9/17
S704	2230001150	S.SWI LS9J2M-1FG-T	T	21.6/2.7
S721	2230001150	S.SWI LS9J2M-1FG-T	T	40.1/2.4
S722	2230001150	S.SWI LS9J2M-1FG-T	T	54.3/2.4
S723	2230001150	S.SWI LS9J2M-1FG-T	T	68.4/2.4
S724	2230001150	S.SWI LS9J2M-1FG-T	T	82.6/2.4
S741	2230001150	S.SWI LS9J2M-1FG-T	T	98.1/47.8
S742	2230001150	S.SWI LS9J2M-1FG-T	T	99.1/32.1
S743	2230001150	S.SWI LS9J2M-1FG-T	T	99.1/20.5
S744	2230001150	S.SWI LS9J2M-1FG-T	T	98.1/5.7
S761	2230001150	S.SWI LS9J2M-1FG-T	T	109.5/49.1
S762	2230001150	S.SWI LS9J2M-1FG-T	T	109.5/3.5
S763	2230001150	S.SWI LS9J2M-1FG-T	T	154.8/47.4
S764	2230001150	S.SWI LS9J2M-1FG-T	T	154.8/5.1
S781	2230001150	S.SWI LS9J2M-1FG-T	T	4.6/29
S782	2230001150	S.SWI LS9J2M-1FG-T	T	21.7/25.8
EP1	6910014730	S.BEA MPZ2012S331A-T	B	64.1/6.6

[VR UNIT]

REF NO.	PARTS NO.	DESCRIPTION	M.	H/V LOCATION
R1	7210003230	VAR TP96D00A-17F-10KBX2-2427		
R2	7030003860	S.RES ERJ3GE JPW V	T	1.3/32.6
R3	7030003860	S.RES ERJ3GE JPW V	T	2.3/30
J1	6510024850	S.CON 54550-1094	T	3.3/22.2
S1	2250000170	ENC TP90D96AE20-17F (1352)		
EP4	6910012350	S.BEA MMZ1608Y 102BT	T	2.7/32.6
EP5	6910012350	S.BEA MMZ1608Y 102BT	T	3.7/30
EP6	6910012350	S.BEA MMZ1608Y 102BT	T	.9/30
EP7	6910012350	S.BEA MMZ1608Y 102BT	T	.9/14.5
EP8	6910012350	S.BEA MMZ1608Y 102BT	T	3.7/14.5
EP9	6910012350	S.BEA MMZ1608Y 102BT	T	2.7/11.8
EP10	6910012350	S.BEA MMZ1608Y 102BT	T	2.3/14.5
EP11	6910012350	S.BEA MMZ1608Y 102BT	T	1.3/11.8

M.=Mounted side (T: Mounted on the Top side, B: Mounted on the Bottom side)
S.=Surface mount

[LOGIC UNIT]

REF NO.	PARTS NO.	DESCRIPTION	M.	H/V LOCATION
IC1	1130013281	S.IC TC58FVM6T5BTG65GCH (SX2427D-6)	T	27.9/30.2
IC2	1130011151	S.IC SN74AHC2G08HDCT3	B	40.2/38.2
IC3	1130011151	S.IC SN74AHC2G08HDCT3	B	40.6/32.4
IC4	1130012600	S.IC SN74AHC1G04DCKR	B	43.6/33.8
IC51	1130012842	S.IC CY7C1021DV33-10BVXIT	B	24.5/28.5
IC301	1140012541	S.IC ADSP-BF532SBBCZ400	B	28.6/39.2
IC401	1110004770	S.IC BU9480F-E2	B	17.4/21.6
IC451	1110006570	S.IC TS462CPT	B	29.1/7.9
IC452	1110006570	S.IC TS462CPT	T	39.1/8.5
IC502	1110006570	S.IC TS462CPT	T	30.7/5.4
IC551	1190001611	S.IC AK4528VFP-E2/P	T	17.9/8.1
IC601	1110006570	S.IC TS462CPT	B	12.7/10.8
IC701	1130012600	S.IC SN74AHC1G04DCKR	B	2.7/15.9
IC1201	1130012791	S.IC CY22150FZXCT	B	44.5/4.5
IC1212	1140012170	S.IC BH7236AF-E2	T	57.7/7.3
IC1217	1130007181	S.IC TC7WU04FU(TE12L,F)	B	63.4/9.8
IC1218	1130012761	S.IC SN74AHC2G86HDCT3	B	52.7/6.5
IC1226	1130010871	S.IC S1D13706F00A200	B	53.7/19.8
IC1251	1180002020	S.REG BA0033FP-E2	T	79.5/5.2
IC1301	1130012691	S.IC R1EX24256ASA00A	T	81.4/36.2
IC1302	1140013137	S.IC HD6432375A23FQV(SX-2427B-7)	T	54.9/25.2
IC1303	1110005771	S.IC S-80942CNMC-G9CT2G	T	81.2/10.4
IC1304	1130011551	S.IC RX-4581NB-F	B	71.9/7.2
IC1402	1130012781	S.IC SN74AHC2G04HDCT3	T	79.1/18.9
IC2002	1130012842	S.IC CY7C1021DV33-10BVXIT	B	32.7/28.3
IC2101	1130012850	S.IC SN74LVC3G34DCUR	T	44.5/44.7
IC2102	1130012850	S.IC SN74LVC3G34DCUR	T	44.4/41.2
IC2201	1140012541	S.IC ADSP-BF532SBBCZ400	B	28.6/17.7
Q201	1550000110	S.FET RTQ035P02TR	B	18.9/42.7
Q1101	1530002060	S.TRA 2SC4081 T106 R	T	82.1/20.3
Q1102	1590003940	S.TRA RN1105(TE85L,F)	T	81.8/22.7
Q1103	1510000510	S.TRA 2SA1576A T106R	T	81.8/16.4
Q1201	1590003940	S.TRA RN1105(TE85L,F)	T	44.8/13.2
D201	1750001280	S.DIO CUS02(TE85L,Q)	B	19.2/45.3
D1001	1750000370	S.DIO DA221 TL	B	64.5/36.8
D1002	1750000370	S.DIO DA221 TL	B	64.9/34.5
D1101	1790001250	S.DIO MA2S111-(TX)	T	81.9/18.4
D1106	1750000950	S.DIO MA732(TX)	T	80.1/29.6
D1107	1790001670	S.DIO RB706F-40T106	T	82.4/31.3
D1110	1790001670	S.DIO RB706F-40T106	T	75.7/32.3
D1111	1790001670	S.DIO RB706F-40T106	T	75.3/29.3
D1112	1790001670	S.DIO RB706F-40T106	B	79.2/29.1
D1113	1790001670	S.DIO RB706F-40T106	B	82.3/30.6
D1201	1790001250	S.DIO MA2S111-(TX)	B	83/40.4
D1301	1790000660	S.DIO MA728(TX)	B	77.5/2.9
D1304	1750000370	S.DIO DA221 TL	T	76.1/19.9
D1305	1750000370	S.DIO DA221 TL	T	75.8/16.8
D1306	1750000370	S.DIO DA221 TL	B	49.3/32.9
D1307	1750000370	S.DIO DA221 TL	B	51.4/33.3
D1311	1790001250	S.DIO MA2S111-(TX)	B	80.9/19.6
D1312	1790001250	S.DIO MA2S111-(TX)	B	83.1/18.5
D1313	1790001250	S.DIO MA2S111-(TX)	B	80/22.6
D1314	1790001240	S.DIO MA2S728-(TX)	B	81.7/22.4
D1331	1790001250	S.DIO MA2S111-(TX)	B	65.6/17.5
X1201	6050012150	S.XTA CR-806 SMD-49TA 4.433619 MHz [EUR]	B	61.3/3.1
	6050012150	S.XTA CR-806 SMD-49TA 4.433619 MHz [FRA]		
	6050012150	S.XTA CR-806 SMD-49TA 4.433619 MHz [ESP]		
	6050012140	S.XTA CR-805 SMD-49TA 3.579545 MHz [USA]		
	6050012150	S.XTA CR-806 SMD-49TA 4.433619 MHz [EXP]		
	6050012150	S.XTA CR-806 SMD-49TA 4.433619 MHz [ITR]		
	6050012150	S.XTA CR-806 SMD-49TA 4.433619 MHz [UK]		
	6050012140	S.XTA CR-805 SMD-49TA 3.579545 MHz [KOR]		
	6050012150	S.XTA CR-806 SMD-49TA 4.433619 MHz [AUS]		
	6050012150	S.XTA CR-806 SMD-49TA 4.433619 MHz [CHN]		
X1301	6050012190	S.XTA CR-809 SMD-49TA 1539744 MHz	B	60.4/30.8
L201	6200011900	S.COI LQH43CN100K03L	T	16/41.9
L202	6200009491	S.COI CDRH6D28NP-100NC	B	13.3/42.3
L551	6200005011	S.COI NLV25T-100J	T	11.2/10.5
L552	6200005011	S.COI NLV25T-100J	T	11.1/5.8
L1202	6200002041	S.COI NLV25T-101J	B	52.3/2.3
L1203	6200002041	S.COI NLV25T-101J	B	66.7/3.5
L1204	6200002041	S.COI NLV25T-101J	B	57.9/10.3
L2101	6200005011	S.COI NLV25T-100J	T	40.9/4.5
L2102	6200005011	S.COI NLV25T-100J	T	40.2/41.5
R2	7030005090	S.RES ERJ2GEJ 104 X (100K)	T	39.5/30.1
R3	7030005090	S.RES ERJ2GEJ 104 X (100K)	T	39.5/32.3

[LOGIC UNIT]

REF NO.	PARTS NO.	DESCRIPTION	M.	H/V LOCATION
R4	7030005090	S.RES ERJ2GEJ 104 X (100K)	T	31.8/45.8
R5	7030005090	S.RES ERJ2GEJ 104 X (100K)	T	30.9/45.8
R6	7030005090	S.RES ERJ2GEJ 104 X (100K)	T	30/45.8
R203	7030000010	S.RES MCR10EZHZ JPW (000)	T	20.7/45.6
R301	7030004980	S.RES ERJ2GEJ 101 X (100)	T	25.4/45.8
R302	7030005050	S.RES ERJ2GEJ 103 X (10K)	T	26.9/45.8
R303	7030005050	S.RES ERJ2GEJ 103 X (10K)	T	27.8/45.8
R306	7030005050	S.RES ERJ2GEJ 103 X (10K)	B	38.1/31.1
R307	7030005050	S.RES ERJ2GEJ 103 X (10K)	T	22/41.4
R308	7030005050	S.RES ERJ2GEJ 103 X (10K)	T	22/40.5
R310	7030005050	S.RES ERJ2GEJ 103 X (10K)	B	35.3/38
R312	7030010040	S.RES ERJ2GEJ-JPW	B	33.6/45.9
R313	7030010040	S.RES ERJ2GEJ-JPW	B	35.6/43.3
R314	7030010040	S.RES ERJ2GEJ-JPW	B	35.6/40.6
R413	7030004980	S.RES ERJ2GEJ 101 X (100)	B	18.1/16.8
R414	7030004980	S.RES ERJ2GEJ 101 X (100)	T	16.3/19.9
R415	7030004980	S.RES ERJ2GEJ 101 X (100)	B	19/16.8
R416	7030004980	S.RES ERJ2GEJ 101 X (100)	B	17.2/16.8
R462	7030004980	S.RES ERJ2GEJ 101 X (100)	B	33.8/7.4
R463	7030004980	S.RES ERJ2GEJ 101 X (100)	T	43.6/8.8
R464	7030004980	S.RES ERJ2GEJ 101 X (100)	B	26.2/5.7
R465	7030009270	S.RES ERJ2GEJ 821 X (820)	B	28.6/5.2
R467	7030004980	S.RES ERJ2GEJ 101 X (100)	B	31.3/4.3
R469	7030009270	S.RES ERJ2GEJ 821 X (820)	B	30.4/4.3
R470	7030009140	S.RES ERJ2GEJ 272 X (2.7K)	T	29.4/3
R471	7030009140	S.RES ERJ2GEJ 272 X (2.7K)	T	34/3.3
R472	7030005040	S.RES ERJ2GEJ 472 X (4.7K)	T	38.6/5.0
R473	7030005040	S.RES ERJ2GEJ 472 X (4.7K)	T	38.6/3.2
R474	7030009140	S.RES ERJ2GEJ 272 X (2.7K)	B	24.8/7.1
R475	7030009140	S.RES ERJ2GEJ 272 X (2.7K)	B	33.8/9.2
R476	7030005040	S.RES ERJ2GEJ 472 X (4.7K)	T	40.2/3.3
R507	7030004980	S.RES ERJ2GEJ 101 X (100)	T	26/3.5
R508	7030004980	S.RES ERJ2GEJ 101 X (100)	T	31.6/8.9
R510	7030005040	S.RES ERJ2GEJ 472 X (4.7K)	T	32.5/8.9
R511	7030005040	S.RES ERJ2GEJ 472 X (4.7K)	T	28.9/8.9
R512	7030004980	S.RES ERJ2GEJ 101 X (100)	T	29.8/8.9
R514	7030005050	S.RES ERJ2GEJ 103 X (10K)	T	34.9/8.8
R515	7030005050	S.RES ERJ2GEJ 103 X (10K)	T	34.9/7.9
R516	7030005040	S.RES ERJ2GEJ 472 X (4.7K)	T	39/12.8
R517	7030005040	S.RES ERJ2GEJ 472 X (4.7K)	T	36.5/11
R518	7030009140	S.RES ERJ2GEJ 272 X (2.7K)	T	36.4/5.6
R519	7030009140	S.RES ERJ2GEJ 272 X (2.7K)	T	26.4/5.6
R520	7030005040	S.RES ERJ2GEJ 472 X (4.7K)	T	41.3/12.8
R551	7030004980	S.RES ERJ2GEJ 101 X (100)	T	16.5/13.4
R553	7030004980	S.RES ERJ2GEJ 101 X (100)	T	14.7/13.4
R554	7030005090	S.RES ERJ2GEJ 104 X (100K)	T	15.4/3.2
R568	7030004980	S.RES ERJ2GEJ 101 X (100)	T	12.9/13.4
R569	7030004980	S.RES ERJ2GEJ 101 X (100)	T	15.6/13.4
R570	7030004980	S.RES ERJ2GEJ 101 X (100)	T	13.8/13.4
R571	7030009320	S.RES ERJ2GEJ 4R7 X (4.7)	B	20.7/8.4
R601	7030004980	S.RES ERJ2GEJ 101 X (100)	T	3/12.3
R602	7030007300	S.RES ERJ2GEJ 332 X (3.3K)	T	11.8/8.4
R603	7030005040	S.RES ERJ2GEJ 472 X (4.7K)	B	12.3/4.8
R604	7030005040	S.RES ERJ2GEJ 472 X (4.7K)	B	13.2/4.8
R605	7030007300	S.RES ERJ2GEJ 332 X (3.3K)	B	14.4/5.1
R606	7030007300	S.RES ERJ2GEJ 332 X (3.3K)	B	12.8/7.2
R607	7030005290	S.RES ERJ2GEJ 682 X (6.8K)	B	13.8/7.2
R608	7030005290	S.RES ERJ2GEJ 682 X (6.8K)	B	14.8/6.4
R609	7030005040	S.RES ERJ2GEJ 472 X (4.7K)	T	10.9/8.4
R610	7030005040	S.RES ERJ2GEJ 472 X (4.7K)	B	8.9/4.2
R611	7030005040	S.RES ERJ2GEJ 472 X (4.7K)	B	9.8/4.2
R612	7030007300	S.RES ERJ2GEJ 332 X (3.3K)	B	11.4/5.6
R613	7030007300	S.RES ERJ2GEJ 332 X (3.3K)	B	8.8/6.9
R614	7030005290	S.RES ERJ2GEJ 682 X (6.8K)	B	9.7/6.9
R615	7030005290	S.RES ERJ2GEJ 682 X (6.8K)	B	10.6/6.9
R618	7030005120	S.RES ERJ2GEJ 102 X (1K)	B	14.4/4.2
R619	7030005120	S.RES ERJ2GEJ 102 X (1K)	B	10.7/4.2
R701	7030005050	S.RES ERJ2GEJ 103 X (10K)	B	4.6/22.8
R702	7030005050	S.RES ERJ2GEJ 103 X (10K)	B	4.6/23.7
R703	7030005050	S.RES ERJ2GEJ 103 X (10K)	B	4.5/25.9
R705	7030005120	S.RES ERJ2GEJ 102 X (1K)	B	5/21
R706	7030005050	S.RES ERJ2GEJ 103 X (10K)	B	4.4/17.1
R707	7030007250	S.RES ERJ2GEJ 220 X (22)	B	4.4/15.5
R1001	7030005120	S.RES ERJ2GEJ 102 X (1K)	B	70.8/37
R1002	7030005050	S.RES ERJ2GEJ 103 X (10K)	B	65.9/32.3
R1003	7030005160	S.RES ERJ2GEJ 105 X (1M)	B	70.4/35.8
R1004	7030005240	S.RES ERJ2GEJ 473 X (47K)	B	66.1/18.5
R1006	7030005120	S.RES ERJ2GEJ 102 X (1K)	B	52/34.8
R1007	7030005120	S.RES ERJ2GEJ 102 X (1K)	B	53.2/32
R1008	7030005120	S.RES ERJ2GEJ 102 X (1K)	B	75.1/20.4
R1010	7030005240	S.RES ERJ2GEJ 473 X (47K)	B	76.7/19.8
R1012	7030005000	S.RES ERJ2GEJ 471 X (470)	B	66.5/33.9
R1013	7030005000	S.RES ERJ2GEJ 471 X (470)	B	66.5/36.4
R1015	7030005240	S.RES ERJ2GEJ 473 X (47K)	B	50.4/34.8
R1016	7030005240	S.RES ERJ2GEJ 473 X (47K)	B	51/31.7
R1018	7030007340	S.RES ERJ2GEJ 153 X (15K)	B	63.3/34.4
R1019	7030007340	S.RES ERJ2GEJ 153 X (15K)	B	62.9/36.1
R1101	7030008290	S.RES ERJ2GEJ 183 X (18K)	T	80.1/15.4
R1102	7030008010	S.RES ERJ2GEJ 123 X (12K)	T	79.9/21.9
R1103	7030005120	S.RES ERJ2GEJ 102 X (1K)	T	79.9/22.8
R1104	7030005120	S.RES ERJ2GEJ 102 X (1K)</		

[LOGIC UNIT]

REF NO.	PARTS NO.	DESCRIPTION	M.	H/V LOCATION
R1111	7030005090	S.RES ERJ2GEJ 104 X (100K)	T	77.4/14.8
R1113	7030007290	S.RES ERJ2GEJ 222 X (2.2K)	T	83.2/29.3
R1114	7030007300	S.RES ERJ2GEJ 332 X (3.3K)	T	82.3/29.3
R1115	7030005120	S.RES ERJ2GEJ 102 X (1K)	T	76.8/26.3
R1116	7030005120	S.RES ERJ2GEJ 102 X (1K)	T	76.9/28.1
R1117	7030005120	S.RES ERJ2GEJ 102 X (1K)	B	82.7/22.2
R1118	7030007300	S.RES ERJ2GEJ 332 X (3.3K)	B	83/23.8
R1119	7030007300	S.RES ERJ2GEJ 332 X (3.3K)	B	83.8/22.2
R1120	7030005120	S.RES ERJ2GEJ 102 X (1K)	B	84.1/23.8
R1123	7030005160	S.RES ERJ2GEJ 105 X (1M)	B	66.9/24.4
R1124	7030005120	S.RES ERJ2GEJ 102 X (1K)	B	82/20
R1126	7030005160	S.RES ERJ2GEJ 105 X (1M)	B	66.9/23.5
R1127	7030010040	S.RES ERJ2GEJ-JPW	T	73.7/18.5
R1128	7030005120	S.RES ERJ2GEJ 102 X (1K)	B	83.2/20.1
R1129	7030007300	S.RES ERJ2GEJ 332 X (3.3K)	B	81.9/28.4
R1131	7030005090	S.RES ERJ2GEJ 104 X (100K)	B	78.5/26.1
R1132	7030005090	S.RES ERJ2GEJ 104 X (100K)	B	81.4/24.4
R1201	7030005160	S.RES ERJ2GEJ 105 X (1M)	B	62.7/7.6
R1202	7030005050	S.RES ERJ2GEJ 103 X (10K)	B	49.2/7.5
R1203	7030005050	S.RES ERJ2GEJ 103 X (10K)	B	49.2/8.4
R1204	7030005050	S.RES ERJ2GEJ 103 X (10K)	B	49.7/9.6
R1205	7030010040	S.RES ERJ2GEJ-JPW	B	49.2/3.1
R1206	7030007570	S.RES ERJ2GEJ 122 X (1.2K)	B	46.1/9.6
R1207	7030007570	S.RES ERJ2GEJ 122 X (1.2K)	B	43.9/9.6
R1208	7030007570	S.RES ERJ2GEJ 122 X (1.2K)	B	43.5/11.4
R1209	7030009710	S.RES ERJ2GEJ 203 X (20K)	B	48.8/9.6
R1210	7030007350	S.RES ERJ2GEJ 393 X (39K)	B	47.9/9.6
R1211	7030005050	S.RES ERJ2GEJ 103 X (10K)	B	48.9/11.4
R1212	7030005050	S.RES ERJ2GEJ 103 X (10K)	B	48/11.4
R1213	7030005050	S.RES ERJ2GEJ 103 X (10K)	B	41.7/11.4
R1214	7030009710	S.RES ERJ2GEJ 203 X (20K)	B	46.2/11.4
R1215	7030007350	S.RES ERJ2GEJ 393 X (39K)	B	45.3/11.4
R1216	7030005050	S.RES ERJ2GEJ 103 X (10K)	B	44.7/12.6
R1217	7030005050	S.RES ERJ2GEJ 103 X (10K)	B	44.7/13.5
R1218	7030005050	S.RES ERJ2GEJ 103 X (10K)	B	44.7/14.4
R1219	7030005040	S.RES ERJ2GEJ 472 X (4.7K)	B	74.4/41.1
R1220	7030009710	S.RES ERJ2GEJ 203 X (20K)	B	44.7/15.3
R1221	7030005040	S.RES ERJ2GEJ 472 X (4.7K)	B	82.9/41.6
R1222	7030005040	S.RES ERJ2GEJ 472 X (4.7K)	B	74.4/40.2
R1223	7030005040	S.RES ERJ2GEJ 472 X (4.7K)	B	74.4/39.3
R1224	7030005040	S.RES ERJ2GEJ 472 X (4.7K)	B	80.9/39.3
R1225	7030005240	S.RES ERJ2GEJ 473 X (47K)	B	83.1/35.7
R1226	7030005240	S.RES ERJ2GEJ 473 X (47K)	B	74.4/37.5
R1227	7030005240	S.RES ERJ2GEJ 473 X (47K)	B	73.8/38.4
R1228	7030005240	S.RES ERJ2GEJ 473 X (47K)	B	82.2/35.7
R1229	7030007350	S.RES ERJ2GEJ 393 X (39K)	B	43.5/15.4
R1230	7030004970	S.RES ERJ2GEJ 470 X (47K)	B	49.2/2.2
R1231	7030005050	S.RES ERJ2GEJ 103 X (10K)	B	48.8/5.4
R1232	7030005220	S.RES ERJ2GEJ 223 X (22K)	B	40.3/3.2
R1235	7030007270	S.RES ERJ2GEJ 151 X (150)	T	66.2/5.9
R1236	7030007270	S.RES ERJ2GEJ 151 X (150)	T	66.2/7
R1237	7030007290	S.RES ERJ2GEJ 222 X (2.2K)	B	61.1/7.6
R1251	7030011250	S.RES ERJ1TY 390U (39)	T	70.3/6.4
R1301	7030005220	S.RES ERJ2GEJ 223 X (22K)	T	78.1/37.8
R1302	7030005050	S.RES ERJ2GEJ 103 X (10K)	T	78.1/36
R1303	7030005240	S.RES ERJ2GEJ 473 X (47K)	B	66/21.2
R1304	7030005240	S.RES ERJ2GEJ 473 X (47K)	B	66/20.3
R1305	7030009160	S.RES ERJ2GEJ 181 X (180)	T	68.5/25.9
R1306	7030005060	S.RES ERJ2GEJ 333 X (33K)	T	78.7/11.4
R1307	7030005040	S.RES ERJ2GEJ 472 X (4.7K)	T	68/21.9
R1308	7030005110	S.RES ERJ2GEJ 224 X (220K)	T	67.5/20
R1309	7030005110	S.RES ERJ2GEJ 224 X (220K)	T	69/19.4
R1310	7030005110	S.RES ERJ2GEJ 224 X (220K)	T	67.5/18.8
R1311	7030005110	S.RES ERJ2GEJ 224 X (220K)	T	69/18.2
R1312	7030005110	S.RES ERJ2GEJ 224 X (220K)	T	67.5/17.6
R1313	7030005110	S.RES ERJ2GEJ 224 X (220K)	T	69/17
R1314	7030005110	S.RES ERJ2GEJ 224 X (220K)	T	67.5/16.4
R1315	7030005110	S.RES ERJ2GEJ 224 X (220K)	T	69/15.8
R1316	7030005110	S.RES ERJ2GEJ 224 X (220K)	B	66.6/12.3
R1317	7030005110	S.RES ERJ2GEJ 224 X (220K)	B	65.7/12.3
R1318	7030005110	S.RES ERJ2GEJ 224 X (220K)	B	64.8/12.3
R1319	7030005110	S.RES ERJ2GEJ 224 X (220K)	B	63.9/12.3
R1320	7030005110	S.RES ERJ2GEJ 224 X (220K)	B	63/12.3
R1321	7030005110	S.RES ERJ2GEJ 224 X (220K)	B	62.1/12.3
R1322	7030005110	S.RES ERJ2GEJ 224 X (220K)	B	61.2/12.3
R1323	7030005110	S.RES ERJ2GEJ 224 X (220K)	B	60.3/12.1
R1324	7030005050	S.RES ERJ2GEJ 103 X (10K)	T	80.5/12.6
R1325	7030007350	S.RES ERJ2GEJ 393 X (39K)	T	78.1/9.8
R1326	7030005010	S.RES ERJ2GEJ 681 X (680)	B	78.9/2
R1327	7030005240	S.RES ERJ2GEJ 473 X (47K)	B	66/19.4
R1328	7030005050	S.RES ERJ2GEJ 103 X (10K)	B	75.9/6.4
R1329	7030005240	S.RES ERJ2GEJ 473 X (47K)	B	75.9/5
R1331	7030010040	S.RES ERJ2GEJ-JPW	B	75.9/3.2
R1332	7030005040	S.RES ERJ2GEJ 472 X (4.7K)	B	75.9/4.1
R1333	7030005110	S.RES ERJ2GEJ 224 X (220K)	T	67.4/26.9
R1334	7030005050	S.RES ERJ2GEJ 103 X (10K)	T	78.3/12.6
R1335	7030010040	S.RES ERJ2GEJ-JPW	B	78.5/5.1
R1337	7030005240	S.RES ERJ2GEJ 473 X (47K)	T	40.9/15.5
R1338	7030005240	S.RES ERJ2GEJ 473 X (47K)	T	40.9/16.4
R1339	7030007290	S.RES ERJ2GEJ 222 X (2.2K)	B	65.5/22.4
R1401	7030005240	S.RES ERJ2GEJ 473 X (47K)	B	62.7/24.2
R1402	7030005240	S.RES ERJ2GEJ 473 X (47K)	B	76.7/21.8
R1403	7030005240	S.RES ERJ2GEJ 473 X (47K)	B	78.3/22.1
R1404	7030005240	S.RES ERJ2GEJ 473 X (47K)	B	76.7/22.9
R1405	7030005240	S.RES ERJ2GEJ 473 X (47K)	T	50.7/12.9
R1406	7030005240	S.RES ERJ2GEJ 473 X (47K)	T	69/20.6
R1407	7030005240	S.RES ERJ2GEJ 473 X (47K)	T	41.7/33.4

[LOGIC UNIT]

REF NO.	PARTS NO.	DESCRIPTION	M.	H/V LOCATION
R1408	7030005240	S.RES ERJ2GEJ 473 X (47K)	B	76.7/25.3
R1409	7030005240	S.RES ERJ2GEJ 473 X (47K)	B	78.3/24.7
R1410	7030005240	S.RES ERJ2GEJ 473 X (47K)	B	78.3/23.5
R1411	7030005240	S.RES ERJ2GEJ 473 X (47K)	B	76.7/24.1
R1412	7030005240	S.RES ERJ2GEJ 473 X (47K)	B	43.6/24.7
R1413	7030005240	S.RES ERJ2GEJ 473 X (47K)	T	42.4/17.9
R1502	7030007300	S.RES ERJ2GEJ 332 X (3.3K)	B	80.9/28.4
R2101	7030005050	S.RES ERJ2GEJ 103 X (10K)	T	48.1/44.9
R2102	7030005050	S.RES ERJ2GEJ 103 X (10K)	T	47.7/42.7
R2103	7030005050	S.RES ERJ2GEJ 103 X (10K)	T	47.6/40.5
R2104	7030005050	S.RES ERJ2GEJ 103 X (10K)	T	47.7/43.7
R2105	7030005050	S.RES ERJ2GEJ 103 X (10K)	T	47.5/41.7
R2110	7030010040	S.RES ERJ2GEJ-JPW	B	21.4/22.5
R2112	7030005040	S.RES ERJ2GEJ 472 X (4.7K)	T	38.5/44.4
R2201	7030004980	S.RES ERJ2GEJ 101 X (100)	T	31.5/11.1
R2202	7030005050	S.RES ERJ2GEJ 103 X (10K)	T	30.6/11.1
R2203	7030005050	S.RES ERJ2GEJ 103 X (10K)	T	21.5/22.4
R2204	7030005050	S.RES ERJ2GEJ 103 X (10K)	T	35.2/15.5
R2205	7030005050	S.RES ERJ2GEJ 103 X (10K)	T	35.2/16.4
R2206	7030005050	S.RES ERJ2GEJ 103 X (10K)	T	21.5/21.5
R2214	7030005050	S.RES ERJ2GEJ 103 X (10K)	T	27.5/11.1
R2215	7030005050	S.RES ERJ2GEJ 103 X (10K)	T	28.4/11.1
R2216	7030010040	S.RES ERJ2GEJ-JPW	T	34.8/37.3
C1	4030016930	S.CER ECJ0EB1A104K	T	16.9/25.1
C2	4030016930	S.CER ECJ0EB1A104K	B	38.1/36
C3	4030016930	S.CER ECJ0EB1A104K	B	39.5/28.9
C4	4030016930	S.CER ECJ0EB1A104K	B	42.4/35.8
C5	4550007310	S.TAN F930J227MNMBSMA	T	40.8/23.4
C51	4030016930	S.CER ECJ0EB1A104K	B	19.2/27.4
C52	4030016930	S.CER ECJ0EB1A104K	B	19.2/28.3
C53	4550007310	S.TAN F930J227MNMBSMA	B	11.4/30.3
C54	4550007310	S.TAN F930J227MNMBSMA	T	7.1/8
C201	4030016930	S.CER ECJ0EB1A104K	B	19/40.2
C203	4030018960	S.CER C3216 JB 1C 106MT-N	T	18.8/45.5
C204	4030016930	S.CER ECJ0EB1A104K	T	11.9/40.2
C205	4030016930	S.CER ECJ0EB1A104K	T	11.9/41.8
C206	4030016930	S.CER ECJ0EB1A104K	B	8.8/43.4
C207	4030019460	S.CER C1608 JB 0J 106M-T	T	9.9/45
C302	4030016930	S.CER ECJ0EB1A104K	T	30.2/40.4
C303	4030016930	S.CER ECJ0EB1A104K	T	30.4/37.8
C304	4030016930	S.CER ECJ0EB1A104K	T	26.9/37.2
C305	4030016930	S.CER ECJ0EB1A104K	T	34.1/45.8
C306	4030016930	S.CER ECJ0EB1A104K	T	29.2/37.2
C307	4030016930	S.CER ECJ0EB1A104K	B	38.3/35
C308	4030016930	S.CER ECJ0EB1A104K	T	27.3/39.3
C309	4030016930	S.CER ECJ0EB1A104K	T	30.6/39.1
C310	4030016930	S.CER ECJ0EB1A104K	T	24.5/45.8
C311	4030016930	S.CER ECJ0EB1A104K	T	22/42.3
C312	4030016930	S.CER ECJ0EB1A104K	T	27.8/40.5
C313	4030016930	S.CER ECJ0EB1A104K	T	22/39.6
C314	4030016930	S.CER ECJ0EB1A104K	T	29.1/45.8
C315	4030016930	S.CER ECJ0EB1A104K	T	27.3/38.4
C316	4030016930	S.CER ECJ0EB1A104K	T	30.4/36.9
C317	4030016930	S.CER ECJ0EB1A104K	T	26.9/40.5
C318	4030016930	S.CER ECJ0EB1A104K	T	31.1/40.4
C319	4030016930	S.CER ECJ0EB1A104K	T	29.3/40.4
C320	4030016930	S.CER ECJ0EB1A104K	T	27.8/37.2
C413	4030018960	S.CER C3216 JB 1C 106MT-N	B	21.3/19.6
C414	4030016930	S.CER ECJ0EB1A104K	B	16.3/16.8
C415	4030018960	S.CER C3216 JB 1C 106MT-N	B	15.6/26.3
C461	4030016930	S.CER ECJ0EB1A104K	B	34.2/4.3
C462	4030018960	S.CER C3216 JB 1C 106MT-N	B	35.3/5.8
C463	4030018960	S.CER C3216 JB 1C 106MT-N	T	42/8.7
C464	4030016930	S.CER ECJ0EB1A104K	T	43.6/10.4
C465	4030017740	S.CER ECJ0EB1E821K	B	27.4/5.5
C466	4030017760	S.CER ECJ0EB1H222K	B	29.5/4.3
C467	4030017740	S.CER ECJ0EB1E821K	B	30.7/5.5
C468	4030018560	S.CER C2012 JB 1A 475K-T	T	31.8/2.6
C469	4030016930	S.CER ECJ0EB1A104K	B	24.8/8.7
C470	4030016930	S.CER ECJ0EB1A104K	B	33.8/8.3
C471	4030018560	S.CER C2012 JB 1A 475K-T	T	36.2/4.2
C472	4030018560	S.CER C2012 JB 1A 475K-T	T	36.2/5.2
C473	4030016930	S.CER ECJ0EB1A104K	T	40.2/4.2
C509	4030018960	S.CER C3216 JB 1C 106MT-N	T	24.2/5.5
C510	4030016930	S.CER ECJ0EB1A104K	T	26/4.4
C511	4030017760	S.CER ECJ0EB1H222K	T	30.7/8.9
C512	4030017690	S.CER ECJ0EC1H121J	T	32.1/7.7
C513	4030017690	S.CER ECJ0EC1H121J	T	29.4/7.7
C514	4030016930	S.CER ECJ0EB1A104K	T	36.4/6.5
C515	4030018860	S.CER ECJ0EB0J105K	T	36.5/9.2
C516	4030018860	S.CER ECJ0EB0J105K	T	36.5/8.3
C517	4030018860	S.CER ECJ0EB0J105K	T	36.5/10.1
C518	4030016930	S.CER ECJ0EB1A104K	T	26.1/6.8
C519	4030016930	S.CER ECJ0EB1A104K	T	41.3/11.9
C522	4030017780	S.CER ECJ0EB1E472K	B	38.9/9.8
C523	4030017780			

[LOGIC UNIT]

REF NO.	PARTS NO.	DESCRIPTION	M.	H/V LOCATION
C566	4030016930	S.CER ECJ0EB1A104K	T	19.4/3.2
C567	4030018960	S.CER C3216 JB 1C 106MT-N	B	21.3/12.3
C569	4030018960	S.CER C3216 JB 1C 106MT-N	B	19.2/12.3
C601	4030018960	S.CER C3216 JB 1C 106MT-N	B	3.7/12
C602	4030016930	S.CER ECJ0EB1A104K	T	3.9/10.9
C603	4030018820	S.CER ECJ0EB1H561K	B	13.4/6
C604	4510008640	S.ELE 6 CE 100 FE	B	4.8/6.7
C605	4030016930	S.CER ECJ0EB1A104K	T	10/8.4
C606	4030018580	S.CER C1608 CH 1H 821J-T	B	9.6/5.6
C607	4030017440	S.CER ECJ0EC1H221J	B	13.3/8.4
C608	4030017440	S.CER ECJ0EC1H221J	B	14.8/8
C609	4030018860	S.CER ECJ0EB0J105K	B	15.8/14.5
C610	4030010760	S.CER C1608 CH 1H 331J-T	B	9.6/8.3
C611	4030010760	S.CER C1608 CH 1H 331J-T	B	11.8/7.7
C612	4030018960	S.CER C3216 JB 1C 106MT-N	B	7.5/13.1
C613	4550006780	S.TAN TEESVB2 0J 476M8R	B	20.6/2.7
C614	4550006780	S.TAN TEESVB2 0J 476M8R	T	3.1/6.6
C651	4030017460	S.CER ECJ0EB1E102K	B	65.5/31.4
C652	4030017460	S.CER ECJ0EB1E102K	B	66/16.4
C653	4030017460	S.CER ECJ0EB1E102K	B	77.1/20.9
C654	4030017430	S.CER ECJ0EC1H101J	B	77.2/28.2
C655	4030017430	S.CER ECJ0EC1H101J	B	76.5/27.1
C656	4030017430	S.CER ECJ0EC1H101J	B	76.1/26.2
C701	4030016930	S.CER ECJ0EB1A104K	B	3/13.5
C702	4030017780	S.CER ECJ0EB1E472K	B	4.4/18.8
C703	4030017780	S.CER ECJ0EB1E472K	B	7.5/26.1
C704	4030017780	S.CER ECJ0EB1E472K	B	19.7/26.2
C705	4030017430	S.CER ECJ0EC1H101J	B	4.6/21.9
C706	4030017430	S.CER ECJ0EC1H101J	B	4.6/24.6
C707	4030017430	S.CER ECJ0EC1H101J	B	3.9/27.2
C708	4030017430	S.CER ECJ0EC1H101J	B	6.6/26.1
C709	4030017430	S.CER ECJ0EC1H101J	T	2.5/20.1
C711	4550007310	S.TAN F930J227MNMBA	T	5.5/18.9
C715	4030017460	S.CER ECJ0EB1E102K	T	2.2/17.6
C716	4030017460	S.CER ECJ0EB1E102K	T	2.2/18.6
C717	4030017460	S.CER ECJ0EB1E102K	T	2.2/16.6
C1001	4030017780	S.CER ECJ0EB1E472K	B	76.7/18.9
C1002	4030017780	S.CER ECJ0EB1E472K	B	70.4/38.2
C1101	4030017780	S.CER ECJ0EB1E472K	T	79.9/23.7
C1102	4030017780	S.CER ECJ0EB1E472K	T	73.6/20.7
C1103	4030016930	S.CER ECJ0EB1A104K	T	81.8/14.5
C1106	4030017780	S.CER ECJ0EB1E472K	T	79.7/31.9
C1107	4030018900	S.CER ECJ0EB0J474K	B	80.1/25.5
C1108	4030018900	S.CER ECJ0EB0J474K	B	81.4/25.4
C1109	4030017780	S.CER ECJ0EB1E472K	T	79.7/26.3
C1110	4030017780	S.CER ECJ0EB1E472K	T	80.7/26.3
C1111	4030017780	S.CER ECJ0EB1E472K	T	81.7/26.3
C1112	4030017780	S.CER ECJ0EB1E472K	B	82.9/28.4
C1201	4030016930	S.CER ECJ0EB1A104K	B	50.6/4.3
C1202	4030017780	S.CER ECJ0EB1E472K	B	53.2/4.3
C1203	4030017650	S.CER ECJ0EC1H270J	B	62.7/6.7
C1204	4030016930	S.CER ECJ0EB1A104K	B	47.9/8
C1205	4030016930	S.CER ECJ0EB1A104K	B	45.2/9.6
C1206	4030016930	S.CER ECJ0EB1A104K	B	43.5/13.8
C1207	4030017430	S.CER ECJ0EC1H101J	B	47/9.6
C1208	4030017430	S.CER ECJ0EC1H101J	B	43.9/8.7
C1209	4030017430	S.CER ECJ0EC1H101J	B	44.4/11.4
C1210	4030017650	S.CER ECJ0EC1H270J	B	61.1/6.7
C1211	4030018860	S.CER ECJ0EB0J105K	B	60.2/10.5
C1212	4030016930	S.CER ECJ0EB1A104K	B	49.7/4.3
C1213	4030016930	S.CER ECJ0EB1A104K	B	49.2/6.6
C1214	4030016930	S.CER ECJ0EB1A104K	B	40.3/4.8
C1215	4030016930	S.CER ECJ0EB1A104K	B	64.2/19.3
C1216	4030016930	S.CER ECJ0EB1A104K	B	53.7/30.3
C1217	4030016930	S.CER ECJ0EB1A104K	B	57.5/29.2
C1218	4030016930	S.CER ECJ0EB1A104K	B	44.8/23.9
C1219	4030016930	S.CER ECJ0EB1A104K	B	46.3/13.2
C1220	4030016930	S.CER ECJ0EB1A104K	B	56/8.8
C1221	4030016930	S.CER ECJ0EB1A104K	B	60.5/13.7
C1222	4030016930	S.CER ECJ0EB1A104K	B	60.9/25.6
C1223	4030016930	S.CER ECJ0EB1A104K	T	52.7/12.3
C1225	4030018960	S.CER C3216 JB 1C 106MT-N	T	66.7/10.2
C1251	4030012610	S.CER C2012 JB 1C 474K-T	T	73.4/9.3
C1252	4550007320	S.TAN F930J226MAABMA	T	73.4/4.4
C1301	4030016930	S.CER ECJ0EB1A104K	T	80.1/40.3
C1302	4030018960	S.CER C3216 JB 1C 106MT-N	T	47.9/11.4
C1303	4030016790	S.CER ECJ0EB1C103K	T	67.9/30.4
C1304	4030016930	S.CER ECJ0EB1A104K	T	41.7/31.5
C1305	4030018960	S.CER C3216 JB 1C 106MT-N	T	44.3/37.2
C1306	4030016790	S.CER ECJ0EB1C103K	T	64/37.5
C1307	4030016930	S.CER ECJ0EB1A104K	T	48.4/12.9
C1308	4030016930	S.CER ECJ0EB1A104K	T	63.1/13.1
C1309	4030016930	S.CER ECJ0EB1A104K	T	46.1/37.2
C1310	4030016930	S.CER ECJ0EB1A104K	T	67/30.9
C1311	4030016930	S.CER ECJ0EB1A104K	T	67/25.7
C1312	4030017620	S.CER ECJ0EC1H100C	T	67.4/29.1
C1313	4030017620	S.CER ECJ0EC1H100C	T	67.4/28.2
C1314	4030016930	S.CER ECJ0EB1A104K	T	79/9.8
C1315	4030017030	S.CER ECJ0EB1A273K	T	83.3/10.8
C1316	4030016930	S.CER ECJ0EB1A104K	B	75.9/2.3
C1317	4030018960	S.CER C3216 JB 1C 106MT-N	B	84.4/3
C1319	4030018960	S.CER C3216 JB 1C 106MT-N	B	16.8/6.6
C2016	4030016930	S.CER ECJ0EB1A104K	B	37.7/29.3
C2017	4030016930	S.CER ECJ0EB1A104K	B	37.7/30.2
C2101	4030016930	S.CER ECJ0EB1A104K	T	44/43
C2102	4030016930	S.CER ECJ0EB1A104K	T	45.8/43
C2202	4030016930	S.CER ECJ0EB1A104K	T	27/16.5

[LOGIC UNIT]

REF NO.	PARTS NO.	DESCRIPTION	M.	H/V LOCATION
C2204	4030016930	S.CER ECJ0EB1A104K	T	26.5/19.2
C2205	4030016930	S.CER ECJ0EB1A104K	T	30.2/19.7
C2206	4030016930	S.CER ECJ0EB1A104K	T	26.6/11.1
C2207	4030016930	S.CER ECJ0EB1A104K	T	27.7/19.7
C2208	4030016930	S.CER ECJ0EB1A104K	T	21.5/23.4
C2209	4030016930	S.CER ECJ0EB1A104K	T	29.8/17.6
C2210	4030016930	S.CER ECJ0EB1A104K	T	26.6/17.8
C2211	4030016930	S.CER ECJ0EB1A104K	T	32.4/11.1
C2212	4030016930	S.CER ECJ0EB1A104K	T	35.2/14.6
C2213	4030016930	S.CER ECJ0EB1A104K	T	29.3/16.4
C2214	4030016930	S.CER ECJ0EB1A104K	T	35.2/17.3
C2215	4030016930	S.CER ECJ0EB1A104K	T	29.3/11.1
C2217	4030016930	S.CER ECJ0EB1A104K	T	29.8/18.5
C2218	4030016930	S.CER ECJ0EB1A104K	T	26.5/20.1
C2219	4030016930	S.CER ECJ0EB1A104K	T	30.2/16.4
C2220	4030016930	S.CER ECJ0EB1A104K	T	26.1/16.5
C2221	4030016930	S.CER ECJ0EB1A104K	T	27.9/16.5
C2222	4030016930	S.CER ECJ0EB1A104K	T	29.3/19.7
J651	6510024811	S.CON AXK6S60637YG	B	71/24.9
J701	6510022071	S.CON AXK6S30637YG	B	10.9/20.4
J1201	6510018891	S.CON 52559-1370(1390)	B	77.5/38.2
J2101	6510020130	S.CON AXN810535P	T	52.4/42.9
BT1301	3020000330	LIT ML920S/F9D		
EP2	6910012350	S.BEA MMZ1608Y 102BT	T	18.8/38.2
EP51	6910012350	S.BEA MMZ1608Y 102BT	B	18.1/29.7
EP201	6910014730	S.BEA MPZ2012S331A-T	T	13.3/40.6
EP301	6910012350	S.BEA MMZ1608Y 102BT	T	19.1/40
EP701	6910012350	S.BEA MMZ1608Y 102BT	B	5.6/15.3
EP2002	6910012350	S.BEA MMZ1608Y 102BT	B	38.2/27.6
EP2202	6910012350	S.BEA MMZ1608Y 102BT	T	19.1/22
EP2205	6910014730	S.BEA MPZ2012S331A-T	T	18.4/17.7
EP2217	6910015970	S.BEA MMZ1608B 301CT-AS	B	20.9/16.1

[CONNECT UNIT]

REF NO.	PARTS NO.	DESCRIPTION	M.	H/V LOCATION
J1	6510019971	S.CON 52808-1071	T	7.1/11.8
W1	8900016410	CAB OPC-1579A		

M.=Mounted side (T: Mounted on the Top side, B: Mounted on the Bottom side)
S.=Surface mount

[DDS UNIT]

REF NO.	PARTS NO.	DESCRIPTION	M.	H/V LOCATION
IC51	1190001811	S.IC AD9833BRMZ-REEL7	T	38.7/3.5
IC52	1130012781	S.IC SN74AHC2G04HDC3	T	45/5.6
IC61	1130012610	S.IC SN74AHC1GU04DCKR	T	37.5/7.5
IC62	1130012850	S.IC SN74LVC3G34DCUR	T	51.3/24.7
IC251	1180002321	S.REG TK11218CMCL-G	B	29.5/16.2
IC301	1190002101	S.IC AD9951YSVZ	T	37.5/28.2
IC401	1110004080	S.IC UPC2709T-E3	T	50.1/47
IC451	1110006430	S.IC UPC1678GV-E1-A	T	34.1/50.2
IC801	1110006430	S.IC UPC1678GV-E1-A	T	18/13.7
IC901	1130012720	S.IC CD74HC4094PWR	T	5.4/64.7
Q1	1530002381	S.TRA 2SC4215-Y(TE85L,F)	T	20.4/3.1
Q101	1530002561	S.TRA 2SC4403-3-TL-E	T	26.5/6.4
Q151	1530003151	S.TRA 2SC4673D-TD-E	T	41.4/13.7
Q201	1530003432	S.TRA 2SC5226A-4-TL-E	T	43.4/19.4
Q211	1530003432	S.TRA 2SC5226A-4-TL-E	B	43.5/15.2
Q301	1590000680	S.TRA DTC114EUA T106	B	45.3/32.3
Q901	1590003930	S.TRA UMD22N TR	T	4/58.7
Q902	1590003930	S.TRA UMD22N TR	T	4.1/55.1
Q903	1590003930	S.TRA UMD22N TR	T	7.2/55.1
Q904	1590003930	S.TRA UMD22N TR	T	7.2/58.7
Q905	1590003930	S.TRA UMD22N TR	T	4.1/70.7
Q906	1590003930	S.TRA UMD22N TR	T	4.1/74.2
Q907	1590003930	S.TRA UMD22N TR	T	7.1/70.7
Q908	1590003930	S.TRA UMD22N TR	T	7.1/74.2
Q1101	1530002060	S.TRA 2SC4081 T106 R	T	40.9/53.9
Q1102	1540000451	S.TRA 2SD1623T-TD-E	T	45.5/54.3
D301	1750000620	S.DIO MA717WK(TX)	B	44.8/35.9
D341	1790001621	S.DIO 1SV308(TPL3,F)	B	45.2/39.7
D451	1750000581	S.DIO 1SV307(TPH3,F)	T	44.2/47.7
D452	1750000581	S.DIO 1SV307(TPH3,F)	T	44/44.8
D453	1790001621	S.DIO 1SV308(TPL3,F)	T	43.3/36.6
D454	1750000581	S.DIO 1SV307(TPH3,F)	T	38.3/48.3
D456	1750000620	S.DIO MA717WK(TX)	B	35.1/42.8
D458	1750000581	S.DIO 1SV307(TPH3,F)	T	33.8/45.6
D459	1750000581	S.DIO 1SV307(TPH3,F)	T	31.3/38.8
D471	1750000620	S.DIO MA717WK(TX)	B	33.2/36.6
D501	1750000581	S.DIO 1SV307(TPH3,F)	B	26.2/42.6
D502	1750000581	S.DIO 1SV307(TPH3,F)	T	3/50.6
D551	1750000581	S.DIO 1SV307(TPH3,F)	T	25.9/45.1
D552	1750000581	S.DIO 1SV307(TPH3,F)	T	2.9/45.3
D601	1750000581	S.DIO 1SV307(TPH3,F)	T	27.2/39.9
D602	1750000581	S.DIO 1SV307(TPH3,F)	T	2.9/40.1
D651	1750000581	S.DIO 1SV307(TPH3,F)	T	27.2/34.8
D652	1750000581	S.DIO 1SV307(TPH3,F)	T	2.9/34.9
D701	1750000581	S.DIO 1SV307(TPH3,F)	T	27.2/29.5
D702	1750000581	S.DIO 1SV307(TPH3,F)	T	2.9/29.7
D751	1750000581	S.DIO 1SV307(TPH3,F)	T	27/24.4
D752	1750000581	S.DIO 1SV307(TPH3,F)	T	2.9/24.6
D801	1750000581	S.DIO 1SV307(TPH3,F)	T	28.3/21.6
D802	1750000581	S.DIO 1SV307(TPH3,F)	T	2.9/19.3
D1101	1750000301	S.DIO 1SS302(TE85R,F)	T	40.9/57.7
D1102	1160000080	S.DIO DAP202K T146	B	27.9/63
FI101	2010002660	S.XTA DSF334SAF 124.032 MHz	T	29.3/10.7
FI201	2040001860	S.SAW NSVS776	T	34.5/16.5
X1	6050012800	S.XTA CR-788B VC-TXO 24.8064 MHz	T	13.8/3.7
L1	6200002641	S.COI NLV25T-R15J	T	26/3.7
L51	6200005011	S.COI NLV25T-100J	B	35.6/4.2
L52	6200005011	S.COI NLV25T-100J	B	38.8/3.8
L53	6200003241	S.COI NLV32T-221J	B	43.4/8.7
L54	6200009351	S.COI ELJRE R22GFA	T	34.6/8.6
L101	6200003540	S.COI MLF1608D R22K-T	T	24.2/8.8
L105	6200012650	S.COI MLF1608A 1R5J-T	T	23.7/5.2
L151	6200004470	S.COI MLF1608D R12K-T	T	44.7/12.8
L153	6200004150	S.COI MLF1608D 47NM-T	T	46.9/15.7
L201	6200004150	S.COI MLF1608D 47NM-T	T	44.5/21.5
L202	6200005661	S.COI ELJRE 10NGFA	B	37.5/12.4
L204	6200003540	S.COI MLF1608D R22K-T	T	41.5/19.3
L205	6200005711	S.COI ELJRE 27NGFA	B	47.1/21.7
L206	6200005701	S.COI ELJRE 22NGFA	B	46.2/20.4
L210	6200005701	S.COI ELJRE 22NGFA	B	47/19.1
L212	6200002581	S.COI NLV25T-033J	B	41.9/12.8
L213	6200005681	S.COI ELJRE 15NGFA	B	40.1/17.8
L301	6140002810	S.COI LR-317	T	48.5/30
L302	6140002810	S.COI LR-317	T	48.7/38.9
L303	6200004150	S.COI MLF1608D 47NM-T	B	41.9/35.7
L304	6200003960	S.COI MLF1608A 1R0K-T	T	50.4/33.2
	6200003960	S.COI MLF1608A 1R0K-T	[EUR]	
	6200003960	S.COI MLF1608A 1R0K-T	[FRA]	
	6200003960	S.COI MLF1608A 1R0K-T	[ESP]	
	6200003960	S.COI MLF1608A 1R0K-T	[USA]	
	6200003960	S.COI MLF1608A 1R0K-T	[EXP]	
	6200003960	S.COI MLF1608A 1R0K-T	[ITR]	
	6200003960	S.COI MLF1608A 1R0K-T	[UK]	
	6200003960	S.COI MLF1608A 1R0K-T	[KOR]	
	6200003960	S.COI MLF1608A 1R0K-T	[CHN]	
L321	6200009560	S.COI MLG1608B R10J-T	T	50.4/34.7
L322	6200011770	S.COI LQW18ANR10G00D	T	47.8/34.7
L323	6200005671	S.COI ELJRE 12NGFA	T	53.6/30.1

[DDS UNIT]

REF NO.	PARTS NO.	DESCRIPTION	M.	H/V LOCATION
L331	6200009680	S.COI MLG1608B 47NJ-T	T	47.6/43.1
L332	6200009680	S.COI MLG1608B 47NJ-T	T	50.2/43.1
L341	6200004470	S.COI MLF1608D R12K-T	B	41.1/37
L401	6200001981	S.COI NLV25T-1R0J	T	50.2/49.9
L411	6200009610	S.COI MLG1608B 39NJ-T	T	47.3/48.3
L456	6140002810	S.COI LR-317	T	40.1/24.9
L458	6200009680	S.COI MLG1608B 47NJ-T	B	37.5/42.1
L461	6200009660	S.COI MLG1608B 10NJ-T	B	39.3/41.7
L464	6200002631	S.COI NLV25T-R10J	T	28.8/50.6
L465	6200004470	S.COI MLF1608D R12K-T	T	42.9/39.5
L466	6200011580	S.COI LQW18AN33NG00D	T	39.1/41.1
L467	6200009670	S.COI MLG1608B 12NJ-T	T	27.7/47.1
L468	6200009590	S.COI MLG1608B 18NJ-T	T	26.1/48.3
L469	6200009580	S.COI MLG1608B 15NJ-T	T	33.6/41.3
L471	6140002810	S.COI LR-317	T	38.7/37.2
L472	6200009680	S.COI MLG1608B 47NJ-T	T	33.4/39.3
L473	6200009540	S.COI MLG1608B 22NJ-T	T	35.5/40.4
L501	6200002611	S.COI NLV25T-R47J	B	21.7/43.6
L502	6200002631	S.COI NLV25T-R10J	B	18.1/46.7
L503	6200002431	S.COI NLV25T-082J	B	15/46.4
L504	6200002411	S.COI NLV25T-056J	T	14.3/49.4
L505	6200002421	S.COI NLV25T-068J	T	11.2/50.2
L506	6200002421	S.COI NLV25T-068J	T	8.2/49.7
L507	6200002611	S.COI NLV25T-R47J	T	3.8/48.2
L551	6200002611	S.COI NLV25T-R47J	T	24.9/42.6
L552	6200002421	S.COI NLV25T-068J	T	20.3/43
L553	6200002411	S.COI NLV25T-056J	T	17.6/42.9
L554	6200002601	S.COI NLV25T-047J	T	14.7/45
L555	6200002601	S.COI NLV25T-047J	T	12/44.3
L556	6200002581	S.COI NLV25T-033J	T	9.2/45
L557	6200002611	S.COI NLV25T-R47J	T	4.5/42.8
L601	6200002611	S.COI NLV25T-R47J	T	25.3/37.4
L602	6200002601	S.COI NLV25T-047J	T	22.6/39.6
L603	6200002591	S.COI NLV25T-039J	T	19.7/39.1
L604	6200003891	S.COI NLV25T-027J	T	16.8/39.9
L605	6200002601	S.COI NLV25T-047J	T	14.1/37.9
L606	6200002601	S.COI NLV25T-047J	T	11.4/37.7
L607	6200002421	S.COI NLV25T-068J	T	8.6/37.7
L608	6200002601	S.COI NLV25T-047J	T	5.1/37.7
L651	6200002611	S.COI NLV25T-R47J	T	26/32.2
L652	6200002591	S.COI NLV25T-039J	T	22.4/32.5
L653	6200002591	S.COI NLV25T-039J	T	19.6/32.8
L654	6200002591	S.COI NLV25T-039J	T	14/34.6
L655	6200002591	S.COI NLV25T-039J	T	11.2/33.9
L656	6200002601	S.COI NLV25T-047J	T	16.7/32.5
L657	6200002581	S.COI NLV25T-033J	T	7.9/34.6
L658	6200002611	S.COI NLV25T-R47J	T	5.2/32.6
L701	6200002611	S.COI NLV25T-R47J	T	26/26.9
L702	6200002581	S.COI NLV25T-033J	T	22.9/29.2
L703	6200002581	S.COI NLV25T-033J	T	20.2/28.7
L704	6200003891	S.COI NLV25T-027J	T	17.3/29.5
L705	6200002591	S.COI NLV25T-039J	T	14.6/27.3
L706	6200002581	S.COI NLV25T-033J	T	11.8/27.3
L707	6200002581	S.COI NLV25T-033J	T	9.1/27.2
L708	6200002611	S.COI NLV25T-R47J	T	4.5/27.2
L751	6200002611	S.COI NLV25T-R47J	T	25.9/22
L752	6200003881	S.COI NLV25T-022J	T	22.4/22.4
L753	6200003891	S.COI NLV25T-027J	T	19.7/22.2
L754	6200002581	S.COI NLV25T-033J	T	16.9/22.5
L755	6200003891	S.COI NLV25T-027J	T	14.2/24.2
L756	6200003891	S.COI NLV25T-027J	T	11.4/23.5
L757	6200003881	S.COI NLV25T-022J	T	8.7/24.2
L758	6200002611	S.COI NLV25T-R47J	T	3.9/22.2
L801	6200002181	S.COI NLV25T-R12J	T	28.3/17.5
L803	6200005711	S.COI ELJRE 27NGFA	T	26.3/17.6
L804	6200009070	S.COI LQW18AN18NG00D		
L805	6200009220	S.COI LQW18AN15NG00D	T	25/15.6
		(LQW1608A18NG00)		
L806	6200005641	S.COI ELJRE 6N8ZFA	T	23.1/14.9
L807	6200009670	S.COI MLG1608B 12NJ-T	T	21.5/19
L808	6200004720	S.COI MLF1608D R10K-T	T	18.7/18.2
L812	6200005711	S.COI ELJRE 27NGFA	T	17.9/10
L813	6200009070	S.COI LQW18AN18NG00D	T	14.8/14.4
		(LQW1608A18NG00)		
L814	6200009220	S.COI LQW18AN15NG00D	T	15.7/17.2
		(LQW1608A15NG00)		
L815	6200005641	S.COI ELJRE 6N8ZFA	T	13.8/18.2
L816	6200010700	S.COI LQW18AN12NG00D	T	10.1/18
L818	6200002181	S.COI NLV25T-R12J	T	6.6/17.7
L851	6200002181	S.COI NLV25T-R12J	T	4.6/17
L852	6200002611	S.COI NLV25T-R47J	B	26.8/30.6
L853	6200002181	S.COI NLV25T-R12J	B	26.4/34.1
L854	6200002611	S.COI NLV25T-R47J	B	3.4/22.8
L901	6200007420	S.COI ELJFC 101K-F	B	5.4/26
L953	6200002041	S.COI NLV25T-101J	B	3.7/65.9
L954	6200002041	S.COI NLV25T-101J	B	56.4/44.6
L955	6200002041	S.COI NLV25T-101J	B	55.7/42.1
L956	6200002041	S.COI NLV25T-101J	B	55.9/39.6
L957	6200002041	S.COI NLV25T-101J	B	56.1/37.1
L959	6200011300	S.COI EXCML16A270U	B	55.9/34.6
L960	6200002041	S.COI NLV25T-101J	B	54.9/34.3
L962	6200011300	S.COI EXCML16A270U	B	56.6/30.3
L963	6200011300	S.COI EXCML16A270U	B	59.2/32.2
L1001	6200003241	S.COI NLV32T-221J	B	60.4/32.2
L1002	6200003241	S.COI NLV32T-221J	B	53.7/50.8
L1103	6200002041	S.COI NLV25T-101J	B	47.9/55

M.=Mounted side (T: Mounted on the Top side, B: Mounted on the Bottom side)
S.=Surface mount

[DDS UNIT]

REF NO.	PARTS NO.	DESCRIPTION	M.	H/V LOCATION
L1105	6200002041	S.COI NLV25T-101J	B	40.8/71.8
L1106	6200002041	S.COI NLV25T-101J	T	36.4/62.3
L1107	6200002041	S.COI NLV25T-101J	B	34.9/74.7
L1110	6200002041	S.COI NLV25T-101J	T	32.4/62.3
L1111	6200002041	S.COI NLV25T-101J	B	26.1/69.8
L1112	6200002041	S.COI NLV25T-101J	T	29.9/62.3
L1152	6200003590	S.COI EXCCL3225U1	T	48.3/69.2
L1153	6200002041	S.COI NLV25T-101J	T	45.5/69.3
L1154	6200002041	S.COI NLV25T-101J	T	53.6/69.2
R2	7030007290	S.RES ERJ2GEJ 222 X (2.2K)	T	19.1/4.5
R3	7030005040	S.RES ERJ2GEJ 472 X (4.7K)	T	18.6/1.8
R4	7030004990	S.RES ERJ2GEJ 221 X (220)	T	22.2/2.6
R5	7030004980	S.RES ERJ2GEJ 101 X (100)	T	20.9/6.9
R8	7030003630	S.RES ERJ3GEYJ 393 V (39K)	B	13.6/7.1
R9	7030003610	S.RES ERJ3GEYJ 273 V (27K)	B	13.6/9.7
R10	7030005060	S.RES ERJ2GEJ 333 X (33K)	T	8/3.2
R11	7030010040	S.RES ERJ2GEJ-JPW	T	9.2/3.7
R51	7030005120	S.RES ERJ2GEJ 102 X (1K)	T	35.7/9.5
R52	7030005120	S.RES ERJ2GEJ 102 X (1K)	T	46.1/2.3
R53	7030005120	S.RES ERJ2GEJ 102 X (1K)	T	42.8/3.5
R54	7030005120	S.RES ERJ2GEJ 102 X (1K)	T	42.8/2.6
R61	7030005050	S.RES ERJ2GEJ 103 X (10K)	T	39.3/8.1
R62	7030005530	S.RES ERJ2GEJ 100 X (10)	T	49.3/23.1
R101	7030005000	S.RES ERJ2GEJ 471 X (470)	T	25.2/7.8
R102	7030004980	S.RES ERJ2GEJ 101 X (100)	T	22.1/7.4
R103	7030005570	S.RES ERJ2GEJ 820 X (82)	T	31.8/11.1
R104	7030004980	S.RES ERJ2GEJ 101 X (100)	T	33/11.5
R105	7030005570	S.RES ERJ2GEJ 820 X (82)	T	34.2/11.2
R106	7030005100	S.RES ERJ2GEJ 154 X (150K)	T	23.9/7.4
R121	7030005040	S.RES ERJ2GEJ 472 X (4.7K)	T	38.5/11.1
R150	7030005570	S.RES ERJ2GEJ 820 X (82)	T	45.8/10.7
R151	7030004980	S.RES ERJ2GEJ 101 X (100)	T	44.9/10.7
R154	7030005050	S.RES ERJ2GEJ 103 X (10K)	T	41.4/10.6
R155	7030005530	S.RES ERJ2GEJ 100 X (10)	T	46.3/12.6
R157	7030007270	S.RES ERJ2GEJ 151 X (150)	T	48.8/18.2
R158	7030009200	S.RES ERJ2GEJ 390 X (39)	T	48/16.7
R159	7030007270	S.RES ERJ2GEJ 151 X (150)	T	47.9/18.2
R160	7030005300	S.RES ERJ2GEJ 150 X (15)	T	44.2/15.9
R161	7030004980	S.RES ERJ2GEJ 101 X (100)	T	45.1/15.9
R162	7030005300	S.RES ERJ2GEJ 150 X (15)	T	45/14.6
R201	7030005530	S.RES ERJ2GEJ 100 X (10)	T	45.8/22
R202	7030000700	S.RES MCR10EZHJ 470 K (474)	T	45.6/18.8
R211	7030003400	S.RES ERJ3GEYJ 471 V (470)	B	37.3/17.8
R212	7030003440	S.RES ERJ3GEYJ 102 V (1K)	B	40.8/16.2
R213	7030003200	S.RES ERJ3GEYJ 100 V (10)	B	44.5/11.4
R214	7030003280	S.RES ERJ3GEYJ 470 V (47)	B	46.8/16.3
R301	7030005120	S.RES ERJ2GEJ 102 X (1K)	T	34.2/22.2
R303	7030010040	S.RES ERJ2GEJ-JPW	T	40/22.2
R304	7030005120	S.RES ERJ2GEJ 102 X (1K)	T	42/24.6
R305	7030005710	S.RES ERJ2GEJ 121 X (120)	T	44.1/28.9
R306	7030005120	S.RES ERJ2GEJ 102 X (1K)	T	31.5/25.6
R309	7030005120	S.RES ERJ2GEJ 102 X (1K)	T	31.2/29.4
R310	7030005120	S.RES ERJ2GEJ 102 X (1K)	T	31.2/30.5
R311	7030005120	S.RES ERJ2GEJ 102 X (1K)	T	31.2/31.5
R312	7030010040	S.RES ERJ2GEJ-JPW	T	32.9/31.7
R313	7030005710	S.RES ERJ2GEJ 121 X (120)	T	43.2/28.5
R314	7030009140	S.RES ERJ2GEJ 272 X (2.7K)	T	43/31.8
R315	7030005120	S.RES ERJ2GEJ 102 X (1K)	T	33.5/32.6
R316	7030005050	S.RES ERJ2GEJ 103 X (10K)	T	34.6/33.8
R317	7030004990	S.RES ERJ2GEJ 221 X (220)	T	43.9/31.8
R318	7030003860	S.RES ERJ3GE JPW V [EUR]	B	35.8/28.4
	7030003860	S.RES ERJ3GE JPW V [FRA]		
	7030003860	S.RES ERJ3GE JPW V [ESP]		
	7030003860	S.RES ERJ3GE JPW V [USA]		
	7030003860	S.RES ERJ3GE JPW V [EXP]		
	7030003860	S.RES ERJ3GE JPW V [ITR]		
	7030003860	S.RES ERJ3GE JPW V [KOR]		
	7030003860	S.RES ERJ3GE JPW V [AUS]		
	7030003860	S.RES ERJ3GE JPW V [CHN]		
R341	7030003440	S.RES ERJ3GEYJ 102 V (1K)	B	44.3/38.3
R342	7030003440	S.RES ERJ3GEYJ 102 V (1K)	B	45.9/41.2
R451	7030005120	S.RES ERJ2GEJ 102 X (1K)	T	44.5/46.2
R452	7030003860	S.RES ERJ3GE JPW V	B	48.6/44.6
R453	7030010090	S.RES ERJ2GEJ 180 X (18)	T	34.1/47.4
R454	7030008280	S.RES ERJ2GEJ 271 X (270)	T	32.9/47
R455	7030008280	S.RES ERJ2GEJ 271 X (270)	T	32.9/47.9
R456	7030010040	S.RES ERJ2GEJ-JPW	T	34.9/52.4
R457	7030005120	S.RES ERJ2GEJ 102 X (1K)	T	38.1/49.7
R458	7030004990	S.RES ERJ2GEJ 221 X (220)	T	31.6/43.6
R459	7030005090	S.RES ERJ2GEJ 104 X (100K)	T	42.1/50
R460	7030003680	S.RES ERJ3GEYJ 104 V (100K)	T	30.7/41
R461	7030005090	S.RES ERJ2GEJ 104 X (100K)	T	29.6/39.1
R462	7030003860	S.RES ERJ3GE JPW V	T	45/43.3
R463	7030003400	S.RES ERJ3GEYJ 471 V (470)	T	33.3/44
R464	7030004980	S.RES ERJ2GEJ 101 X (100)	T	40.8/47.9
R465	7030005570	S.RES ERJ2GEJ 820 X (82)	T	40.3/50
R467	7030005570	S.RES ERJ2GEJ 820 X (82)	T	40.8/48.8
R468	7030005570	S.RES ERJ2GEJ 820 X (82)	T	41.2/50
R469	7030003320	S.RES ERJ3GEYJ 101 V (100)	B	37.7/39.9
R471	7030005000	S.RES ERJ2GEJ 471 X (470)	T	41.6/37.7
R472	7030004990	S.RES ERJ2GEJ 221 X (220)	T	30.3/43.3
R473	7030007270	S.RES ERJ2GEJ 151 X (150)	T	31.7/34.5
R474	7030009200	S.RES ERJ2GEJ 390 X (39)	T	31.3/35.7
R475	7030007270	S.RES ERJ2GEJ 151 X (150)	T	30.1/35.3
R476	7030005000	S.RES ERJ2GEJ 471 X (470)	T	29.9/37.9

[DDS UNIT]

REF NO.	PARTS NO.	DESCRIPTION	M.	H/V LOCATION
R477	7030003320	S.RES ERJ3GEYJ 101 V (100)	B	35.7/38.6
R501	7030003390	S.RES ERJ3GEYJ 391 V (390)	B	21/46.1
R502	7030009280	S.RES ERJ2GEJ 391 X	T	5.8/46.8
R503	7030005090	S.RES ERJ2GEJ 104 X (100K)	T	14.3/46.8
R505	7030005570	S.RES ERJ2GEJ 820 X (82)	T	6.5/48.6
R506	7030005570	S.RES ERJ2GEJ 820 X (82)	T	6/49.8
R507	7030005570	S.RES ERJ2GEJ 820 X (82)	T	5.6/48.6
R551	7030009280	S.RES ERJ2GEJ 391 X	T	23.1/42
R552	7030009280	S.RES ERJ2GEJ 391 X	T	6.3/42
R553	7030005090	S.RES ERJ2GEJ 104 X (100K)	T	10.1/41.6
R554	7030009200	S.RES ERJ2GEJ 390 X (39)	T	6.4/45.7
R555	7030007270	S.RES ERJ2GEJ 151 X (150)	T	7.1/44.4
R556	7030007270	S.RES ERJ2GEJ 151 X (150)	T	6.2/44.3
R601	7030008280	S.RES ERJ2GEJ 271 X (270)	T	23.2/36.1
R602	7030009280	S.RES ERJ2GEJ 391 X	T	6.8/36.6
R603	7030005090	S.RES ERJ2GEJ 104 X (100K)	T	19.6/36.4
R604	7030004980	S.RES ERJ2GEJ 101 X (100)	T	20.8/36.1
R651	7030009280	S.RES ERJ2GEJ 391 X	T	24.2/31.2
R652	7030009280	S.RES ERJ2GEJ 391 X	T	6.3/30.5
R653	7030005090	S.RES ERJ2GEJ 104 X (100K)	T	9.9/31.2
R701	7030009280	S.RES ERJ2GEJ 391 X	T	23.8/25.8
R702	7030009280	S.RES ERJ2GEJ 391 X	T	6.5/26
R703	7030005090	S.RES ERJ2GEJ 104 X (100K)	T	19.9/26
R704	7030004980	S.RES ERJ2GEJ 101 X (100)	T	7.2/27.2
R705	7030005710	S.RES ERJ2GEJ 121 X (120)	T	6.7/28.4
R706	7030004980	S.RES ERJ2GEJ 101 X (100)	T	6.3/27.2
R751	7030009280	S.RES ERJ2GEJ 391 X	T	24.2/21
R752	7030009280	S.RES ERJ2GEJ 391 X	T	5.9/20.8
R753	7030005090	S.RES ERJ2GEJ 104 X (100K)	T	10.3/20.8
R755	7030004980	S.RES ERJ2GEJ 101 X (100)	T	6.6/22.6
R756	7030005580	S.RES ERJ2GEJ 560 X (56)	T	6.6/24.2
R757	7030004980	S.RES ERJ2GEJ 101 X (100)	T	5.7/23.3
R801	7030008280	S.RES ERJ2GEJ 271 X (270)	T	27.2/14.5
R805	7030005570	S.RES ERJ2GEJ 820 X (82)	T	13.9/10.3
R806	7030005570	S.RES ERJ2GEJ 820 X (82)	T	14.2/11.7
R807	7030005570	S.RES ERJ2GEJ 820 X (82)	T	13/11.3
R808	7030003390	S.RES ERJ3GEYJ 391 V (390)	B	3.6/17.9
R810	7030005090	S.RES ERJ2GEJ 104 X (100K)	T	27.2/15.4
R841	7030005710	S.RES ERJ2GEJ 121 X (120)	T	21.2/12.5
R851	7030009280	S.RES ERJ2GEJ 391 X	T	27.1/37.3
R852	7030008280	S.RES ERJ2GEJ 271 X (270)	T	5.7/13.7
R853	7030010090	S.RES ERJ2GEJ 180 X (18)	T	6.9/14
R854	7030008280	S.RES ERJ2GEJ 271 X (270)	T	6.9/13
R855	7030003390	S.RES ERJ3GEYJ 391 V (390)	B	5.5/29.5
R901	7030005120	S.RES ERJ2GEJ 102 X (1K)	T	2.1/62.6
R902	7030005120	S.RES ERJ2GEJ 102 X (1K)	T	2.2/60.9
R903	7030005120	S.RES ERJ2GEJ 102 X (1K)	T	2.2/58.7
R951	7030003360	S.RES ERJ3GEYJ 221 V (220)	B	59.2/6.9
R952	7030004990	S.RES ERJ2GEJ 221 X (220)	T	54/9.3
R953	7030003360	S.RES ERJ3GEYJ 221 V (220)	B	59.5/3.3
R954	7030004990	S.RES ERJ2GEJ 221 X (220)	T	53.1/8.9
R955	7030004990	S.RES ERJ2GEJ 221 X (220)	T	55.2/7.7
R956	7030003360	S.RES ERJ3GEYJ 221 V (220)	B	59.2/4.9
R957	7030003360	S.RES ERJ3GEYJ 221 V (220)	B	56.6/5
R958	7030004990	S.RES ERJ2GEJ 221 X (220)	T	47.2/6.1
R959	7030003360	S.RES ERJ3GEYJ 221 V (220)	B	57.9/5.1
R960	7030003280	S.RES ERJ3GEYJ 470 V (47)	B	57.5/49
R961	7030004990	S.RES ERJ2GEJ 221 X (220)	T	54.6/11.6
R962	7030003860	S.RES ERJ3GE JPW V	T	51.3/21
R1051	7030003860	S.RES ERJ3GE JPW V	B	10.8/73
R1101	7030005120	S.RES ERJ2GEJ 102 X (1K)	T	40.5/52.1
R1102	7030005050	S.RES ERJ2GEJ 103 X (10K)	T	42.1/52.1
R1103	7030004980	S.RES ERJ2GEJ 101 X (100)	T	39.3/63.4
R1104	7030005050	S.RES ERJ2GEJ 103 X (10K)	T	44.2/51.2
R1105	7030004980	S.RES ERJ2GEJ 101 X (100)	T	38.7/60.9
R1106	7030007290	S.RES ERJ2GEJ 222 X (2.2K)	T	31.8/59.6
R1107	7030007290	S.RES ERJ2GEJ 222 X (2.2K)	T	28.1/59.6
R1108	7030005240	S.RES ERJ2GEJ 473 X (47K)	T	46.9/8.5
R1109	7030005240	S.RES ERJ2GEJ 473 X (47K)	T	47.9/8.5
C1	4030016950	S.CER ECJ0EB1A473K	T	17.5/4.5
C2	4030017780	S.CER ECJ0EB1E472K	T	20.9/5
C3	4030017510	S.CER ECJ0EC1H680J	T	24.8/1.7
C4	4030017780	S.CER ECJ0EB1E472K	T	22.3/4.6
C5	4030017680	S.CER ECJ0EC1H820J	T	26/2
C6	4030017510	S.CER ECJ0EC1H680J	T	27.2/1.7
C7	4030016930	S.CER ECJ0EB1A104K	T	8/4.1
C8	4030016790	S.CER ECJ0EB1C103K	T	10.1/5.7
C51	4030017780	S.CER ECJ0EB1E472K	T	33.8/6.5
C52	4030017780	S.CER ECJ0EB1E472K	T	36.1/5.3
C53	4030017780	S.CER ECJ0EB1E472K	T	36.9/4.4
C54	4030016930	S.CER ECJ0EB1A104K	T	34.9/4.4
C55	4510008580	S.ELE EEE0JA470SR	T	30.6/3.9
C56	4030016930	S.CER ECJ0EB1A104K	T	34.9/2.8
C57	4030016930	S.CER ECJ0EB1A104K	T	42.8/5
C58	4030016930	S.CER ECJ0EB1A104K	T	41/5.9
C59	4030017720	S.CER ECJ0EB1H331K	T	41.9/6.6
C60	4030017690	S.CER ECJ0EC1H121J	T	42.2/7.8
C61	4030017720	S.CER ECJ0EB1H331K	T	42.8/6.6
C62	4030016930	S.CER ECJ0EB1A104K	T	35.6/6.5
C63	4030016930	S.CER ECJ0EB1A104K	T	49.3/22.2
C64	4030017710	S.CER ECJ0EC1H181J	T	34.7/6.5
C65	4030017710	S.CER ECJ0EC1H181J	T	33.4/8.9
C101	4030017580	S.CER ECJ0EC1H060C	T	26.4/8.7
C102	4030017660	S.CER ECJ		

[DDS UNIT]

REF NO.	PARTS NO.	DESCRIPTION	M.	H/V LOCATION
C105	4030017460	S.CER ECJ0EB1E102K	T	24.8/6.5
C120	4030017780	S.CER ECJ0EB1E472K	T	37.3/11.5
C126	4030017780	S.CER ECJ0EB1E472K	T	23/7.4
C150	4030017780	S.CER ECJ0EB1E472K	T	44/10.7
C151	4030017780	S.CER ECJ0EB1E472K	T	46.3/13.6
C152	4030017640	S.CER ECJ0EC1H150J	T	43.3/16
C154	4030017660	S.CER ECJ0EC1H330J	T	46.6/14.6
C155	4030017600	S.CER ECJ0EC1H080C	T	46.4/16.7
C156	4030017660	S.CER ECJ0EC1H330J	T	47/18.2
C157	4030007090	S.CER C1608 CH 1H 470J-T	B	53/15.3
C202	4030017590	S.CER ECJ0EC1H070C	T	43.8/17.2
C203	4030007060	S.CER C1608 CH 1H 270J-T	B	37.8/15.9
C204	4030016930	S.CER ECJ0EB1A104K	T	35.1/20.1
C206	4030017560	S.CER ECJ0EC1H2R5B	T	43.4/21.7
C207	4030007110	S.CER C1608 CH 1H 680J-T	B	44/21.7
C208	4030009910	S.CER C1608 CH 1H 040B-T	B	40.9/21.7
C209	4030007060	S.CER C1608 CH 1H 270J-T	B	43.1/20.4
C210	4030009910	S.CER C1608 CH 1H 040B-T	B	40.8/19.8
C211	4030017460	S.CER ECJ0EB1E102K	T	42.2/17.6
C216	4030017780	S.CER ECJ0EB1E472K	T	46.3/20.8
C217	4030007120	S.CER C1608 CH 1H 820J-T	B	43.9/19.1
C218	4030011770	S.CER C1608 CH 1H 060B-T	B	43.2/17.8
C219	4030007010	S.CER C1608 CH 1H 100D-T	B	46.2/17.8
C221	4030006880	S.CER C1608 JB 1H 472K-T	B	46/15
C222	4030009910	S.CER C1608 CH 1H 040B-T	B	40.7/14.7
C223	4030006880	S.CER C1608 JB 1H 472K-T	B	46/13.4
C224	4030018630	S.CER C2012 CH 1H 472J-T	B	39.2/11.4
C225	4030006860	S.CER C1608 JB 1H 102K-T	B	38.4/19.4
C251	4030011600	S.CER C1608 JB 1E 104K-T	B	27.6/12.2
C252	4030011600	S.CER C1608 JB 1E 104K-T	B	28.7/23.5
C253	4550007090	S.TAN TEESVA 1A 226M8R	B	29.6/21.7
C254	4030011600	S.CER C1608 JB 1E 104K-T	B	29.2/12.2
C255	4550007090	S.TAN TEESVA 1A 226M8R	B	29.5/19.3
C302	4030016930	S.CER ECJ0EB1A104K	T	36.2/22.2
C303	4030016930	S.CER ECJ0EB1A104K	T	37.3/22.2
C304	4030016930	S.CER ECJ0EB1A104K	T	38.2/22.2
C305	4030016930	S.CER ECJ0EB1A104K	T	39.1/22.2
C306	4030016930	S.CER ECJ0EB1A104K	T	43.6/24.6
C307	4030016930	S.CER ECJ0EB1A104K	T	31.2/28.3
C308	4030016930	S.CER ECJ0EB1A104K	T	43.6/25.5
C309	4030016930	S.CER ECJ0EB1A104K	T	43/26.7
C310	4030016930	S.CER ECJ0EB1A104K	T	43.9/26.7
C312	4030016930	S.CER ECJ0EB1A104K	T	43.4/30.6
C317	4030011600	S.CER C1608 JB 1E 104K-T	B	44/26.1
C318	4030006880	S.CER C1608 JB 1H 472K-T	B	39.2/25.4
C321	4030017420	S.CER ECJ0EC1H470J	T	51.2/30.7
C323	4030017510	S.CER ECJ0EC1H680J	T	48.6/33.3
C325	4030017660	S.CER ECJ0EC1H330J	T	48.8/35.7
C326	4030017640	S.CER ECJ0EC1H150J	T	53.1/32
C328	4030006880	S.CER C1608 JB 1H 472K-T	[EUR] B	39.7/29.6
	4030006880	S.CER C1608 JB 1H 472K-T	[FRA]	
	4030006880	S.CER C1608 JB 1H 472K-T	[ESP]	
	4030006880	S.CER C1608 JB 1H 472K-T	[USA]	
	4030006880	S.CER C1608 JB 1H 472K-T	[EXP]	
	4030006880	S.CER C1608 JB 1H 472K-T	[ITR]	
	4030006880	S.CER C1608 JB 1H 472K-T	[KOR]	
	4030006880	S.CER C1608 JB 1H 472K-T	[AUS]	
	4030006880	S.CER C1608 JB 1H 472K-T	[CHN]	
C331	4030017390	S.CER ECJ0EC1H180J	T	46.6/44.5
C333	4030017670	S.CER ECJ0EC1H390J	T	48.4/44.5
C335	4030017390	S.CER ECJ0EC1H180J	T	50.2/44.5
C341	4030007130	S.CER C1608 CH 1H 101J-T	[EUR] B	42.5/39.7
	4030007130	S.CER C1608 CH 1H 101J-T	[FRA]	
	4030007130	S.CER C1608 CH 1H 101J-T	[ESP]	
	4030007130	S.CER C1608 CH 1H 101J-T	[USA]	
	4030007130	S.CER C1608 CH 1H 101J-T	[EXP]	
	4030007130	S.CER C1608 CH 1H 101J-T	[ITR]	
	4030007090	S.CER C1608 CH 1H 470J-T	[UK]	
	4030007130	S.CER C1608 CH 1H 101J-T	[KOR]	
	4030007130	S.CER C1608 CH 1H 101J-T	[AUS]	
	4030007130	S.CER C1608 CH 1H 101J-T	[CHN]	
C342	4030007090	S.CER C1608 CH 1H 470J-T	B	43.7/42.1
C343	4030007140	S.CER C1608 CH 1H 121J-T	B	41.3/39
C344	4030007100	S.CER C1608 CH 1H 560J-T	B	42.7/34.3
C345	4030017660	S.CER ECJ0EC1H330J	T	45.5/37.9
C346	4030017660	S.CER ECJ0EC1H330J	T	45.7/39.7
C347	4030006860	S.CER C1608 JB 1H 102K-T	[EUR] B	48.4/31.7
	4030006860	S.CER C1608 JB 1H 102K-T	[FRA]	
	4030006860	S.CER C1608 JB 1H 102K-T	[ESP]	
	4030006860	S.CER C1608 JB 1H 102K-T	[USA]	
	4030006860	S.CER C1608 JB 1H 102K-T	[EXP]	
	4030006860	S.CER C1608 JB 1H 102K-T	[ITR]	
	4030006860	S.CER C1608 JB 1H 102K-T	[KOR]	
	4030006860	S.CER C1608 JB 1H 102K-T	[AUS]	
	4030006860	S.CER C1608 JB 1H 102K-T	[CHN]	
C401	4030017460	S.CER ECJ0EB1E102K	T	51.1/44.5
C402	4030017460	S.CER ECJ0EB1E102K	T	52.3/48.9
C403	4030017430	S.CER ECJ0EC1H101J	T	47.9/46.1
C411	4030017400	S.CER ECJ0EC1H220J	T	48.1/49.7
C412	4030017630	S.CER ECJ0EC1H120J	T	47.7/47.3
C413	4030017400	S.CER ECJ0EC1H220J	T	46.7/49.4
C451	4030017420	S.CER ECJ0EC1H470J	T	40.2/40.6
C453	4030017460	S.CER ECJ0EB1E102K	T	46.1/46.8
C454	4030017460	S.CER ECJ0EB1E102K	T	35.3/47.9
C456	4030016930	S.CER ECJ0EB1A104K	T	31.2/48
C457	4030017460	S.CER ECJ0EB1E102K	T	35.3/47
C458	4030017460	S.CER ECJ0EB1E102K	T	30.5/49.8

[DDS UNIT]

REF NO.	PARTS NO.	DESCRIPTION	M.	H/V LOCATION
C459	4030017460	S.CER ECJ0EB1E102K	T	27/50.6
C460	4030017780	S.CER ECJ0EB1E472K	T	39.3/50
C461	4030006880	S.CER C1608 JB 1H 472K-T	T	30.7/42.2
C463	4030017420	S.CER ECJ0EC1H470J	T	40.6/41.8
C464	4030017690	S.CER ECJ0EC1H121J	T	41.5/40.2
C465	4030017400	S.CER ECJ0EC1H220J	T	37.7/41.8
C466	4030017570	S.CER ECJ0EC1H040B	T	38.1/40.6
C467	4030017400	S.CER ECJ0EC1H220J	T	37.2/40.6
C468	4030017360	S.CER ECJ0EC1H030B	T	29/48
C469	4030017370	S.CER ECJ0EC1H3R5B	T	29/47.1
C470	4030017380	S.CER ECJ0EC1H050B	T	29/46.2
C471	4030017380	S.CER ECJ0EC1H050B	T	35.6/43.9
C472	4030017660	S.CER ECJ0EC1H330J	T	34.7/41.8
C473	4030017570	S.CER ECJ0EC1H040B	T	34/43
C474	4030017460	S.CER ECJ0EB1E102K	T	41.6/36.7
C475	4030017460	S.CER ECJ0EB1E102K	T	30.5/36.7
C476	4030017780	S.CER ECJ0EB1E472K	T	29.6/40
C477	4030017780	S.CER ECJ0EB1E472K	T	42.4/48.8
C478	4030006880	S.CER C1608 JB 1H 472K-T	B	39.8/39.1
C479	4030006880	S.CER C1608 JB 1H 472K-T	B	38/37.9
C480	4030017630	S.CER ECJ0EC1H120J	T	35.6/41.8
C481	4030017360	S.CER ECJ0EC1H030B	T	35.6/43
C501	4030007080	S.CER C1608 CH 1H 390J-T	B	19/42.6
C502	4030007120	S.CER C1608 CH 1H 820J-T	B	18.3/44.1
C503	4030007060	S.CER C1608 CH 1H 270J-T	B	16.1/43.8
C504	4030017780	S.CER ECJ0EB1E472K	T	16.1/49.3
C505	4030017660	S.CER ECJ0EC1H330J	T	12.6/47.2
C506	4030017620	S.CER ECJ0EC1H100C	T	12.1/48.4
C507	4030017500	S.CER ECJ0EC1H560J	T	11.4/47.2
C508	4030017580	S.CER ECJ0EC1H060C	T	10.5/48.4
C509	4030017420	S.CER ECJ0EC1H470J	T	10.2/47.2
C510	4030017350	S.CER ECJ0EC1H020B	T	8.9/47.5
C511	4030017670	S.CER ECJ0EC1H390J	T	7.7/47.2
C512	4030017780	S.CER ECJ0EB1E472K	T	5.5/50.7
C513	4030017780	S.CER ECJ0EB1E472K	T	15.9/46.8
C551	4030017650	S.CER ECJ0EC1H270J	T	22.5/45.4
C552	4030017500	S.CER ECJ0EC1H560J	T	21.1/45
C553	4030017650	S.CER ECJ0EC1H270J	T	19.2/45.4
C554	4030017780	S.CER ECJ0EB1E472K	T	15.6/43.2
C555	4030017670	S.CER ECJ0EC1H390J	T	14.5/42
C556	4030017350	S.CER ECJ0EC1H020B	T	14/43.2
C557	4030017420	S.CER ECJ0EC1H470J	T	13.1/42
C558	4030017590	S.CER ECJ0EC1H070C	T	10/43.2
C559	4030017420	S.CER ECJ0EC1H470J	T	8.9/42
C560	4030017630	S.CER ECJ0EC1H120J	T	8.4/43.2
C561	4030017660	S.CER ECJ0EC1H330J	T	7.9/42
C562	4030017780	S.CER ECJ0EB1E472K	T	4.9/45.3
C563	4030017780	S.CER ECJ0EB1E472K	T	11.7/41.6
C601	4030017780	S.CER ECJ0EB1E472K	T	24.7/39.9
C602	4030017400	S.CER ECJ0EC1H220J	T	23.3/37.6
C603	4030017360	S.CER ECJ0EC1H030B	T	21.9/37.8
C604	4030017630	S.CER ECJ0EC1H120J	T	13.3/40.4
C605	4030017620	S.CER ECJ0EC1H100C	T	11.6/40.4
C606	4030017660	S.CER ECJ0EC1H330J	T	18.4/36.9
C607	4030017600	S.CER ECJ0EC1H080C	T	17.7/38.1
C608	4030017650	S.CER ECJ0EC1H270J	T	17.2/36.9
C609	4030017640	S.CER ECJ0EC1H150J	T	16.1/38.1
C610	4030017640	S.CER ECJ0EC1H150J	T	15.9/36.9
C611	4030017440	S.CER ECJ0EC1H215J	T	12.1/39.5
C612	4030017510	S.CER ECJ0EC1H680J	T	10.2/40
C613	4030017620	S.CER ECJ0EC1H100C	T	8.2/40.1
C614	4030017640	S.CER ECJ0EC1H150J	T	5.4/40.3
C615	4030017670	S.CER ECJ0EC1H390J	T	6.8/39.9
C616	4030017780	S.CER ECJ0EB1E472K	T	6.8/38.2
C617	4030017780	S.CER ECJ0EB1E472K	T	22/36.4
C618	4030017650	S.CER ECJ0EC1H270J	T	3.3/37.1
C651	4030017620	S.CER ECJ0EC1H100C	T	24.6/34.8
C652	4030017450	S.CER ECJ0EB1E271K	T	23.7/34.8
C653	4030017590	S.CER ECJ0EC1H070C	T	21.7/35.2
C654	4030017680	S.CER ECJ0EC1H820J	T	20.4/34.8
C655	4030017600	S.CER ECJ0EC1H080C	T	19.2/35.2
C656	4030017420	S.CER ECJ0EC1H470J	T	17.9/34.8
C657	4030017630	S.CER ECJ0EC1H120J	T	16.5/35.2
C658	4030017340	S.CER ECJ0EC1H010B	T	13.3/32.8
C659	4030017360	S.CER ECJ0EC1H030B	T	9.4/32.6
C660	4030017640	S.CER ECJ0EC1H150J	T	14.6/32.3
C661	4030017650	S.CER ECJ0EC1H270J	T	12.8/31.6
C662	4030017400	S.CER ECJ0EC1H220J	T	8.5/31.6
C663	4030017380	S.CER ECJ0EC1H050B	T	8/32.8
C664	4030017460	S.CER ECJ0EB1E102K	T	5.4/34.9
C665	4030017390	S.CER ECJ0EC1H180J	T	7.6/31.6
C666	4030017780	S.CER ECJ0EB1E472K	T	11.5/31.2
C701	4030017460	S.CER ECJ0EB1E102K	T	25/29.3
C702	4030017640	S.CER ECJ0EC1H150J	T	23.6/27.2
C703	4030017540	S.CER ECJ0EC1HR75B	T	22.2/27.4
C704	4030017650	S.CER ECJ0EC1H270J	T	18.7/26.4
C705	4030017350	S.CER ECJ0EC1H020B	T	18.2/27.7
C706	4030017400	S.CER ECJ0EC1H220J	T	17.5/26.4
C707	4030017570	S.CER ECJ0EC1H040B	T	16.6/27.7
C708	4030017390	S.CER ECJ0EC1H180J	T	16.3/26.4
C709	4030017590	S.CER ECJ0EC1H070C	T	13.9/30
C710	4030017500	S.CER ECJ0EC1H560J	T	12.5/29.1
C711	4030017380	S.CER ECJ0EC1H050B	T	11.9/30
C712	4030017500	S.CER EC		

[DDS UNIT]

REF NO.	PARTS NO.	DESCRIPTION	M.	H/V LOCATION
C716	4030017780	S.CER ECJ0EB1E472K	T	21.5/26
C717	4030017460	S.CER ECJ0EB1E102K	T	5.3/29.3
C751	4030017590	S.CER ECJ0EC1H070C	T	24.8/24.5
C752	4030017710	S.CER ECJ0EC1H181J	T	23.9/24.5
C753	4030017380	S.CER ECJ0EC1H050B	T	21.4/24.8
C754	4030017500	S.CER ECJ0EC1H560J	T	20.4/23.9
C755	4030017380	S.CER ECJ0EC1H050B	T	19.8/24.8
C756	4030017650	S.CER ECJ0EC1H270J	T	18.6/24.4
C757	4030017600	S.CER ECJ0EC1H080C	T	16.7/24.8
C758	4030017610	S.CER ECJ0EC1H090C	T	15/21.9
C759	4030017530	S.CER ECJ0EC1H0R5B	T	14.1/22.2
C760	4030017640	S.CER ECJ0EC1H150J	T	13.2/21.9
C761	4030017350	S.CER ECJ0EC1H020B	T	9.7/22.2
C762	4030017630	S.CER ECJ0EC1H120J	T	8.6/21.2
C763	4030017360	S.CER ECJ0EC1H030B	T	8.2/22.4
C764	4030017620	S.CER ECJ0EC1H100C	T	7.7/21.2
C765	4030017460	S.CER ECJ0EB1E102K	T	5.3/24.6
C766	4030017780	S.CER ECJ0EB1E472K	T	11.9/20.8
C802	4030017590	S.CER ECJ0EC1H070C	T	26.5/19.3
C803	4030017380	S.CER ECJ0EC1H050B	T	25.2/18.9
C804	4030017570	S.CER ECJ0EC1H040B	T	24.3/18.9
C806	4030017600	S.CER ECJ0EC1H080C	T	24.3/17.2
C807	4030017360	S.CER ECJ0EC1H030B	T	23.4/18.9
C808	4030017660	S.CER ECJ0EC1H330J	T	23/16.7
C809	4030017570	S.CER ECJ0EC1H040B	T	23/17.6
C810	4030017570	S.CER ECJ0EC1H040B	T	21.7/16.6
C811	4030017590	S.CER ECJ0EC1H070C	T	21.2/17.9
C812	4030017610	S.CER ECJ0EC1H090C	T	20.8/16.6
C813	4030017350	S.CER ECJ0EC1H020B	T	19.7/18.7
C814	4030017580	S.CER ECJ0EC1H060C	T	19.7/17
C815	4030017460	S.CER ECJ0EB1E102K	T	20.3/12.5
C816	4030017460	S.CER ECJ0EB1E102K	T	15.1/10.8
C817	4030017730	S.CER ECJ0EB1E471K	T	19/9
C824	4030017590	S.CER ECJ0EC1H070C	T	13/13
C825	4030017380	S.CER ECJ0EC1H050B	T	14.2/13.4
C826	4030017570	S.CER ECJ0EC1H040B	T	13/15.1
C827	4030017620	S.CER ECJ0EC1H100C	T	14.6/15.5
C828	4030017360	S.CER ECJ0EC1H030B	T	13.9/16.4
C829	4030017660	S.CER ECJ0EC1H330J	T	12.7/16.9
C830	4030017570	S.CER ECJ0EC1H040B	T	11.8/17.6
C831	4030017570	S.CER ECJ0EC1H040B	T	11.8/19.2
C832	4030017590	S.CER ECJ0EC1H070C	T	10.3/19.1
C833	4030017610	S.CER ECJ0EC1H090C	T	8.4/19.1
C834	4030017350	S.CER ECJ0EC1H020B	T	8/17.9
C835	4030017580	S.CER ECJ0EC1H060C	T	7/19.5
C838	4030017460	S.CER ECJ0EB1E102K	T	5.3/19.5
C839	4030017780	S.CER ECJ0EB1E472K	T	25.4/14.5
C840	4030017460	S.CER ECJ0EB1E102K	T	6.5/15.6
C841	4030006860	S.CER C1608 JB 1H 102K-T	B	5.1/15.3
C851	4030017780	S.CER ECJ0EB1E472K	T	4.5/14
C901	4030017780	S.CER ECJ0EB1E472K	T	2.4/68.4
C902	4030017430	S.CER ECJ0EC1H101J	T	16/53.2
C951	4030016930	S.CER ECJ0EB1A104K	T	52.3/38.2
C952	4030011600	S.CER C1608 JB 1E 104K-T	T	58.3/46.9
C953	4030016930	S.CER ECJ0EB1A104K	T	54/18.3
C954	4030017780	S.CER ECJ0EB1E472K	T	54.1/28.1
C955	4030016930	S.CER ECJ0EB1A104K	T	52.8/33.2
C956	4030016930	S.CER ECJ0EB1A104K	T	49.2/21
C957	4030016930	S.CER ECJ0EB1A104K	T	53.8/35.9
C958	4030017780	S.CER ECJ0EB1E472K	T	52.8/34.1
C959	4030017780	S.CER ECJ0EB1E472K	T	52.8/35
C960	4030016930	S.CER ECJ0EB1A104K	T	53.5/38.9
C961	4030016930	S.CER ECJ0EB1A104K	T	52.3/39.8
C962	4030016930	S.CER ECJ0EB1A104K	T	52.3/44.6
C963	4030016930	S.CER ECJ0EB1A104K	T	53.5/38
C964	4030017460	S.CER ECJ0EB1E102K	T	55/44.8
C966	4030016930	S.CER ECJ0EB1A104K	T	52.3/41.4
C967	4030016930	S.CER ECJ0EB1A104K	T	52.3/43
C968	4030018960	S.CER C3216 JB 1C 106MT-N	B	42/43.9
C969	4030006880	S.CER C1608 JB 1H 472K-T	B	48.2/23.1
C972	4030018970	S.CER C3225 JB 1C 226MT-N	B	42.2/3.5
C973	4030018970	S.CER C3225 JB 1C 226MT-N	B	29/2.7
C974	4030018970	S.CER C3225 JB 1C 226MT-N	B	32/2.7
C975	4550007140	S.TAN TEESVD 1C 107M12R	B	16.7/4.1
C976	4550007140	S.TAN TEESVD 1C 107M12R	B	23.5/10.5
C977	4550007140	S.TAN TEESVD 1C 107M12R	B	23.5/19.5
C978	4550007140	S.TAN TEESVD 1C 107M12R	B	32.3/10.5
C980	4030004720	S.CER C2012 JB 1H 102K-T	B	55.5/11
C981	4030016930	S.CER ECJ0EB1A104K	T	54.4/12.5
C982	4030006860	S.CER C1608 JB 1H 102K-T	B	14/67.1
C983	4030006860	S.CER C1608 JB 1H 102K-T	B	7.4/74
C991	4030006860	S.CER C1608 JB 1H 102K-T	B	10/68.1
C992	4030006860	S.CER C1608 JB 1H 102K-T	B	7.2/67.3
C993	4030006860	S.CER C1608 JB 1H 102K-T	B	4.2/74
C994	4030006860	S.CER C1608 JB 1H 102K-T	B	5.6/71.3
C995	4030006860	S.CER C1608 JB 1H 102K-T	B	2.2/59.2
C996	4030006860	S.CER C1608 JB 1H 102K-T	B	5/58.8
C997	4030006860	S.CER C1608 JB 1H 102K-T	B	2.9/55
C998	4030006860	S.CER C1608 JB 1H 102K-T	B	3.1/62.6
C1001	4030011600	S.CER C1608 JB 1E 104K-T	T	58.3/48.4
C1051	4030006880	S.CER C1608 JB 1H 472K-T	B	20.2/65.3
C1052	4030006880	S.CER C1608 JB 1H 472K-T	B	19.2/60.3
C1101	4030017780	S.CER ECJ0EB1E472K	T	38.9/52.1
C1102	4030017780	S.CER ECJ0EB1E472K	T	44.2/50.3
C1104	4030017780	S.CER ECJ0EB1E472K	T	42.2/62.2
C1105	4030017780	S.CER ECJ0EB1E472K	T	40.6/59.9
C1106	4030017780	S.CER ECJ0EB1E472K	T	40.4/55.9

[DDS UNIT]

REF NO.	PARTS NO.	DESCRIPTION	M.	H/V LOCATION
C1107	4030017780	S.CER ECJ0EB1E472K	T	43.3/56.9
C1108	4030017460	S.CER ECJ0EB1E102K	T	40.1/62.2
C1109	4030006880	S.CER C1608 JB 1H 472K-T	B	35.1/76.9
C1110	4030017780	S.CER ECJ0EB1E472K	T	33.5/59.6
C1111	4030017780	S.CER ECJ0EB1E472K	T	29.7/59.6
C1112	4030017780	S.CER ECJ0EB1E472K	T	38.2/63.4
C1113	4030017780	S.CER ECJ0EB1E472K	T	37.1/59.7
C1114	4030017780	S.CER ECJ0EB1E472K	T	24.4/60.6
C1115	4030017780	S.CER ECJ0EB1E472K	T	35.3/59.8
C1116	4030017460	S.CER ECJ0EB1E102K	T	23.1/63.7
C1117	4030006860	S.CER C1608 JB 1H 102K-T	B	20.9/63.9
C1151	4030017780	S.CER ECJ0EB1E472K	T	50.5/66.3
C1152	4030017780	S.CER ECJ0EB1E472K	T	46.4/66.3
C1153	4030017780	S.CER ECJ0EB1E472K	T	43.7/68.2
C1154	4030017780	S.CER ECJ0EB1E472K	T	52/66.3
C1155	4030017780	S.CER ECJ0EB1E472K	T	57.9/68.3
RL1101	6330001721	REL ATN207-K1		
J151	6510007020	CON TMP-J01X-V6		
J851	6510018450	CON TMP-S01X-B1		
J951	6510024880	S.CON 52689-3087	T	59.2/35.3
J952	6510024880	S.CON 52689-3087	T	59.2/12.4
J1001	6510003521	CON S04B-EH-S(LF)(SN)		
J1051	6450001791	CON HLJ7000-016010		
J1101	6450001641	CON TCS5044-0141177		
J1151	6450001841	CON TCS7568-4320177		
EP6	6910012350	S.BEA MMZ1608Y 102BT	B	12.9/11
EP251	6910012350	S.BEA MMZ1608Y 102BT	B	33.1/18.7
EP301	6910012350	S.BEA MMZ1608Y 102BT	B	49.7/25
EP302	6910012350	S.BEA MMZ1608Y 102BT	B	32.9/27.8
EP303	6910012350	S.BEA MMZ1608Y 102BT	B	32.9/26.1
EP305	6910012350	S.BEA MMZ1608Y 102BT	B	41/27.1
EP306	6910012350	S.BEA MMZ1608Y 102BT	B	36.6/26.3
			[EUR]	
			[FRA]	
			[ESP]	
			[USA]	
			[EXP]	
			[ITR]	
			[KOR]	
			[AUS]	
			[CHN]	
EP451	6910012350	S.BEA MMZ1608Y 102BT	B	39.9/47.8
EP809	6910012350	S.BEA MMZ1608Y 102BT	B	16.6/7.1
EP951	6910012350	S.BEA MMZ1608Y 102BT	B	53.3/24.3
EP952	6910012350	S.BEA MMZ1608Y 102BT	B	50.5/21.7
EP953	6910012350	S.BEA MMZ1608Y 102BT	T	54/43.4
EP954	6910012350	S.BEA MMZ1608Y 102BT	T	54/42.1
EP955	6910012350	S.BEA MMZ1608Y 102BT	T	54.2/40
EP956	6910012350	S.BEA MMZ1608Y 102BT	T	54.6/37
EP957	6910012350	S.BEA MMZ1608Y 102BT	B	39.5/46.1
EP958	6910012350	S.BEA MMZ1608Y 102BT	B	55.9/47.4
EP959	6910012350	S.BEA MMZ1608Y 102BT	B	56.7/32.5
EP960	6910012350	S.BEA MMZ1608Y 102BT	B	56.9/28.4
EP964	6910012350	S.BEA MMZ1608Y 102BT	B	53.3/22.2
EP981	6910012350	S.BEA MMZ1608Y 102BT	T	55.3/14.2
EP1003	6910018930	S.BEA MPZ2012S601A	T	57.2/50.3
EP1004	6910018930	S.BEA MPZ2012S601A	T	53.9/50
EP1051	6910012350	S.BEA MMZ1608Y 102BT	B	20.2/66.8
EP1052	6910012350	S.BEA MMZ1608Y 102BT	B	19.2/58.7
EP1100	6910012350	S.BEA MMZ1608Y 102BT	B	38.7/63.4
EP1101	6910012350	S.BEA MMZ1608Y 102BT	T	27.5/63.3
EP1102	6910012350	S.BEA MMZ1608Y 102BT	T	34.4/62.4
EP1103	6910012350	S.BEA MMZ1608Y 102BT	T	51.1/69.2
EP1104	6910012350	S.BEA MMZ1608Y 102BT	T	56.1/69.2
EP1105	6910014730	S.BEA MPZ2012S331A-T	B	41/67.9
EP1106	6910014730	S.BEA MPZ2012S331A-T	B	34.7/61.8
EP1107	6910014730	S.BEA MPZ2012S331A-T	B	31.4/61.8
EP1108	6910014730	S.BEA MPZ2012S331A-T	B	27/73.6
MP201	8510017200	PLA 2427 A-SHIELD PLATE Y800	B	43/14.7

M.=Mounted side (T: Mounted on the Top side, B: Mounted on the Bottom side)
S.=Surface mount

BOARD LAYOUTS

The combination of this side and the bottom side shows the board layout in the same configuration as the actual P.C.Board.

• LOGIC UNIT
(TOP VIEW)

J2101		
1	3V	EMU 2
	GND	TMS
	GND	TCK
	TDO	TRST
9	GND	TDI 10

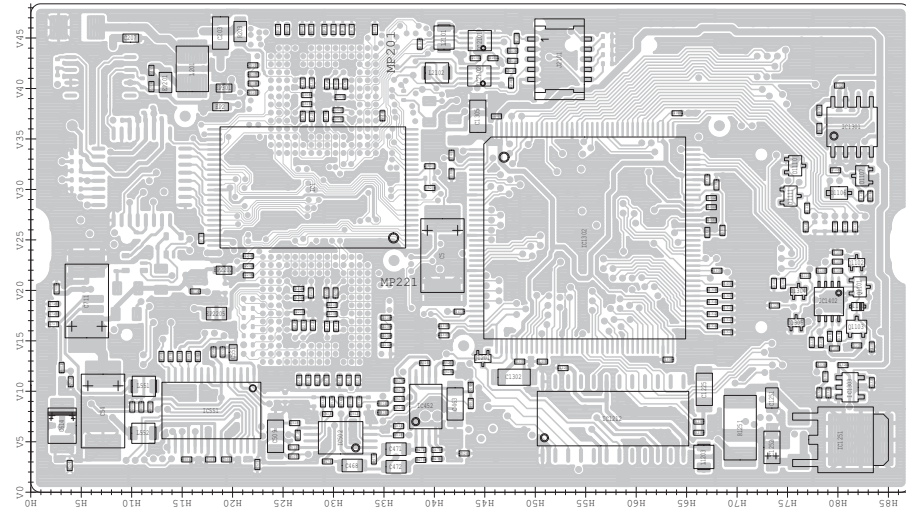

• PA UNIT
(TOP VIEW)

J980		
1	FDAT	GND
2	MCK	PRES
	MST	GND
	3R3V	HFOR
	GND	HREF
	NC	P2R8
	AT13	P4R8
	THER	PR4S
	TB1V	PR3S
	TB2V	2M8L
	PHT8	VUFOR
	PT8V	PT8V
	ID4V	P4T8
28	IDRV	P2T8

J2		
1	ID1V	HCR8
	ID2V	ICH
	POWS	ICI
	HV	GND
	GND	GND
	GND	GND
	GND	GND
	GND	8V
	8V	14V
	14V	14V
	14V	14V
	14V	14V
2		14V

to MAIN unit J2004 28

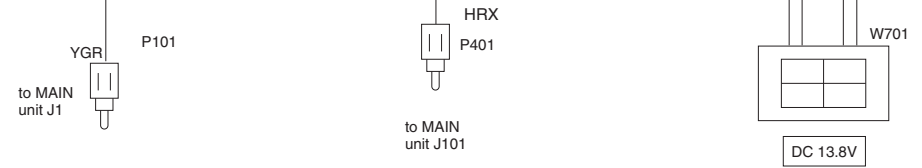
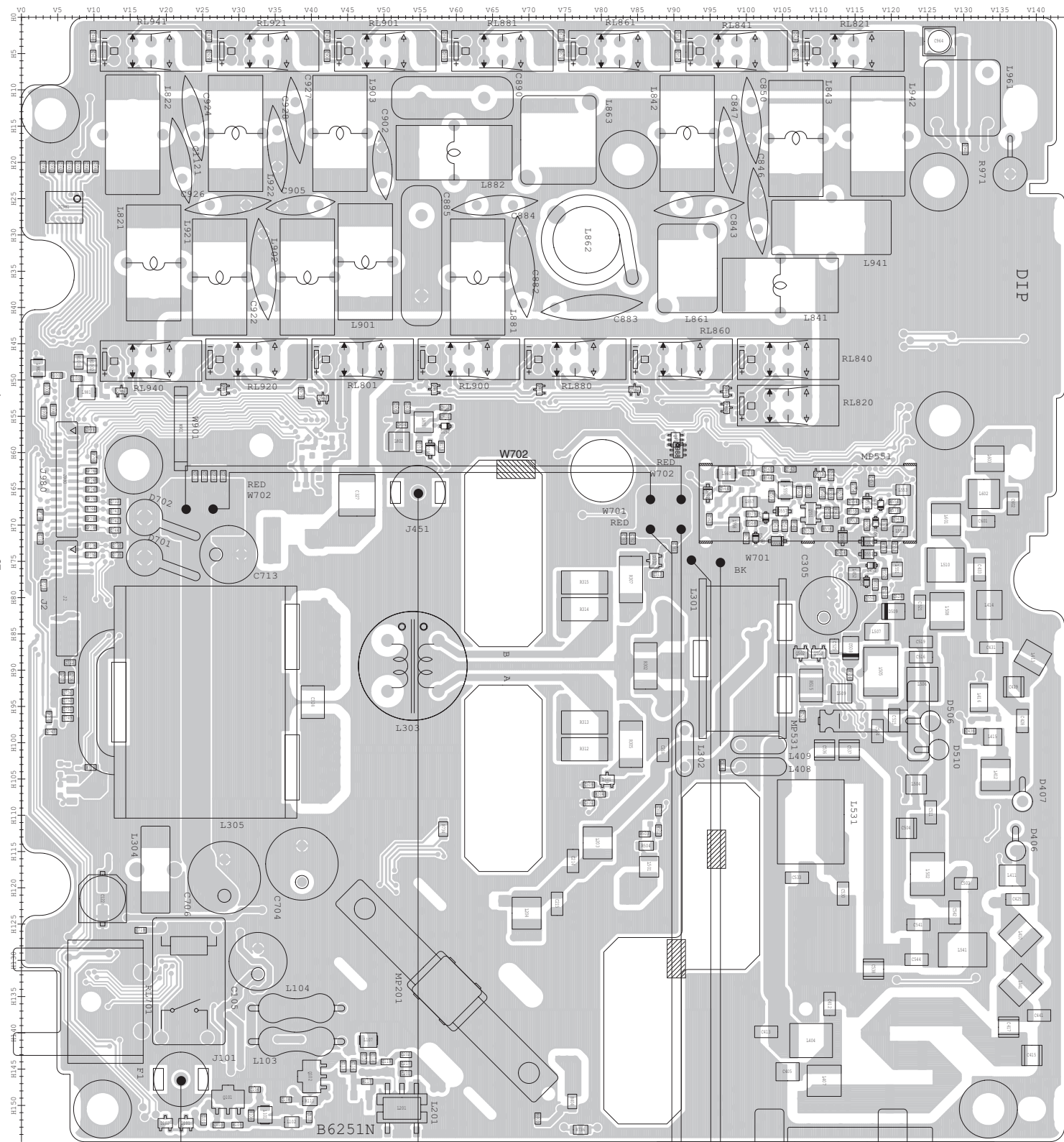

The combination of this side and the bottom side shows the board layout in the same configuration as the actual P.C.Board.

• PA UNIT
(BOTTOM VIEW)

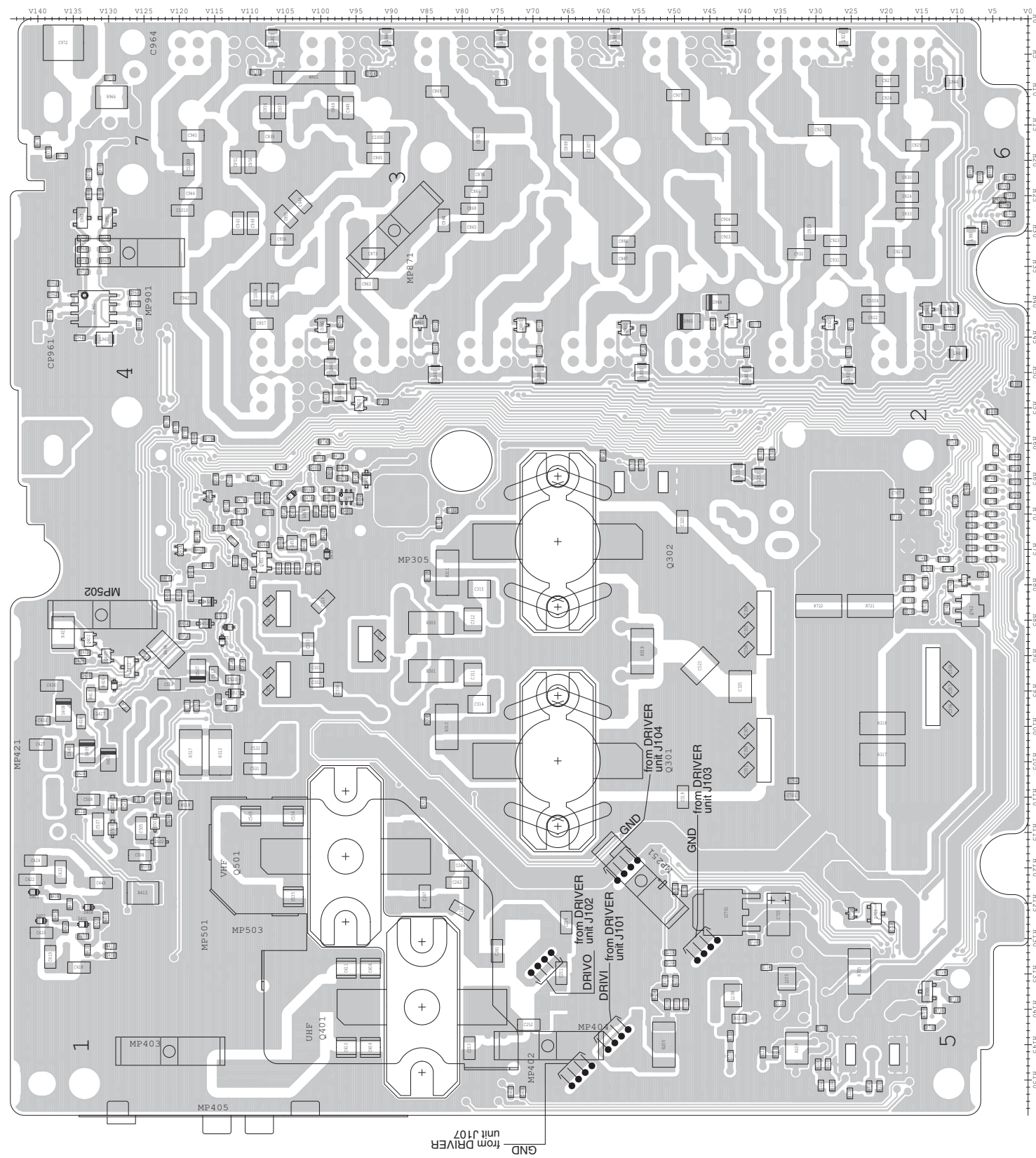

• LOGIC UNIT
(BOTTOM VIEW)

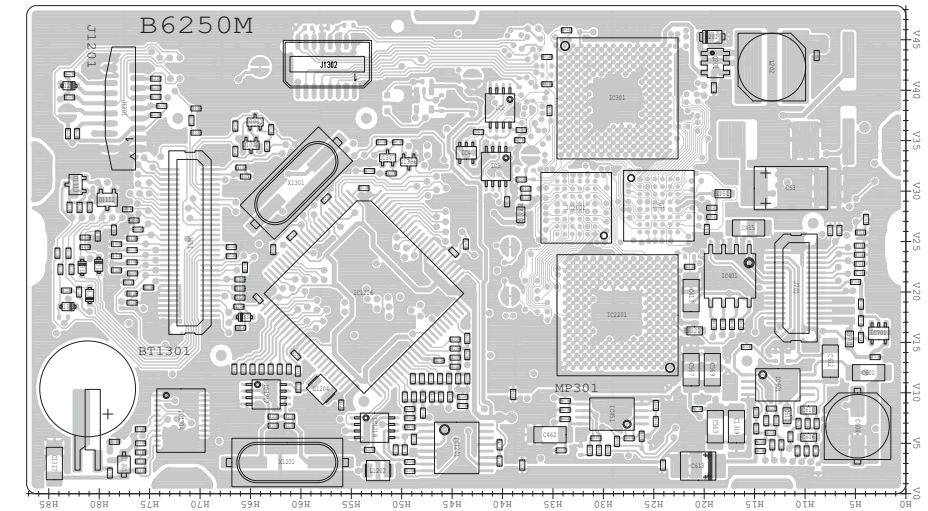

J651

60	1DST	VDL	1
	3DST	MMDK	
	PDT	SQSS	
	PCK	DOTK	
	TCNO	DASK	
	TCN1	WFML	
	PRES#	LTXD	
	LOST	LRXD	
	RS_RXD	CIV	
	RS_TXD	CIVE	
	MST	START	
	MDT	KEY	
	MCK	MUDL	
	NC	FOPL	
	SNDS	REFL	
	SDSS	ALCL	
	2T8V	SNDL	
	4T8V	DPTL	
	TXS	THML	
	RXS	CPU_P12	
	POWS	RTKI	
	VOUT	CPU_P22	
	PWRK	CPU_P94	
	GND	CPU_P95	
	GND	IMR	
	GND	CPU_PF6	
	GND	MMSL	
	GND	NC	
	GND	IMR2	
31	GND	NC	30

to MAIN unit J2252

J701

15	GND	AFMS	16
	DSP02	MOSI	
	GND	SKC	
	DSP01	VSTB	
	GND	NC	
	DOUT	NC	
	GND	NC	
	NC	24M	
	GND	HV	
	GND	8V	
	GND	8V	
	GND	5V	
	DSP1	5V	
	GND	3V	
1	DSP12	3V	30

to MAIN unit J2251

VOLTAGE DIAGRAM

• DISPLAY UNIT

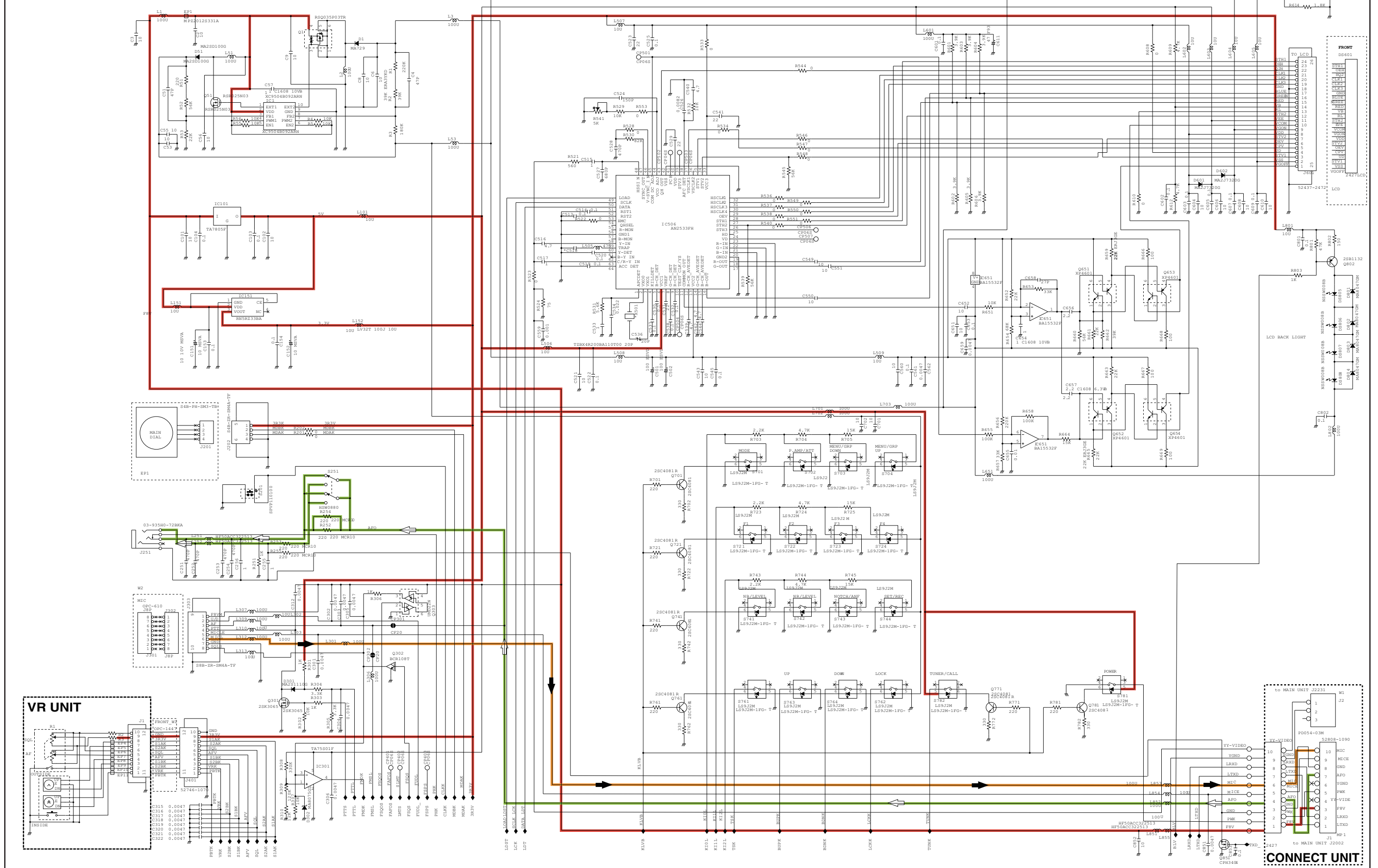

*; Refer to "PARTS LIST."

• LOGIC UNIT (1/3)

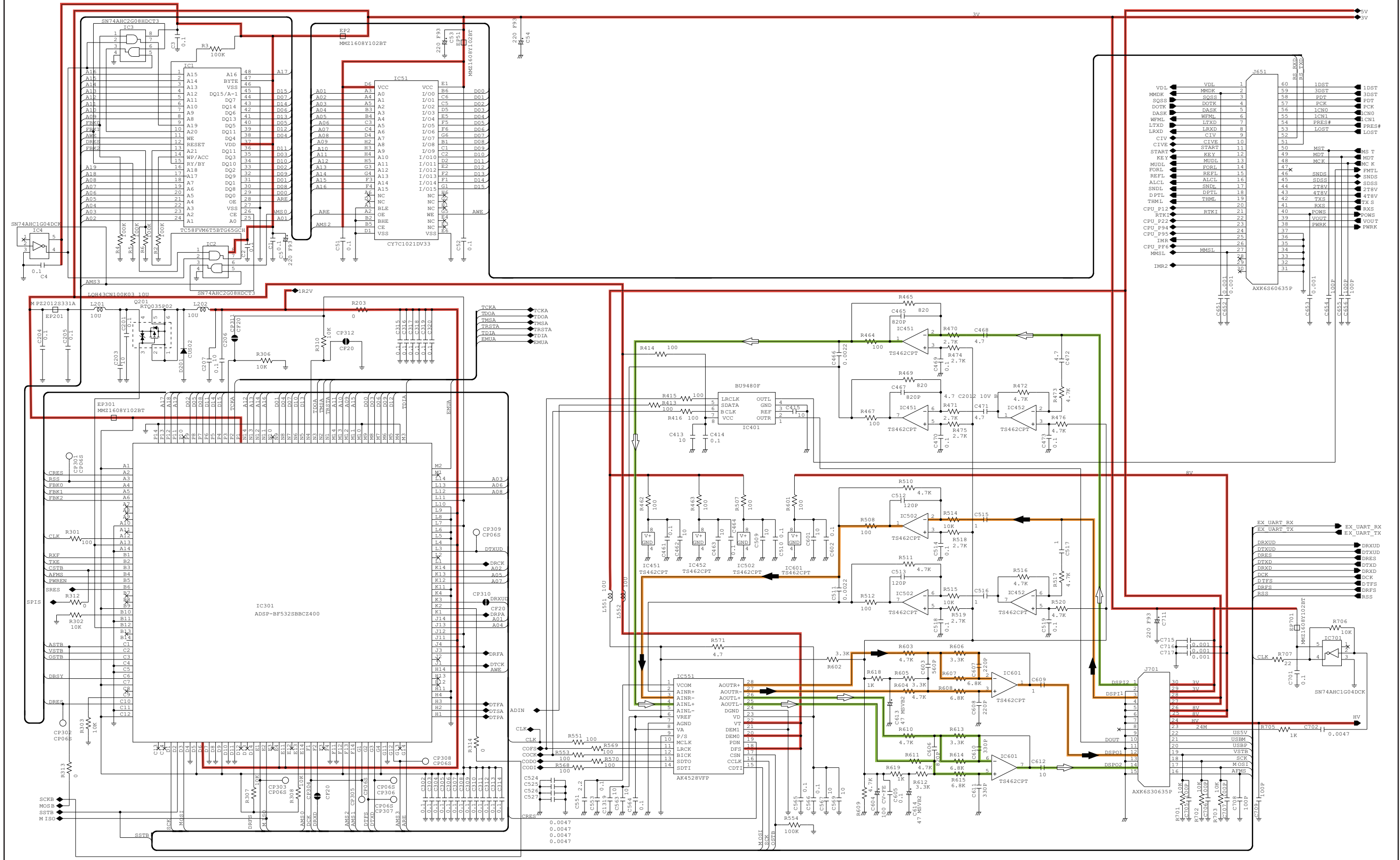

*; Refer to "PARTS LIST"

• LOGIC UNIT (2/3)

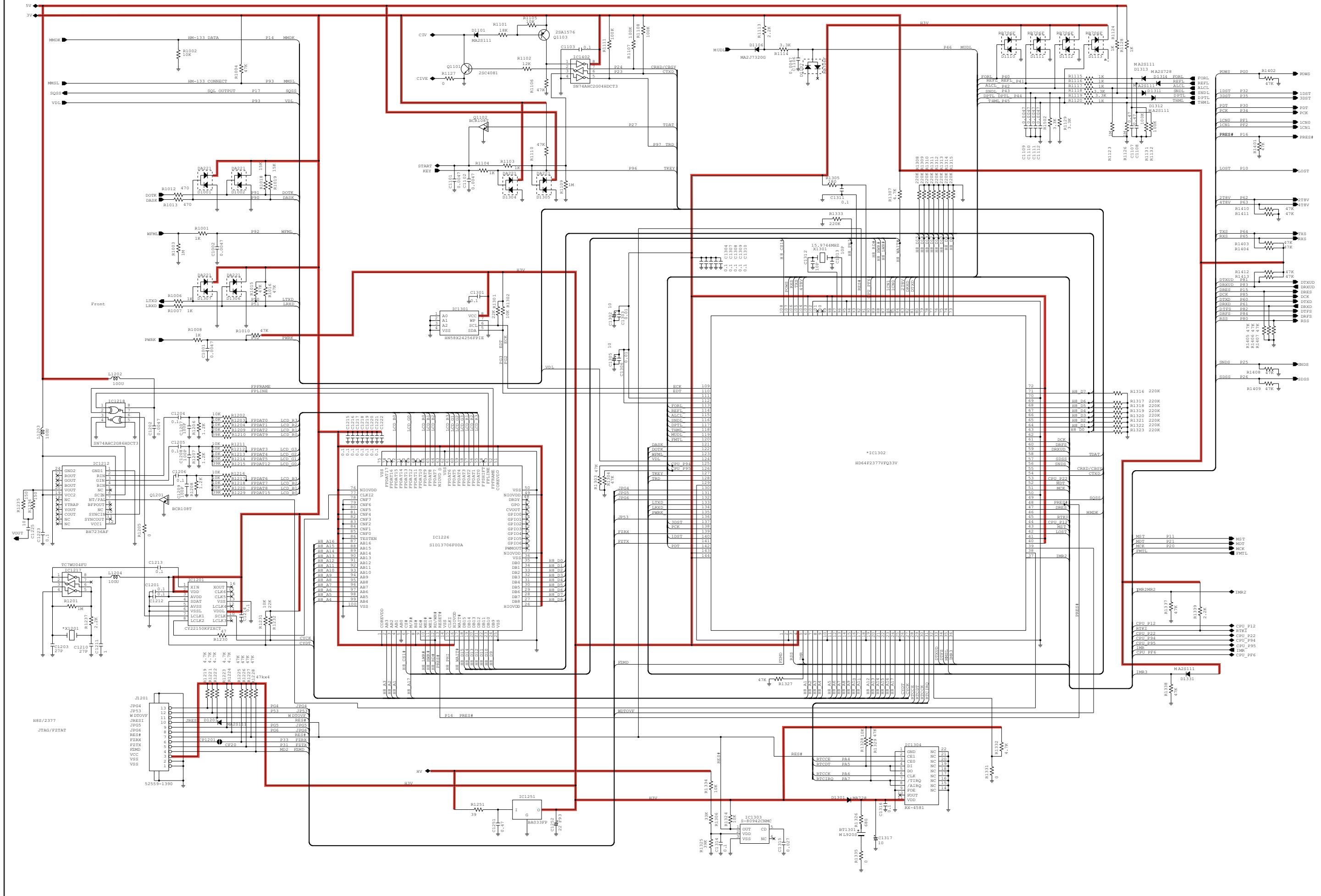

*; Refer to "PARTS LIST."

• LOGIC UNIT (3/3)

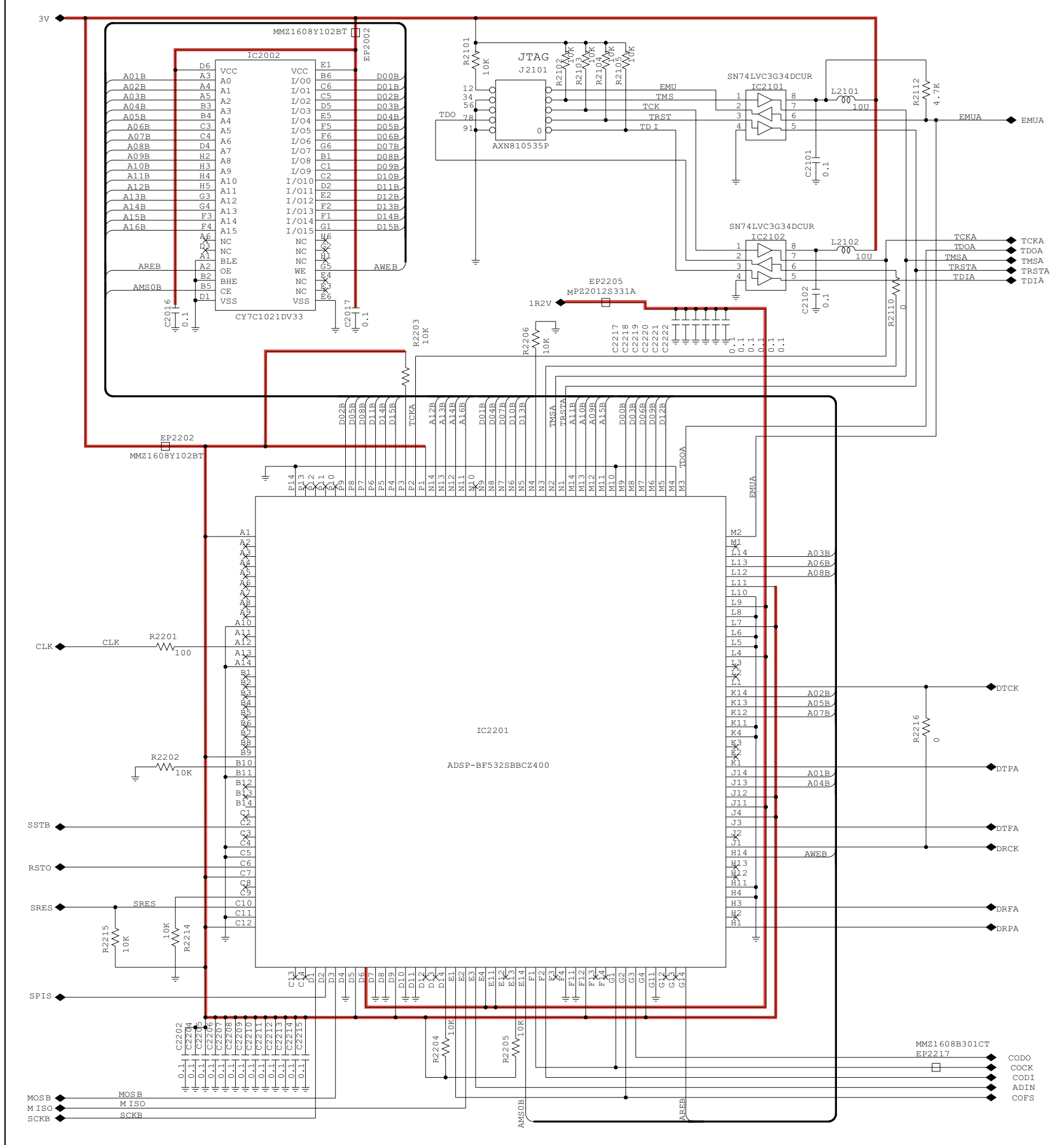

*; Refer to "PARTS LIST."

• MAIN UNIT (Left side)

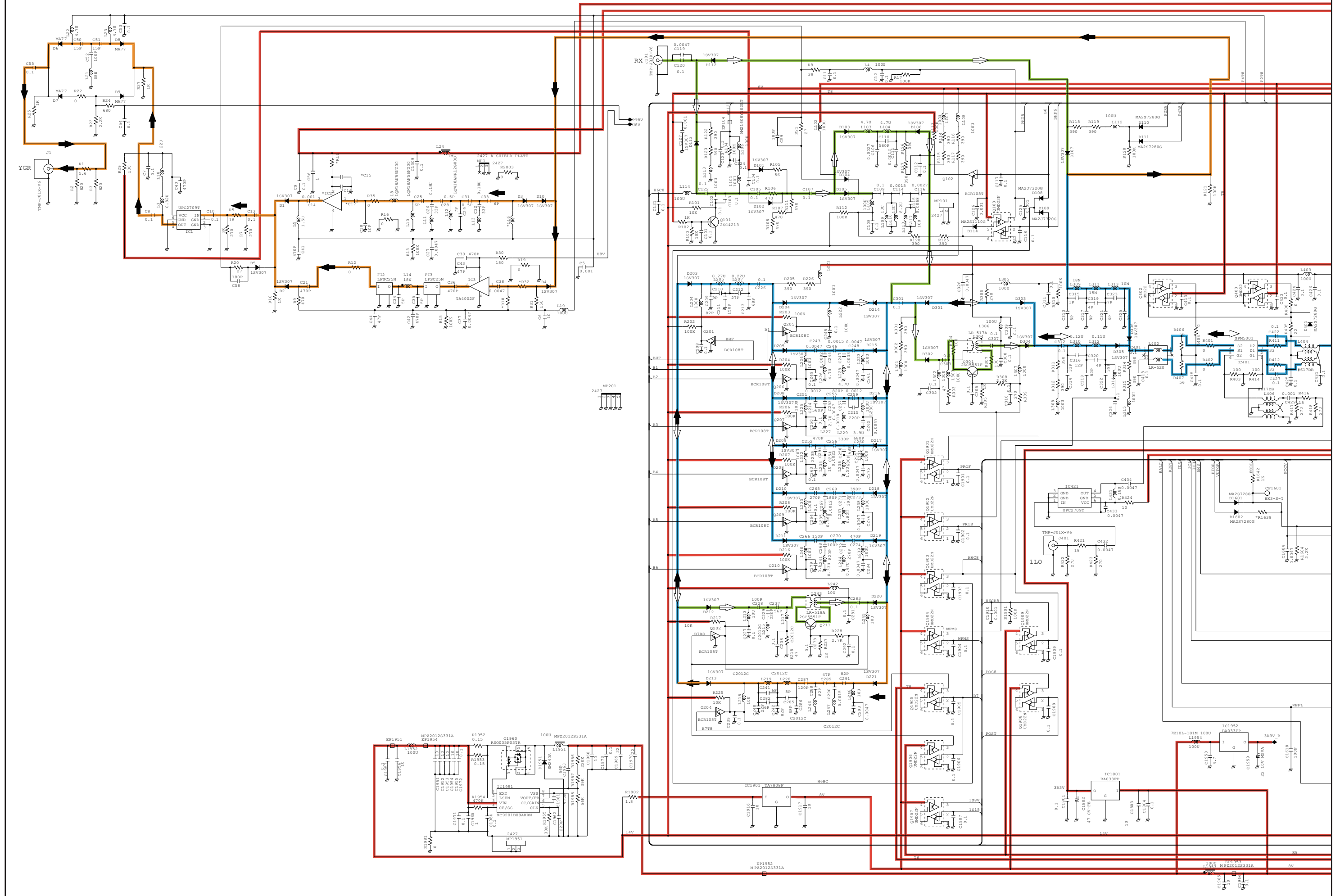

*; Refer to "PARTS LIST."

• PA UNIT (1/2)

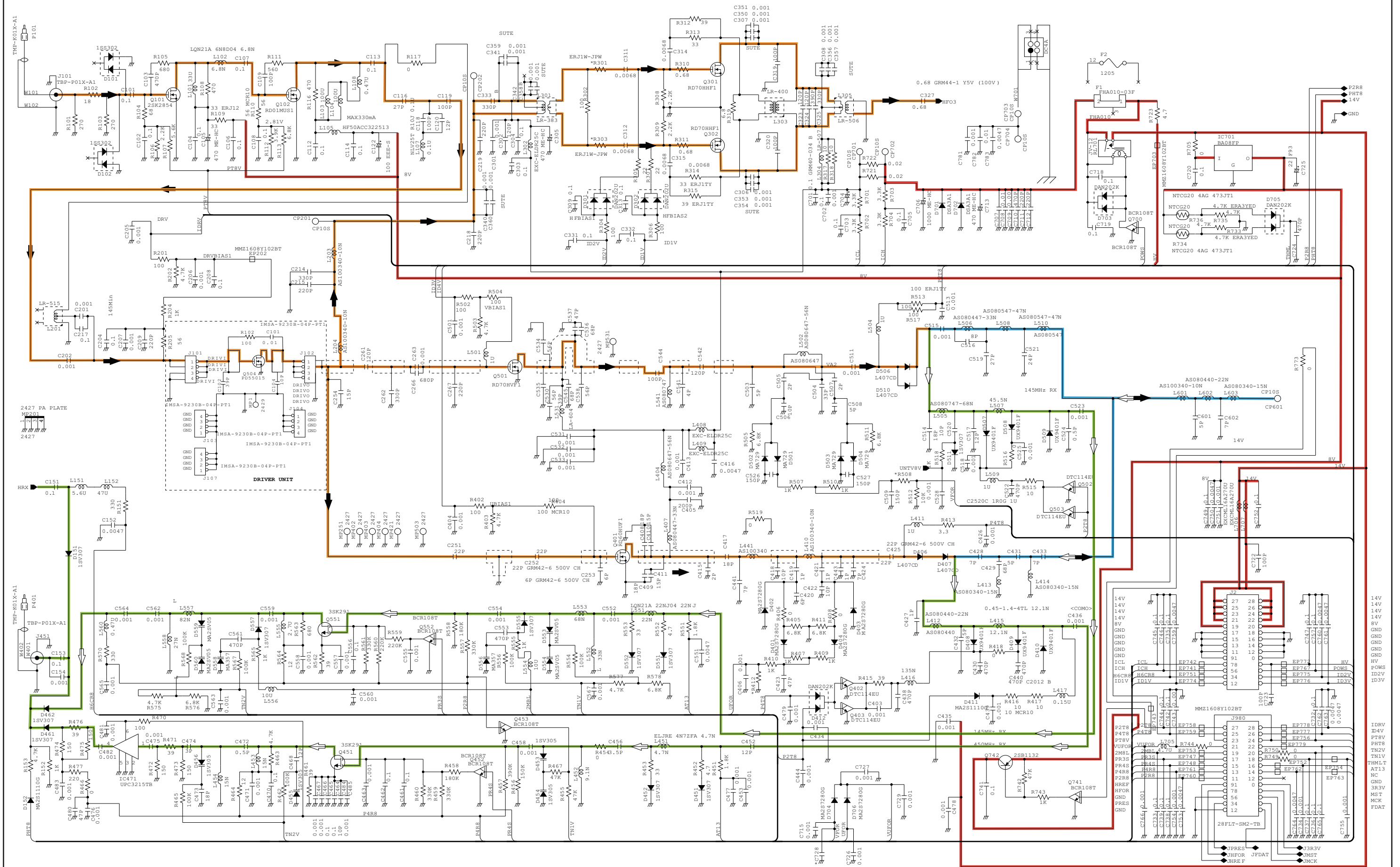

*; Refer to "PARTS LIST."

• PA UNIT (2/2)

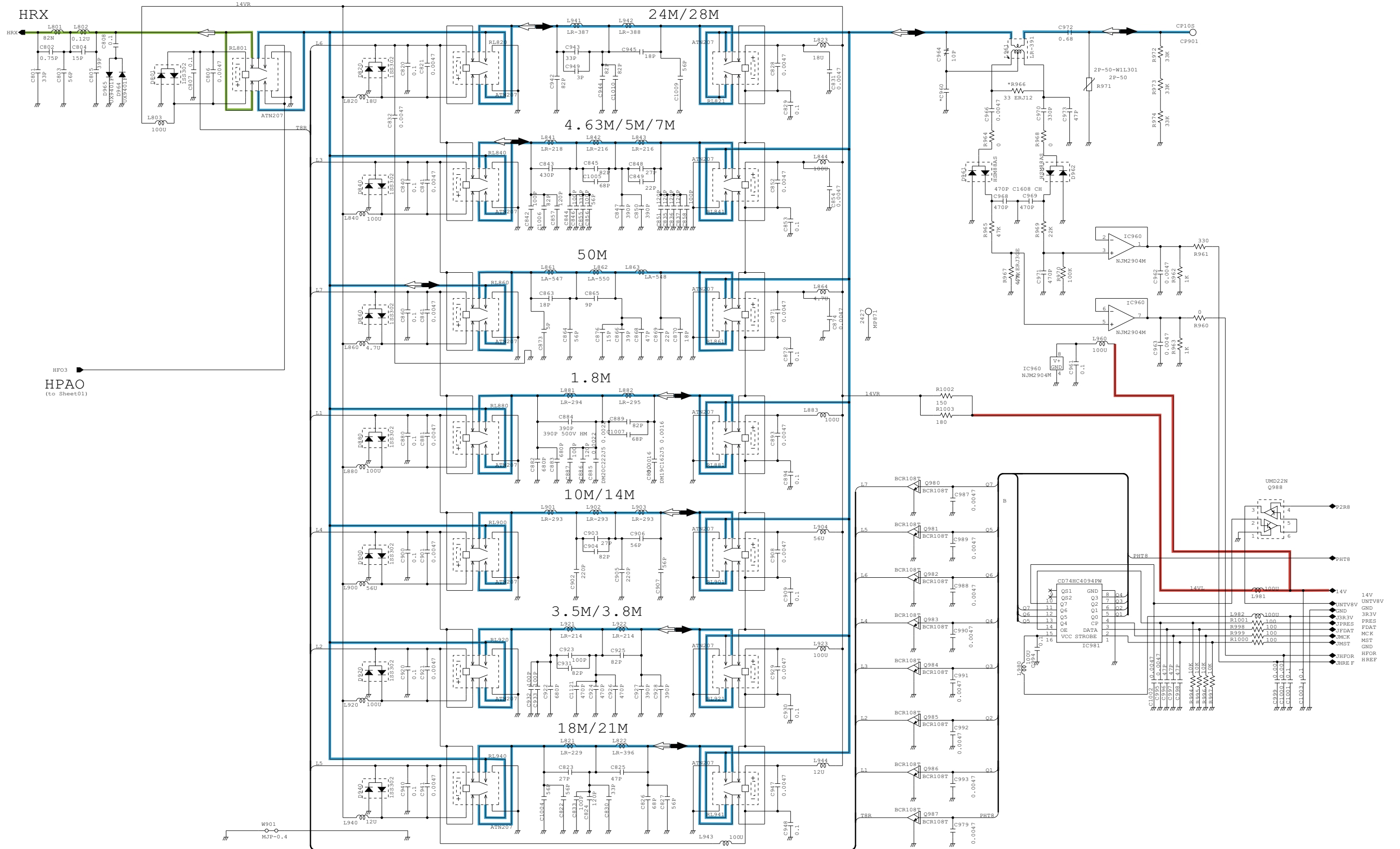

*; Refer to "PARTS LIST."

• DDS UNIT

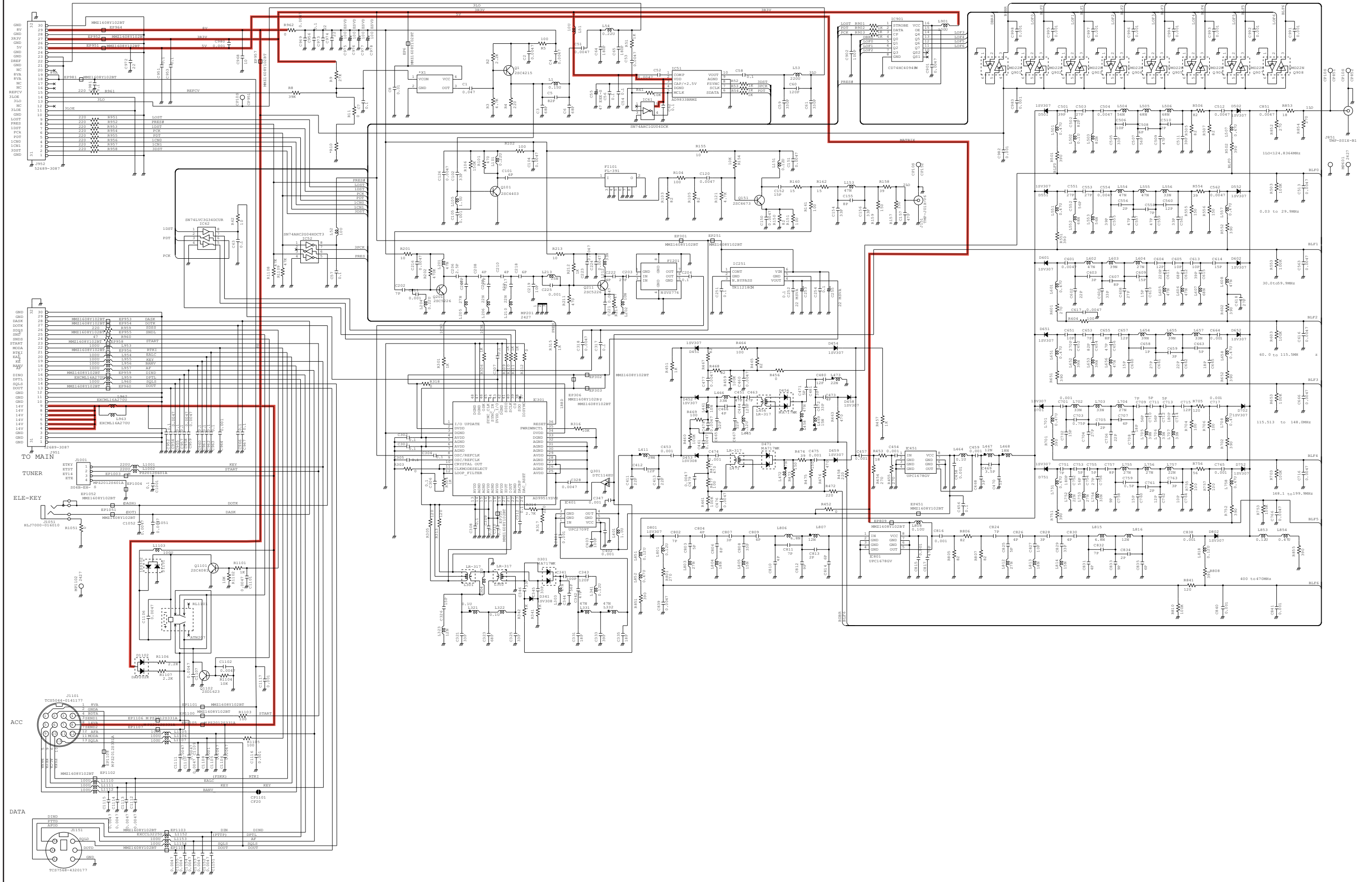

*; Refer to "PARTS LIST."

Oct. 2008



SERVICE MANUAL ADDENDUM

IC-7000

CONTENTS

PARTS LIST	1
BOARD LAYOUTS (LOGIC AND PA UNITS)	26
VOLTAGE DIAGRAM (LOGIC UNIT)	28

PARTS LIST

[MAIN UNIT]

REF NO.	PARTS NO.	DESCRIPTION	M.	H/V LOCATION	
IC401	1190002052	S.IC SPM5001-TL-E (7000)2 [EUR]	T	77.5/27.9	
	1190002052	S.IC SPM5001-TL-E (7000)2 [ESP]	T		
	1190002052	S.IC SPM5001-TL-E (7000)2 [USA]	T		
	1190002052	S.IC SPM5001-TL-E (7000)2 [EXP]	T		
	1190002052	S.IC SPM5001-TL-E (7000)2 [ITR]	T		
	1190002052	S.IC SPM5001-TL-E (7000)2 [UK]	T		
	1190002052	S.IC SPM5001-TL-E (7000)2 [CHN]	T		
	IC1	1110004080	S.IC UPC2709T-E3	T	75.6/12.7
	IC2	1110004101	S.IC TA4001F (TE85L,F)	T	64/18.8
	IC3	1110004091	S.IC TA4002F (TE85L,F)	T	48.3/17.4
IC401	1190002051	S.IC SPM5001-TL-E 1 [FRA]	T	77.5/27.9	
	1190002051	S.IC SPM5001-TL-E 1 [KOR]	T		
	1190002051	S.IC SPM5001-TL-E 1 [AUS]	T		
IC421	1110004080	S.IC UPC2709T-E3	T	86.4/19.4	
IC801	1110004080	S.IC UPC2709T-E3	T	86/57.4	
IC1101	1110006730	S.IC NJM2594V-TE1-#ZZZB	T	5/83.3	
IC1201	1130006221	S.IC TC4W53FU (TE12L,F)	T	24.2/81.6	
IC1202	1130006221	S.IC TC4W53FU (TE12L,F)	T	19.8/81.4	
IC1203	1110006570	S.IC TS462CPT	T	12.8/81.7	
IC1301	1110005461	S.IC TA4107F (TE12L,F)	T	13.7/63.4	
IC1401	1110006541	S.IC LA1225M-TLM-E	B	23.4/82.2	
IC1501	1110006530	S.IC TA4019F (TE12L,F)	B	74.8/39	
IC1502	1110005040	S.IC M52342FP 600C	B	79.7/57	
IC1601	1110005320	S.IC NJM13403V-TE1-#ZZZB	T	8.6/41.5	
IC1801	1180002020	S.REG BA033FP-E2	B	22.8/106.5	
IC1901	1180001251	S.IC TA7808F (TE16L,Q)	B	10.4/55.2	
IC1951	1190002120	S.IC XC9201D09AKR	B	41.9/107.8	
IC1952	1180002020	S.REG BA033FP-E2	B	14.7/125.8	
IC2001	1180001251	S.IC TA7808F (TE16L,Q)	B	8.5/19	
IC2007	1110006570	S.IC TS462CPT	T	15.8/121	
IC2101	1110005320	S.IC NJM13403V-TE1-#ZZZB	T	28.5/118	
IC2102	1110005320	S.IC NJM13403V-TE1-#ZZZB	T	49.5/111.9	
IC2103	1110005140	S.IC NJM3403AV-TE1-#ZZZB	T	49.5/121.2	
IC2151	1130012720	S.IC CD74HC4094PWR	T	47.1/95.9	
IC2152	1130012720	S.IC CD74HC4094PWR	T	37.9/95.9	
IC2153	1130012720	S.IC CD74HC4094PWR	T	28.1/95.8	
IC2154	1130012720	S.IC CD74HC4094PWR	T	28.2/101.5	
IC2155	1110006680	S.IC BH2221FV-E2	T	38.2/118.1	
IC2156	1130009100	S.IC BU4052BCFV-E2	T	10.1/107.6	
IC2231	1110006640	S.IC NJM2244M-TE1-#ZZZB	T	34.7/109.4	
IC2251	1130008511	S.IC TC7W53FU (TE12L,F)	T	16.7/89.5	
IC2501	1110006570	S.IC TS462CPT	B	12.7/91.7	
IC2551	1110006570	S.IC TS462CPT	B	49.2/122	
IC2601	1130006221	S.IC TC4W53FU (TE12L,F)	B	63.2/123.9	
IC2602	1110003091	IC LA4425A-E			
Q101	1530003091	S.TRA 2SC4213-B (TE85R,F)	T	11.2/17.5	
Q102	1590003940	S.TRA RN1105 (TE85L,F)	T	20.7/5.6	
Q103	1590003930	S.TRA UMD22N TR	T	38.4/20.2	
Q201	1590003940	S.TRA RN1105 (TE85L,F)	T	16.1/31.1	
Q202	1590003940	S.TRA RN1105 (TE85L,F)	T	23.5/28.5	
Q204	1590003940	S.TRA RN1105 (TE85L,F)	B	44.7/38.6	
Q205	1590003940	S.TRA RN1105 (TE85L,F)	T	42.9/61.5	
Q206	1590003940	S.TRA RN1105 (TE85L,F)	B	24.5/55	
Q207	1590003940	S.TRA RN1105 (TE85L,F)	B	24.5/51.9	
Q208	1590003940	S.TRA RN1105 (TE85L,F)	B	24.2/48.8	
Q209	1590003940	S.TRA RN1105 (TE85L,F)	B	23.5/45.7	
Q210	1590003940	S.TRA RN1105 (TE85L,F)	B	42.9/41.4	
Q211	1530003851	S.TRA 2SC5551F-TD-E 0	T	27.6/30.1	
Q301	1530003851	S.TRA 2SC5551F-TD-E 0	T	56.7/32.4	
Q402	1590003930	S.TRA UMD22N TR	T	82.8/22.8	
Q403	1590003930	S.TRA UMD22N TR	T	69.7/23.6	
Q502	1530003851	S.TRA 2SC5551F-TD-E 0	T	83/37.1	
Q701	1580000780	S.FET 3SK195 (TE85L,F)	T	62/56.5	
Q702	1580000780	S.FET 3SK195 (TE85L,F)	T	54.6/51.8	
Q901	1580000780	S.FET 3SK195 (TE85L,F)	T	36.6/65.7	
Q902	1580000780	S.FET 3SK195 (TE85L,F)	T	35.9/73.2	
Q1001	1580000780	S.FET 3SK195 (TE85L,F)	T	17.9/76	
Q1201	1590003930	S.TRA UMD22N TR	T	28/78.6	
Q1401	1530002060	S.TRA 2SC4081 T106 R	B	42.5/74.3	
Q1402	1530002060	S.TRA 2SC4081 T106 R	B	36.7/80.1	
Q1501	1590003530	S.TRA BCR08PN 0	T	30.6/78.5	
Q1521	1530002060	S.TRA 2SC4081 T106 R	B	86.6/48.6	
Q1601	1530003091	S.TRA 2SC4213-B (TE85R,F)	T	8.3/52.9	
Q1602	1590001870	S.TRA DTA114EE TL	T	4.5/53	
Q1603	1590003940	S.TRA RN1105 (TE85L,F)	T	2.8/40.7	
Q1604	1510000771	S.TRA 2SA1586-GR (TE85L,F)	T	5.1/32.7	
Q1606	1560001260	S.FET 2SK3018 T106	T	12.5/36.8	
Q1701	1540000441	S.TRA 2SD1619T-TD-E	B	52.4/48.2	
Q1702	1590003940	S.TRA RN1105 (TE85L,F)	B	54.3/52.1	
Q1703	1540000441	S.TRA 2SD1619T-TD-E	B	52.4/67.4	
Q1704	1590003940	S.TRA RN1105 (TE85L,F)	B	54.1/72.9	
Q1901	1590003930	S.TRA UMD22N TR	T	35.8/78.5	
Q1902	1590003930	S.TRA UMD22N TR	T	33.3/78.5	
Q1903	1590003930	S.TRA UMD22N TR	B	23.6/17	
Q1904	1590003930	S.TRA UMD22N TR	B	32.9/87.9	
Q1905	1590003930	S.TRA UMD22N TR	B	46/40.9	
Q1906	1590003930	S.TRA UMD22N TR	B	26.3/30.8	
Q1907	1590003930	S.TRA UMD22N TR	T	40.9/78.5	
Q1908	1590003930	S.TRA UMD22N TR	T	38.3/78.5	
Q1909	1590003930	S.TRA UMD22N TR	B	22.1/11.8	
Q1960	1550000090	S.FET RSQ035P03TR	B	37.9/103.6	

[MAIN UNIT]

REF NO.	PARTS NO.	DESCRIPTION	M.	H/V LOCATION
Q2150	1590003930	S.TRA UMD22N TR	T	48.4/100.1
Q2151	1520000460	S.TRA 2SB1132 T100 R	T	55.3/103.8
Q2152	1520000460	S.TRA 2SB1132 T100 R	T	21.3/111
Q2153	1520000460	S.TRA 2SB1132 T100 R	T	49.8/104.5
Q2154	1590003930	S.TRA UMD22N TR	T	44.7/100.1
Q2155	1590003930	S.TRA UMD22N TR	T	39.9/100.1
Q2156	1590003940	S.TRA RN1105 (TE85L,F)	T	58.9/104.5
Q2157	1590003940	S.TRA RN1105 (TE85L,F)	T	25.4/109.7
Q2158	1590003940	S.TRA RN1105 (TE85L,F)	T	45.5/107.1
Q2159	1590003930	S.TRA UMD22N TR	T	6.7/118.2
Q2160	1590003930	S.TRA UMD22N TR	T	7.7/122.2
Q2231	1590003940	S.TRA RN1105 (TE85L,F)	T	4.7/121.7
Q2232	1590003930	S.TRA UMD22N TR	T	57.3/114.8
Q2233	1590003930	S.TRA UMD22N TR	T	54.7/115.7
Q2301	1530002060	S.TRA 2SC4081 T106 R	T	30.6/109
Q2401	1540000441	S.TRA 2SD1619T-TD-E	B	80.1/26.4
Q2601	1560001260	S.FET 2SK3018 T106	B	36.2/124.6
Q2602	1560001221	S.FET ECH8301-TL-E	B	37.3/127.6
Q2603	1530002060	S.TRA 2SC4081 T106 R	T	65.3/111.3
Q2605	1590003940	S.TRA RN1105 (TE85L,F)	T	11.7/112.7
Q2606	1540000451	S.TRA 2SD1623T-TD-E	B	89.5/119.9
Q2607	1590003940	S.TRA RN1105 (TE85L,F)	B	65.4/120.5
Q2608	1590003940	S.TRA RN1105 (TE85L,F)	B	45/128.6
D1	1750000581	S.DIO 1SV307 (TPH3,F)	T	70.1/16.6
D2	1750000581	S.DIO 1SV307 (TPH3,F)	T	70.3/14.8
D3	1750000581	S.DIO 1SV307 (TPH3,F)	T	45.2/19.8
D4	1750000581	S.DIO 1SV307 (TPH3,F)	T	41.9/19
D5	1750000581	S.DIO 1SV307 (TPH3,F)	T	70.3/18.3
D6	1790000620	S.DIO MA77 (TX) 0	B	79.8/17.1
D7	1790000620	S.DIO MA77 (TX) 0	T	78/15.8
D8	1790000620	S.DIO MA77 (TX) 0	B	81.5/10.6
D9	1790000620	S.DIO MA77 (TX) 0	T	79/11.5
D10	1750000581	S.DIO 1SV307 (TPH3,F)	T	42.4/20.9
D101	1750000581	S.DIO 1SV307 (TPH3,F)	T	13.3/25.5
D102	1750000581	S.DIO 1SV307 (TPH3,F)	T	15.7/19.2
D103	1750000581	S.DIO 1SV307 (TPH3,F)	T	20.3/8.7
D104	1750000581	S.DIO 1SV307 (TPH3,F)	T	34.7/17.9
D105	1750000581	S.DIO 1SV307 (TPH3,F)	T	23.1/12.7
D106	1750000581	S.DIO 1SV307 (TPH3,F)	T	29.6/21
D107	1750000581	S.DIO 1SV307 (TPH3,F)	T	44/23.6
D108	1750000950	S.DIO MA732 (TX)	B	27.1/18.2
D109	1750000950	S.DIO MA732 (TX)	B	24.7/20.3
D110	1790001240	S.DIO MA2S728-(TX)	B	51.6/26.4
D111	1790001240	S.DIO MA2S728-(TX)	B	51.6/24.7
D112	1750000581	S.DIO 1SV307 (TPH3,F)	T	15.7/20.9
D113	1750000581	S.DIO 1SV307 (TPH3,F)	T	10.2/19.7
D114	1790001250	S.DIO MA2S111-(TX)	T	35.7/21.3
D203	1750000581	S.DIO 1SV307 (TPH3,F)	T	19.3/35.7
D204	1750000581	S.DIO 1SV307 (TPH3,F)	T	25.7/58.2
D205	1750000581	S.DIO 1SV307 (TPH3,F)	T	25.7/56.3
D208	1750000581	S.DIO 1SV307 (TPH3,F)	T	25.7/53.4
D209	1750000581	S.DIO 1SV307 (TPH3,F)	T	25.7/50.6
D210	1750000581	S.DIO 1SV307 (TPH3,F)	T	25.7/47.7
D211	1750000581	S.DIO 1SV307 (TPH3,F)	T	25.7/44.8
D212	1750000581	S.DIO 1SV307 (TPH3,F)	T	25.7/39.2
D213	1750000581	S.DIO 1SV307 (TPH3,F)	T	25.7/41.5
D214	1750000581	S.DIO 1SV307 (TPH3,F)	T	47.7/59.3
D215	1750000581	S.DIO 1SV307 (TPH3,F)	T	47.7/56.3
D216	1750000581	S.DIO 1SV307 (TPH3,F)	T	47.9/53.6
D217	1750000581	S.DIO 1SV307 (TPH3,F)	T	47.8/49.7
D218	1750000581	S.DIO 1SV307 (TPH3,F)	B	41.7/47.2
D219	1750000581	S.DIO 1SV307 (TPH3,F)	B	38.9/41.6
D220	1750000581	S.DIO 1SV307 (TPH3,F)	B	44.6/28.5
D221	1750000581	S.DIO 1SV307 (TPH3,F)	B	40.4/36
D301	1750000581	S.DIO 1SV307 (TPH3,F)	T	47.3/28.5
D302	1750000581	S.DIO 1SV307 (TPH3,F)	T	49.5/30.3
D303	1750000581	S.DIO 1SV307 (TPH3,F)	T	64.1/29.9
D304	1750000581	S.DIO 1SV307 (TPH3,F)	T	62.4/35.2
D305	1750000581	S.DIO 1SV307 (TPH3,F)	T	73.3/35.2
D306	1750000581	S.DIO 1SV307 (TPH3,F)	T	64.5/25.7
D401	1790001240	S.DIO MA2S728-(TX)	T	86.6/24.9
D501	1750000531	S.DIO 1SV271 (TPH3,F)	T	90.6/32.2
D502	1750000581	S.DIO 1SV307 (TPH3,F)	T	86.2/31.4
D503	1750000581	S.DIO 1SV307 (TPH3,F)	T	89.4/29.7
D504	1750000531	S.DIO 1SV271 (TPH3,F)	T	89.7/37.7
D505	1750000581	S.DIO 1SV307 (TPH3,F)	T	86.7/40.1
D506	1750000581	S.DIO 1SV307 (TPH3,F)	B	87.2/35.5
D601	1750000581	S.DIO 1SV307 (TPH3,F)	B	90/38.5
D602	1750000581	S.DIO 1SV307 (TPH3,F)	T	92.4

[MAIN UNIT]

REF NO.	PARTS NO.	DESCRIPTION	M.	H/V LOCATION
D1302	1750000581	S.DIO 1SV307(TPH3,F)	T	13.9/70.8
D1521	1750000531	S.DIO 1SV271(TPH3,F)	B	79.4/40.7
D1522	1750000531	S.DIO 1SV271(TPH3,F)	B	79.4/42.4
D1601	1790001240	S.DIO MA2S728-(TX)	T	15.1/48.7
D1602	1790001240	S.DIO MA2S728-(TX)	T	18.3/53.1
D1604	1790001250	S.DIO MA2S111-(TX)	T	7.7/31.5
D1605	1790001250	S.DIO MA2S111-(TX)	T	7.7/32.8
D1606	1790001250	S.DIO MA2S111-(TX)	T	14.1/44.8
D1607	1790001250	S.DIO MA2S111-(TX)	T	14.1/43.5
D1608	1790001250	S.DIO MA2S111-(TX)	T	14.1/42.2
D1609	1790001330	S.ZEN MA8036-L(TX)	T	7.5/29.9
D1610	1790001250	S.DIO MA2S111-(TX)	T	12.3/34.9
D1701	1790001670	S.DIO RB706F-40T106	B	50.2/52.2
D1702	1790001670	S.DIO RB706F-40T106	B	51.8/71.8
D1951	1750001110	S.DIO SM240A-T	B	36.2/99.9
D2151	1790001250	S.DIO MA2S111-(TX) [USA]	T	39/87.1
	1790001250	S.DIO MA2S111-(TX) [KOR]		
	1790001250	S.DIO MA2S111-(TX) [AUS]		
D2153	1790001250	S.DIO MA2S111-(TX) [USA]	T	36.5/87.1
	1790001250	S.DIO MA2S111-(TX) [KOR]		
D2154	1790001250	S.DIO MA2S111-(TX)	T	36.5/88.4
D2155	1790001250	S.DIO MA2S111-(TX)	T	36.6/89.7
D2156	1790001250	S.DIO MA2S111-(TX)	T	39/90.5
D2157	1790001250	S.DIO MA2S111-(TX) [EUR]	T	48.5/87.1
	1790001250	S.DIO MA2S111-(TX) [ESP]		
	1790001250	S.DIO MA2S111-(TX) [USA]		
	1790001250	S.DIO MA2S111-(TX) [EXP]		
	1790001250	S.DIO MA2S111-(TX) [ITR]		
	1790001250	S.DIO MA2S111-(TX) [UK]		
	1790001250	S.DIO MA2S111-(TX) [KOR]		
	1790001250	S.DIO MA2S111-(TX) [AUS]		
	1790001250	S.DIO MA2S111-(TX) [CHN]		
D2158	1790001250	S.DIO MA2S111-(TX)	T	48.5/88.4
D2159	1790001250	S.DIO MA2S111-(TX)	T	48.5/89.7
D2160	1790001250	S.DIO MA2S111-(TX)	T	48.5/91
D2162	1790001250	S.DIO MA2S111-(TX) [USA] only	T	46/88.4
D2163	1790001250	S.DIO MA2S111-(TX) [EUR]	T	46/89.7
	1790001250	S.DIO MA2S111-(TX) [FRA]		
	1790001250	S.DIO MA2S111-(TX) [ESP]		
	1790001250	S.DIO MA2S111-(TX) [ITR]		
	1790001250	S.DIO MA2S111-(TX) [UK]		
D2166	1790001250	S.DIO MA2S111-(TX) [ESP]	T	29.4/88.2
	1790001250	S.DIO MA2S111-(TX) [ITR]		
	1790001250	S.DIO MA2S111-(TX) [KOR]		
D2168	1790001250	S.DIO MA2S111-(TX) [EUR]	T	29.4/90.6
	1790001250	S.DIO MA2S111-(TX) [ESP]		
	1790001250	S.DIO MA2S111-(TX) [ITR]		
	1790001250	S.DIO MA2S111-(TX) [UK]		
D2169	1790001250	S.DIO MA2S111-(TX) [AUS]	T	26.9/87.1
	1790001250	S.DIO MA2S111-(TX) [EUR]		
	1790001250	S.DIO MA2S111-(TX) [ESP]		
	1790001250	S.DIO MA2S111-(TX) [USA]		
	1790001250	S.DIO MA2S111-(TX) [EXP]		
	1790001250	S.DIO MA2S111-(TX) [ITR]		
	1790001250	S.DIO MA2S111-(TX) [UK]		
	1790001250	S.DIO MA2S111-(TX) [KOR]		
	1790001250	S.DIO MA2S111-(TX) [CHN]		
D2170	1790001250	S.DIO MA2S111-(TX) [AUS]	T	26.9/88.4
	1790001250	S.DIO MA2S111-(TX) [USA]		
	1790001250	S.DIO MA2S111-(TX) [EXP]		
	1790001250	S.DIO MA2S111-(TX) [UK]		
	1790001250	S.DIO MA2S111-(TX) [KOR]		
	1790001250	S.DIO MA2S111-(TX) [CHN]		
D2171	1790001250	S.DIO MA2S111-(TX) [FRA]	T	26.9/89.7
	1790001250	S.DIO MA2S111-(TX) [ESP]		
	1790001250	S.DIO MA2S111-(TX) [EXP]		
	1790001250	S.DIO MA2S111-(TX) [UK]		
	1790001250	S.DIO MA2S111-(TX) [KOR]		
	1790001250	S.DIO MA2S111-(TX) [CHN]		
D2172	1790001250	S.DIO MA2S111-(TX)	T	26.9/91
D2173	1790001250	S.DIO MA2S111-(TX)	T	6.4/120.2
D2174	1790001250	S.DIO MA2S111-(TX)	T	52/88.2
D2175	1790001250	S.DIO MA2S111-(TX)	T	52/87
D2201	1730002340	S.ZEN MA8047-M(TX)	T	10.5/122.8
D2205	1790001010	S.ZEN MA8043-L(TX)	T	13.5/115.2
D2211	1790001010	S.ZEN MA8043-L(TX)	T	21.5/118
D2231	1160000070	S.DIO DAN202K T146	T	57.6/117.8
D2232	1790001670	S.DIO RB706F-40T106	T	56.8/112.2
D2401	1160000070	S.DIO DAN202K T146	B	85.7/27.2
D2402	1790001250	S.DIO MA2S111-(TX)	T	63.5/113.2
D2551	1790001140	S.ZEN MA8039-L(TX)	B	45.3/116.5
D2601	1160000070	S.DIO DAN202K T146	B	42/126.3
D2602	1790001250	S.DIO MA2S111-(TX)	B	41.2/128.5
FI2	2040001420	S.LC LFB32440MSC1-955 (LFSC25N12B0)	T	59.3/13.9
FI3	2040001420	S.LC LFB32440MSC1-955 (LFSC25N12B0)	T	53.3/13.4
FI601	2010002640	S.XTA DSF753SDF 124.487 MHz (FL-374)	T	81/43.7
FI901	2020002011	S.CER CFUKG455KF4A-R0	T	44.7/69.7
FI1001	2020002011	S.CER CFUKG455KF4A-R0	T	27.8/66.9
FI1401	2020001810	S.CER SFECV10M7FA00-R0 (SFECV10.7MA5S)	B	37.5/76.4
FI1402	2020001810	S.CER SFECV10M7FA00-R0 (SFECV10.7MA5S)	B	29.5/77.5
FI1501	2040001561	SAW TSB6321DL [EUR]		
	2040001561	SAW TSB6321DL [FRA]		
	2040001561	SAW TSB6321DL [ESP]		

[MAIN UNIT]

REF NO.	PARTS NO.	DESCRIPTION	M.	H/V LOCATION
FI1501	2040001571	SAW TSB6221DL [USA]		
	2040001561	SAW TSB6321DL [EXP]		
	2040001561	SAW TSB6321DL [ITR]		
	2040001561	SAW TSB6321DL [UK]		
	2040001571	SAW TSB6221DL [KOR]		
	2040001561	SAW TSB6321DL [AUS]		
	2040001561	SAW TSB6321DL [CHN]		
FI1502	2020001720	S.CER SFSKA5M50CF00-R1 (SFSCC5.5MC2-T) [EUR]	B	69.3/57.8
	2020001720	S.CER SFSKA5M50CF00-R1 (SFSCC5.5MC2-T) [FRA]		
	2020001720	S.CER SFSKA5M50CF00-R1 (SFSCC5.5MC2-T) [ESP]		
	2020001700	S.CER SFSKA4M50CF00-R1 (SFSCC4.5MC2-T) [USA]		
	2020001720	S.CER SFSKA5M50CF00-R1 (SFSCC5.5MC2-T) [EXP]		
	2020001720	S.CER SFSKA5M50CF00-R1 (SFSCC5.5MC2-T) [ITR]		
	2020001720	S.CER SFSKA5M50CF00-R1 (SFSCC5.5MC2-T) [UK]		
	2020001700	S.CER SFSKA4M50CF00-R1 (SFSCC4.5MC2-T) [KOR]		
	2020001720	S.CER SFSKA5M50CF00-R1 (SFSCC5.5MC2-T) [AUS]		
	2020001720	S.CER SFSKA5M50CF00-R1 (SFSCC5.5MC2-T) [CHN]		
FI1503	2020001730	S.CER TPSKA5M50B00-R1 (TPSCC5.5MB-TC1) [EUR]	B	73.5/78.7
	2020001730	S.CER TPSKA5M50B00-R1 (TPSCC5.5MB-TC1) [FRA]		
	2020001730	S.CER TPSKA5M50B00-R1 (TPSCC5.5MB-TC1) [ESP]		
	2020001710	S.CER TPSKA4M50B00-R1 (TPSCC4.5MO-TC1) [USA]		
	2020001730	S.CER TPSKA5M50B00-R1 (TPSCC5.5MB-TC1) [EXP]		
	2020001730	S.CER TPSKA5M50B00-R1 (TPSCC5.5MB-TC1) [ITR]		
	2020001730	S.CER TPSKA5M50B00-R1 (TPSCC5.5MB-TC1) [UK]		
	2020001710	S.CER TPSKA4M50B00-R1 (TPSCC4.5MO-TC1) [KOR]		
	2020001730	S.CER TPSKA5M50B00-R1 (TPSCC5.5MB-TC1) [AUS]		
	2020001730	S.CER TPSKA5M50B00-R1 (TPSCC5.5MB-TC1) [CHN]		
L3	6200004480	S.COI MLF1608D R82K-T	T	76.4/10.1
L4	6200002041	S.COI NLV25T-101J	T	75.6/18.9
L5	6200004780	S.COI MLF1608A 1R5K-T	T	67.4/18.6
L7	6200011320	COI ELJQE 56NJ 2 [AUS] only		
L8	6200010910	S.COI LQW18AN56NG00D	T	57/16.6
L10	6200010910	S.COI LQW18AN56NG00D	T	57.3/17.9
L11	6200011780	S.COI LQW18ANR18G00D	T	56.5/20
L12	6200011680	S.COI LQW18ANR12G00D	T	53.8/19.8
L13	6200011780	S.COI LQW18ANR18G00D	T	52.8/18.5
L14	6200009590	S.COI MLG1608B 18NJ-T	T	57.3/11.4
L16	6200005721	S.COI ELJRE 33NGFA [EUR]	T	49.6/19.8
	6200005721	S.COI ELJRE 33NGFA [FRA]		
	6200005721	S.COI ELJRE 33NGFA [ESP]		
	6200005721	S.COI ELJRE 33NGFA [USA]		
	6200005721	S.COI ELJRE 33NGFA [EXP]		
	6200005721	S.COI ELJRE 33NGFA [ITR]		
	6200006991	S.COI ELJRE 56NGFA [UK]		
	6200005721	S.COI ELJRE 33NGFA [KOR]		
	6200005721	S.COI ELJRE 33NGFA [AUS]		
	6200005721	S.COI ELJRE 33NGFA [CHN]		
L18	6200005041	S.COI NLV25T-220J	T	73.4/9.5
L19	6200002041	S.COI NLV25T-101J	T	66.9/14.8
L21	6200006671	S.COI ELJRE 68NGFA	B	80.4/14.6
L22	6200002861	S.COI NLV25T-4R7J	B	79.7/20.2
L23	6200002861	S.COI NLV25T-4R7J	B	84/9.2
L24	6200011520	S.COI SLF7045T-102MR14-PF	B	8.8/69
L101	6200002041	S.COI NLV25T-101J	T	15.7/17
L102	6200002041	S.COI NLV25T-101J	T	20.4/10.9
L103	6200010800	S.COI C2520C-4R7G-A	T	24.4/7.4
L104	6200010800	S.COI C2520C-4R7G-A	T	27.9/10
L105	6200002041	S.COI NLV25T-101J	T	28.1/12.8
L106	6200002041	S.COI NLV25T-101J	B	17.5/16.3
L107	6200002041	S.COI NLV25T-101J	B	31.6/21.6
L108	6200002041	S.COI NLV25T-101J	T	25.2/20.8
L109	6200001831	S.COI NLV32T-100J	T	28.5/15.6
L110	6200003121	S.COI NLV32T-8R2J	T	21.1/15.1
L112	6200002041	S.COI NLV25T-101J	B	43.5/23
L113	6200002041	S.COI NLV25T-101J	T	7.2/17.6
L114	6200002041	S.COI NLV25T-101J	T	7.2/15
L116	6200003131	S.COI NLV32T-120J	T	28.5/18.6
L117	6200001831	S.COI NLV32T-100J	T	21.1/18.1
L204	6200002041	S.COI NLV25T-101J	T	18.7/32.9
L205	6200010740	S.COI C2520C-R27G-A	T	20.2/38.1
L207	6200010680	S.COI C2520C-R22G-A (0.22U)	T	21.8/41.3
L213	6200005011	S.COI NLV25T-100J	T	22.7/34.9
L215	6200010330	S.COI C2012C-R18G-A	B	27.7/38.6
L217	6200009990	S.COI C2012C-R22G-A	T	22.7/32.5
L218	6200005011	S.COI NLV25T-100J	B	25.6/43.3
L219	6200011050	S.COI C2012C-R12G-A	B	29/41.4
L220	6200010320	S.COI C2012C-R15G-A	B	34.1/37.9

M.=Mounted side (T: Mounted on the Top side, B: Mounted on the Bottom side) S.=Surface mount

[MAIN UNIT]

REF NO.	PARTS NO.	DESCRIPTION	M.	H/V LOCATION
L221	6200002041	S.COI NLV25T-101J	T	15.1/52.6
L222	6200002041	S.COI NLV25T-101J	T	45.6/61.4
L223	6200002041	S.COI NLV25T-101J	B	40.4/55.3
L224	6200002041	S.COI NLV25T-101J	B	27.5/55.7
L225	6200002041	S.COI NLV25T-101J	B	27.4/52
L226	6200002861	S.COI NLV25T-4R7J	T	40.3/57.6
L227	6200003711	S.COI NLV25T-2R7J	T	29.1/55.5
L228	6200002861	S.COI NLV25T-4R7J	T	44.6/54.7
L229	6200004671	S.COI NLV25T-3R9J	T	35.1/51.5
L230	6200002041	S.COI NLV25T-101J	B	40.4/52.2
L231	6200002041	S.COI NLV25T-101J	B	40.4/49.4
L232	6200002041	S.COI NLV25T-101J	B	27.1/49.1
L233	6200002041	S.COI NLV25T-101J	B	26.4/46.2
L234	6200010780	S.COI C2520C-1R0G-A	T	35.5/48.5
L235	6200010530	S.COI C2520C-R56G-A (0.56U)	B	32.9/49.5
L236	6200010950	S.COI C2520C-1R5G-A (1.5U)	T	43.4/50.4
L237	6200010450	S.COI C2520C-R82G-A (0.82U)	B	32.9/46.3
L238	6200002041	S.COI NLV25T-101J	B	43.9/45
L239	6200002041	S.COI NLV25T-101J	B	38.8/39.5
L240	6200002041	S.COI NLV25T-101J	T	29.5/42.1
L241	6200010870	S.COI C2520C-R33G-A (0.33U)	B	35.1/41.6
L242	6200005011	S.COI NLV25T-100J	T	33.5/29.9
L243	6140004601	S.COI LR-518A	T	28.4/35.2
L244	6200010960	S.COI C2520C-R47G-A (0.47U)	B	39.7/44.1
L245	6200005011	S.COI NLV25T-100J	B	41.2/28.3
L246	6200009990	S.COI C2012C-R22G-A	B	30.7/36.4
L247	6200010320	S.COI C2012C-R15G-A	B	42.1/38.7
L248	6200005011	S.COI NLV25T-100J	B	43.8/36.3
L301	6200002041	S.COI NLV25T-101J	T	36.1/27.4
L302	6200002041	S.COI NLV25T-101J	T	52.6/31.8
L303	6200002041	S.COI NLV25T-101J	T	52.3/35.4
L304	6140004591	S.COI LR-517A	T	56.4/39
L305	6200002041	S.COI NLV25T-101J	T	52.8/29.3
L306	6200002041	S.COI NLV25T-101J	T	61.7/39.3
L307	6200002041	S.COI NLV25T-101J	T	60.9/32
L308	6200002041	S.COI NLV25T-101J	T	64.9/33.1
L309	6200009070	S.COI LQW18AN18NG00D (LQW1608A18NG00)	T	49.3/24
L310	6200010650	S.COI C2520C-R12G-A (0.12U)	T	65.7/38.2
L311	6200009220	S.COI LQW18AN15NG00D (LQW1608A15NG00)	T	53.5/23.2
L312	6200010660	S.COI C2520C-R15G-A (0.15U)	T	69.6/34.3
L313	6200011730	S.COI LQW18AN10NG00D	T	61.5/25.7
L314	6200002041	S.COI NLV25T-101J	T	72.5/37.3
L315	6200002041	S.COI NLV25T-101J	T	75.8/31.9
L402	6140004610	S.COI LR-520	T	70.8/27.9
L403	6200002041	S.COI NLV25T-101J	T	81.1/19.7
L404	6130002961	S.COI #617DB-1327=P3	T	84.4/27.9
L406	6130002961	S.COI #617DB-1327=P3	T	77.6/24.2
L421	6200004590	S.COI MLF1608D R18K-T	T	86.4/21.7
L501	6200004660	S.COI MLF1608A 1R8K-T	T	93.4/35.7
L503	6200004660	S.COI MLF1608A 1R8K-T	T	83.2/31.1
L507	6200001981	S.COI NLV25T-1R0J	T	78.7/34.4
L508	6200010650	S.COI C2520C-R12G-A (0.12U)	T	86.3/34.4
L509	6200004660	S.COI MLF1608A 1R8K-T	T	93.1/38.7
L511	6200004150	S.COI MLF1608D 47NM-T	T	92.7/37.2
L512	6200009610	S.COI MLG1608B 39NJ-T	B	89.6/32.8
L601	6200004660	S.COI MLF1608A 1R8K-T	B	85.7/38.6
L603	6200004660	S.COI MLF1608A 1R8K-T	T	89.3/42.2
L604	6150005330	S.COI LS-548 PKI-4185	T	90.5/46.2
L605	6200004660	S.COI MLF1608A 1R8K-T	T	93.1/39.9
L607	6200011800	S.COI C2520C-47NG-A	B	85.6/43.5
L609	6200011800	S.COI C2520C-47NG-A	B	81.5/46
L610	6200004660	S.COI MLF1608A 1R8K-T	B	78.1/44.8
L611	6200004660	S.COI MLF1608A 1R8K-T	T	68/46.3
L612	6150005330	S.COI LS-548 PKI-4185	T	72.2/42.4
L701	6150005350	S.COI LS-550 PKI-4187	T	62.9/48.6
L702	6150005340	S.COI LS-549 PKI-4186	T	54.8/45.4
L703	6150005350	S.COI LS-550 PKI-4187	T	55.3/59.5
L704	6200004940	S.COI MLF1608D R27K-T	T	62.3/59.6
L705	6200009920	S.COI C2012C-R10G-A	T	61.8/41.7
L801	6140002810	S.COI LR-317	T	68.6/61.3
L802	6200005190	S.COI MLF1608D R56K-T	T	89/58.4
L803	6140002810	S.COI LR-317	T	79.6/60.1
L804	6200005011	S.COI NLV25T-100J	T	57.5/69.1
L805	6200009871	S.COI NLV25T-120J	T	57.6/71.9
L806	6200004741	S.COI NLV25T-1R2J	T	63.1/71.2
L807	6200004741	S.COI NLV25T-1R2J	T	63.2/66.7
L808	6200004100	S.COI MLF1608D 68NM-T	T	86.1/61.6
L901	6200003520	S.COI ELJFB 102K-F	B	37.6/72.4
L904	6150005360	S.COI LS-551 PKI-4188-1	T	51.6/70.9
L905	6200003520	S.COI ELJFB 102K-F	B	40.2/59.9
L906	6200003520	S.COI ELJFB 102K-F	B	33.6/62.4
L908	6200003520	S.COI ELJFB 102K-F	B	31.5/69.7
L1003	6200003520	S.COI ELJFB 102K-F	B	12.9/75.3
L1102	6200002041	S.COI NLV25T-101J	T	7.1/89.7
L1301	6200002041	S.COI NLV25T-101J	T	8.3/55.8
L1302	6200002041	S.COI NLV25T-101J	T	11.8/58.5
L1303	6200002041	S.COI NLV25T-101J	T	4.8/55.8
L1401	6200002041	S.COI NLV25T-101J	B	43.3/79.6
L1402	6200004790	S.COI MLF1608D R47K-T	B	44.1/70.4
L1403	6200002041	S.COI NLV25T-101J	B	43/77.1
L1404	6200003711	S.COI NLV25T-2R7J	B	18.2/80.4
L1405	6200002041	S.COI NLV25T-101J	B	17.7/85
L1491	6200010870	S.COI C2520C-R33G-A (0.33U) [EUR]	B	84.9/30.7
	6200010870	S.COI C2520C-R33G-A (0.33U) [FRA]		
	6200010870	S.COI C2520C-R33G-A (0.33U) [ESP]		
	6200010740	S.COI C2520C-R27G-A [USA]		
	6200010870	S.COI C2520C-R33G-A (0.33U) [EXP]		

[MAIN UNIT]

REF NO.	PARTS NO.	DESCRIPTION	M.	H/V LOCATION
L1491	6200010870	S.COI C2520C-R33G-A (0.33U) [ITR]	B	84.9/30.7
	6200010870	S.COI C2520C-R33G-A (0.33U) [UK]		
	6200010740	S.COI C2520C-R27G-A [KOR]		
	6200010870	S.COI C2520C-R33G-A (0.33U) [AUS]		
	6200010870	S.COI C2520C-R33G-A (0.33U) [CHN]		
L1492	6200010870	S.COI C2520C-R33G-A (0.33U) [EUR]	B	80.6/33.1
	6200010870	S.COI C2520C-R33G-A (0.33U) [FRA]		
	6200010870	S.COI C2520C-R33G-A (0.33U) [ESP]		
	6200010740	S.COI C2520C-R27G-A [USA]		
	6200010870	S.COI C2520C-R33G-A (0.33U) [EXP]		
	6200010870	S.COI C2520C-R33G-A (0.33U) [ITR]		
	6200010870	S.COI C2520C-R33G-A (0.33U) [UK]		
	6200010740	S.COI C2520C-R27G-A [KOR]		
	6200010870	S.COI C2520C-R33G-A (0.33U) [AUS]		
	6200010870	S.COI C2520C-R33G-A (0.33U) [CHN]		
L1501	6200005011	S.COI NLV25T-100J	B	91.1/27.1
L1502	6200012170	S.COI MLG1608SR18J-T	B	79.4/38.2
L1503	6200012170	S.COI MLG1608SR18J-T	B	82/37.5
L1504	6200005011	S.COI NLV25T-100J	B	75.6/43.4
L1505	6200005190	S.COI MLF1608D R56K-T	B	73.2/48.5
L1506	6150005080	S.COI LS-535 (4KMH) [EUR]	T	68.7/55.4
	6150005080	S.COI LS-535 (4KMH) [FRA]		
	6150005080	S.COI LS-535 (4KMH) [ESP]		
	6150005070	S.COI LS-534 (4KMH) [USA]		
	6150005080	S.COI LS-535 (4KMH) [EXP]		
	6150005080	S.COI LS-535 (4KMH) [ITR]		
	6150005080	S.COI LS-535 (4KMH) [UK]		
	6150005070	S.COI LS-534 (4KMH) [KOR]		
	6150005080	S.COI LS-535 (4KMH) [AUS]		
	6150005080	S.COI LS-535 (4KMH) [CHN]		
L1507	6200005031	S.COI NLV25T-180J	B	71.7/62.2
L1508	6200005021	S.COI NLV25T-150J	B	77.3/79.5
L1951	6180003610	S.COI 7E10L-101M 100U 0	B	34.6/10.9
L1952	6180003610	S.COI 7E10L-101M 100U 0	B	54.7/113.3
L1953	6180003610	S.COI 7E10L-101M 100U 0	B	14/111.9
L1954	6180003610	S.COI 7E10L-101M 100U 0	B	24.4/19.8
L2001	6200005011	S.COI NLV25T-100J	B	72.5/16.4
L2002	6200002041	S.COI NLV25T-101J	B	84.5/3.8
L2003	6200002041	S.COI NLV25T-101J	B	81.1/4.3
L2004	6200002041	S.COI NLV25T-101J	B	76.3/20.4
L2006	6200002041	S.COI NLV25T-101J	B	64.2/12.8
L2007	6200002041	S.COI NLV25T-101J	B	70.9/3.8
L2008	6200002041	S.COI NLV25T-101J	B	67.9/6.1
L2009	6200005011	S.COI NLV25T-100J	B	70.8/10.6
L2010	6200002041	S.COI NLV25T-101J	B	60.7/13.7
L2011	6200011300	S.COI EXCML16A270U	T	86.6/9.1
L2012	6200011300	S.COI EXCML16A270U	B	84.7/21.9
L2013	6200002041	S.COI NLV25T-101J	B	71.8/19.4
L2015	6200002041	S.COI NLV25T-101J	B	52.5/10.4
L2016	6200002041	S.COI NLV25T-101J	B	59.2/11.2
L2017	6200002041	S.COI NLV25T-101J	B	57/14
L2018	6200002041	S.COI NLV25T-101J	B	19.7/129.4
L2019	6200002041	S.COI NLV25T-101J	T	22.2/126.9
L2020	6200002041	S.COI NLV25T-101J	B	27.9/131.3
L2021	6200005011	S.COI NLV25T-100J	B	27.1/126.5
L2022	6200002041	S.COI NLV25T-101J	B	22.6/127.6
L2023	6200002041	S.COI NLV25T-101J	B	23.2/131.3
L2024	6200002041	S.COI NLV25T-101J	T	12.7/128.2
L2025	6200002041	S.COI NLV25T-101J	B	87.5/6.2
L2026	6200002041	S.COI NLV25T-101J	B	77.6/5
L2027	6200002041	S.COI NLV25T-101J	B	76.5/12.2
L2028	6200002041	S.COI NLV25T-101J	B	67.4/10.3
L2029	6200002041	S.COI NLV25T-101J	B	64/10.3
L2030	6200002041	S.COI NLV25T-101J	B	67.5/3.6
L2031	6200002041	S.COI NLV25T-101J	B	76.5/14.7
L2032	6200002041	S.COI NLV25T-101J	B	66.1/15.3
L2033	6200011300	S.COI EXCML16A270U	B	69.6/14.5
L2034	6200009300	S.COI ELJPA 10KF 10U	B	67.8/19.3
L2035	6200002041	S.COI NLV25T-101J	B	59.8/18.4
L2036	6200002041	S.COI NLV25T-101J	B	64.1/3.8
L2037	6200002041	S.COI NLV25T-101J	B	88.3/3.7
L2041	6180003610	S.COI 7E10L-101M 100U 0	B	62.6/86.9
L2042	6200002861	S.COI NLV25T-4R7J	B	62.9/79.3
L2053	6200002041	S.COI NLV25T-101J	B	28.7/90.9
L2151	6200002041	S.COI NLV25T-101J	B	36.9/121
L2152	6200002041	S.COI NLV25T-101J	B	52.3/14.7
L2201	6200005011	S.COI NLV25T-100J	T	27.3/125.8
L2202	6200005011	S.COI NLV25T-100J	T	17/124.3
L2231	6200002041	S.COI NLV25T-101J	T	34/104.2
L2256	6200002041	S.COI NLV25T-101J	T	15/103.4
L2257	6200002041	S.COI NLV25T-101J	T	10.5/89.7
L2260	6200002041	S.COI NLV25T-101J	T	68.5/110.9
L2263	6200002041	S.COI NLV25T-101J	T	62.3/99.4
L2264	6200002041	S.COI NLV25T-101J	T	62.3/96.9
L2265	6200002041	S.COI NLV25T-101J	T	62.4/94.3
L2266	6200002041	S.COI NLV25T-101J	T	62.4/91.5
L2267	6200002041	S.COI NLV25T-101J	T	66/89.6
L2268	6200002041	S.COI NLV25T-101J	T	62.4/87.1
L2272	6200002041	S.COI NLV25T-101J	T	71.1/90.2
L2402	6200002041	S.COI NLV25T-101J	B	89.4/98
L2403	6200002041	S.COI NLV25T-101J	B	89.2/84
L2404	6200002			

[MAIN UNIT]

REF NO.	PARTS NO.	DESCRIPTION	M.	H/V LOCATION
R1	7030011400	S.RES ERJ2GEJ 5R6 X (5.6)	T	79.7/17
R2	7030009270	S.RES ERJ2GEJ 821 X (820)	T	81.3/17
R3	7030009270	S.RES ERJ2GEJ 821 X (820)	T	79.7/17.9
R5	7030010090	S.RES ERJ2GEJ 180 X (18)	T	74.2/16.7
R6	7030008280	S.RES ERJ2GEJ 271 X (270)	T	74.8/15.8
R7	7030008280	S.RES ERJ2GEJ 271 X (270)	T	73.2/15.8
R8	7030009200	S.RES ERJ2GEJ 390 X (39)	T	73/18.5
R9	7030003400	S.RES ERJ3GEJ 471 V (470)	T	69.9/13.3
R10	7030005120	S.RES ERJ2GEJ 102 X (1K)	T	72.8/14.9
R11	7030005300	S.RES ERJ2GEJ 150 X (15)	T	62.1/15.9
R12	7030010040	S.RES ERJ2GEJ-JPW	T	62.9/13.8
R13	7030005090	S.RES ERJ2GEJ 104 X (100K)	T	66.8/20.6
R15	7030005090	S.RES ERJ2GEJ 104 X (100K)	T	70.4/10.4
R16	7030003860	S.RES ERJ3GE JPW V	T	62.4/12.3
R17	7030005090	S.RES ERJ2GEJ 104 X (100K)	T	76.4/15.8
R18	7030007270	S.RES ERJ2GEJ 151 X (150)	T	44.2/17.2
R19	7030003860	S.RES ERJ3GE JPW V	T	50.4/14.6
R20	7030009530	S.RES ERJ2GEJ 270 X (27)	T	69.5/19.7
R21	7030009530	S.RES ERJ2GEJ 270 X (27)	T	65.4/22.8
R22	7030010040	S.RES ERJ2GEJ-JPW	T	78.1/13.8
R23	7030007290	S.RES ERJ2GEJ 222 X (2.2K)	T	79.8/13.8
R24	7030005010	S.RES ERJ2GEJ 681 X (680)	T	78.1/12.9
R25	7030005120	S.RES ERJ2GEJ 102 X (1K)	B	79.2/18.5
R27	7030005120	S.RES ERJ2GEJ 102 X (1K)	B	81.3/8.5
R29	7030004980	S.RES ERJ2GEJ 101 X (100)	T	73.1/11.3
R30	7030009160	S.RES ERJ2GEJ 181 X (180)	T	46.4/15.4
R31	7030007270	S.RES ERJ2GEJ 151 X (150)	T	42.6/17.2
R32	7030009200	S.RES ERJ2GEJ 390 X (39)	T	44.1/18.2
R35	7030003860	S.RES ERJ3GE JPW V	T	59.9/17.8
	7030003860	S.RES ERJ3GE JPW V	[EUR]	
	7030003860	S.RES ERJ3GE JPW V	[FRA]	
	7030003860	S.RES ERJ3GE JPW V	[ESP]	
	7030003860	S.RES ERJ3GE JPW V	[USA]	
	7030003860	S.RES ERJ3GE JPW V	[EXP]	
	7030003860	S.RES ERJ3GE JPW V	[ITR]	
	7030003860	S.RES ERJ3GE JPW V	[UK]	
	7030003860	S.RES ERJ3GE JPW V	[KOR]	
	7030003860	S.RES ERJ3GE JPW V	[CHN]	
R101	7030005050	S.RES ERJ2GEJ 103 X (10K)	T	13.2/16
R102	7030005120	S.RES ERJ2GEJ 102 X (1K)	T	11.9/14.6
R103	7030005050	S.RES ERJ2GEJ 103 X (10K)	T	10.3/14.6
R104	7030005090	S.RES ERJ2GEJ 104 X (100K)	T	15.7/13.4
R105	7030005580	S.RES ERJ2GEJ 560 X (56)	T	15.7/22.2
R106	7030005000	S.RES ERJ2GEJ 471 X (470)	T	13.2/20.5
R107	7030005000	S.RES ERJ2GEJ 471 X (470)	T	10.8/22.1
R108	7030005000	S.RES ERJ2GEJ 471 X (470)	T	10.8/22.1
R111	7030005000	S.RES ERJ2GEJ 471 X (470)	T	10.8/21.2
R112	7030005090	S.RES ERJ2GEJ 104 X (100K)	T	25.6/12.5
R113	7030005090	S.RES ERJ2GEJ 104 X (100K)	T	26.8/15.7
R114	7030009280	S.RES ERJ2GEJ 391 X	B	33.1/23.4
R115	7030009280	S.RES ERJ2GEJ 391 X	B	34.1/22.2
R116	7030009280	S.RES ERJ2GEJ 391 X	T	22.3/21.3
R117	7030009280	S.RES ERJ2GEJ 391 X	T	20.7/21.3
R118	7030009280	S.RES ERJ2GEJ 391 X	B	40.9/23.2
R119	7030009280	S.RES ERJ2GEJ 391 X	B	40.9/23.2
R120	7030005090	S.RES ERJ2GEJ 104 X (100K)	B	50.3/23.5
R121	7030005090	S.RES ERJ2GEJ 104 X (100K)	T	44/22.2
R122	7030009280	S.RES ERJ2GEJ 391 X	T	7.8/20.3
R123	7030009280	S.RES ERJ2GEJ 391 X	T	7.8/19.4
R125	7030009280	S.RES ERJ2GEJ 391 X	T	35.5/20.2
R126	7030009280	S.RES ERJ2GEJ 391 X	T	27.4/8
R127	7030009280	S.RES ERJ2GEJ 391 X	T	25.4/4.8
R128	7030009280	S.RES ERJ2GEJ 391 X	T	35.5/19.3
R202	7030005090	S.RES ERJ2GEJ 104 X (100K)	T	18.1/31.2
R203	7030005090	S.RES ERJ2GEJ 104 X (100K)	T	42.9/59.9
R204	7030005090	S.RES ERJ2GEJ 104 X (100K)	B	42.9/54.3
R205	7030009280	S.RES ERJ2GEJ 391 X	T	19.4/54.2
R206	7030005090	S.RES ERJ2GEJ 104 X (100K)	B	42.9/51.4
R207	7030005090	S.RES ERJ2GEJ 104 X (100K)	B	42.9/50.5
R208	7030005090	S.RES ERJ2GEJ 104 X (100K)	B	46.4/45
R216	7030005090	S.RES ERJ2GEJ 104 X (100K)	B	44.2/43.3
R217	7030005050	S.RES ERJ2GEJ 103 X (10K)	T	18.1/30.3
R218	7030004970	S.RES ERJ2GEJ 470 X (47)	T	21.9/29.9
R225	7030005050	S.RES ERJ2GEJ 103 X (10K)	T	19.1/29.1
R226	7030009280	S.RES ERJ2GEJ 391 X	T	17.6/54.2
R227	7030005120	S.RES ERJ2GEJ 102 X (1K)	T	30.9/30.9
R228	7030009140	S.RES ERJ2GEJ 272 X (2.7K)	T	30.9/29.1
R301	7030009280	S.RES ERJ2GEJ 391 X	T	44.5/28.8
R302	7030009280	S.RES ERJ2GEJ 391 X	T	38.6/27.8
R303	7030004970	S.RES ERJ2GEJ 470 X (47)	T	52.5/38.9
R304	7030004980	S.RES ERJ2GEJ 101 X (100)	T	55.1/35.6
R305	7030005120	S.RES ERJ2GEJ 102 X (1K)	T	59.9/33.8
R306	7030008280	S.RES ERJ2GEJ 271 X (270)	T	55.3/28.7
R307	7030004980	S.RES ERJ2GEJ 101 X (100)	T	56.7/35.6
R308	7030007290	S.RES ERJ2GEJ 222 X (2.2K)	T	59.2/30.1
R309	7030008280	S.RES ERJ2GEJ 271 X (270)	T	58.5/29.1
R310	7030005090	S.RES ERJ2GEJ 104 X (100K)	T	50.1/31.7
R311	7030009280	S.RES ERJ2GEJ 391 X	T	65.3/31.3
R312	7030009280	S.RES ERJ2GEJ 391 X	T	63.7/31.3
R314	7030009280	S.RES ERJ2GEJ 391 X	T	73.3/32.5
R315	7030009280	S.RES ERJ2GEJ 391 X	T	74.8/33.8
R401	7030010040	S.RES ERJ2GEJ-JPW	T	75/29.5
R402	7030010040	S.RES ERJ2GEJ-JPW	T	75/27.7
R403	7030004980	S.RES ERJ2GEJ 101 X (100)	T	76.7/29.6
R404	7030010040	S.RES ERJ2GEJ-JPW	T	71.9/23.1
R405	7030004980	S.RES ERJ2GEJ 101 X (100)	T	86.8/23.8
R406	7030005580	S.RES ERJ2GEJ 560 X (56)	T	73.1/30.6
R407	7030005580	S.RES ERJ2GEJ 560 X (56)	T	71.9/24.9
R408	7030010040	S.RES ERJ2GEJ-JPW	T	83.3/19.2
R411	7030007260	S.RES ERJ2GEJ 330 X (33)	T	80/29.5

[MAIN UNIT]

REF NO.	PARTS NO.	DESCRIPTION	M.	H/V LOCATION
R412	7030007260	S.RES ERJ2GEJ 330 X (33)	T	80/26.8
R414	7030004980	S.RES ERJ2GEJ 101 X (100)	T	78.3/29.6
R416	7030010090	S.RES ERJ2GEJ 180 X (18)	T	88.3/24.4
R417	7030008280	S.RES ERJ2GEJ 271 X (270)	T	89.2/25.3
R418	7030008280	S.RES ERJ2GEJ 271 X (270)	T	88/22.8
R421	7030010090	S.RES ERJ2GEJ 180 X (18)	B	88.5/20.2
R422	7030008280	S.RES ERJ2GEJ 271 X (270)	B	90.1/20.2
R423	7030008280	S.RES ERJ2GEJ 271 X (270)	B	90.1/19.3
R424	7030005530	S.RES ERJ2GEJ 100 X (10)	T	88.5/21.6
R501	7030005120	S.RES ERJ2GEJ 102 X (1K)	T	91.3/35.6
R502	7030005120	S.RES ERJ2GEJ 102 X (1K)	T	92.9/34.4
R509	7030005580	S.RES ERJ2GEJ 560 X (56)	T	83.4/33.1
R510	7030010040	S.RES ERJ2GEJ-JPW	T	83.4/34.1
R512	7030004980	S.RES ERJ2GEJ 101 X (100)	T	81.7/34.1
R517	7030010040	S.RES ERJ2GEJ-JPW	B	80/31
R518	7030007290	S.RES ERJ2GEJ 222 X (2.2K)	T	79.5/37
R519	7030007290	S.RES ERJ2GEJ 222 X (2.2K)	T	79.5/38.8
R520	7030005120	S.RES ERJ2GEJ 102 X (1K)	T	89.1/39.2
R521	7030005000	S.RES ERJ2GEJ 471 X (470)	T	84.2/40.4
R523	7030005120	S.RES ERJ2GEJ 102 X (1K)	T	91.3/34.7
R524	7030005120	S.RES ERJ2GEJ 102 X (1K)	B	86.9/37
R601	7030005000	S.RES ERJ2GEJ 471 X (470)	B	88.5/40
R602	7030005000	S.RES ERJ2GEJ 471 X (470)	T	91/39.6
R603	7030005000	S.RES ERJ2GEJ 471 X (470)	T	89.1/41
R604	7030005000	S.RES ERJ2GEJ 471 X (470)	B	78.6/45.9
R605	7030010040	S.RES ERJ2GEJ-JPW	T	68.2/45.2
R606	7030005090	S.RES ERJ2GEJ 104 X (100K)	T	67.1/47.4
R607	7030005120	S.RES ERJ2GEJ 102 X (1K)	T	66.6/45.2
R701	7030005220	S.RES ERJ2GEJ 223 X (22K)	T	61.1/53
R702	7030005120	S.RES ERJ2GEJ 102 X (1K)	T	64.2/43.9
R703	7030004970	S.RES ERJ2GEJ 470 X (47)	T	50.8/44.1
R705	7030004990	S.RES ERJ2GEJ 221 X (220)	T	59/51.5
R706	7030009270	S.RES ERJ2GEJ 821 X (820)	T	64.5/55.9
R707	7030004980	S.RES ERJ2GEJ 101 X (100)	T	59.5/57
R708	7030007290	S.RES ERJ2GEJ 222 X (2.2K)	T	63.9/58.6
R709	7030005210	S.RES ERJ2GEJ 822 X (8.2K)	T	59.5/55.1
R710	7030005120	S.RES ERJ2GEJ 102 X (1K)	T	59.8/62.5
R711	7030009140	S.RES ERJ2GEJ 272 X (2.7K)	T	50.5/51.4
R712	7030005120	S.RES ERJ2GEJ 102 X (1K)	T	51.2/50.5
R713	7030005050	S.RES ERJ2GEJ 103 X (10K)	T	57.1/51.5
R715	7030004970	S.RES ERJ2GEJ 470 X (47)	T	52.1/54.1
R716	7030005710	S.RES ERJ2GEJ 121 X (120)	T	51.3/57.5
R717	7030007300	S.RES ERJ2GEJ 332 X (3.3K)	T	52.1/51.4
R718	7510001461	S.THE NTCG16 3NH 471JT	T	63.3/54
R801	7030008280	S.RES ERJ2GEJ 271 X (270)	T	86.8/55.2
R802	7030005120	S.RES ERJ2GEJ 102 X (1K)	T	65.3/60.9
R803	7030005120	S.RES ERJ2GEJ 102 X (1K)	T	71.9/64.9
R804	7030005530	S.RES ERJ2GEJ 100 X (10)	T	91.1/57.1
R805	7030010090	S.RES ERJ2GEJ 180 X (18)	T	84.7/54.3
R806	7030008280	S.RES ERJ2GEJ 271 X (270)	T	85.2/55.2
R807	7030005120	S.RES ERJ2GEJ 102 X (1K)	T	62.8/64.6
R808	7030004970	S.RES ERJ2GEJ 470 X (47)	T	62.3/69.4
R809	7030008280	S.RES ERJ2GEJ 271 X (270)	T	82.8/60.6
R810	7030010090	S.RES ERJ2GEJ 180 X (18)	T	84.4/60.6
R811	7030008280	S.RES ERJ2GEJ 271 X (270)	T	82.8/59.7
R904	7030003860	S.RES ERJ3GE JPW V	T	36.5/68.1
R905	7030004980	S.RES ERJ2GEJ 101 X (100)	T	39.2/64.6
R906	7030007290	S.RES ERJ2GEJ 222 X (2.2K)	T	39.2/66.5
R908	7030005000	S.RES ERJ2GEJ 471 X (470)	T	35.6/61.9
R909	7030008410	S.RES ERJ2GEJ 392 X (3.9K)	T	34.2/68.4
R912	7030005210	S.RES ERJ2GEJ 822 X (8.2K)	T	34.2/66.6
R913	7030007300	S.RES ERJ2GEJ 332 X (3.3K)	T	40.5/75
R914	7030009290	S.RES ERJ2GEJ 562 X (5.6K)	T	35.6/73.4
R915	7030007290	S.RES ERJ2GEJ 222 X (2.2K)	T	36.6/70.9
R916	7030005050	S.RES ERJ2GEJ 103 X (10K)	T	37.2/75.4
R917	7030004970	S.RES ERJ2GEJ 470 X (47)	T	34.2/69.3
R918	7030007290	S.RES ERJ2GEJ 222 X (2.2K)	B	31.4/72.1
R919	7030004980	S.RES ERJ2GEJ 101 X (100)	T	31.5/72.1
R1009	7030009290	S.RES ERJ2GEJ 562 X (5.6K)	T	25.8/72.9
R1018	7030007290	S.RES ERJ2GEJ 222 X (2.2K)	T	20.3/75
R1019	7030005050	S.RES ERJ2GEJ 103 X (10K)	T	20.3/76.9
R1020	7030005000	S.RES ERJ2GEJ 471 X (470)	T	12.7/77.6
R1022	7510001461	S.THE NTCG16 3NH 471JT	T	14.8/76.8
R1023	7030008370	S.RES ERJ2GEJ 561 X (560)	T	15.2/77.8
R1024	7030004980	S.RES ERJ2GEJ 101 X (100)	T	12.7/74.9
R1025	7030007260	S.RES ERJ2GEJ 330 X (33)	T	12.7/76.7
R1027	7030005120	S.RES ERJ2GEJ 102 X (1K)	T	4.6/87.8
R1201	7030005000	S.RES ERJ2GEJ 471 X (470)	T	25.7/77.6
R1202	7030005240	S.RES ERJ2GEJ 473 X (47K)	T	24/78.5
R1203	7030005240	S.RES ERJ2GEJ 473 X (47K)	T	25.6/78.5
R1204	7030005240	S.RES ERJ2GEJ 473 X (47K)	T	20.2/79.2
R1205	7030005000	S.RES ERJ2GEJ 471 X (470)	T	20.2/78.3
R1206	7030005090	S.RES ERJ2GEJ 104 X (100K)	T	21.8/79.2
R1207	7030005240	S.RES ERJ2GEJ 473 X (47K)	T	17.9/83.6
R1208	7030004980	S.RES ERJ2GEJ 101 X (100)	T	9.4/79.8
R1209	7030004980	S.RES ERJ2GEJ 101 X (100)	T	16.4/79.9
R1211	7030005120	S.RES ERJ2GEJ 102 X (1K)		

[MAIN UNIT]

REF NO.	PARTS NO.	DESCRIPTION	M.	H/V LOCATION
R1306	7030005120	S.RES ERJ2GEJ 102 X (1K)	T	10.9/56.8
R1308	7030007300	S.RES ERJ2GEJ 332 X (3.3K)	T	12.9/67.3
R1309	7030005120	S.RES ERJ2GEJ 102 X (1K)	T	11.3/66.4
R1310	7510001451	S.THE NTCG16 4BH 472JT	T	12.2/68.4
R1401	7030005120	S.RES ERJ2GEJ 102 X (1K)	B	45.3/72.3
R1402	7030008010	S.RES ERJ2GEJ 123 X (12K)	B	43.6/72.3
R1403	7030007290	S.RES ERJ2GEJ 222 X (2.2K)	B	44.5/73.4
R1404	7030007280	S.RES ERJ2GEJ 331 X (330)	B	44.5/75.2
R1405	7030004970	S.RES ERJ2GEJ 470 X (47)	B	42/71.5
R1406	7030005290	S.RES ERJ2GEJ 682 X (6.8K)	B	38.7/79.9
R1407	7030005120	S.RES ERJ2GEJ 102 X (1K)	B	38.7/77.9
R1408	7030007280	S.RES ERJ2GEJ 331 X (330)	B	38.7/80.8
R1409	7030004970	S.RES ERJ2GEJ 470 X (47)	B	34.6/80
R1414	7030007340	S.RES ERJ2GEJ 153 X (15K)	B	20.2/76.4
R1416	7030008410	S.RES ERJ2GEJ 392 X (3.9K)	B	19.4/83
R1420	7030004990	S.RES ERJ2GEJ 221 X (220)	B	25/76.8
R1421	7030007270	S.RES ERJ2GEJ 151 X (150)	B	23.2/75.9
R1422	7030004990	S.RES ERJ2GEJ 221 X (220)	B	23.2/76.8
R1501	7030010040	S.RES ERJ2GEJ-JPW	B	72.4/38.2
R1502	7030005100	S.RES ERJ2GEJ 154 X (150K)	B	86.4/55.3
R1503	7030005100	S.RES ERJ2GEJ 154 X (150K)	B	85.7/54.1
R1504	7030004970	S.RES ERJ2GEJ 470 X (47)	B	72.4/40.3
R1505	7030007290	S.RES ERJ2GEJ 222 X (2.2K)	B	71.8/53.9
R1506	7030007350	S.RES ERJ2GEJ 393 X (39K)	B	85.7/52.3
R1507	7030007350	S.RES ERJ2GEJ 393 X (39K)	B	85.7/53.2
R1508	7030005220	S.RES ERJ2GEJ 223 X (22K)	B	74.2/61.6
R1509	7030006610	S.RES ERJ2GEJ 394 X (390K)	B	85.9/59
R1510	7030005050	S.RES ERJ2GEJ 103 X (10K) [USA] only	B	76.6/61.9
R1511	7030005590	S.RES ERJ2GEJ 680 X (68)	B	85.8/60.8
R1512	7030005120	S.RES ERJ2GEJ 102 X (1K)	B	71.5/73.7
R1513	7030007280	S.RES ERJ2GEJ 331 X (330)	B	73.1/73.7
R1514	7030007290	S.RES ERJ2GEJ 222 X (2.2K)	B	73.4/53
R1515	7030007290	S.RES ERJ2GEJ 222 X (2.2K)	B	71.8/53
R1516	7030004970	S.RES ERJ2GEJ 470 X (47)	B	82.5/35.3
R1521	7030005090	S.RES ERJ2GEJ 104 X (100K)	B	86.5/50.3
R1522	7030005240	S.RES ERJ2GEJ 473 X (47K)	B	86.7/46.8
R1523	7030005120	S.RES ERJ2GEJ 102 X (1K)	B	77.3/39.5
R1524	7030005120	S.RES ERJ2GEJ 102 X (1K)	B	81.9/40.3
R1525	7030007300	S.RES ERJ2GEJ 332 X (3.3K)	B	81.9/42.2
R1526	7030005120	S.RES ERJ2GEJ 102 X (1K)	B	83.5/40.5
R1602	7030005120	S.RES ERJ2GEJ 102 X (1K)	T	6.3/54
R1603	7030010040	S.RES ERJ2GEJ-JPW	T	13/49.6
R1604	7030007290	S.RES ERJ2GEJ 222 X (2.2K)	T	13/50.5
R1605	7030005090	S.RES ERJ2GEJ 104 X (100K)	T	8.8/46.9
R1606	7030005070	S.RES ERJ2GEJ 683 X (68K)	T	6.1/46.6
R1607	7030005070	S.RES ERJ2GEJ 683 X (68K)	T	5.1/42.1
R1608	7030005090	S.RES ERJ2GEJ 104 X (100K)	T	10.4/47.8
R1609	7030007320	S.RES ERJ2GEJ 225 X (2.2M)	T	10.4/46
R1610	7030005060	S.RES ERJ2GEJ 333 X (33K)	T	4.5/43.5
R1611	7030005230	S.RES ERJ2GEJ 334 X (330K)	T	8.8/47.8
R1612	7030005060	S.RES ERJ2GEJ 333 X (33K)	T	3.4/42.3
R1613	7030003860	S.RES ERJ3GE JPW V	T	6.7/48.7
R1614	7030007310	S.RES ERJ2GEJ 155 X (1.5M)	T	6.1/45.7
R1615	7030005040	S.RES ERJ2GEJ 472 X (4.7K)	T	4.2/35.4
R1616	7030005090	S.RES ERJ2GEJ 104 X (100K)	T	6.7/35.4
R1617	7030005720	S.RES ERJ2GEJ 563 X (56K)	T	3.4/38.2
R1618	7310005020	S.TRI RH03ADC14X (10K) 1	T	3.5/46.3
R1619	7030005080	S.RES ERJ2GEJ 823 X (82K) [EUR]	T	2.6/43.3
	7030005080	S.RES ERJ2GEJ 823 X (82K) [FRA]		
	7030005080	S.RES ERJ2GEJ 823 X (82K) [ESP]		
	7030005080	S.RES ERJ2GEJ 823 X (82K) [USA]		
	7030005080	S.RES ERJ2GEJ 823 X (82K) [EXP]		
	7030005080	S.RES ERJ2GEJ 823 X (82K) [ITR]		
	7030005080	S.RES ERJ2GEJ 823 X (82K) [UK]		
	7030005080	S.RES ERJ2GEJ 823 X (82K) [KOR]		
	7030005720	S.RES ERJ2GEJ 563 X (56K) [AUS]		
	7030005080	S.RES ERJ2GEJ 823 X (82K) [CHN]		
R1620	7030008290	S.RES ERJ2GEJ 183 X (18K)	T	3.4/37.3
R1621	7030005160	S.RES ERJ2GEJ 105 X (1M)	T	6.7/37.2
R1622	7030010040	S.RES ERJ2GEJ-JPW	T	5/37.3
R1623	7030005000	S.RES ERJ2GEJ 471 X (470)	T	12/46.8
R1624	7030007250	S.RES ERJ2GEJ 220 X (22)	T	14.9/38.3
R1625	7030004990	S.RES ERJ2GEJ 221 X (220)	T	13.6/32.6
R1626	7030005050	S.RES ERJ2GEJ 103 X (10K)	T	10.3/34.5
R1627	7030007320	S.RES ERJ2GEJ 225 X (2.2M)	T	10.3/35.4
R1628	7030005120	S.RES ERJ2GEJ 102 X (1K)	T	4.9/30.8
R1629	7030005050	S.RES ERJ2GEJ 103 X (10K)	T	4.9/29.9
R1630	7030004980	S.RES ERJ2GEJ 101 X (100)	T	8.3/45.7
R1631	7030005090	S.RES ERJ2GEJ 104 X (100K)	T	9.8/37.2
R1634	7030005040	S.RES ERJ2GEJ 472 X (4.7K)	T	10.3/33.6
R1636	7030007320	S.RES ERJ2GEJ 225 X (2.2M)	T	13/31.7
R1637	7030007320	S.RES ERJ2GEJ 225 X (2.2M)	T	12/45.9
R1638	7030008280	S.RES ERJ2GEJ 271 X (270)	T	10.9/48.8
R1639	7030005120	S.RES ERJ2GEJ 102 X (1K)	T	14.6/50.5
R1640	7030005090	S.RES ERJ2GEJ 104 X (100K)	T	10.9/31.6
R1641	7030007320	S.RES ERJ2GEJ 225 X (2.2M)	T	13/30.7
R1642	7030005120	S.RES ERJ2GEJ 102 X (1K)	T	22.9/55.1
R1701	7030009320	S.RES ERJ2GEJ 4R7 X (4.7)	T	48/45.3
R1702	7030007280	S.RES ERJ2GEJ 331 X (330)	B	52.1/44.7
R1703	7030007280	S.RES ERJ2GEJ 331 X (330)	B	53.7/43.8
R1704	7030007280	S.RES ERJ2GEJ 331 X (330)	B	53.7/44.7
R1705	7030009320	S.RES ERJ2GEJ 4R7 X (4.7)	T	48/46.2
R1706	7030007280	S.RES ERJ2GEJ 331 X (330)	B	53.6/64.2
R1707	7030007280	S.RES ERJ2GEJ 331 X (330)	B	55.6/64.8
R1708	7030007280	S.RES ERJ2GEJ 331 X (330)	B	55.6/65.7
R1901	7030005090	S.RES ERJ2GEJ 104 X (100K)	B	20/13.9
R1902	7030011290	S.RES ERJ12YJR8U (1.8)	B	12.4/45.8
R1952	7030009980	S.RES ERJ12RSJR15U	B	42.6/102.3
R1953	7030009980	S.RES ERJ12RSJR15U	B	42.6/98.6

[MAIN UNIT]

REF NO.	PARTS NO.	DESCRIPTION	M.	H/V LOCATION
R1954	7030005170	S.RES ERJ2GEJ 474 X (470K)	B	42.7/111.3
R1955	7030005511	S.RES ERA3YED 303V (30K)	B	44.8/107.3
R1956	7030005110	S.RES ERJ2GEJ 224 X (220K)	B	33.7/105.1
R1957	7030007350	S.RES ERJ2GEJ 393 X (39K)	B	35.3/104.2
R1958	7030005720	S.RES ERJ2GEJ 563 X (56K)	B	35.3/103.3
R1981	7030008240	S.RES ERJ12Y0R00U	B	83.1/109
R2002	7030010040	S.RES ERJ2GEJ-JPW	B	36.9/12.7
R2003	7030008240	S.RES ERJ12Y0R00U	T	55.7/7.9
R2004	7030004990	S.RES ERJ2GEJ 221 X (220)	B	59.8/9.2
R2005	7030004990	S.RES ERJ2GEJ 221 X (220)	B	59.1/3
R2006	7030004990	S.RES ERJ2GEJ 221 X (220)	B	60.7/3.7
R2007	7030004990	S.RES ERJ2GEJ 221 X (220)	B	60.7/4.6
R2008	7030010040	S.RES ERJ2GEJ-JPW	B	34/17.6
R2010	7030010040	S.RES ERJ2GEJ-JPW	B	32.5/15.1
R2011	7030006210	S.RES ERJ12YJ4R7U (4.7)	B	13.1/26.3
R2012	7030005120	S.RES ERJ2GEJ 102 X (1K)	B	32.4/17.3
R2101	7030005090	S.RES ERJ2GEJ 104 X (100K)	T	26/113.8
R2102	7030005090	S.RES ERJ2GEJ 104 X (100K)	T	33.1/114.3
R2103	7030005090	S.RES ERJ2GEJ 104 X (100K)	T	30.7/123.2
R2104	7030005090	S.RES ERJ2GEJ 104 X (100K)	T	28.1/123.2
R2105	7030005090	S.RES ERJ2GEJ 104 X (100K)	T	32.3/118.7
R2106	7030005720	S.RES ERJ2GEJ 563 X (56K)	T	25/115.5
R2107	7030005720	S.RES ERJ2GEJ 563 X (56K)	T	31.5/114.6
R2108	7030005100	S.RES ERJ2GEJ 154 X (150K)	T	30.7/122.3
R2109	7030007350	S.RES ERJ2GEJ 393 X (39K)	T	27.1/122.3
R2110	7030005090	S.RES ERJ2GEJ 104 X (100K)	T	44.3/111.8
R2111	7030005090	S.RES ERJ2GEJ 104 X (100K)	T	44.7/110
R2112	7030005090	S.RES ERJ2GEJ 104 X (100K)	T	54.1/110.8
R2113	7030005090	S.RES ERJ2GEJ 104 X (100K)	T	54.1/111.7
R2114	7030005100	S.RES ERJ2GEJ 154 X (150K)	T	44.7/112.7
R2115	7030005100	S.RES ERJ2GEJ 154 X (150K)	T	44.7/109.1
R2116	7030005100	S.RES ERJ2GEJ 154 X (150K)	T	54.4/109.9
R2117	7030005100	S.RES ERJ2GEJ 154 X (150K)	T	54.1/112.6
R2118	7030005090	S.RES ERJ2GEJ 104 X (100K)	T	54.1/120.6
R2119	7030005090	S.RES ERJ2GEJ 104 X (100K)	T	54.1/121.8
R2120	7030008300	S.RES ERJ2GEJ 184 X (180K)	T	44.8/122.1
R2121	7030008300	S.RES ERJ2GEJ 184 X (180K)	T	42.9/121.3
R2122	7030005100	S.RES ERJ2GEJ 154 X (150K)	T	54.1/119.7
R2123	7030006610	S.RES ERJ2GEJ 394 X (390K)	T	54.2/122.8
R2124	7030005110	S.RES ERJ2GEJ 224 X (220K)	T	44.8/123
R2125	7030005110	S.RES ERJ2GEJ 224 X (220K)	T	44.8/119.4
R2126	7030010040	S.RES ERJ2GEJ-JPW	T	33.1/16.4
R2128	7030005000	S.RES ERJ2GEJ 471 X (470)	T	32.3/123.2
R2129	7030005000	S.RES ERJ2GEJ 471 X (470)	T	54.1/118.8
R2131	7030005090	S.RES ERJ2GEJ 104 X (100K)	B	39.8/122
R2132	7030005090	S.RES ERJ2GEJ 104 X (100K)	T	42.8/115.1
R2133	7030005090	S.RES ERJ2GEJ 104 X (100K)	T	40.6/114.1
R2134	7030005090	S.RES ERJ2GEJ 104 X (100K)	T	36.5/114.1
R2135	7030005090	S.RES ERJ2GEJ 104 X (100K)	T	34.9/114.2
R2136	7030005000	S.RES ERJ2GEJ 471 X (470)	T	26.5/123.2
R2137	7030005230	S.RES ERJ2GEJ 334 X (330K)	T	43.3/123.7
R2138	7030005230	S.RES ERJ2GEJ 334 X (330K)	T	42.9/122.2
R2139	7030004980	S.RES ERJ2GEJ 101 X (100)	T	25/116.4
R2140	7030004980	S.RES ERJ2GEJ 101 X (100)	T	32/115.5
R2141	7030010040	S.RES ERJ2GEJ-JPW	T	44.7/113.6
R2142	7030010040	S.RES ERJ2GEJ-JPW	T	52.7/108.9
R2143	7030010040	S.RES ERJ2GEJ-JPW	T	56/109.9
R2144	7030010040	S.RES ERJ2GEJ-JPW	T	51.3/115.1
R2145	7030010040	S.RES ERJ2GEJ-JPW	T	58.1/123.6
R2146	7030010040	S.RES ERJ2GEJ-JPW	T	46.3/124
R2147	7030010040	S.RES ERJ2GEJ-JPW	T	46/118.5
R2151	7030005240	S.RES ERJ2GEJ 473 X (47K)	T	52.3/101.7
R2152	7030005120	S.RES ERJ2GEJ 102 X (1K)	T	56.5/107.1
R2153	7030005240	S.RES ERJ2GEJ 473 X (47K)	T	24.8/112.5
R2154	7030005120	S.RES ERJ2GEJ 102 X (1K)	T	25.6/111.6
R2155	7030005240	S.RES ERJ2GEJ 473 X (47K)	T	46.1/104.6
R2156	7030005120	S.RES ERJ2GEJ 102 X (1K)	T	46.1/105.5
R2157	7030005530	S.RES ERJ2GEJ 100 X (10)	B	33.3/120.8
R2158	7030005530	S.RES ERJ2GEJ 100 X (10)	B	33.3/119.8
R2159	7030005530	S.RES ERJ2GEJ 100 X (10)	B	35.1/118.3
R2160	7030005530	S.RES ERJ2GEJ 100 X (10)	B	40.7/94.3
R2161	7030005530	S.RES ERJ2GEJ 100 X (10)	B	40.7/95.2
R2162	7030005530	S.RES ERJ2GEJ 100 X (10)	B	30.2/93.8
R2163	7030005530	S.RES ERJ2GEJ 100 X (10)	B	30.9/95.9
R2164	7030005530	S.RES ERJ2GEJ 100 X (10)	B	30.2/94.7
R2165	7030005530	S.RES ERJ2GEJ 100 X (10)	B	29.3/95.9
R2166	7030005530	S.RES ERJ2GEJ 100 X (10)	T	51.8/93.3
R2167	7030005530	S.RES ERJ2GEJ 100 X (10)	T	51.8/94.2
R2168	7030005530	S.RES ERJ2GEJ 100 X (10)	T	51.8/95.1
R2169	7030005120	S.RES ERJ2GEJ 102 X (1K)	T	8.8/118.5
R2170	7030005170	S.RES ERJ2GEJ 474 X (470K)	T	5/104.5
R2171	7030005240	S.RES ERJ2GEJ 473 X (47K)	T	9.7/114.2
R				

[MAIN UNIT]

REF NO.	PARTS NO.	DESCRIPTION	M.	H/V LOCATION
R2215	7030005040	S.RES ERJ2GEJ 472 X (4.7K)	T	11.1/120.6
R2217	7030007280	S.RES ERJ2GEJ 331 X (330)	T	24.9/121.5
R2218	7030007270	S.RES ERJ2GEJ 151 X (150)	T	15.5/127.5
R2219	7030007280	S.RES ERJ2GEJ 331 X (330)	T	17.7/126.1
R2220	7030008280	S.RES ERJ2GEJ 271 X (270)	T	16.1/126.1
R2221	7030005050	S.RES ERJ2GEJ 103 X (10K)	T	9.5/120.5
R2230	7030010900	S.RES ERJ3GEVJ 750 V (75)	T	40.4/105.8
R2231	7030005050	S.RES ERJ2GEJ 103 X (10K)	T	4.5/118.2
R2232	7030005050	S.RES ERJ2GEJ 103 X (10K)	T	54.7/117.5
R2251	7030004990	S.RES ERJ2GEJ 221 X (220)	T	6.1/96.9
R2254	7030004990	S.RES ERJ2GEJ 221 X (220)	B	6.8/100.7
R2255	7030004990	S.RES ERJ2GEJ 221 X (220)	B	6.8/101.6
R2256	7030004990	S.RES ERJ2GEJ 221 X (220)	B	6.8/102.5
R2257	7030004990	S.RES ERJ2GEJ 221 X (220)	B	75.3/109
R2258	7030004990	S.RES ERJ2GEJ 221 X (220)	B	70.9/106.5
R2259	7030004990	S.RES ERJ2GEJ 221 X (220)	B	75.3/107.8
R2260	7030004990	S.RES ERJ2GEJ 221 X (220)	B	71/105.6
R2261	7030004990	S.RES ERJ2GEJ 221 X (220)	B	75.3/106.6
R2262	7030004990	S.RES ERJ2GEJ 221 X (220)	B	71.4/104.5
R2263	7030004990	S.RES ERJ2GEJ 221 X (220)	B	75.6/104.5
R2264	7030004990	S.RES ERJ2GEJ 221 X (220)	B	72.2/103.6
R2267	7030004990	S.RES ERJ2GEJ 221 X (220)	T	78.6/104.1
R2268	7030004990	S.RES ERJ2GEJ 221 X (220)	T	78.6/103.2
R2269	7030004990	S.RES ERJ2GEJ 221 X (220)	T	78.6/102.3
R2270	7030004970	S.RES ERJ2GEJ 470 X (47)	T	76.6/101.8
R2271	7030004990	S.RES ERJ2GEJ 221 X (220)	T	76.6/100.9
R2272	7030004990	S.RES ERJ2GEJ 221 X (220)	B	78.1/97.8
R2273	7030004990	S.RES ERJ2GEJ 221 X (220)	B	78.1/98.9
R2274	7030005000	S.RES ERJ2GEJ 471 X (470)	T	14.1/89.7
R2277	7030005090	S.RES ERJ2GEJ 104 X (100K)	T	19.2/89.5
R2278	7030005090	S.RES ERJ2GEJ 104 X (100K)	T	19.2/90.4
R2279	7030005120	S.RES ERJ2GEJ 102 X (1K)	T	66.2/107
R2280	7030004980	S.RES ERJ2GEJ 101 X (100)	B	69.7/110.2
R2281	7030004990	S.RES ERJ2GEJ 221 X (220)	T	7.1/101.5
R2301	7030007250	S.RES ERJ2GEJ 220 X (22)	T	28.3/106.6
R2302	7030008290	S.RES ERJ2GEJ 183 X (18K)	T	28.9/108
R2303	7030005710	S.RES ERJ2GEJ 121 X (120)	T	31.2/110.8
R2304	7030010900	S.RES ERJ3GEVJ 750 V (75)	T	77.7/112
R2311	7030006101	S.RES ERA3YED 183V (18K)	B	67.6/107.1
R2312	7030006571	S.RES ERA3YED 392V (3.9K)	B	68.5/108.3
R2401	7030005000	S.RES ERJ2GEJ 471 X (470)	B	78.7/29.6
R2402	7030005050	S.RES ERJ2GEJ 103 X (10K)	B	81.3/29.6
R2405	7030010040	S.RES ERJ2GEJ-JPW	T	91.9/5.8
R2406	7030004990	S.RES ERJ2GEJ 221 X (220)	B	90.3/100.7
R2408	7030004970	S.RES ERJ2GEJ 470 X (47)	B	90.3/99.8
R2409	7030004990	S.RES ERJ2GEJ 221 X (220)	B	87.1/68.1
R2410	7030004990	S.RES ERJ2GEJ 221 X (220)	B	90.3/65.5
R2411	7030004990	S.RES ERJ2GEJ 221 X (220)	B	87.3/67.2
R2412	7030004990	S.RES ERJ2GEJ 221 X (220)	B	91.3/68.5
R2413	7030004990	S.RES ERJ2GEJ 221 X (220)	B	87.3/66.3
R2414	7030004990	S.RES ERJ2GEJ 221 X (220)	B	90.3/64.6
R2415	7030004990	S.RES ERJ2GEJ 221 X (220)	B	87.3/65.4
R2416	7030004990	S.RES ERJ2GEJ 221 X (220)	B	90.3/63.7
R2417	7030010040	S.RES ERJ2GEJ-JPW	B	51.4/141.2
R2418	7030010040	S.RES ERJ2GEJ-JPW	T	93.3/7.8
R2501	7030005090	S.RES ERJ2GEJ 104 X (100K)	B	8.3/93.3
R2502	7030005090	S.RES ERJ2GEJ 104 X (100K)	B	8/95.1
R2503	7030008410	S.RES ERJ2GEJ 392 X (3.9K)	B	8/91.5
R2505	7030008410	S.RES ERJ2GEJ 392 X (3.9K)	B	10.6/89.2
R2506	7030005720	S.RES ERJ2GEJ 563 X (56K)	B	9.4/90
R2507	7030004980	S.RES ERJ2GEJ 101 X (100)	B	16.4/89.9
R2508	7030005120	S.RES ERJ2GEJ 102 X (1K)	B	10.4/88.3
R2509	7030005120	S.RES ERJ2GEJ 102 X (1K)	B	15.7/88.3
R2510	7030005120	S.RES ERJ2GEJ 102 X (1K)	B	17.4/92.8
R2513	7030005000	S.RES ERJ2GEJ 471 X (470)	B	15.8/94
R2551	7030005120	S.RES ERJ2GEJ 102 X (1K)	B	42.9/123.2
R2552	7030005120	S.RES ERJ2GEJ 102 X (1K)	B	42.9/122.3
R2555	7030004980	S.RES ERJ2GEJ 101 X (100)	B	51.4/119.3
R2556	7030005040	S.RES ERJ2GEJ 472 X (4.7K)	B	44.5/125.2
R2559	7030010040	S.RES ERJ2GEJ-JPW	B	49.5/124.6
R2560	7030008410	S.RES ERJ2GEJ 392 X (3.9K)	B	49.5/125.5
R2561	7030008410	S.RES ERJ2GEJ 392 X (3.9K)	B	52.9/124.7
R2562	7030008410	S.RES ERJ2GEJ 392 X (3.9K)	B	53.9/122.8
R2564	7030005090	S.RES ERJ2GEJ 104 X (100K)	B	46.1/126.1
R2565	7030009280	S.RES ERJ2GEJ 391 X	B	41.8/116.9
R2566	7030005050	S.RES ERJ2GEJ 103 X (10K)	B	59/126.8
R2567	7030005050	S.RES ERJ2GEJ 103 X (10K)	B	60.6/126.8
R2568	7030005040	S.RES ERJ2GEJ 472 X (4.7K)	B	47.8/124.7
R2569	7030005040	S.RES ERJ2GEJ 472 X (4.7K)	B	46.1/125.2
R2601	7030010040	S.RES ERJ2GEJ-JPW	B	66.7/123.4
R2602	7030005000	S.RES ERJ2GEJ 471 X (470)	B	57.2/122.6
R2603	7030005240	S.RES ERJ2GEJ 473 X (47K)	B	63.4/121.7
R2604	7030008400	S.RES ERJ2GEJ 182 X (1.8K)	B	66.7/124.3
R2605	7030005120	S.RES ERJ2GEJ 102 X (1K)	B	65.5/126
R2607	7030010040	S.RES ERJ2GEJ-JPW	T	40.5/132.1
R2608	7030009320	S.RES ERJ2GEJ 4R7 X (4.7)	B	83.9/132.7
R2611	7030005050	S.RES ERJ2GEJ 103 X (10K)	B	33.9/124.8
R2612	7030005090	S.RES ERJ2GEJ 104 X (100K)	B	38.4/125.4
R2613	7030005080	S.RES ERJ2GEJ 823 X (82K)	B	38.4/123.6
R2614	7030005120	S.RES ERJ2GEJ 102 X (1K)	B	34.7/126.6
R2617	7030005040	S.RES ERJ2GEJ 472 X (4.7K)	T	63.3/111.1
R2618	7030007340	S.RES ERJ2GEJ 153 X (15K)	T	69.3/112.6
R2619	7030005060	S.RES ERJ2GEJ 333 X (33K)	T	63.3/112.1
R2620	7030005120	S.RES ERJ2GEJ 102 X (1K)	T	78.1/100.3
R2621	7030005120	S.RES ERJ2GEJ 102 X (1K)	T	78.1/99.4
R2623	7030005240	S.RES ERJ2GEJ 473 X (47K)	T	9.8/112.9
R2624	7030004970	S.RES ERJ2GEJ 470 X (47)	B	86.8/122
R2628	7030005240	S.RES ERJ2GEJ 473 X (47K)	B	61.8/121.7

[MAIN UNIT]

REF NO.	PARTS NO.	DESCRIPTION	M.	H/V LOCATION
C5	4030017460	S.CER ECJ0EB1E102K	B	47.5/30.7
C6	4030018960	S.CER C3216 JB 1C 106MT-N	T	66.3/12
C7	4030017330	S.CER ECJ0EF1C104Z	T	73.1/12.2
C8	4030017330	S.CER ECJ0EF1C104Z	T	77.2/9.1
C9	4030017330	S.CER ECJ0EF1C104Z	T	73.1/14
C10	4030017330	S.CER ECJ0EF1C104Z	T	74.8/14.9
C11	4030017330	S.CER ECJ0EF1C104Z	T	73/17.6
C12	4030017330	S.CER ECJ0EF1C104Z	T	76.4/16.7
C13	4030017330	S.CER ECJ0EF1C104Z	T	72.6/16.7
C14	4030017460	S.CER ECJ0EB1E102K	T	67.7/16.5
C15	4030017460	S.CER ECJ0EB1E102K	T	63.7/14.7
C16	4030017460	S.CER ECJ0EB1E102K	T	63.7/15.6
C17	4030017460	S.CER ECJ0EB1E102K	T	62.3/18.8
C18	4030017620	S.CER ECJ0EC1H100C	T	60.7/18.9
C21	4030017730	S.CER ECJ0EB1E471K	T	64.5/13.8
C25	4030017580	S.CER ECJ0EC1H060C	T	55.2/17.8
C26	4030017660	S.CER ECJ0EC1H330J	T	55.2/18.7
C27	4030017780	S.CER ECJ0EB1E472K	T	51.6/20.5
C28	4030017530	S.CER ECJ0EC1H0R5B	T	53.8/17.1
C29	4030017590	S.CER ECJ0EC1H070C	T	51.7/19.6
C30	4030017730	S.CER ECJ0EB1E471K	T	45.8/17.5
C31	4030017530	S.CER ECJ0EC1H0R5B	T	53.8/16.2
C32	4030017660	S.CER ECJ0EC1H330J	T	52.1/17.4
C33	4030017580	S.CER ECJ0EC1H060C	T	52.2/16.5
C34	4030017380	S.CER ECJ0EC1H050B	T	56/15
C35	4030017380	S.CER ECJ0EC1H050B	T	55.9/12.4
C36	4030017730	S.CER ECJ0EB1E471K	T	51/15.6
C37	4030017780	S.CER ECJ0EB1E472K	T	70.4/11.3
C38	4030017780	S.CER ECJ0EB1E472K	T	45.8/18.4
C40	4030017730	S.CER ECJ0EB1E471K	T	73.1/13.1
C41	4030017730	S.CER ECJ0EB1E471K	T	66.9/19.6
C42	4030017730	S.CER ECJ0EB1E471K	T	70.4/12.2
C43	4030017420	S.CER ECJ0EC1H470J	T	45.8/16.6
C44	4030017420	S.CER ECJ0EC1H470J	T	48/11.7
C50	4030017640	S.CER ECJ0EC1H150J	B	80.4/13.6
C51	4030017640	S.CER ECJ0EC1H150J	B	79.9/11.8
C52	4030017430	S.CER ECJ0EC1H101J	B	79.9/12.7
C53	4030016930	S.CER ECJ0EB1A104K	B	79.6/22
C54	4030016930	S.CER ECJ0EB1A104K	T	79.8/12.9
C55	4030016930	S.CER ECJ0EB1A104K	T	78.1/17.9
C56	4030018860	S.CER ECJ0EB0J105K	B	65.5/22.7
C58	4030017710	S.CER ECJ0EC1H181J	T	72.2/19.4
C59	4030017710	S.CER ECJ0EC1H181J	T	65.4/23.7
C101	4030017330	S.CER ECJ0EF1C104Z	T	10.3/15.5
C102	4030017330	S.CER ECJ0EF1C104Z	T	13.2/16.9
C103	4030017330	S.CER ECJ0EF1C104Z	T	13.2/17.8
C104	4030017330	S.CER ECJ0EF1C104Z	T	3.3/29.9
C105	4030017330	S.CER ECJ0EF1C104Z	T	13.2/19.6
C106	4030017850	S.CER C2012 CH 1H 272J-T	T	23.7/10.9
C107	4030017330	S.CER ECJ0EF1C104Z	T	19.2/12.9
C108	4030017330	S.CER ECJ0EF1C104Z	T	36.5/16.6
C109	4030017330	S.CER ECJ0EF1C104Z	T	25.2/14
C110	4030017800	S.CER C1608 CH 1H 561J-T	T	27.8/7.7
C111	4030018590	S.CER C1608 CH 1H 122J-T	T	29.1/5
C112	4030017330	S.CER ECJ0EF1C104Z	T	23.8/5.3
C114	4030018600	S.CER C1608 CH 1H 152J-T	T	25.1/15
C115	4030008490	S.CER C2012 JB 1H 682K-T	T	24.8/16.7
C116	4030017850	S.CER C2012 CH 1H 272J-T	T	24.8/18.4
C117	4030017330	S.CER ECJ0EF1C104Z	T	19.8/7
C118	4030017330	S.CER ECJ0EF1C104Z	T	38.2/17.5
C119	4030017780	S.CER ECJ0EB1E472K	T	7.8/22.2
C120	4030017330	S.CER ECJ0EF1C104Z	T	7.8/21.3
C121	4030017330	S.CER ECJ0EF1C104Z	T	5.7/12.9
C122	4030017330	S.CER ECJ0EF1C104Z	T	13.2/18.7
C123	4030017330	S.CER ECJ0EF1C104Z	T	15.4/14.3
C124	4030017330	S.CER ECJ0EF1C104Z	T	16.3/15.3
C125	4030017460	S.CER ECJ0EB1E102K	T	40/21.7
C126	4030017460	S.CER ECJ0EB1E102K	T	37/22.3
C127	4030017460	S.CER ECJ0EB1E102K	B	19.2/23
C208	4030017330	S.CER ECJ0EF1C104Z	T	19.7/31.2
C209	4030017680	S.CER ECJ0EC1H820J	T	18.5/41.4
C210	4030017610	S.CER ECJ0EC1H090C	T	18.5/40.5
C211	4030017700	S.CER ECJ0EC1H151J	T	18.5/42.3
C212	4030017650	S.CER ECJ0EC1H270J	T	23.2/39.2
C213	4030017510	S.CER ECJ0EC1H680J	T	21.8/43.4
C214	4030018820	S.CER ECJ0EB1H561K	T	31.7/54.4
C215	4030017440	S.CER ECJ0EC1H221J	T	37/54.6
C226	4030017330	S.CER ECJ0EF1C104Z	T	24.1/43.4
C227	4030017330	S.CER ECJ0EF1C104Z	T	19.7/30.3
C228	4030017430	S.CER ECJ0EC1H201J	T	28.1/39.2
C229	4030017440	S.CER ECJ0EC1H112J	T	29.7/39.2
C237	4030017500	S.CER ECJ0EC1H560J	T	28.1/38.2
C238	4030017330	S.CER ECJ0EF1C104Z	T	21.9/30.9
C239	4030017330	S.CER ECJ0EF1C104Z	B	24.7/41.4
C240	4030017400	S.CER ECJ0EC1H220J	B	28.1/43.6
C241	4030017580	S.CER ECJ0EC1H060C		

[MAIN UNIT]

REF NO.	PARTS NO.	DESCRIPTION	M.	H/V LOCATION
C255	4030018580	S.CER C1608 CH 1H 821J-T	T	32.6/55.9
C256	4030010760	S.CER C1608 CH 1H 331J-T	T	38.1/52.1
C257	4030018610	S.CER C1608 CH 1H 182J-T	T	34.4/53.4
C258	4030017870	S.CER C1608 CH 1H 681J-T	T	40.7/52.2
C259	4030018590	S.CER C1608 CH 1H 122J-T	T	37.1/53.4
C260	4030017870	S.CER C1608 CH 1H 681J-T	T	40.7/47.9
C261	4030017780	S.CER ECJ0EB1E472K	B	37.9/56.2
C262	4030017780	S.CER ECJ0EB1E472K	B	37.9/53.8
C263	4030017330	S.CER ECJ0EF1C104Z	B	24.5/50.2
C264	4030017330	S.CER ECJ0EF1C104Z	B	23.9/47.1
C265	4030011280	S.CER C1608 CH 1H 271J-T	B	36.4/46
C266	4030017700	S.CER ECJ0EC1H151J	B	31/44.1
C267	4030018590	S.CER C1608 CH 1H 122J-T	B	36.4/49.6
C268	4030018580	S.CER C1608 CH 1H 821J-T	B	31.7/42.9
C269	4030017710	S.CER ECJ0EC1H181J	B	36.5/47.1
C270	4030017430	S.CER ECJ0EC1H101J	B	32.6/44.1
C271	4030011330	S.CER C1608 CH 1H 391J-T	B	36.4/48.3
C272	4030011280	S.CER C1608 CH 1H 271J-T	B	36.3/43.8
C273	4030011330	S.CER C1608 CH 1H 391J-T	B	38.8/47.3
C274	4030017730	S.CER ECJ0EB1E471K	B	34.2/43.7
C275	4030017780	S.CER ECJ0EB1E472K	B	42.9/49.6
C276	4030017780	S.CER ECJ0EB1E472K	B	39.2/46.2
C278	4030017330	S.CER ECJ0EF1C104Z	T	30.9/31.8
C279	4030017330	S.CER ECJ0EF1C104Z	T	31/43.8
C281	4030017330	S.CER ECJ0EF1C104Z	T	33/31.7
C282	4030017580	S.CER ECJ0EC1H060C	B	31.5/39.2
C283	4030017330	S.CER ECJ0EF1C104Z	B	35.8/35.8
C284	4030017780	S.CER ECJ0EB1E472K	B	42.6/43.3
C285	4030017380	S.CER ECJ0EC1H050B	B	33.1/39.5
C286	4030017510	S.CER ECJ0EC1H680J	B	34.7/39.5
C287	4030017690	S.CER ECJ0EC1H121J	B	36.5/37.8
C288	4030017680	S.CER ECJ0EC1H820J	B	34.2/36.3
C289	4030017420	S.CER ECJ0EC1H470J	B	36.3/36.7
C290	4030018600	S.CER C1608 CH 1H 152J-T	B	38.8/37.6
C291	4030017680	S.CER ECJ0EC1H820J	B	37.9/36.5
C292	4030017330	S.CER ECJ0EF1C104Z	T	30.9/30
C293	4030017780	S.CER ECJ0EB1E472K	B	38.1/34.8
C294	4030017440	S.CER ECJ0EC1H221J	T	38.6/49.6
C295	4030017510	S.CER ECJ0EC1H680J	T	40.4/51.2
C301	4030017330	S.CER ECJ0EF1C104Z	T	47/30.1
C302	4030017330	S.CER ECJ0EF1C104Z	B	56.1/30.7
C303	4030017330	S.CER ECJ0EF1C104Z	T	51.5/33.6
C305	4030017330	S.CER ECJ0EF1C104Z	T	59.9/34.7
C307	4030017330	S.CER ECJ0EF1C104Z	T	59.9/35.6
C308	4030017330	S.CER ECJ0EF1C104Z	T	60.7/36.5
C309	4030017330	S.CER ECJ0EF1C104Z	T	62.8/36.9
C310	4030017330	S.CER ECJ0EF1C104Z	T	60.9/30.1
C311	4030017330	S.CER ECJ0EF1C104Z	T	50.1/32.6
C312	4030017330	S.CER ECJ0EF1C104Z	T	64.5/36.1
C313	4030017380	S.CER ECJ0EC1H050B	T	46.4/23
C314	4030017660	S.CER ECJ0EC1H330J	T	64.8/35.2
C315	4030017340	S.CER ECJ0EC1H010B	T	49.2/22.9
C316	4030017630	S.CER ECJ0EC1H120J	T	66.1/36.1
C317	4030017600	S.CER ECJ0EC1H080C	T	51.4/23.8
C318	4030017680	S.CER ECJ0EC1H820J	T	66.4/35.2
C319	4030017570	S.CER ECJ0EC1H040B	T	53/24.3
C320	4030017570	S.CER ECJ0EC1H040B	T	69.6/37.1
C321	4030017580	S.CER ECJ0EC1H060C	T	58.6/24.4
C322	4030017670	S.CER ECJ0EC1H390J	T	69/32.2
C323	4030017590	S.CER ECJ0EC1H070C	T	60.4/24.2
C324	4030017330	S.CER ECJ0EF1C104Z	T	74.7/38.6
C325	4030017360	S.CER ECJ0EC1H030B	T	62/24.6
C326	4030017780	S.CER ECJ0EB1E472K	T	47.6/47.1
C401	4030017330	S.CER ECJ0EF1C104Z	T	71/30.8
C413	4030017330	S.CER ECJ0EF1C104Z	T	80.6/23.9
C415	4030017330	S.CER ECJ0EF1C104Z	T	71.9/24
C418	4030017330	S.CER ECJ0EF1C104Z	T	67.4/24.8
C422	4030017330	S.CER ECJ0EF1C104Z	T	80/28.6
C423	4030017330	S.CER ECJ0EF1C104Z	T	67.4/23.9
C424	4030017330	S.CER ECJ0EF1C104Z	T	83.2/21
C425	4030017330	S.CER ECJ0EF1C104Z	T	86.9/27.6
C426	4030017330	S.CER ECJ0EF1C104Z	T	78.6/19.8
C427	4030017330	S.CER ECJ0EF1C104Z	T	80/27.7
C429	4030017460	S.CER ECJ0EB1E102K	T	81.8/25.3
C431	4030017330	S.CER ECJ0EF1C104Z	T	88.5/26.7
C432	4030017780	S.CER ECJ0EB1E472K	B	88.5/19.3
C433	4030017780	S.CER ECJ0EB1E472K	T	88.8/20.3
C434	4030017780	S.CER ECJ0EB1E472K	T	86.7/22.9
C511	4030017460	S.CER ECJ0EB1E102K	T	41.8/26.8
C512	4030017780	S.CER ECJ0EB1E472K	T	93.6/33.5
C513	4030017330	S.CER ECJ0EF1C104Z	T	88.4/28.3
C514	4030017330	S.CER ECJ0EF1C104Z	B	88.3/31.7
C515	4030017780	S.CER ECJ0EB1E472K	T	81.7/33.2
C516	4030017580	S.CER ECJ0EC1H060C	T	86.1/38.7
C518	4030017570	S.CER ECJ0EC1H040B	T	86.9/36.5
C525	4030017330	S.CER ECJ0EF1C104Z	T	81.8/32.3
C526	4030016790	S.CER ECJ0EB1C103K	T	77.9/38.2
C527	4030017330	S.CER ECJ0EF1C104Z	T	79.5/37.9
C528	4030017330	S.CER ECJ0EF1C104Z	T	89.7/35.1
C529	4030017670	S.CER ECJ0EC1H390J	T	91.3/33.8
C530	4030017460	S.CER ECJ0EB1E102K	B	87.7/34.1
C602	4030017570	S.CER ECJ0EC1H040B	B	85.7/39.6
C603	4030017780	S.CER ECJ0EB1E472K	T	89.1/40.1
C604	4030017780	S.CER ECJ0EB1E472K	T	94/46.5
C605	4030017620	S.CER ECJ0EC1H100C	T	86/44.2
C606	4030017620	S.CER ECJ0EC1H100C	B	85.7/41.4
C608	4030017550	S.CER ECJ0EC1H1R5B	T	82.7/43.8
C609	4030017580	S.CER ECJ0EC1H060C	B	78.6/46.8
C610	4030017620	S.CER ECJ0EC1H100C	B	80.7/48.1

[MAIN UNIT]

REF NO.	PARTS NO.	DESCRIPTION	M.	H/V LOCATION
C611	4030017780	S.CER ECJ0EB1E472K	B	85.1/37.5
C612	4030017610	S.CER ECJ0EC1H090C	T	79.5/40.5
C613	4030017620	S.CER ECJ0EC1H100C	T	76.5/43.7
C614	4030017780	S.CER ECJ0EB1E472K	T	69.6/38.8
C615	4030017780	S.CER ECJ0EB1E472K	T	64.3/43
C616	4030017780	S.CER ECJ0EB1E472K	T	77.4/39.5
C617	4030017620	S.CER ECJ0EC1H100C	B	85.7/40.5
C618	4030017620	S.CER ECJ0EC1H100C	B	80.7/49
C701	4030017330	S.CER ECJ0EF1C104Z	T	59/50.6
C702	4030017330	S.CER ECJ0EF1C104Z	T	63/45
C703	4510008630	S.ELE 16 CE 47 FE	B	59/44.9
C704	4030017780	S.CER ECJ0EB1E472K	T	58.6/42.9
C705	4030017600	S.CER ECJ0EC1H080C	T	59.6/45.1
C707	4030017330	S.CER ECJ0EF1C104Z	T	64.2/52.9
C708	4030017460	S.CER ECJ0EB1E102K	T	64.5/55
C709	4030017780	S.CER ECJ0EB1E472K	T	60.7/56.6
C710	4030017780	S.CER ECJ0EB1E472K	T	62.3/58.6
C711	4030017460	S.CER ECJ0EB1E102K	T	57.1/50.6
C712	4030017600	S.CER ECJ0EC1H080C	T	52.4/50.2
C714	4030017460	S.CER ECJ0EB1E102K	T	56.2/49.7
C715	4030017780	S.CER ECJ0EB1E472K	T	52.1/53.2
C716	4030017340	S.CER ECJ0EC1H010B	T	55.3/55.1
C717	4030017780	S.CER ECJ0EB1E472K	T	51.2/52.3
C718	4030017780	S.CER ECJ0EB1E472K	T	56.9/55.1
C719	4030017340	S.CER ECJ0EC1H010B	T	61.1/53.9
C720	4030017380	S.CER ECJ0EC1H050B	T	59.3/42
C721	4030017780	S.CER ECJ0EB1E472K	T	51.2/49.6
C801	4030017330	S.CER ECJ0EF1C104Z	T	71.5/64
C803	4030017780	S.CER ECJ0EB1E472K	T	65.3/61.8
C804	4030017330	S.CER ECJ0EF1C104Z	T	91.9/58
C805	4030017460	S.CER ECJ0EB1E102K	T	83.5/55.8
C807	4030017330	S.CER ECJ0EF1C104Z	T	60.6/66.7
C808	4030017870	S.CER C1608 CH 1H 681J-T	T	60.3/65.5
C809	4030018630	S.CER C2012 CH 1H 472J-T	T	57.4/66.8
C810	4030017780	S.CER ECJ0EB1E472K	T	63.9/68.5
C811	4030017700	S.CER ECJ0EC1H151J	T	63.9/69.4
C812	4030017700	S.CER ECJ0EB1E151J	T	60.1/69.4
C813	4030017700	S.CER ECJ0EC1H151J	T	60.1/68.5
C814	4030017330	S.CER ECJ0EF1C104Z	T	88.5/57.1
C815	4030017460	S.CER ECJ0EB1E102K	T	86.6/60.6
C816	4030017400	S.CER ECJ0EC1H220J	T	85.7/59.7
C817	4030017400	S.CER ECJ0EC1H220J	T	84/61.7
C818	4030018590	S.CER C1608 CH 1H 122J-T	T	54.6/65.6
C819	4030017850	S.CER C2012 CH 1H 272J-T	T	51.6/65.8
C901	4030017330	S.CER ECJ0EF1C104Z	T	38.4/71.3
C910	4030017710	S.CER ECJ0EC1H181J	T	39.2/65.6
C911	4030017700	S.CER ECJ0EC1H151J	T	47.9/74.7
C913	4030017330	S.CER ECJ0EF1C104Z	T	38.2/61.1
C914	4030017330	S.CER ECJ0EF1C104Z	T	39.2/63.6
C916	4030017330	S.CER ECJ0EF1C104Z	T	33.9/61.9
C917	4030017780	S.CER ECJ0EB1E472K	T	35.6/63.2
C918	4030017330	S.CER ECJ0EF1C104Z	T	34.2/67.5
C920	4030017460	S.CER ECJ0EB1E102K	T	38.4/74.2
C921	4030017330	S.CER ECJ0EF1C104Z	T	34.2/70.2
C922	4030017330	S.CER ECJ0EF1C104Z	T	29.4/73
C923	4030017330	S.CER ECJ0EF1C104Z	T	29.9/72.1
C924	4030017780	S.CER ECJ0EB1E472K	T	41.2/74.1
C925	4030017700	S.CER ECJ0EC1H151J	B	31.4/73
C1001	4030017780	S.CER ECJ0EB1E472K	T	31.7/71.2
C1009	4030017780	S.CER ECJ0EB1E472K	T	25.8/72
C1016	4030017330	S.CER ECJ0EF1C104Z	T	25.8/73.8
C1018	4030017460	S.CER ECJ0EB1E102K	T	20.3/76
C1019	4030017330	S.CER ECJ0EF1C104Z	T	15.2/75.7
C1020	4030017330	S.CER ECJ0EF1C104Z	T	12.7/75.8
C1021	4030017330	S.CER ECJ0EF1C104Z	T	4.6/78.9
C1022	4510008630	S.ELE 16 CE 47 FE	B	6.1/86
C1023	4510008630	S.ELE 16 CE 47 FE	B	5.7/77.4
C1101	4030017490	S.CER C1608 JB 1A 105K-T	T	2.5/78.9
C1102	4030017330	S.CER ECJ0EF1C104Z	T	4.6/78
C1104	4030017490	S.CER C1608 JB 1A 105K-T	T	2.5/87.8
C1105	4030018960	S.CER C3216 JB 1C 106MT-N	T	2.9/89.7
C1108	4030017330	S.CER ECJ0EF1C104Z	T	2.3/91.3
C1201	4030017330	S.CER ECJ0EF1C104Z	T	26.6/80.6
C1202	4030017330	S.CER ECJ0EF1C104Z	T	28.7/80.5
C1203	4030017330	S.CER ECJ0EF1C104Z	T	18.6/79.2
C1204	4030018960	S.CER C3216 JB 1C 106MT-N	T	9/76.9
C1206	4030017780	S.CER ECJ0EB1E472K	T	14.3/79.4
C1207	4030017780	S.CER ECJ0EB1E472K	T	12.7/78.5
C1208	4030018800	S.CER ECJ0EB1H182K	T	12.9/85
C1209	4030018820	S.CER ECJ0EB1H561K	T	12.9/84.1
C1210	4030017780	S.CER ECJ0EB1E472K	T	11.3/84.1
C1211	4030017490	S.CER C1608 JB 1A 105K-T	T	9.2/84.5
C1212	4030017490	S.CER C1608 JB 1A 105K-T	T	6.7/87.8
C1213	4030017330	S.CER ECJ0EF1C104Z	T	21.8/78.3
C1301	4030017330	S.CER ECJ0EF1C104Z	T	15.2/73.6
C1302	4030017330	S.CER ECJ0EF1C104Z	T	15.1/67.3
C1303	4030018860	S.CER ECJ0EB0J105K	T	11.3/67.3
C1304	4030017330	S.CER ECJ0EF1C104Z	T	14.3/69.2
C1305	4030017330	S.CER ECJ0EF1C104Z	T	1

[MAIN UNIT]

REF NO.	PARTS NO.	DESCRIPTION	M.	H/V LOCATION
C1404	4030017700	S.CER ECJ0EC1H151J	B	41.9/70.5
C1405	4030017780	S.CER ECJ0EB1E472K	B	43.6/71.4
C1406	4030017780	S.CER ECJ0EB1E472K	B	42/72.4
C1407	4030017780	S.CER ECJ0EB1E472K	B	44.6/74.3
C1408	4030017780	S.CER ECJ0EB1E472K	B	40.3/79
C1409	4030017780	S.CER ECJ0EB1E472K	B	34.7/79
C1411	4030018860	S.CER ECJ0EB0J105K	B	27/79.9
C1412	4030016950	S.CER ECJ0EB1A473K	B	27/80.8
C1413	4030017490	S.CER C1608 JB 1A 105K-T	B	20.7/77.4
C1414	4030016950	S.CER ECJ0EB1A473K	B	25/77.8
C1415	4510008640	S.ELE 6 CE 100 FE	B	13.2/81.2
C1416	4030016950	S.CER ECJ0EB1A473K	B	20.2/78.5
C1418	4030017350	S.CER ECJ0EC1H020B	B	23/86.6
C1419	4030018390	S.CER ECJ0EB1A563K	B	23/87.5
C1420	4030017420	S.CER ECJ0EC1H470J	B	17.8/83
C1421	4030018960	S.CER C3216 JB 1C 106MT-N	B	19.8/87.3
C1422	4030017640	S.CER ECJ0EC1H150J	B	17.8/82.1
C1423	4610001970	S.TRI TZC3P200A110R00	T	3.8/72.5
C1491	4030017670	S.CER ECJ0EC1H390J [EUR]	B	88.2/29.3
	4030017670	S.CER ECJ0EC1H390J [FRA]		
	4030017670	S.CER ECJ0EC1H390J [ESP]		
	4030017400	S.CER ECJ0EC1H220J [USA]		
	4030017670	S.CER ECJ0EC1H390J [EXP]		
	4030017670	S.CER ECJ0EC1H390J [ITR]		
	4030017670	S.CER ECJ0EC1H390J [UK]		
	4030017400	S.CER ECJ0EC1H220J [KOR]		
	4030017670	S.CER ECJ0EC1H390J [AUS]		
	4030017670	S.CER ECJ0EC1H390J [CHN]		
C1493	4030017660	S.CER ECJ0EC1H330J	B	86.1/33.7
C1494	4030017670	S.CER ECJ0EC1H390J [EUR]	B	83.6/34
	4030017670	S.CER ECJ0EC1H390J [FRA]		
	4030017670	S.CER ECJ0EC1H390J [ESP]		
	4030017420	S.CER ECJ0EC1H470J [USA]		
	4030017670	S.CER ECJ0EC1H390J [EXP]		
	4030017670	S.CER ECJ0EC1H390J [ITR]		
	4030017670	S.CER ECJ0EC1H390J [UK]		
	4030017420	S.CER ECJ0EC1H470J [KOR]		
	4030017670	S.CER ECJ0EC1H390J [AUS]		
	4030017670	S.CER ECJ0EC1H390J [CHN]		
C1495	4030011280	S.CER C1608 CH 1H 271J-T [EUR]	B	84/32.9
	4030011280	S.CER C1608 CH 1H 271J-T [FRA]		
	4030011280	S.CER C1608 CH 1H 271J-T [ESP]		
	4030010760	S.CER C1608 CH 1H 331J-T [USA]		
	4030011280	S.CER C1608 CH 1H 271J-T [EXP]		
	4030011280	S.CER C1608 CH 1H 271J-T [ITR]		
	4030011280	S.CER C1608 CH 1H 271J-T [UK]		
	4030010760	S.CER C1608 CH 1H 331J-T [KOR]		
	4030011280	S.CER C1608 CH 1H 271J-T [AUS]		
	4030011280	S.CER C1608 CH 1H 271J-T [CHN]		
C1496	4030017660	S.CER ECJ0EC1H330J	B	79.3/35.3
C1498	4030017670	S.CER ECJ0EC1H390J [EUR]	B	79.3/36.2
	4030017670	S.CER ECJ0EC1H390J [FRA]		
	4030017670	S.CER ECJ0EC1H390J [ESP]		
	4030017400	S.CER ECJ0EC1H220J [USA]		
	4030017670	S.CER ECJ0EC1H390J [EXP]		
	4030017670	S.CER ECJ0EC1H390J [ITR]		
	4030017670	S.CER ECJ0EC1H390J [UK]		
	4030017400	S.CER ECJ0EC1H220J [KOR]		
	4030017670	S.CER ECJ0EC1H390J [AUS]		
	4030017670	S.CER ECJ0EC1H390J [CHN]		
C1501	4030017410	S.CER ECJ0EC1H240J	B	79.3/37.1
C1503	4030017330	S.CER ECJ0EF1C104Z	B	78.9/61.9
C1504	4030017510	S.CER ECJ0EB1H680J	B	80.9/36.4
C1506	4030017780	S.CER ECJ0EB1E472K	B	92.1/28.8
C1507	4030017410	S.CER ECJ0EC1H240J	B	82.5/36.4
C1508	4030017780	S.CER ECJ0EB1E472K	B	77.3/38.6
C1509	4030017780	S.CER ECJ0EB1E472K	B	72.4/39.1
C1510	4030017780	S.CER ECJ0EB1E472K	B	72.4/41.2
C1511	4030016790	S.CER ECJ0EB1C103K	B	86.4/56.2
C1512	4030017780	S.CER ECJ0EB1E472K	B	77/41.6
C1513	4030018900	S.CER ECJ0EB0J474K	B	73.6/55.1
C1514	4030017780	S.CER ECJ0EB1E472K	B	73.5/42.1
C1515	4030018960	S.CER C3216 JB 1C 106MT-N	B	68.3/53.7
C1516	4030017330	S.CER ECJ0EF1C104Z	B	77.3/49
C1517	4030017730	S.CER ECJ0EB1E471K	B	73.4/53.9
C1518	4030016790	S.CER ECJ0EB1C103K	B	85.7/51.4
C1519	4030018960	S.CER C3216 JB 1C 106MT-N	B	69.3/47.4
C1520	4510008630	S.ELE 16 CE 47 FE	B	91/45.4
C1521	4030017680	S.CER ECJ0EC1H820J	B	85.9/58
C1522	4030017670	S.CER ECJ0EC1H390J	T	73.2/55.3
C1523	4030017330	S.CER ECJ0EF1C104Z	T	31.2/80.4
C1524	4030017420	S.CER ECJ0EC1H470J [EUR]	B	73.6/60.5
	4030017420	S.CER ECJ0EC1H470J [FRA]		
	4030017420	S.CER ECJ0EC1H470J [ESP]		
	4030017510	S.CER ECJ0EC1H680J [USA]		
	4030017420	S.CER ECJ0EC1H470J [EXP]		
	4030017420	S.CER ECJ0EC1H470J [ITR]		
	4030017420	S.CER ECJ0EC1H470J [UK]		
	4030017510	S.CER ECJ0EC1H680J [KOR]		
	4030017420	S.CER ECJ0EC1H470J [AUS]		
	4030017420	S.CER ECJ0EC1H470J [CHN]		
C1525	4030018900	S.CER ECJ0EB0J474K	B	85.8/59.9
C1526	4030018960	S.CER C3216 JB 1C 106MT-N	B	69.3/51.5
C1531	4030017490	S.CER C1608 JB 1A 105K-T	B	82.8/48.3
C1532	4030017780	S.CER ECJ0EB1E472K	B	81.9/41.3
C1533	4030017780	S.CER ECJ0EB1E472K	B	81.9/39.4
C1534	4030017780	S.CER ECJ0EB1E472K	B	83.5/38.5
C1601	4030017780	S.CER ECJ0EB1E472K	T	6.3/52.2
C1604	4030017780	S.CER ECJ0EB1E472K	T	5.6/50.8

[MAIN UNIT]

REF NO.	PARTS NO.	DESCRIPTION	M.	H/V LOCATION
C1605	4030017330	S.CER ECJ0EF1C104Z	T	8.8/48.7
C1607	4030017780	S.CER ECJ0EB1E472K	T	14.7/46
C1609	4030017490	S.CER C1608 JB 1A 105K-T	T	14.1/33.6
C1610	4030017330	S.CER ECJ0EF1C104Z	T	12.1/44.7
C1611	4030017330	S.CER ECJ0EF1C104Z	T	14.6/41.1
C1613	4030017330	S.CER ECJ0EF1C104Z	T	18.9/47.1
C1614	4030017730	S.CER ECJ0EB1E471K	T	15/36.1
C1615	4030017420	S.CER ECJ0EC1H470J	T	10.4/46.9
C1616	4550007260	S.TAN F931C475MAABMA	T	9.6/50.5
C1618	4030017430	S.CER ECJ0EC1H101J	T	12.7/26.3
C1701	4030017490	S.CER C1608 JB 1A 105K-T	B	55.1/50.4
C1702	4030017490	S.CER C1608 JB 1A 105K-T	B	55/69.6
C1801	4030017330	S.CER ECJ0EF1C104Z	B	18.4/105
C1802	4510008630	S.ELE 16 CE 47 FE	B	14.4/101.2
C1803	4030018960	S.CER C3216 JB 1C 106MT-N	B	22.3/112.1
C1804	4030017330	S.CER ECJ0EF1C104Z	B	22.8/110.6
C1901	4030017330	S.CER ECJ0EF1C104Z	T	36.2/80.4
C1902	4030017330	S.CER ECJ0EF1C104Z	T	33.7/80.4
C1903	4030017330	S.CER ECJ0EF1C104Z	B	23.3/18.8
C1904	4030017330	S.CER ECJ0EF1C104Z	B	32.5/89.8
C1905	4030017330	S.CER ECJ0EF1C104Z	B	25.9/33.8
C1906	4030017330	S.CER ECJ0EF1C104Z	B	25.9/32.9
C1907	4030017330	S.CER ECJ0EF1C104Z	T	41.6/80.3
C1908	4030017330	S.CER ECJ0EF1C104Z	T	38.4/80.7
C1909	4030017330	S.CER ECJ0EF1C104Z	B	21.6/13.9
C1910	4030017460	S.CER ECJ0EB1E102K	B	45.4/25.4
C1916	4030018960	S.CER C3216 JB 1C 106MT-N	B	14.7/50.5
C1917	4030018960	S.CER C3216 JB 1C 106MT-N	B	5.3/52.7
C1951	4030018960	S.CER C3216 JB 1C 106MT-N	B	48.1/103.1
C1952	4030018960	S.CER C3216 JB 1C 106MT-N	B	48.1/98.9
C1953	4030018960	S.CER C3216 JB 1C 106MT-N	B	48.1/96.8
C1954	4030018960	S.CER C3216 JB 1C 106MT-N	B	48.6/105.2
C1955	4030018960	S.CER C3216 JB 1C 106MT-N	B	48.1/101
C1956	4030018960	S.CER C3216 JB 1C 106MT-N	B	60.9/118.7
C1957	4030017330	S.CER ECJ0EF1C104Z	B	63.8/116.7
C1958	4030018910	S.CER C1608 JB 0J 475K-T	B	20.9/125.7
C1959	4550007090	S.TAN TEESVA 1A 226M8R	B	11.6/120.2
C1960	4030010210	S.CER C3216 JB 1C 105M-T	B	47.3/109.7
C1961	4030017730	S.CER ECJ0EB1E471K	B	44/110
C1962	4030017440	S.CER ECJ0EC1H221J	B	44.6/108.4
C1963	4030017500	S.CER ECJ0EC1H560J	B	35.3/105.1
C1964	4030017330	S.CER ECJ0EF1C104Z	B	44.3/111.3
C1965	4030018960	S.CER C3216 JB 1C 106MT-N	B	7.4/108
C1966	4030017330	S.CER ECJ0EF1C104Z	B	10.1/103
C1968	4030018960	S.CER C3216 JB 1C 106MT-N	B	31.7/103.6
C1969	4030018970	S.CER C3225 JB 1C 226MT-N	B	30.8/100.9
C1970	4030018970	S.CER C3225 JB 1C 226MT-N	B	30.8/97.9
C1971	4030017330	S.CER ECJ0EF1C104Z	B	45.9/111.3
C1972	4030017330	S.CER ECJ0EF1C104Z	B	47.6/106.7
C1973	4030017330	S.CER ECJ0EF1C104Z	B	32.1/105.1
C2001	4030017780	S.CER ECJ0EB1E472K	T	33.2/10.3
C2002	4030017330	S.CER ECJ0EF1C104Z	B	71.7/14.6
C2003	4030017780	S.CER ECJ0EB1E472K	B	58.8/15.8
C2004	4030017780	S.CER ECJ0EB1E472K	B	83/5.9
C2005	4030017780	S.CER ECJ0EB1E472K	B	69/16.4
C2006	4030017330	S.CER ECJ0EF1C104Z	B	83/6.8
C2007	4030017780	S.CER ECJ0EB1E472K	B	84.6/5.9
C2008	4030017330	S.CER ECJ0EF1C104Z	B	56.7/10.1
C2009	4030017330	S.CER ECJ0EF1C104Z	B	75.4/18.6
C2010	4030017780	S.CER ECJ0EB1E472K	B	75.6/6.6
C2011	4030017330	S.CER ECJ0EF1C104Z	B	75/7.7
C2012	4030017780	S.CER ECJ0EB1E472K	B	63.1/15.5
C2013	4030017330	S.CER ECJ0EF1C104Z	B	88.9/2
C2014	4030017780	S.CER ECJ0EB1E472K	B	32.5/11.8
C2015	4030017780	S.CER ECJ0EB1E472K	B	32.5/12.7
C2016	4030017780	S.CER ECJ0EB1E472K	B	19/131.2
C2017	4030017330	S.CER ECJ0EF1C104Z	T	86.4/10.2
C2018	4030017780	S.CER ECJ0EB1E472K	B	42.7/17.7
C2019	4030017780	S.CER ECJ0EB1E472K	T	24.7/126.7
C2020	4030017330	S.CER ECJ0EF1C104Z	B	84.1/23.1
C2021	4030017780	S.CER ECJ0EB1E472K	B	32.5/16
C2022	4030017780	S.CER ECJ0EB1E472K	B	30.3/130.2
C2024	4030017780	S.CER ECJ0EB1E472K	B	28.7/128.2
C2025	4030017780	S.CER ECJ0EB1E472K	B	45/12.5
C2026	4030018960	S.CER C3216 JB 1C 106MT-N	B	10.1/23.4
C2027	4030018960	S.CER C3216 JB 1C 106MT-N	B	10.1/14.6
C2028	4030017330	S.CER ECJ0EF1C104Z	B	51.7/12.7
C2029	4030017330	S.CER ECJ0EF1C104Z	B	58.1/9.4
C2030	4030017330	S.CER ECJ0EF1C104Z	B	55.8/15.8
C2032	4030017780	S.CER ECJ0EB1E472K	B	27.4/12.9
C2033	4030017330	S.CER ECJ0EF1C104Z	B	71.1/21.9
C2034	4030017780	S.CER ECJ0EB1E472K	B	64.8/5.6
C2035	4030017780	S.CER ECJ0EB1E472K	B	25.6/130.2
C2036	4030017330	S.CER ECJ0EF1C104Z	B	88.2/8
C2037	4030017330	S.CER ECJ0EF1C104Z	B	76.4/16.5
C2038	4030017780	S.CER ECJ0EB1E472K	B	14.5/126.4
C2039	4030017780	S.CER ECJ0EB1E472K	B	80.2/6.7
C2040	4030017780	S.CER ECJ0EB1E472K	B	64.6/17.7
C2041	4030017330	S.CER ECJ0EF1C104Z	B	75.2/10.5
C2042	4030017330	S.CER ECJ0EF1C104Z	B	62.7/18.1
C2043	4030017780	S.CER ECJ0EB1E472K	B	55.4/8.8
C2044	4030017780	S.CER ECJ0EB1E472K	B	62.7/19.5
C2045	4030017780	S.CER ECJ0EB1E472K	B	64.3/21.8
C2046	4030017780	S.CER ECJ0EB1E472K	B	63.6/14.6

[MAIN UNIT]

REF NO.	PARTS NO.	DESCRIPTION	M.	H/V LOCATION
C2052	4030017780	S.CER ECJ0EB1E472K	T	21.6/108
C2053	4030017780	S.CER ECJ0EB1E472K	T	49.8/107.5
C2054	4030018960	S.CER C3216 JB 1C 106MT-N	B	55.3/83.4
C2055	4030018960	S.CER C3216 JB 1C 106MT-N	B	28.1/88.5
C2058	4030018960	S.CER C3216 JB 1C 106MT-N	B	16.4/95.5
C2062	4550007710	S.TAN TEESVBD 1A 476M8R	B	26.6/13
C2063	4030017730	S.CER ECJ0EB1E471K	B	46/13.7
C2064	4030018960	S.CER C3216 JB 1C 106MT-N	B	61.1/23
C2065	4030016930	S.CER ECJ0EB1A104K	B	73.3/1.2
C2066	4030016930	S.CER ECJ0EB1A104K	B	75.1/1.2
C2067	4030017430	S.CER ECJ0EC1H101J	B	56.9/19.9
C2068	4030017460	S.CER ECJ0EB1E102K	B	59.1/26.1
C2069	4030017730	S.CER ECJ0EB1E471K	B	46.6/12.1
C2101	4030017330	S.CER ECJ0EF1C104Z	T	28.3/13.8
C2102	4030017330	S.CER ECJ0EF1C104Z	T	44.7/110.9
C2103	4030018960	S.CER C3216 JB 1C 106MT-N	T	28.8/112.2
C2104	4030017330	S.CER ECJ0EF1C104Z	T	56.1/123.5
C2105	4030018960	S.CER C3216 JB 1C 106MT-N	T	54.7/125
C2156	4030017330	S.CER ECJ0EF1C104Z	T	36.2/122.1
C2157	4030017330	S.CER ECJ0EF1C104Z	B	34.4/91
C2158	4030017330	S.CER ECJ0EF1C104Z	B	27.4/93.7
C2159	4030017330	S.CER ECJ0EF1C104Z	T	22.4/94.4
C2160	4030017330	S.CER ECJ0EF1C104Z	B	38.2/88.8
C2161	4030018960	S.CER C3216 JB 1C 106MT-N	T	36.8/123.6
C2162	4030018960	S.CER C3216 JB 1C 106MT-N	B	37.7/90.4
C2163	4030017780	S.CER ECJ0EB1E472K	T	4.6/116.5
C2164	4030018960	S.CER C3216 JB 1C 106MT-N	T	6.5/114.9
C2166	4030012610	S.CER C2012 JB 1C 474K-T	T	5.2/106.8
C2167	4030018960	S.CER C3216 JB 1C 106MT-N	T	4.9/109.9
C2168	4030012610	S.CER C2012 JB 1C 474K-T	T	16.5/116.8
C2169	4030016930	S.CER ECJ0EB1A104K	T	14/124.2
C2201	4030017780	S.CER ECJ0EB1E472K	T	24.7/125.8
C2203	4030018520	S.CER C1608 JB 0J 225M-T	T	16/118.4
C2204	4030017330	S.CER ECJ0EF1C104Z	T	11.1/119.7
C2205	4030018960	S.CER C3216 JB 1C 106MT-N	T	12.4/117.1
C2206	4030017780	S.CER ECJ0EB1E472K	T	21.7/115.6
C2208	4030017730	S.CER ECJ0EB1E471K	T	19/116.9
C2211	4030018960	S.CER C3216 JB 1C 106MT-N	T	22.4/119.9
C2212	4030018960	S.CER C3216 JB 1C 106MT-N	T	23.2/124.3
C2213	4550007140	S.TAN TEESVD 1C 107M12R	T	37.6/138.5
C2214	4030018910	S.CER C1608 JB 0J 475K-T	T	20.9/122.6
C2231	4030017330	S.CER ECJ0EF1C104Z	T	38.2/105.6
C2232	4030018960	S.CER C3216 JB 1C 106MT-N	T	38.1/104
C2233	4030017780	S.CER ECJ0EB1E472K	T	4.7/123.2
C2234	4550007310	S.TAN F930J227MNBMA	T	70.1/130.6
C2235	4030018960	S.CER C3216 JB 1C 106MT-N	T	40.9/108.8
C2236	4030018960	S.CER C3216 JB 1C 106MT-N	T	39.8/111.1
C2237	4030017460	S.CER ECJ0EB1E102K	T	60.6/123.3
C2254	4030017330	S.CER ECJ0EF1C104Z	T	7.6/92.5
C2255	4030017330	S.CER ECJ0EF1C104Z	B	2.4/98.1
C2256	4030017330	S.CER ECJ0EF1C104Z	B	2.6/95.6
C2257	4030017330	S.CER ECJ0EF1C104Z	T	9.9/87.9
C2260	4030017330	S.CER ECJ0EF1C104Z	T	18.5/103.6
C2261	4030017330	S.CER ECJ0EF1C104Z	T	6.7/104.4
C2262	4030017330	S.CER ECJ0EF1C104Z	T	58.5/100.3
C2264	4030017330	S.CER ECJ0EF1C104Z	T	61.8/88.9
C2266	4030017330	S.CER ECJ0EF1C104Z	T	72/85.2
C2268	4030017330	S.CER ECJ0EF1C104Z	T	68.5/89.4
C2269	4030017330	S.CER ECJ0EF1C104Z	B	78.4/92.4
C2270	4030017780	S.CER ECJ0EB1E472K	T	61.8/89.8
C2272	4030017330	S.CER ECJ0EF1C104Z	T	56.2/92.2
C2274	4030017330	S.CER ECJ0EF1C104Z	T	55.8/95
C2275	4030017330	S.CER ECJ0EF1C104Z	B	68.1/99.3
C2276	4030017330	S.CER ECJ0EF1C104Z	B	64.2/100.6
C2277	4030017330	S.CER ECJ0EF1C104Z	T	63.6/103.4
C2278	4030017330	S.CER ECJ0EF1C104Z	T	63.6/107.9
C2279	4030017330	S.CER ECJ0EF1C104Z	T	62.7/108.8
C2280	4030017420	S.CER ECJ0EC1H470J	T	51.8/37.9
C2281	4030017330	S.CER ECJ0EF1C104Z	T	68.5/90.3
C2282	4030017330	S.CER ECJ0EF1C104Z	B	80.4/93
C2283	4030017330	S.CER ECJ0EF1C104Z	B	81.6/92.1
C2285	4030017330	S.CER ECJ0EF1C104Z	T	50.8/99
C2286	4030017330	S.CER ECJ0EF1C104Z	T	14.1/88.8
C2301	4030018910	S.CER C1608 JB 0J 475K-T	T	30.8/106.9
C2302	4030018910	S.CER C1608 JB 0J 475K-T	T	27.8/109.4
C2303	4550007310	S.TAN F930J227MNBMA	T	84.4/110.3
C2311	4030017330	S.CER ECJ0EF1C104Z	B	68.1/110.2
C2312	4030018910	S.CER C1608 JB 0J 475K-T	B	67.3/104.9
C2401	4030017330	S.CER ECJ0EF1C104Z	B	90.8/103.8
C2402	4030017330	S.CER ECJ0EF1C104Z	B	81.2/100.7
C2403	4030017780	S.CER ECJ0EB1E472K	B	77.2/28.8
C2405	4030017330	S.CER ECJ0EF1C104Z	T	74.2/79.3
C2406	4030017460	S.CER ECJ0EB1E102K	B	88.5/99.7
C2407	4030017330	S.CER ECJ0EF1C104Z	T	74.1/78.2
C2408	4030017330	S.CER ECJ0EF1C104Z	B	84.9/96.1
C2409	4030017330	S.CER ECJ0EF1C104Z	T	75.6/77.6
C2410	4030017330	S.CER ECJ0EF1C104Z	B	88.5/85.8
C2411	4030017330	S.CER ECJ0EF1C104Z	B	81.1/96.4
C2412	4510008630	S.ELE 16 CE 47 FE	B	62.1/30.4
C2413	4030017330	S.CER ECJ0EF1C104Z	B	88.5/93.7
C2414	4030017780	S.CER ECJ0EB1E472K	T	84/95.6
C2415	4030017780	S.CER ECJ0EB1E472K	B	88.3/28
C2417	4030017330	S.CER ECJ0EF1C104Z	B	88.3/27.1
C2418	4030017330	S.CER ECJ0EF1C104Z	B	82.6/94
C2419	4030017330	S.CER ECJ0EF1C104Z	B	88.5/86.7
C2422	4030017330	S.CER ECJ0EF1C104Z	T	84.8/87.3
C2423	4030017420	S.CER ECJ0EC1H470J	B	62.1/141.2
C2424	4510008630	S.ELE 16 CE 47 FE	B	69.2/31.3
C2426	4030017330	S.CER ECJ0EF1C104Z	B	68.8/82.1

[MAIN UNIT]

REF NO.	PARTS NO.	DESCRIPTION	M.	H/V LOCATION
C2427	4030012600	S.CER C2012 JB 1A 105M-T	T	85.1/91.4
C2501	4030017330	S.CER ECJ0EF1C104Z	B	8/94.2
C2502	4030018960	S.CER C3216 JB 1C 106MT-N	B	11.5/95.2
C2503	4030016970	S.CER ECJ0EB1C223K	B	14.9/89.3
C2505	4030016940	S.CER ECJ0EB1A393K	B	17.4/91.4
C2506	4030017780	S.CER ECJ0EB1E472K	B	18.2/93.8
C2507	4030017490	S.CER C1608 JB 1A 105K-T	B	12.7/89.2
C2551	4030017330	S.CER ECJ0EF1C104Z	B	42.9/124.1
C2552	4030018960	S.CER C3216 JB 1C 106MT-N	B	47.8/118.8
C2553	4030016970	S.CER ECJ0EB1C223K	B	51.3/124.7
C2554	4030018390	S.CER ECJ0EB1A563K	B	53.9/121.9
C2555	4030017760	S.CER ECJ0EB1H222K	B	53.9/121
C2556	4030017770	S.CER ECJ0EB1E332K	B	52.8/123.8
C2557	4030017330	S.CER ECJ0EF1C104Z	B	41.7/120.8
C2558	4030018960	S.CER C3216 JB 1C 106MT-N	B	42.9/118.4
C2561	4030018960	S.CER C3216 JB 1C 106MT-N	B	56.5/124.3
C2562	4030018960	S.CER C3216 JB 1C 106MT-N	B	53.4/126.4
C2563	4550007110	S.TAN SY6-1A107M-RC	B	75.3/122.8
C2564	4030018080	S.CER ECJ0EB1H182K	B	47.8/125.6
C2565	4030017430	S.CER ECJ0EC1H101J	B	44.6/122.6
C2566	4030018090	S.CER ECJ0EB1C822K	B	46.2/124.3
C2601	4030017330	S.CER ECJ0EF1C104Z	B	59.7/125.1
C2603	4030010210	S.CER C3216 JB 1C 105M-T	B	87.5/126
C2604	4030016970	S.CER ECJ0EB1C223K	B	89.1/128.6
C2605	4030017330	S.CER ECJ0EF1C104Z	B	83.9/133.7
C2606	4510009250	S.ELE EEEFK1C471P	T	69.2/137.4
C2607	4510008650	S.ELE EEEFK1C221P	T	58.5/138.3
C2608	4030017330	S.CER ECJ0EF1C104Z	B	87.5/128.6
C2610	4510009250	S.ELE EEEFK1C471P	T	6/265.3
C2612	4030017330	S.CER ECJ0EF1C104Z	B	33.9/123.9
C2613	4510009250	S.ELE EEEFK1C471P	T	31.7/131.5
C2616	4030017780	S.CER ECJ0EB1E472K	B	31.6/134.3
C2617	4030017780	S.CER ECJ0EB1E472K	T	33.5/126
C2618	4030017430	S.CER ECJ0EC1H101J	B	31.6/133.4
C2619	4030017780	S.CER ECJ0EB1E472K	T	67.7/112.6
C2620	4510008630	S.ELE 16 CE 47 FE	B	82.9/119.1
C2621	4510008500	S.ELE EEE1CA101WP	T	49.2/138.3
C2622	4510008500	S.ELE EEE1CA101WP	T	60.1/130.4
C2624	4030017330	S.CER ECJ0EF1C104Z	B	38.4/124.5
CP1601	6910009670	S.CHE HK3-S-T	T	11.7/54.7
J1	6510007020	CON TMP-J01X-V6		
J101	6510007020	CON TMP-J01X-V6		
J401	6510007020	CON TMP-J01X-V6		
J801	6510007020	CON TMP-J01X-V6		
J2002	6510019971	S.CON 52808-1071	T	39/12.6
J2003	6510024861	S.CON 5406721-2	T	18.7/137.8
J2004	6510023511	S.CON 28FLT-SM2-TB(LF)(SN) 2	T	82.4/4.9
J2005	6510023511	S.CON 28FLT-SM2-TB(LF)(SN) 2	T	66/4.9
J2231	6510018961	S.CON B2B-PH-SM4-TB(LF)(SN)	T	51.6/129.5
J2251	6510022881	S.CON AXK5S30347YG	T	12.3/96.6
J2252	6510024820	S.CON AXK5S60340P 2	T	72.4/101.1
J2401	6510025770	S.CON 03-935H0-72BKA	B	57.7/136.6
J2402	6510025770	S.CON 03-935H0-72BKA	B	47/136.6
J2403	6510019371	S.CON B3B-ZR-SM4-TF(LF)(SN)	T	94.8/1.8
J2405	6510024880	S.CON 52689-3087	T	90.3/93.8
J2406	6510024880	S.CON 52689-3087	T	90.3/70.9
J2407	6510025770	S.CON 03-935H0-72BKA	B	68.4/136.6
J2601	6510014961	S.CON B2B-ZR-SM4-TF(LF)(SN)	T	42.6/128.8
J2602	6510025770	S.CON 03-935H0-72BKA	B	36.3/136.6
W1	9029701008	WIR 72/98/020/X98/X98		
W601	9029701008	WIR 72/98/020/X98/X98		
EP104	6910012350	S.BEA MMZ1608Y 102BT	T	61.2/28.2
EP511	6910012350	S.BEA MMZ1608Y 102BT	T	44.1/26.5
EP1951	6910014730	S.BEA MPZ2012S331A-T	B	61.3/116.7
EP1952	6910014730	S.BEA MPZ2012S331A-T	B	26.8/113.3
EP1953	6910014730	S.BEA MPZ2012S331A-T	B	9.9/104.5
EP1954	6910014730	S.BEA MPZ2012S331A-T	B	50.3/107.3
EP2001	6910012350	S.BEA MMZ1608Y 102BT	B	74.2/5.3
EP2002	6910012350	S.BEA MMZ1608Y 102BT	B	34.7/12.6
EP2003	6910012350	S.BEA MMZ1608Y 102BT	B	33.5/13.8
EP2004	6910012350	S.BEA MMZ1608Y 102BT	B	39.5/15.9
EP2006	6910014730	S.BEA MPZ2012S331A-T	B	42.2/13.3
EP2007	6910012350	S.BEA MMZ1608Y 102BT	B	45.2/11
EP2008	6910012350	S.BEA MMZ1608Y 102BT	B	45.1/14.8
EP2231	6910012350	S.BEA MMZ1608Y 102BT	T	59.8/125.7
EP2251	6910012350	S.BEA MMZ1608Y 102BT	T	4.5/95.5
EP2252	6910012350	S.BEA MMZ1608Y 102BT	T	7.5/95.8
EP2253	6910012350	S.BEA MMZ1608Y 102BT	T	66.1/109.3
EP2254	6910012350	S.BEA MMZ1608Y 102BT	T	65.7/108.1
EP2255	6910012350	S.BEA MMZ1608Y 102BT	T	17.8/101.5
EP2256	6910012350	S.BEA MMZ1608Y 102BT	T	65.1/106
EP2257	6910012350	S.BEA MMZ1608Y 102BT	T	65.1/104.8
EP2258	6910012350	S.BEA MMZ1608Y 102BT	B	77.9/93.4
EP2259	6910012350	S.BEA MMZ1608Y 102BT	B	68.1/102

[MAIN UNIT]

REF NO.	PARTS NO.	DESCRIPTION	M.	H/V LOCATION
EP2271	6910012350	S.BEA MMZ1608Y 102BT	T	74.6/91.1
EP2402	6910012350	S.BEA MMZ1608Y 102BT	B	51.1/129.6
EP2403	6910012350	S.BEA MMZ1608Y 102BT	B	48.4/129.6
EP2404	6910012350	S.BEA MMZ1608Y 102BT	B	68.5/129.3
EP2405	6910012350	S.BEA MMZ1608Y 102BT	B	62.1/134.9
EP2408	6910012350	S.BEA MMZ1608Y 102BT	B	91.3/102.7
EP2409	6910012350	S.BEA MMZ1608Y 102BT	T	85.3/101.2
EP2410	6910012350	S.BEA MMZ1608Y 102BT	T	84.7/98.3
EP2411	6910012350	S.BEA MMZ1608Y 102BT	T	85.2/79.2
EP2412	6910012350	S.BEA MMZ1608Y 102BT	T	82.5/78.4
EP2413	6910012350	S.BEA MMZ1608Y 102BT	B	72.4/129.3
EP2414	6910012350	S.BEA MMZ1608Y 102BT	B	89.3/91
EP2415	6910012350	S.BEA MMZ1608Y 102BT	T	84.9/100
EP2416	6910012350	S.BEA MMZ1608Y 102BT	T	80/77.6
EP2417	6910012350	S.BEA MMZ1608Y 102BT	B	87.2/78.8
EP2602	6910014730	S.BEA MPZ2012S331A-T	T	35.9/125.6
EP2604	6910014730	S.BEA MPZ2012S331A-T	B	31.6/135.7
EP2605	6910014730	S.BEA MPZ2012S331A-T	T	42.9/135.4
EP2606	6910014730	S.BEA MPZ2012S331A-T	T	41.3/133.7
MP201	8510017210	PLA 2427 B-SHIELD PLATE Y801	B	23.1/59.8
W101	8970024640	CBL 1.5D175MM C24/C31		
W401	8970024650	CBL 1.5D 200MM (SX2427 A5-6G1)		

[PA UNIT]

REF NO.	PARTS NO.	DESCRIPTION	M.	H/V LOCATION
IC471	1110005630	S.IC UPC3215TB-E3-A	B	67.6/96.4
IC701	1180002010	S.REG BA08FP-E2	B	126.3/41.9
IC960	1110002700	S.IC NJM2904M-TE1-#FMZB	B	41/132.1
IC981	1130012720	S.IC CD74HC4094PWR	T	26.2/5.9
Q101	1560001091	S.FET 2SK2854(T2LICOM,F)	T	149.2/28.5
Q102	1560001241	S.FET RD01MUS1-T113	T	146/40.1
Q301	1560001391	FET RD70HHF1-101		
Q302	1560001391	FET RD70HHF1-101		
Q401	1560001401	FET RD60HUF1-101		
Q402	1590000680	S.TRA DTC114EUA T106	B	87.7/132.8
Q403	1590000680	S.TRA DTC114EUA T106	B	90/130.3
Q451	1580000691	S.FET 3SK291(TE85R,F)	B	76.7/108.3
Q452	1590003940	S.TRA RN1105(TE85L,F)	B	67.5/115.8
Q453	1590003940	S.TRA RN1105(TE85L,F)	B	75.1/119.8
Q501	1560001591	FET RD70HVF1C-121		
Q502	1590000680	S.TRA DTC114EUA T106	T	87.7/107.5
Q503	1590000680	S.TRA DTC114EUA T106	T	87.7/110
Q551	1580000691	S.FET 3SK291(TE85R,F)	T	68.4/108.9
Q552	1590003940	S.TRA RN1105(TE85L,F)	T	63/110.1
Q700	1590003940	S.TRA RN1105(TE85L,F)	B	126.4/25
Q741	1590003940	S.TRA RN1105(TE85L,F)	B	79.4/9
Q742	1520000460	S.TRA 2SB1132 T100 R	B	83.6/8.2
Q980	1590003940	S.TRA RN1105(TE85L,F)	T	51.3/84.6
Q981	1590003940	S.TRA RN1105(TE85L,F)	T	51.5/13.8
Q982	1590003940	S.TRA RN1105(TE85L,F)	T	53.8/97.3
Q983	1590003940	S.TRA RN1105(TE85L,F)	T	51.2/56.9
Q984	1590003940	S.TRA RN1105(TE85L,F)	T	51.6/97.2
Q985	1590003940	S.TRA RN1105(TE85L,F)	T	51.3/27.9
Q986	1590003940	S.TRA RN1105(TE85L,F)	T	51.3/71.4
Q987	1590003940	S.TRA RN1105(TE85L,F)	T	52.5/41.6
Q988	1590003930	S.TRA UMD22N TR	T	58.2/90.2
D101	1750000301	S.DIO 1SS302(TE85R,F)	T	152.4/22.7
D102	1750000301	S.DIO 1SS302(TE85R,F)	T	152.4/19.8
D151	1750000581	S.DIO 1SV307(TPH3,F)	T	59.5/56.4
D152	1790001250	S.DIO MA2S111-(TX)	T	56.3/58.5
D301	1160000060	S.DIO DAN202U T106	T	105.1/80.8
D302	1160000060	S.DIO DAN202U T106	T	74.9/87.3
D401	1790001240	S.DIO MA2S728-(TX)	B	128/133.6
D402	1790001240	S.DIO MA2S728-(TX)	B	127.5/139.5
D403	1790001240	S.DIO MA2S728-(TX)	B	123.4/140.5
D404	1790001240	S.DIO MA2S728-(TX)	B	125.6/132.8
D406	1710001061	DIO L407CDB		
D407	1710001061	DIO L407CDB		
D408	1750000511	S.DIO UX9401F-STD/TR	B	97.7/136.4
D409	1750000511	S.DIO UX9401F-STD/TR	B	103.5/133
D410	1750000511	S.DIO UX9401F-STD/TR	B	104.7/130
D411	1790001250	S.DIO MA2S111-(TX)	B	94.2/129.2
D412	1160000070	S.DIO DAN202K T146	B	91.6/127
D451	1750000581	S.DIO 1SV307(TPH3,F)	B	85.5/116.3
D452	1750000581	S.DIO 1SV307(TPH3,F)	B	82.4/116
D453	1720000701	S.VAR 1SV305(TPL3,F)	T	75.5/117.3
D454	1720000701	S.VAR 1SV305(TPL3,F)	T	77.8/116.6
D455	1720000701	S.VAR 1SV305(TPL3,F)	B	75.6/99.1
D456	1720000701	S.VAR 1SV305(TPL3,F)	B	67.3/104.1
D461	1750000581	S.DIO 1SV307(TPH3,F)	B	65/93.5
D462	1750000581	S.DIO 1SV307(TPH3,F)	T	65.6/94.7
D501	1790000970	S.DIO MA729(TX)	B	113.7/123.4
D502	1790000970	S.DIO MA729(TX)	B	116.3/122.8
D503	1790000970	S.DIO MA729(TX)	B	114.5/129.4
D504	1790000970	S.DIO MA729(TX)	B	111/129.4
D506	1710001061	DIO L407CDB		
D507	1750000511	S.DIO UX9401F-STD/TR	B	92.1/117.4
D508	1750000511	S.DIO UX9401F-STD/TR	T	86.9/114.4
D509	1750000511	S.DIO UX9401F-STD/TR	T	81.9/120.3
D510	1710001061	DIO L407CDB		
D511	1750000581	S.DIO 1SV307(TPH3,F)	B	95.3/112.2
D551	1750000581	S.DIO 1SV307(TPH3,F)	T	74/116.7
D552	1750000581	S.DIO 1SV307(TPH3,F)	T	72.2/116.7
D553	1750000610	S.VAR MA2SV0500L 0	T	67.2/118.5
D554	1750000610	S.VAR MA2SV0500L 0	T	69.6/117.8
D555	1750000581	S.DIO 1SV307(TPH3,F)	T	66.9/116.7
D556	1720000590	S.VAR MA357(TX) 0	T	71.6/113.3
D557	1750000581	S.DIO 1SV307(TPH3,F)	T	68.1/104.9
D558	1720000590	S.VAR MA357(TX) 0	T	72.2/104.3
D559	1750000610	S.VAR MA2SV0500L 0	T	68.9/102.7
D560	1750000610	S.VAR MA2SV0500L 0	T	71.7/101.3
D701	1790000700	DIO DSA3A1		
D702	1790000700	DIO DSA3A1		
D703	1160000070	S.DIO DAN202K T146	B	126.5/21.5
D704	1790001240	S.DIO MA2S728-(TX)	B	87.9/113.9
D705	1160000070	S.DIO DAN202K T146	B	137.5/14.2
D706	1790001240	S.DIO MA2S728-(TX)	B	86/113
D801	1750000301	S.DIO 1SS302(TE85R,F)	B	42.7/41.8
D820	1750000301	S.DIO 1SS302(TE85R,F)	B	54.3/94.5
D840	1750000301	S.DIO 1SS302(TE85R,F)	B	43.3/99.8
D860	1750000301	S.DIO 1SS302(TE85R,F)	B	43/86
D880	1750000301	S.DIO 1SS302(TE85R,F)	B	43.3/71.6
D900	1750000301	S.DIO 1SS302(TE85R,F)	B	43.7/56.9
D920	1750000301	S.DIO 1SS302(TE85R,F)	B	42.9/28
D940	1750000301	S.DIO 1SS302(TE85R,F)	B	41.1/14.2
D961	1790000491	S.DIO HSM88ASTR-E	B	28.1/130.2
D962	1790000491	S.DIO HSM88ASTR-E	B	28.1/133.7
D964	1750000511	S.DIO UX9401F-STD/TR	B	40.1/43.9
D965	1750000511	S.DIO UX9401F-STD/TR	B	42.8/48

M.=Mounted side (T: Mounted on the Top side, B: Mounted on the Bottom side)
S.=Surface mount

[PA UNIT]

REF NO.	PARTS NO.	DESCRIPTION	M.	H/V LOCATION
L101	6200005051	S.COI NLV25T-330J	T	151.3/33.6
L102	6200008570	S.COI LQW2BHN6N8D03L	T	152.3/37.3
L103	6180000990	COI LAL 04NA 101K		
L104	6180000990	COI LAL 04NA 101K		
L105	6200003950	S.COI HF50ACC 322513-T	B	135.7/34.1
L107	6200002631	S.COI NLV25T-R10J	T	141/47.9
L108	6200003031	S.COI NLV32T-F47J	B	138/41.7
L151	6200003941	S.COI NLV25T-5R6J	B	64.1/41
L152	6200005521	S.COI NLV25T-470J	B	64.8/38
L201	6140004580	S.COI LR-515	T	150.4/52.5
L203	6200010040	S.COI AS100340-10N	T	113.8/79.5
L204	6200010040	S.COI AS100340-10N	T	123.5/69.7
L301	6140003410	COI LR-383		
L302	2040000490	COI EXC-ELDR25C		
L303	6140003590	COI LR-400 (TR10X5X5 6H3)		
L304	6140004570	COI LR-507		
L305	6140004560	COI LR-506		
L404	6200010060	S.COI AS080647-56N	T	141/108.9
L407	6200010170	S.COI AS080447-33N	T	146.6/110.7
L408	2040000490	COI EXC-ELDR25C		
L409	2040000490	COI EXC-ELDR25C		
L410	6200010040	S.COI AS100340-10N	T	126.5/137.8
L411	6200010420	S.COI FHW1210HC 1R0JGT <JJE>	T	118.3/136.7
L412	6200010160	S.COI AS080440-22N	T	104.4/134.4
L413	6200010150	S.COI AS080340-15N	T	88.2/139.5
L414	6200010150	S.COI AS080340-15N	T	81/133.5
L415	6200012960	S.COI 0.45-1.0-4TR 12.1N <COMO>	T	99.2/134
L416	6200013000	S.COI 0.25-1.9-13TL 135N <COMO>	T	93.8/132.1
L417	6200007790	S.COI LQW2BHN15J03L	B	98.3/131.1
L441	6200010040	S.COI AS100340-10N	T	133.4/137.8
L451	6200005621	S.COI ELJRE 4N7ZFA	B	81.5/120.1
L452	6200012660	S.COI 0.30-1.0-4TR 9.1N <COMO>	T	76.7/114.9
L453	6200007230	S.COI LQW2BHN15N03L	B	74/104
L454	6200007230	S.COI LQW2BHN15N03L	B	69.9/102.3
L501	6200010780	S.COI C2520C-1R0G-A	T	117.1/86.6
L502	6200010060	S.COI AS080647-56N	T	118.1/125
L504	6200010780	S.COI C2520C-1R0G-A	T	105.7/123.4
L505	6200010070	S.COI AS080747-68N	T	90.2/118.5
L506	6200010170	S.COI AS080447-33N	T	91.9/124.3
L507	6200012910	S.COI 0.35-1.6-8TL 45.5N <COMO>	T	84.7/118
L508	6200010050	S.COI AS080547-47N	T	81.8/127.7
L509	6200010780	S.COI C2520C-1R0G-A	T	93.2/113.1
L510	6200010050	S.COI AS080547-47N	T	75.5/127.5
L531	6110003980	COI LA-604		
L541	6200010070	S.COI AS080747-68N	T	128.5/129.8
L551	6200007700	S.COI LQW2BHN22N03L	T	76.1/120.8
L552	6200007720	S.COI LQW2BHN33N03L	T	70.8/121.2
L553	6200008090	S.COI LQW2BHN68N03L	T	65.1/121.6
L554	6200003640	S.COI MLF1608E 100K-T	T	64.9/114.8
L555	6200003711	S.COI NLV25T-2R7J	T	65.2/105.4
L556	6200003640	S.COI MLF1608E 100K-T	B	64.9/109.6
L557	6200007760	S.COI LQW2BHN82N03L	T	66.8/100.5
L558	6200007710	S.COI LQW2BHN27N03L	T	69.9/98.3
L560	6200002611	S.COI NLV25T-F47J	T	62.9/97.3
L601	6200010040	S.COI AS100340-10N	T	69.2/127.5
L602	6200010160	S.COI AS080440-22N	T	65.7/132.8
L603	6200010150	S.COI AS080340-15N	T	60.8/133.5
L705	6200003550	S.COI MLF1608A 4R7K-T	B	68.2/10.3
L706	6200011300	S.COI EXCML16A270U	T	91/6.9
L707	6200011300	S.COI EXCML16A270U	T	91/5.6
L801	6200011410	S.COI C2520C-82NG-A	T	55.8/55.5
L802	6200010650	S.COI C2520C-R12G-A (0.12U)	T	58.5/52.1
L803	6200007420	S.COI ELJFC 101K-F	B	50.4/39.8
L820	6200006430	S.COI ELJFC 180K-F	B	52.8/97.3
L821	6140002020	COI LR-229 (T50-10)		
L822	6140003540	COI LR-396		
L823	6200006430	S.COI ELJFC 180K-F	B	2.7/106.8
L840	6200007420	S.COI ELJFC 101K-F	B	49.2/98.5
L841	6140001820	COI LR-218 (T50-10)		
L842	6140001800	COI LR-216 (T50-2)		
L843	6140001800	COI LR-216 (T50-2)		
L844	6200007420	S.COI ELJFC 101K-F	B	2.6/90.7
L860	6200004440	S.COI ELJFC 4R7M-F	B	50.3/83.8
L861	6110003550	COI LA-547 (LA-214A)		
L862	6110003570	COI LA-550		
L863	6110003540	COI LA-548 (LA-215A)		
L864	6200004440	S.COI ELJFC 4R7M-F	B	2.8/74.5
L880	6200007420	S.COI ELJFC 101K-F	B	50.3/69.1
L881	6140002570	COI LR-294 (T50-2)		
L882	6140002580	COI LR-295 (T50-2)		
L883	6200007420	S.COI ELJFC 101K-F	B	2.6/58.4
L900	6200008600	S.COI ELJFC 560K-F	B	50/54.6
L901	6140002560	COI LR-293 (T50-10)		
L902	6140002560	COI LR-293 (T50-10)		
L903	6140002560	COI LR-293 (T50-10)		
L904	6200008600	S.COI ELJFC 560K-F	B	2.6/42.3
L920	6200007420	S.COI ELJFC 101K-F	B	50.4/25.4
L921	6140001780	COI LR-214 (T50-2)		
L922	6140001780	COI LR-214 (T50-2)		
L923	6200007420	S.COI ELJFC 101K-F	B	2.6/26.1
L940	6200007390	S.COI ELJFC 120K-F	B	47.3/9.9
L941	6140003450	COI LR-387 (T50-10)		
L942	6140003460	COI LR-388 (T50-10)		
L943	6200007420	S.COI ELJFC 101K-F	B	41.1/11.1
L944	6200007390	S.COI ELJFC 120K-F	B	9/10.5
L960	6200007420	S.COI ELJFC 101K-F	B	45.3/130.6
L961	6140003490	COI LR-391 (TR10X5X5 3A6)		
L980	6200007420	S.COI ELJFC 101K-F	B	30.7/8
L981	6200007420	S.COI ELJFC 101K-F	T	51.7/9

[PA UNIT]

REF NO.	PARTS NO.	DESCRIPTION	M.	H/V LOCATION
L982	6200007420	S.COI ELJFC 101K-F	T	48.3/2.3
R101	7030003370	S.RES ERJ3GEYJ 271 V (270)	B	150.9/21
R102	7030003230	S.RES ERJ3GEYJ 180 V (18)	B	150.9/22.5
R103	7030003370	S.RES ERJ3GEYJ 271 V (270)	B	151.9/25.2
R104	7030003300	S.RES ERJ3GEYJ 680 V (68)	B	150.8/27.7
R105	7030003420	S.RES ERJ3GEYJ 681 V (680)	T	152.7/29.8
R106	7030003480	S.RES ERJ3GEYJ 222 V (2.2K)	B	147.8/29.7
R107	7030003530	S.RES ERJ3GEYJ 562 V (5.6K)	B	147.8/28.3
R108	7030003400	S.RES ERJ3GEYJ 471 V (470)	T	151.4/31.7
R109	7030008190	S.RES ERJ12YJ330U (33)	B	145.5/32.7
R110	7030000230	S.RES MCR10EZJH 56 (560)	T	149.4/39.8
R111	7030003410	S.RES ERJ3GEYJ 561 V (560)	B	143.8/42.1
R112	7030003510	S.RES ERJ3GEYJ 392 V (3.9K)	B	146.1/37.5
R113	7030003540	S.RES ERJ3GEYJ 682 V (6.8K)	B	146.1/35.7
R116	7030000340	S.RES MCR10EZJH 470 (471)	B	141.3/40.8
R117	7030003860	S.RES ERJ3GE JPW V	T	146.7/47.7
R151	7030003380	S.RES ERJ3GEYJ 331 V (330)	B	61.6/37.8
R152	7030003440	S.RES ERJ3GEYJ 102 V (1K)	B	61.7/60.1
R153	7030003520	S.RES ERJ3GEYJ 472 V (4.7K)	T	59.2/57.9
R201	7030003320	S.RES ERJ3GEYJ 101 V (100)	B	123/49.9
R202	7030003520	S.RES ERJ3GEYJ 472 V (4.7K)	B	136/49.8
R204	7030003440	S.RES ERJ3GEYJ 102 V (1K)	B	138/52.8
R205	7030010420	S.RES ERJ1TYJ 560U (56)	B	145/51.5
R301	7030009300	S.RES ERJ1WYOR00U	B	92.2/84.4
R302	7030010520	S.RES ERJ1TYJ 101U (100)	T	89.4/86.1
R303	7030009300	S.RES ERJ1WYOR00U	B	85.4/84.4
R304	7030003320	S.RES ERJ3GEYJ 101 V (100)	T	107.1/79.8
R305	7030010410	S.RES ERJ1TYJ 220U (22)	T	100.2/84.1
R306	7030003320	S.RES ERJ3GEYJ 101 V (100)	B	71.2/83.3
R307	7030010410	S.RES ERJ1TYJ 220U (22)	T	77.5/84.1
R308	7030003480	S.RES ERJ3GEYJ 222 V (2.2K)	B	99/84.9
R309	7030003480	S.RES ERJ3GEYJ 222 V (2.2K)	B	78.7/84.9
R310	7030007630	S.RES MCR100JZHJ 0.68 (R68)	B	100.1/82.2
R311	7030007630	S.RES MCR100JZHJ 0.68 (R68)	B	78.3/82.1
R312	7030011250	S.RES ERJ1TYJ 390U (39)	T	100.9/77.7
R313	7030010540	S.RES ERJ1TYJ 330U (33)	T	97.2/77.7
R314	7030010540	S.RES ERJ1TYJ 330U (33)	T	81.6/77.7
R315	7030011250	S.RES ERJ1TYJ 390U (39)	T	77.9/77.7
R317	7030010950	S.RES ERJ1TYJ 100U (10)	B	104/20.6
R318	7030010950	S.RES ERJ1TYJ 100U (10)	B	99.6/20.6
R319	7030010660	S.RES ERJ1TYJ 6R8U (6.8)	B	89.4/54.5
R402	7030003320	S.RES ERJ3GEYJ 101 V (100)	B	151.7/73.1
R403	7030003520	S.RES ERJ3GEYJ 472 V (4.7K)	T	151.8/71.2
R404	7030000260	S.RES MCR10EZJH 100 (101)	T	149.4/76
R405	7030003540	S.RES ERJ3GEYJ 682 V (6.8K)	B	126.7/137.5
R406	7030003860	S.RES ERJ3GE JPW V	B	128.4/136.1
R407	7030003440	S.RES ERJ3GEYJ 102 V (1K)	B	129.7/133.6
R408	7030003860	S.RES ERJ3GE JPW V	B	124.1/137.6
R409	7030003440	S.RES ERJ3GEYJ 102 V (1K)	B	127/130.4
R410	7030003440	S.RES ERJ3GEYJ 102 V (1K)	B	131.6/133
R411	7030003540	S.RES ERJ3GEYJ 682 V (6.8K)	B	125.1/135.5
R412	7030003500	S.RES ERJ3GEYJ 332 V (3.3K)	B	131.1/129.7
R413	7030007160	S.RES ERJ12YJ3R3U (3.3)	B	123.5/125.1
R415	7030008350	S.RES ERJ12YJ390U	B	86.7/136.4
R416	7030000140	S.RES MCR10EZJH 10 (100)	B	93.8/130.7
R417	7030000140	S.RES MCR10EZJH 10 (100)	B	95.5/132.5
R418	7030000010	S.RES MCR10EZJH JPW (000)	B	99.3/133.9
R451	7030003470	S.RES ERJ3GEYJ 182 V (1.8K)	B	81.5/121.7
R452	7030004040	S.RES ERJ3GEYJ 4R7 V (4.7)	B	85.5/119.3
R453	7030003260	S.RES ERJ3GEYJ 330 V (33)	B	81.6/118.4
R454	7030003860	S.RES ERJ3GE JPW V	B	77.3/116
R455	7030003640	S.RES ERJ3GEYJ 473 V (47K)	B	73.2/117.5
R456	7030003700	S.RES ERJ3GEYJ 154 V (150K)	B	72/114.4
R457	7030003750	S.RES ERJ3GEYJ 394 V (390K)	B	71.2/111.9
R458	7030003710	S.RES ERJ3GEYJ 184 V (180K)	B	73.8/112.4
R459	7030003740	S.RES ERJ3GEYJ 334 V (330K)	B	69.6/111.3
R460	7030003740	S.RES ERJ3GEYJ 334 V (330K)	B	76.6/112.1
R461	7030003270	S.RES ERJ3GEYJ 390 V (39)	B	77.7/103.3
R462	7030003680	S.RES ERJ3GEYJ 104 V (100K)	B	72.9/99.6
R463	7030003520	S.RES ERJ3GEYJ 472 V (4.7K)	B	74.4/102.4
R464	7030003210	S.RES ERJ3GEYJ 120 V (12)	B	74.1/105.7
R465	7030003680	S.RES ERJ3GEYJ 104 V (100K)	B	66.5/101.7
R466	7030003860	S.RES ERJ3GE JPW V	B	62.1/100.2
R467	7030003640	S.RES ERJ3GEYJ 473 V (47K)	B	75.1/117.2
R468	7030008240	S.RES ERJ12YOR00U	B	89.1/121.9
R470	7030003320	S.RES ERJ3GEYJ 101 V (100)	B	67.7/98.8
R471	7030003270	S.RES ERJ3GEYJ 390 V (39)	B	69.6/98.3
R472	7030003340	S.RES ERJ3GEYJ 151 V (150)	B	69.6/99.5
R473	7030003340	S.RES ERJ3GEYJ 151 V (150)	B	69.6/100.7
R474	7030003340	S.RES ERJ3GEYJ 151 V (150)	B	63.5/96.9
R475	7030003340	S.RES ERJ3GEYJ 151 V (150)	B	64.9/96.9
R476	7030003270	S.RES ERJ3GEYJ 390 V (39)	B	64.8/95.1
R477	7030003360	S.RES ERJ3GEYJ 221 V (220)	B	61.8/97.6
R502	7030003320	S.RES ERJ3GEYJ 101 V (100)	T	112.1/87.9
R503	7030003520	S.RES ERJ3GEYJ 472 V (4.7K)	T	112.6/86
R504	7030000260	S.RES MCR10EZJH 100 (101)	T	114.2/86.2
R505	7030003540	S.RES ERJ3GEYJ 682 V (6.8K)	B	119.9/124.8
R507	7030003440	S.RES ERJ3GEYJ 102 V (1K)	B	110.2

[PA UNIT]

REF NO.	PARTS NO.	DESCRIPTION	M.	H/V LOCATION
R519	7030000010	S.RES MCR10EZHZ JPW (000)	B	111.1/119.1
R551	7030003470	S.RES ERJ3GEYJ 182 V (1.8K)	T	78.2/117.8
R552	7030004040	S.RES ERJ3GEYJ 4R7 V (4.7)	T	76.7/119.1
R553	7030003260	S.RES ERJ3GEYJ 330 V (33)	T	73/118.9
R554	7030003680	S.RES ERJ3GEYJ 104 V (100K)	T	66.8/120.4
R555	7030003440	S.RES ERJ3GEYJ 102 V (1K)	T	68.1/114.7
R556	7030003680	S.RES ERJ3GEYJ 104 V (100K)	T	69.9/116.6
R557	7030003740	S.RES ERJ3GEYJ 334 V (330K)	T	65.7/112.9
R558	7030003710	S.RES ERJ3GEYJ 184 V (180K)	T	70.5/111.2
R559	7030003720	S.RES ERJ3GEYJ 224 V (220K)	T	65.7/111.7
R560	7030003720	S.RES ERJ3GEYJ 224 V (220K)	T	65.6/110.5
R561	7030003740	S.RES ERJ3GEYJ 334 V (330K)	T	68.3/112.4
R562	7030003270	S.RES ERJ3GEYJ 390 V (39)	T	70.1/106.6
R563	7030003420	S.RES ERJ3GEYJ 681 V (680)	T	65.4/107.3
R564	7030003210	S.RES ERJ3GEYJ 120 V (12)	T	63.5/103
R565	7030003440	S.RES ERJ3GEYJ 102 V (1K)	B	65.6/106.3
R567	7030003680	S.RES ERJ3GEYJ 104 V (100K)	T	70.1/104
R568	7030003680	S.RES ERJ3GEYJ 104 V (100K)	T	69.7/100.7
R570	7030003380	S.RES ERJ3GEYJ 331 V (330)	T	62.8/100.38
R575	7030003520	S.RES ERJ3GEYJ 472 V (4.7K)	T	68.4/100.7
R576	7030003540	S.RES ERJ3GEYJ 682 V (6.8K)	T	71.8/100
R577	7030003520	S.RES ERJ3GEYJ 472 V (4.7K)	T	68/120.4
R578	7030003540	S.RES ERJ3GEYJ 682 V (6.8K)	T	69.9/119
R701	7030003500	S.RES ERJ3GEYJ 332 V (3.3K)	B	82.2/16.9
R702	7030003500	S.RES ERJ3GEYJ 332 V (3.3K)	B	83/14.5
R703	7030003500	S.RES ERJ3GEYJ 332 V (3.3K)	B	80.6/16.9
R704	7030003500	S.RES ERJ3GEYJ 332 V (3.3K)	B	79.7/14.5
R705	7030009300	S.RES ERJ1WYOR00U	B	134.6/23.8
R721	7030011240	S.RES LRF3W-LF-01-R020F	B	83/22.3
R722	7030011240	S.RES LRF3W-LF-01-R020F	B	83/29.6
R723	7030004040	S.RES ERJ3GEYJ 4R7 V (4.7)	B	140.5/14.7
R733	7030009591	S.RES ERA3YED 472V (4.7K)	B	138.6/10.4
R734	7510001470	S.THE NTCG20 4AG 473JT	T	111.9/58.2
R735	7030009591	S.RES ERA3YED 472V (4.7K)	B	140.2/12.5
R736	7510001470	S.THE NTCG20 4AG 473JT	T	153.3/77.1
R742	7030003640	S.RES ERJ3GEYJ 473 V (47K)	B	83.4/11.5
R743	7030003440	S.RES ERJ3GEYJ 102 V (1K)	B	80.2/10.9
R744	7030003860	S.RES ERJ3GE JPW V	T	67.8/9.6
R749	7030003860	S.RES ERJ3GE JPW V	B	65/5.2
R750	7030003860	S.RES ERJ3GE JPW V	B	66.6/5.2
R773	7030003860	S.RES ERJ3GE JPW V	T	103.4/9.5
R960	7030003860	S.RES ERJ3GE JPW V	B	43.2/125.7
R961	7030003380	S.RES ERJ3GEYJ 331 V (330)	B	42/138.3
R962	7030003440	S.RES ERJ3GEYJ 102 V (1K)	B	37.4/137.8
R963	7030003440	S.RES ERJ3GEYJ 102 V (1K)	B	40.3/126.3
R964	7030003860	S.RES ERJ3GE JPW V	B	24.8/131.2
R965	7030003640	S.RES ERJ3GEYJ 473 V (47K)	B	32.6/130.5
R966	7030008190	S.RES ERJ12YJ330U (33)	B	11.1/129.6
R967	7030003640	S.RES ERJ3GEYJ 473 V (47K)	B	34.2/130.5
R968	7030003860	S.RES ERJ3GE JPW V	B	24.8/132.8
R969	7030003600	S.RES ERJ3GEYJ 223 V (22K)	B	32.6/133.6
R970	7030003680	S.RES ERJ3GEYJ 104 V (100K)	B	34.2/133.6
R971	7540000130	ABS 2P-50A-301		
R972	7030003620	S.RES ERJ3GEYJ 333 V (33K)	B	17.4/140.1
R973	7030003620	S.RES ERJ3GEYJ 333 V (33K)	B	18.9/138.5
R974	7030003620	S.RES ERJ3GEYJ 333 V (33K)	B	19.4/136.6
R994	7030003560	S.RES ERJ3GEYJ 103 V (10K)	B	22.4/2.6
R995	7030003560	S.RES ERJ3GEYJ 103 V (10K)	B	22.4/6.8
R996	7030003560	S.RES ERJ3GEYJ 103 V (10K)	B	21.6/5.4
R997	7030003560	S.RES ERJ3GEYJ 103 V (10K)	B	21.6/8.2
R998	7030003320	S.RES ERJ3GEYJ 101 V (100)	T	54.1/4.4
R999	7030003320	S.RES ERJ3GEYJ 101 V (100)	T	54.5/3.1
R1000	7030003320	S.RES ERJ3GEYJ 101 V (100)	T	51.2/3.5
R1001	7030003320	S.RES ERJ3GEYJ 101 V (100)	T	49.3/4.9
R1002	7030000280	S.RES MCR10EZHZ 150 (151)	T	48/9.7
R1003	7030000290	S.RES MCR10EZHZ 180 (181)	T	47.5/7.9
C101	4030011600	S.CER C1608 JB 1E 104K-T	T	151.9/25.1
C102	4030011600	S.CER C1608 JB 1E 104K-T	B	150.8/29.3
C103	4030011340	S.CER C1608 CH 1H 471J-T	T	152.7/27.2
C104	4030011600	S.CER C1608 JB 1E 104K-T	T	147.8/32.2
C105	4510004591	ELE 16 ME 470 HC		
C106	4030011600	S.CER C1608 JB 1E 104K-T	B	142.7/29.2
C107	4030011600	S.CER C1608 JB 1E 104K-T	T	151.6/39.7
C108	4030011600	S.CER C1608 JB 1E 104K-T	T	149.2/36.5
C109	4030007130	S.CER C1608 CH 1H 101J-T	B	146.6/42.1
C112	4030011600	S.CER C1608 JB 1E 104K-T	B	139.2/35.1
C113	4030011600	S.CER C1608 JB 1E 104K-T	T	144.6/44.4
C114	4030011600	S.CER C1608 JB 1E 104K-T	B	134.1/37
C116	4030007060	S.CER C1608 CH 1H 270J-T	T	144.6/45.8
C118	4030007130	S.CER C1608 CH 1H 101J-T	T	143.5/48.5
C119	4030007130	S.CER C1608 CH 1H 101J-T	T	144/50.4
C120	4030007020	S.CER C1608 CH 1H 120J-T	T	143.5/47.2
C122	4510008500	S.ELE EEE1CA101WP	T	121.5/11.2
C151	4030011600	S.CER C1608 JB 1E 104K-T	T	59.2/54.8
C152	4030006880	S.CER C1608 JB 1H 472K-T	B	61.6/36.2
C153	4030011600	S.CER C1608 JB 1E 104K-T	B	63.1/56
C154	4030006860	S.CER C1608 JB 1H 102K-T	B	63.1/54.7
C201	4030006860	S.CER C1608 JB 1H 102K-T	T	145.6/53
C202	4030006860	S.CER C1608 JB 1H 102K-T	T	143/53
C204	4030011600	S.CER C1608 JB 1E 104K-T	B	139.3/48.4
C205	4030006860	S.CER C1608 JB 1H 102K-T	B	123.3/48.6
C206	4030017810	S.CER C1608 CH 1H 102J-T	B	133.5/50.6
C207	4030017810	S.CER C1608 CH 1H 102J-T	B	139.3/49.7
C208	4030011600	S.CER C1608 JB 1E 104K-T	B	132/50.6
C209	4030007170	S.CER C1608 CH 1H 221J-T	B	139.3/51
C214	4030018940	S.CER GRM31A7U2J221JW31D	T	116.3/76.1
C215	4030018930	S.CER GRM31A7U2J221JW31D	T	122.2/73.9

[PA UNIT]

REF NO.	PARTS NO.	DESCRIPTION	M.	H/V LOCATION
C217	4030011600	S.CER C1608 JB 1E 104K-T	T	144.3/53
C218	4030018930	S.CER GRM31A7U2J221JW31D	T	101/88.5
C219	4030018930	S.CER GRM31A7U2J221JW31D	B	82.4/99.7
C251	4030011180	S.CER GRM31M2C2H220JV01L (GRM42-6 CH)	B	134.9/66
C252	4030011180	S.CER GRM31M2C2H220JV01L (GRM42-6 CH)	B	142.2/70.6
C253	4030011080	S.CER GRM31M2C2H6R0DV01L (GRM42-6 CH)	B	145.5/79
C254	4030011160	S.CER GRM31M2C2H150JV01L (GRM42-6 CH)	B	127.7/65.3
C261	4030012480	S.CER GRM31M2C2H121JV01L (GRM42-6 CH)	B	131.7/75.1
C262	4030018940	S.CER GRM31A7U2J331JW31D	B	126/80.1
C263	4030018770	S.CER C3216 CH 2J 102J-T	B	122.1/80.7
C266	4030018950	S.CER GRM31A7U2J681JW31D	B	119.7/80.2
C267	4030018930	S.CER GRM31A7U2J221JW31D	B	124/85.3
C301	4030001100	S.CER GRM216B11H102KA01D (GRM40 B)	B	91.7/100.6
C302	4030001020	S.CER GRM216C21H121JA01D (GRM40 CH)	B	93.8/100.6
C303	4030011600	S.CER C1608 JB 1E 104K-T	B	110.8/85.5
C304	4030017320	S.CER GRM21BB11H104KA01L (GRM40-034)	B	94.8/97.6
C305	4510004591	ELE 16 ME 470 HC		
C306	4030004720	S.CER C2012 JB 1H 102K-T	[EUR] B	83.6/39.8
	4030004720	S.CER C2012 JB 1H 102K-T	[FRA]	
	4030004720	S.CER C2012 JB 1H 102K-T	[ESP]	
	4030004720	S.CER C2012 JB 1H 102K-T	[USA]	
	4030004720	S.CER C2012 JB 1H 102K-T	[EXP]	
	4030004720	S.CER C2012 JB 1H 102K-T	[ITR]	
	4030004720	S.CER C2012 JB 1H 102K-T	[UK]	
	4030004720	S.CER C2012 JB 1H 102K-T	[KOR]	
	4030006860	S.CER C1608 JB 1H 102K-T	[AUS]	
	4030004720	S.CER C2012 JB 1H 102K-T	[CHN]	
C307	4030004720	S.CER C2012 JB 1H 102K-T	[EUR] B	100.6/39.8
	4030004720	S.CER C2012 JB 1H 102K-T	[FRA]	
	4030004720	S.CER C2012 JB 1H 102K-T	[ESP]	
	4030004720	S.CER C2012 JB 1H 102K-T	[USA]	
	4030004720	S.CER C2012 JB 1H 102K-T	[EXP]	
	4030004720	S.CER C2012 JB 1H 102K-T	[ITR]	
	4030004720	S.CER C2012 JB 1H 102K-T	[UK]	
	4030004720	S.CER C2012 JB 1H 102K-T	[KOR]	
	4030006860	S.CER C1608 JB 1H 102K-T	[AUS]	
	4030004720	S.CER C2012 JB 1H 102K-T	[CHN]	
C308	4030004720	S.CER C2012 JB 1H 102K-T	[EUR] B	91.9/10.9
	4030004720	S.CER C2012 JB 1H 102K-T	[FRA]	
	4030004720	S.CER C2012 JB 1H 102K-T	[ESP]	
	4030004720	S.CER C2012 JB 1H 102K-T	[USA]	
	4030004720	S.CER C2012 JB 1H 102K-T	[EXP]	
	4030004720	S.CER C2012 JB 1H 102K-T	[ITR]	
	4030004720	S.CER C2012 JB 1H 102K-T	[UK]	
	4030004720	S.CER C2012 JB 1H 102K-T	[KOR]	
	4030006860	S.CER C1608 JB 1H 102K-T	[AUS]	
	4030004720	S.CER C2012 JB 1H 102K-T	[CHN]	
C309	4030011600	S.CER C1608 JB 1E 104K-T	T	105.8/78.3
C311	4030018750	S.CER C3225 CH 2J 682K-T	B	92.7/78.5
C312	4030018750	S.CER C3225 CH 2J 682K-T	B	84.9/78.5
C313	4030011600	S.CER C1608 JB 1E 104K-T	T	76.8/87.8
C314	4030018750	S.CER C3225 CH 2J 682K-T	B	96.9/77.6
C315	4030018750	S.CER C3225 CH 2J 682K-T	B	80.6/77.6
C319	4030011730	S.CER GRM31M2C2H101JV01L (GRM42-6 CH)	B	110/48.8
C320	4030011730	S.CER GRM31M2C2H101JV01L (GRM42-6 CH)	B	71.1/48.9
C323	4030003810	S.MIC UC342H 1200J-T	B	91.4/46.4
C324	4320001050	S.MIC UC342H 3900J-T	T	94.4/40.2
C325	4320001070	S.MIC UC342H 3300J-T	B	94.4/40.7
C327	4030011790	S.CER GRM55RF52A684ZD01L (GRM44-1)	T	65.9/46.3
C331	4030011600	S.CER C1608 JB 1E 104K-T	T	108.3/78.3
C332	4030011600	S.CER C1608 JB 1E 104K-T	B	69.5/81.4
C333	4030018940	S.CER GRM31A7U2J331JW31D	B	88.4/101.8
C340	4030006860	S.CER C1608 JB 1H 102K-T	B	82.3/107.3
C341	4030006860	S.CER C1608 JB 1H 102K-T	B	92.4/107.4
C342	4030006860	S.CER C1608 JB 1H 102K-T	B	87.1/91.6
C350	4030004720	S.CER C2012 JB 1H 102K-T	[EUR] B	103.4/39.8
	4030004720	S.CER C2012 JB 1H 102K-T	[FRA]	
	4030004720	S.CER C2012 JB 1H 102K-T	[ESP]	
	4030004720	S.CER C2012 JB 1H 102K-T	[USA]	
	4030004720	S.CER C2012 JB 1H 102K-T	[EXP]	
	4030004720	S.CER C2012 JB 1H 102K-T	[ITR]	
	4030004720	S.CER C2012 JB 1H 102K-T	[UK]	
	4030004720	S.CER C2012 JB 1H 102K-T	[KOR]	
	4030004720	S.CER C2012 JB 1H 102K-T	[CHN]	
C351	4030004720	S.CER C2012 JB 1H 102K-T	[EUR] B	106.1/39.8
	4030004720	S.CER C2012 JB 1H 102K-T	[FRA]	
	4030004720	S.CER C2012 JB 1H 102K-T	[ESP]	
	4030004720	S.CER C2012 JB 1H 102K-T	[USA]	
	4030004720	S.CER C2012 JB 1H 102K-T	[EXP]	
	4030004720	S.CER C2012 JB 1H 102K-T	[ITR]	
	4030004720	S.CER C2012 JB 1H 102K-T	[UK]	
	4030004720	S.CER C2012 JB 1H 102K-T	[KOR]	
C353	4030004720	S.CER C2012 JB 1H 102K-T	[EUR] B	86.3/39.8
	4030004720	S.CER C2012 JB 1H 102K-T	[FRA]	
	4030004720	S.CER C2012 JB 1H 102K-T	[ESP]	
	4030004720	S.CER C2012 JB 1H 102K-T	[USA]	
	4030004720	S.CER C2012 JB 1H 102K-T	[EXP]	

[PA UNIT]

REF NO.	PARTS NO.	DESCRIPTION	M.	H/V LOCATION
C353	4030004720	S.CER C2012 JB 1H 102K-T [ITR]	B	86.3/39.8
	4030004720	S.CER C2012 JB 1H 102K-T [UK]		
C354	4030004720	S.CER C2012 JB 1H 102K-T [KOR]	B	89.1/39.8
	4030004720	S.CER C2012 JB 1H 102K-T [CHN]		
	4030004720	S.CER C2012 JB 1H 102K-T [EUR]		
	4030004720	S.CER C2012 JB 1H 102K-T [FRA]		
	4030004720	S.CER C2012 JB 1H 102K-T [ESP]		
	4030004720	S.CER C2012 JB 1H 102K-T [USA]		
	4030004720	S.CER C2012 JB 1H 102K-T [EXP]		
	4030004720	S.CER C2012 JB 1H 102K-T [ITR]		
	4030004720	S.CER C2012 JB 1H 102K-T [UK]		
	4030004720	S.CER C2012 JB 1H 102K-T [KOR]		
C356	4030004720	S.CER C2012 JB 1H 102K-T [CHN]	B	97.5/10.9
	4030004720	S.CER C2012 JB 1H 102K-T [EUR]		
	4030004720	S.CER C2012 JB 1H 102K-T [FRA]		
	4030004720	S.CER C2012 JB 1H 102K-T [ESP]		
	4030004720	S.CER C2012 JB 1H 102K-T [USA]		
	4030004720	S.CER C2012 JB 1H 102K-T [EXP]		
	4030004720	S.CER C2012 JB 1H 102K-T [ITR]		
	4030004720	S.CER C2012 JB 1H 102K-T [UK]		
	4030004720	S.CER C2012 JB 1H 102K-T [KOR]		
	4030004720	S.CER C2012 JB 1H 102K-T [CHN]		
C357	4030004720	S.CER C2012 JB 1H 102K-T [CHN]	B	94.7/10.9
	4030004720	S.CER C2012 JB 1H 102K-T [EUR]		
	4030004720	S.CER C2012 JB 1H 102K-T [FRA]		
	4030004720	S.CER C2012 JB 1H 102K-T [ESP]		
	4030004720	S.CER C2012 JB 1H 102K-T [USA]		
	4030004720	S.CER C2012 JB 1H 102K-T [EXP]		
	4030004720	S.CER C2012 JB 1H 102K-T [ITR]		
	4030004720	S.CER C2012 JB 1H 102K-T [UK]		
	4030004720	S.CER C2012 JB 1H 102K-T [KOR]		
	4030004720	S.CER C2012 JB 1H 102K-T [CHN]		
C358	4030006860	S.CER C1608 JB 1H 102K-T [EUR]	B	90/91.6
	4030006860	S.CER C1608 JB 1H 102K-T [FRA]		
	4030006860	S.CER C1608 JB 1H 102K-T [ESP]		
	4030006860	S.CER C1608 JB 1H 102K-T [USA]		
	4030006860	S.CER C1608 JB 1H 102K-T [EXP]		
	4030006860	S.CER C1608 JB 1H 102K-T [ITR]		
	4030006860	S.CER C1608 JB 1H 102K-T [UK]		
	4030006860	S.CER C1608 JB 1H 102K-T [KOR]		
	4030006860	S.CER C1608 JB 1H 102K-T [CHN]		
	4030006860	S.CER C1608 JB 1H 102K-T [EUR]		
C359	4030006860	S.CER C1608 JB 1H 102K-T [FRA]	B	94.9/107.4
	4030006860	S.CER C1608 JB 1H 102K-T [ESP]		
	4030006860	S.CER C1608 JB 1H 102K-T [USA]		
	4030006860	S.CER C1608 JB 1H 102K-T [EXP]		
	4030006860	S.CER C1608 JB 1H 102K-T [ITR]		
	4030006860	S.CER C1608 JB 1H 102K-T [UK]		
	4030006860	S.CER C1608 JB 1H 102K-T [KOR]		
	4030006860	S.CER C1608 JB 1H 102K-T [CHN]		
	4030006860	S.CER C1608 JB 1H 102K-T [EUR]		
	4030006860	S.CER C1608 JB 1H 102K-T [FRA]		
C360	4030006860	S.CER C1608 JB 1H 102K-T [ESP]	B	85/107.3
	4030006860	S.CER C1608 JB 1H 102K-T [USA]		
	4030006860	S.CER C1608 JB 1H 102K-T [EXP]		
	4030006860	S.CER C1608 JB 1H 102K-T [ITR]		
	4030006860	S.CER C1608 JB 1H 102K-T [UK]		
	4030006860	S.CER C1608 JB 1H 102K-T [KOR]		
	4030006860	S.CER C1608 JB 1H 102K-T [CHN]		
	4030006860	S.CER C1608 JB 1H 102K-T [EUR]		
	4030006860	S.CER C1608 JB 1H 102K-T [FRA]		
	4030006860	S.CER C1608 JB 1H 102K-T [ESP]		
C403	4030006860	S.CER C1608 JB 1H 102K-T [UK]	B	89.6/133.4
C404	4030006860	S.CER C1608 JB 1H 102K-T [KOR]	B	151.7/71.4
C405	4030011740	S.CER GRM32N2C2H201JV01L (GRM42-2 CH)	T	145.3/105.7
C406	4030006860	S.CER C1608 JB 1H 102K-T [UK]	T	132.4/129.7
C408	4030018040	S.CER ERF22X 6C2H 180J D01L	B	134.2/93
C409	4030018040	S.CER ERF22X 6C2H 180J D01L	B	145.4/93
C410	4030018260	S.CER ERF22X 6C2H 150J D01L	B	145.4/96.4
C411	4030018260	S.CER ERF22X 6C2H 150J D01L	B	134.2/96.4
C412	4030018770	S.CER C3216 CH 2J 102J-T	T	136/111.5
C413	4030018770	S.CER C3216 CH 2J 102J-T	T	139.8/102.7
C415	4030018410	S.CER ERF22X 6C2H 2R0C D01L	T	143.1/139.4
C416	4030006880	S.CER C1608 JB 1H 472K-T	T	103.1/96.7
C417	4030018040	S.CER ERF22X 6C2H 180J D01L	T	139.2/136.2
C418	4030011120	S.CER GRM31M2C2H100JV01L (GRM42-6 CH)	B	134.1/134.2
C419	4030011020	S.CER GRM31M4C2H1R0CY21L (GRM42-6 CK)	B	132.6/138.2
C420	4030011080	S.CER GRM31M2C2H6R0DV01L (GRM42-6 CH)	B	129.2/139.5
C421	4030011020	S.CER GRM31M4C2H1R0CY21L (GRM42-6 CK)	B	120.6/136.8
C422	4030011120	S.CER GRM31M2C2H100JV01L (GRM42-6 CH)	B	121.7/141.1
C423	4030007090	S.CER C1608 CH 1H 470J-T	B	127.8/131.7
C424	4030011090	S.CER GRM31M2C2H7R0DV01L (GRM42-6 CH)	B	119/140.3
C425	4030011180	S.CER GRM31M2C2H220JV01L (GRM42-6 CH)	T	121.6/137.4
C426	4030006860	S.CER C1608 JB 1H 102K-T	B	106.7/133.9
C427	4030011020	S.CER GRM31M4C2H1R0CY21L (GRM42-6 CK) [EUR]	B	102.6/139.6
	4030011020	S.CER GRM31M4C2H1R0CY21L (GRM42-6 CK) [FRA]		
	4030011020	S.CER GRM31M4C2H1R0CY21L (GRM42-6 CK) [ESP]		
	4030011020	S.CER GRM31M4C2H1R0CY21L (GRM42-6 CK) [USA]		
	4030011020	S.CER GRM31M4C2H1R0CY21L (GRM42-6 CK) [EXP]		

[PA UNIT]

REF NO.	PARTS NO.	DESCRIPTION	M.	H/V LOCATION
C427	4030011020	S.CER GRM31M4C2H1R0CY21L (GRM42-6 CK) [ITR]	B	102.6/139.6
	4030011040	S.CER GRM31M4C2H2R0CY21L (GRM42-6 CK) [UK]		
	4030011020	S.CER GRM31M4C2H1R0CY21L (GRM42-6 CK) [KOR]		
	4030011020	S.CER GRM31M4C2H1R0CY21L (GRM42-6 CK) [AUS]		
	4030011020	S.CER GRM31M4C2H1R0CY21L (GRM42-6 CK) [CHN]		
C428	4030011090	S.CER GRM31M2C2H7R0DV01L (GRM42-6 CH)	T	97/138.1
C429	4030017940	S.CER ERF22X 6C2H 680J D01L	T	92.3/136.9
C430	4030019410	S.CER GRM31A7U2J471JW31D	B	94.2/138
C431	40300111070	S.CER GRM31M2C2H5R0CY21L (GRM42-6 CH)	T	86.9/133.8
C432	4030004820	S.CER C2012 CH 1H 050C-T	B	99.2/139.3
C433	4030011090	S.CER GRM31M2C2H7R0DV01L (GRM42-6 CH)	T	76.1/132.2
C434	4030006860	S.CER C1608 JB 1H 102K-T	B	89.9/124.9
C435	4030006860	S.CER C1608 JB 1H 102K-T	B	97.2/127.7
C436	4030006860	S.CER C1608 JB 1H 102K-T	T	98.4/130.9
C438	4030006850	S.CER C1608 JB 1H 471K-T	B	90.8/134
C439	4030006860	S.CER C1608 JB 1H 102K-T	B	92.8/133.1
C440	4030004710	S.CER C2012 JB 1H 471K-T	B	103.5/135.5
C441	4030011090	S.CER GRM31M2C2H7R0DV01L (GRM42-6 CH)	T	137.6/140.4
C443	4030011020	S.CER GRM31M4C2H1R0CY21L (GRM42-6 CK)	B	122.1/131
C444	4030006860	S.CER C1608 JB 1H 102K-T	B	59.3/117.9
C452	4030007020	S.CER C1608 CH 1H 120J-T	B	87.3/119.3
C453	4030006860	S.CER C1608 JB 1H 102K-T	T	63.9/117.3
C456	4030009350	S.CER C1608 CH 1H 3R5B-T	B	78.2/118.4
C458	4030006860	S.CER C1608 JB 1H 102K-T	T	73.8/113.1
C461	4030011600	S.CER C1608 JB 1E 104K-T	B	68.8/113.3
C462	4030011600	S.CER C1608 JB 1E 104K-T	B	77.1/110.8
C463	4030006860	S.CER C1608 JB 1H 102K-T	B	79.1/109.6
C464	4030011600	S.CER C1608 JB 1E 104K-T	B	77.7/105.9
C465	4030011600	S.CER C1608 JB 1E 104K-T	B	67.7/108.9
C466	4030006860	S.CER C1608 JB 1H 102K-T	B	77.1/104.6
C467	4030006860	S.CER C1608 JB 1H 102K-T	B	67.7/107.6
C468	4030007020	S.CER C1608 CH 1H 120J-T	B	73.7/101.1
C470	4030011600	S.CER C1608 JB 1E 104K-T	B	77.7/101.7
C471	4030006860	S.CER C1608 JB 1H 102K-T	B	77.7/100.4
C472	4030009500	S.CER C1608 CH 1H 0R5B-T	B	69.7/105.2
C473	4030007040	S.CER C1608 CH 1H 180J-T	B	69.7/104
C474	4030009530	S.CER C1608 CH 1H 030B-T	B	67.7/101.7
C475	4030006860	S.CER C1608 JB 1H 102K-T	B	66.5/98.8
C476	4030006860	S.CER C1608 JB 1H 102K-T	B	68/111.3
C477	4030006860	S.CER C1608 JB 1H 102K-T	B	79.1/121.9
C478	4030006860	S.CER C1608 JB 1H 102K-T	B	57.7/120.5
C479	4030006860	S.CER C1608 JB 1H 102K-T	B	56.9/121.8
C480	4030007090	S.CER C1608 CH 1H 470J-T	B	63.4/100.8
C481	4030006860	S.CER C1608 JB 1H 102K-T	B	69.6/96.3
C482	4030006860	S.CER C1608 JB 1H 102K-T	B	67.9/94.5
C483	4030006860	S.CER C1608 JB 1H 102K-T	B	64.2/98.8
C484	4030007010	S.CER C1608 CH 1H 100D-T	B	64.3/108.1
C485	4030017810	S.CER C1608 CH 1H 102J-T	B	79.8/107.4
C501	4030006860	S.CER C1608 JB 1H 102K-T	T	109.3/87.9
C503	4030011070	S.CER GRM31M2C2H5R0CY21L (GRM42-6 CH)	T	119.4/130.3
C504	4030017960	S.CER ERF22X 6C2H 330J D01L	T	111.8/122.1
C505	4030011040	S.CER GRM31M4C2H2R0CY21L (GRM42-6 CK)	B	114.4/125.4
C506	4030011120	S.CER GRM31M2C2H100JV01L (GRM42-6 CH)	B	118.2/125.6
C507	4030011040	S.CER GRM31M4C2H2R0CY21L (GRM42-6 CK)	B	113.8/131.5
C508	4030011070	S.CER GRM31M2C2H5R0CY21L (GRM42-6 CH)	B	110.4/132.8
C509	4030007150	S.CER C1608 CH 1H 151J-T	B	110.2/121.5
C511	4030018770	S.CER C3216 CH 2J 102J-T	T	109.6/125.4
C513	4030006860	S.CER C1608 JB 1H 102K-T	B	97.1/117.6
C514	4030011170	S.CER GRM31M2C2H180JV01L (GRM42-6 CH)	T	98.4/118.1
C515	4030018770	S.CER C3216 CH 2J 102J-T	T	96.9/120.4
C516	4030011100	S.CER GRM31M2C2H8R0DV01L (GRM42-6 CH)	T	88.2/124.1
C517	4030004880	S.CER C2012 CH 1H 120J-T	B	92.5/115.1
C518	4030018770	S.CER C3216 CH 2J 102J-T	B	94.1/121.4
C519	4030011190	S.CER GRM31M2C2H270JV01L (GRM42-6 CH)	T	86.1/124.1
C520	4030004870	S.CER C2012 CH 1H 100D-T	B	93.4/112.4
C521	4030011290	S.CER GRM31M2C2H240JV01L (GRM42-6 CH)	T	81.2/123.9
C522	4030006850	S.CER C1608 JB 1H 471K-T	T	96.3/107.7
C523	4030006860	S.CER C1608 JB 1H 102K-T	T	79.3/119.1
C524	4030006910	S.CER C1608 CH 1H 0R5C-T	T	79.9/120.9
C525	4030004720	S.CER C2012 JB 1H 102K-T	T	86.7/112.1
C526	4030007150	S.CER C1608 CH 1H 151J-T	B	113.3/121.5
C527	4030007150	S.CER C1608 CH 1H 151J-T	B	111.1/127.8
C528	4030006860	S.CER C1608 JB 1H 102K-T	B	96.2/114.5
C530	4030011230	S.CER GRM31M2C2H390JV01L (GRM42-6 CH)	T	120.8/113.3
C531	4030018770	S.CER C3216 CH 2J 102J-T	B	106/109.3
C532	4030018770	S.CER C3216 CH 2J 102J-T	B	103.1/109.2
C533	4030018770	S.CER C3216 CH 2J 102J-T	T	118.6/107
C534	4030017880	S.CER ERF22X 6C2H 560J D01L (GRM111)	B	112.7/103.9

M.=Mounted side (T: Mounted on the Top side, B: Mounted on the Bottom side) S.=Surface mount

[PA UNIT]

REF NO.	PARTS NO.	DESCRIPTION	M.	H/V LOCATION
C535	4030017880	S.CER ERF22X 6C2H 560J D01L (GRM111)	B	124.1/103.9
C536	4030017980	S.CER ERF22X 6C2H 470J D01L	T	101/110.8
C537	4030017940	S.CER ERF22X 6C2H 680J D01L	T	101/114.2
C538	4030017880	S.CER ERF22X 6C2H 560J D01 (GRM111)	T	131.2/117.5
C541	4030011060	S.CER GRM31M2C2H4R0CY21L (GRM42-6 CH)	T	125.1/123.7
C542	4030012480	S.CER GRM31M2C2H121JV01L (GRM42-6 CH)	T	123.4/128.7
C544	4030011730	S.CER GRM31M2C2H101JV01L (GRM42-6 CH)	T	129.9/123.5
C545	4030017940	S.CER ERF22X 6C2H 680J D01L	B	112.7/109.9
C551	4030006880	S.CER C1608 JB 1H 472K-T	T	80.1/117.1
C552	4030006860	S.CER C1608 JB 1H 102K-T	T	73/120.5
C553	4030006850	S.CER C1608 JB 1H 471K-T	T	69.4/114.7
C554	4030006860	S.CER C1608 JB 1H 102K-T	T	66.8/114.7
C555	4030006860	S.CER C1608 JB 1H 102K-T	T	63.1/111.7
C556	4030011600	S.CER C1608 JB 1E 104K-T	T	68.3/111.2
C557	4030006860	S.CER C1608 JB 1H 102K-T	T	70.8/108.5
C558	4030006860	S.CER C1608 JB 1H 102K-T	T	65.4/108.6
C559	4030006860	S.CER C1608 JB 1H 102K-T	T	66/103.5
C560	4030006860	S.CER C1608 JB 1H 102K-T	B	65.3/112.9
C561	4030006850	S.CER C1608 JB 1H 471K-T	T	70.1/105.3
C562	4030006860	S.CER C1608 JB 1H 102K-T	T	69.2/94.9
C563	4030006860	S.CER C1608 JB 1H 102K-T	T	62.3/106.1
C564	4030006860	S.CER C1608 JB 1H 102K-T	T	65/97
C565	4030006860	S.CER C1608 JB 1H 102K-T	T	62.3/103
C567	4030006860	S.CER C1608 JB 1H 102K-T	T	69.2/120.9
C601	4030011070	S.CER GRM31M2C2H5R0CY21L (GRM42-6 CH)	T	69.5/132.7
C602	4030011090	S.CER GRM31M2C2H7R0DV01L (GRM42-6 CH)	T	67/136.8
C701	4030017320	S.CER GRM21BB11H104KA01L (GRM40-034)	B	109.8/33.4
C702	4030006860	S.CER C1608 JB 1H 102K-T	B	107.7/33.2
C703	4030011600	S.CER C1608 JB 1E 104K-T	B	83.8/16.9
C704	4510004601	ELE 16 ME 1000 HC		
C705	4030011600	S.CER C1608 JB 1E 104K-T	B	79/16.9
C706	4510004601	ELE 16 ME 1000 HC		
C707	4030017320	S.CER GRM21BB11H104KA01L (GRM40-034)	B	67.1/18.6
C708	4030006900	S.CER C1608 JB 1H 103K-T	T	63.2/27.8
C709	4030006860	S.CER C1608 JB 1H 102K-T	T	63.2/26.5
C710	4030006850	S.CER C1608 JB 1H 471K-T	T	63.2/25.2
C711	4030007170	S.CER C1608 CH 1H 221J-T	T	63.2/23.9
C712	4030007170	S.CER C1608 CH 1H 221J-T	B	70.4/18.7
C713	4510004591	ELE 16 ME 470 HC		
C715	4030006860	S.CER C1608 JB 1H 102K-T	B	97.1/118.9
C718	4030011600	S.CER C1608 JB 1E 104K-T	B	128.4/19.3
C719	4030011600	S.CER C1608 JB 1E 104K-T	T	125.8/16.4
C720	4030011600	S.CER C1608 JB 1E 104K-T	B	130.5/38.7
C722	4030007130	S.CER C1608 CH 1H 101J-T	T	88.9/17
C723	4030007130	S.CER C1608 CH 1H 101J-T	T	78.3/3.1
C724	4030011340	S.CER C1608 CH 1H 471J-T	B	134.8/12.2
C725	4550007350	S.TAN F931C226MCMBMA	B	126.6/35.3
C726	4030006860	S.CER C1608 JB 1H 102K-T	B	91.3/111
C727	4030006860	S.CER C1608 JB 1H 102K-T	B	84.4/114.1
C728	4030006860	S.CER C1608 JB 1H 102K-T	B	91.2/112.6
C729	4030006860	S.CER C1608 JB 1H 102K-T	B	65.1/114.8
C732	4030011600	S.CER C1608 JB 1E 104K-T	T	71.8/2.6
C733	4030011600	S.CER C1608 JB 1E 104K-T	T	66.8/12.9
C734	4030006860	S.CER C1608 JB 1H 102K-T	B	63.5/1.8
C735	4030011600	S.CER C1608 JB 1E 104K-T	T	74.1/13.2
C736	4030011600	S.CER C1608 JB 1E 104K-T	B	67.3/1.8
C737	4030011600	S.CER C1608 JB 1E 104K-T	B	65.4/1.8
C738	4030011600	S.CER C1608 JB 1E 104K-T	B	68.2/14.5
C739	4030011600	S.CER C1608 JB 1E 104K-T	B	69.8/14.5
C741	4030011600	S.CER C1608 JB 1E 104K-T	B	78.5/6.4
C742	4030011600	S.CER C1608 JB 1E 104K-T	T	69.4/12.9
C743	4030006860	S.CER C1608 JB 1H 102K-T	T	68.1/12.9
C744	4030011600	S.CER C1608 JB 1E 104K-T	T	70.7/12.9
C745	4030011600	S.CER C1608 JB 1E 104K-T	B	77.7/14.3
C746	4030011600	S.CER C1608 JB 1E 104K-T	B	76.2/15.1
C747	4030011600	S.CER C1608 JB 1E 104K-T	T	98.5/4.1
C749	4030011600	S.CER C1608 JB 1E 104K-T	T	96.6/6.4
C750	4030006880	S.CER C1608 JB 1H 472K-T	T	94.2/6.4
C751	4030006860	S.CER C1608 JB 1H 102K-T	T	95.4/6.4
C752	4030011600	S.CER C1608 JB 1E 104K-T	T	93/6.4
C753	4030006880	S.CER C1608 JB 1H 472K-T	B	59.9/10.7
C754	4030006860	S.CER C1608 JB 1H 102K-T	B	66.6/14.5
C755	4030006860	S.CER C1608 JB 1H 102K-T	B	58.5/119.2
C757	4030011600	S.CER C1608 JB 1E 104K-T	B	76.4/8
C759	4030006880	S.CER C1608 JB 1H 472K-T	T	72.8/13.2
C760	4030006880	S.CER C1608 JB 1H 472K-T	B	74.8/8
C761	4030006880	S.CER C1608 JB 1H 472K-T	B	73.2/8
C762	4030006880	S.CER C1608 JB 1H 472K-T	B	70/8
C763	4030006880	S.CER C1608 JB 1H 472K-T	B	71.6/8
C764	4030006880	S.CER C1608 JB 1H 472K-T	B	61.9/1.8
C765	4030011600	S.CER C1608 JB 1E 104K-T	B	68.9/1.8
C766	4030006860	S.CER C1608 JB 1H 102K-T	B	66.5/8.7
C781	4030006860	S.CER C1608 JB 1H 102K-T	T	73/90.1
C782	4030006900	S.CER C1608 JB 1H 103K-T	T	71.8/84.3
C783	4030006880	S.CER C1608 JB 1H 472K-T	T	71.8/83.1
C801	4030007070	S.CER C1608 CH 1H 330J-T	T	55/58.5
C802	4030009470	S.CER C1608 CH 1H R75C-T	T	53.7/58.5
C803	4030007100	S.CER C1608 CH 1H 560J-T	T	53.8/53.2
C804	4030007030	S.CER C1608 CH 1H 150J-T	T	56.2/52.5
C805	4030007080	S.CER C1608 CH 1H 390J-T	T	53.8/51.6

[PA UNIT]

REF NO.	PARTS NO.	DESCRIPTION	M.	H/V LOCATION
C806	4030006880	S.CER C1608 JB 1H 472K-T	B	47.1/39.8
C807	4030011600	S.CER C1608 JB 1E 104K-T	B	43.2/38.6
C808	4030011600	S.CER C1608 JB 1E 104K-T	B	43.1/44.5
C820	4030011600	S.CER C1608 JB 1E 104K-T	B	54.1/91.2
C821	4030006880	S.CER C1608 JB 1H 472K-T	B	53.5/99.2
C822	4030011510	S.CER GRM31M2C2H560JV01L (GRM42-6 CH)	B	42.2/21.9
C823	4030011190	S.CER GRM31M2C2H270JV01L (GRM42-6 CH)	B	32.9/18.3
C824	4030012480	S.CER GRM31M2C2H121JV01L (GRM42-6 CH)	B	25.1/17.1
C825	4030011240	S.CER GRM31M2C2H470JV01L (GRM42-6 CH)	B	17.9/15.7
C826	4030011550	S.CER GRM31M2C2H680JV01L (GRM42-6 CH)	B	11.2/19.9
C827	4030011510	S.CER GRM31M2C2H560JV01L (GRM42-6 CH)	B	8.8/19.9
C828	4030006880	S.CER C1608 JB 1H 472K-T	T	5.2/106.7
C829	4030011600	S.CER C1608 JB 1E 104K-T	T	2.6/106.7
C830	4030011210	S.CER GRM31M2C2H330JV01L (GRM42-6 CH)	B	22.4/17.1
C831	4030006880	S.CER C1608 JB 1H 472K-T	B	7.5/109.2
C832	4030006880	S.CER C1608 JB 1H 472K-T	B	51.5/95.4
C833	4030011730	S.CER GRM31M2C2H101JV01L (GRM42-6 CH)	B	27.5/17.1
C835	4030012480	S.CER GRM31M2C2H121JV01L (GRM42-6 CH)	B	16.6/107.1
C836	4030012480	S.CER GRM31M2C2H121JV01L (GRM42-6 CH)	B	12.5/107.8
C837	4030012480	S.CER GRM31M2C2H121JV01L (GRM42-6 CH)	B	12.5/105.7
C840	4030011600	S.CER C1608 JB 1E 104K-T	B	42.8/97.3
C841	4030006880	S.CER C1608 JB 1H 472K-T	B	46/98.5
C842	4030011730	S.CER GRM31M2C2H101JV01L (GRM42-6 CH)	B	39/106.8
C843	4010008160	CER HM13SJ SL 431J 500V 1		
C844	4030011730	S.CER GRM31M2C2H101JV01L (GRM42-6 CH)	B	25.9/102.9
C845	4030014460	S.CER GRM31M2C2H820JV01L (GRM42-6 CH)	B	19.7/91.9
C846	4010005370	CER HM11SJ SL 331J 500V 1		
C847	4010005930	CER HM11SJ SL 391J 500V 1		
C848	4030011190	S.CER GRM31M2C2H270JV01L (GRM42-6 CH)	B	12.5/98.2
C849	4030011180	S.CER GRM31M2C2H220JV01L (GRM42-6 CH)	B	12.6/96.1
C850	4010005930	CER HM11SJ SL 391J 500V 1		
C851	4030012480	S.CER GRM31M2C2H121JV01L (GRM42-6 CH)	B	20.2/112
C852	4030006880	S.CER C1608 JB 1H 472K-T	T	5.3/90.5
C853	4030011600	S.CER C1608 JB 1E 104K-T	T	2.6/90.5
C854	4030006880	S.CER C1608 JB 1H 472K-T	B	7.7/92.8
C855	4030011730	S.CER GRM31M2C2H101JV01L (GRM42-6 CH)	B	27.9/104.9
C856	4030011510	S.CER GRM31M2C2H560JV01L (GRM42-6 CH)	B	31.2/105.5
C857	4030012480	S.CER GRM31M2C2H121JV01L (GRM42-6 CH)	B	43.1/108.3
C858	4030011730	S.CER GRM31M2C2H101JV01L (GRM42-6 CH)	B	20.2/109.9
C860	4030011600	S.CER C1608 JB 1E 104K-T	B	43.4/83.8
C861	4030006880	S.CER C1608 JB 1H 472K-T	B	46.6/83.8
C863	4030011170	S.CER GRM31M2C2H180JV01L (GRM42-6 CH)	B	37.5/93.5
C864	4030011510	S.CER GRM31M2C2H560JV01L (GRM42-6 CH)	B	28.5/82.6
C865	4030011110	S.CER GRM31M2C2H9R0DV01L (GRM42-6 CH)	B	29.4/78.6
C866	4030011230	S.CER GRM31M2C2H390JV01L (GRM42-6 CH)	B	24.4/78
C868	4030011240	S.CER GRM31M2C2H470JV01L (GRM42-6 CH)	B	26.8/78.6
C869	4030011180	S.CER GRM31M2C2H220JV01L (GRM42-6 CH)	B	10.3/83.5
C870	4030011170	S.CER GRM31M2C2H180JV01L (GRM42-6 CH)	B	17/77.7
C871	4030006880	S.CER C1608 JB 1H 472K-T	T	5.2/74.4
C872	4030011600	S.CER C1608 JB 1E 104K-T	T	2.5/74.4
C873	4030011070	S.CER GRM31M2C2H5R0CY21L (GRM42-6 CH)	B	33.2/92.6
C874	4030006880	S.CER C1608 JB 1H 472K-T	B	9/74.5
C876	4030011160	S.CER GRM31M2C2H150JV01L (GRM42-6 CH)	B	22/77.4
C880	4030011600	S.CER C1608 JB 1E 104K-T	B	43.4/69.1
C881	4030006880	S.CER C1608 JB 1H 472K-T	B	47/69.1
C882	4010007590	CER HM15SJ SL 681J 500V 1		
C883	4010007590	CER HM15SJ SL 681J 500V 1		
C884	4010005930	CER HM11SJ SL 391J 500V 1		
C885	4320000320	DIP DM20C 222J5		
C886	4030012480	S.CER GRM31M2C2H121JV01L (GRM42-6 CH)	B	31.5/57.2
C887	4030011730	S.CER GRM31M2C2H101JV01L (GRM42-6 CH)	B	33.9/57.2
C889	4030014460	S.CER GRM31M2C2H820JV01L (GRM42-6 CH)	B	18/65.3
C890	4320001250	DIP DM19C 162J5		
C893	4030006880	S.CER C1608 JB 1H 472K-T	T	5.3/58.3
C894	4030011600	S.CER C1608 JB 1E 104K-T	T	2.6/58.3
C900	4030011600	S.CER C1608 JB 1E 104K-T	B	44/54.4

M.=Mounted side (T: Mounted on the Top side, B: Mounted on the Bottom side) S.=Surface mount

[PA UNIT]

REF NO.	PARTS NO.	DESCRIPTION	M.	H/V LOCATION
C901	4030006880	S.CER C1608 JB 1H 472K-T	B	46.8/54.4
C902	4010005870	CER HM95SJ SL 221J 500V 1		
C903	4030011190	S.CER GRM31M2C2H270JV01L (GRM42-6 CH)	B	30.9/42.7
C904	4030014460	S.CER GRM31M2C2H820JV01L (GRM42-6 CH)	B	28.4/42.7
C905	4010005870	CER HM95SJ SL 221J 500V 1		
C906	4030011510	S.CER GRM31M2C2H560JV01L (GRM42-6 CH)	B	17/44
C907	4030011510	S.CER GRM31M2C2H560JV01L (GRM42-6 CH)	B	10.8/49.5
C908	4030006880	S.CER C1608 JB 1H 472K-T	T	5.3/42.1
C909	4030011600	S.CER C1608 JB 1E 104K-T	T	2.6/42.1
C920	4030011600	S.CER C1608 JB 1E 104K-T	B	43.2/25.1
C921	4030006880	S.CER C1608 JB 1H 472K-T	B	47.1/25.4
C922	4010007590	CER HM15SJ SL 681J 500V 1		
C923	4030011730	S.CER GRM31M2C2H101JV01L (GRM42-6 CH)	B	31.4/27.3
C924	4010006410	CER HM13SJ SL 471J 500V 1		
C925	4030014460	S.CER GRM31M2C2H820JV01L (GRM42-6 CH)	B	15.7/29.5
C926	4010006410	CER HM13SJ SL 471J 500V 1		
C927	4010005930	CER HM11SJ SL 391J 500V 1		
C928	4010005930	CER HM11SJ SL 391J 500V 1		
C929	4030006880	S.CER C1608 JB 1H 472K-T	T	5.3/25.8
C930	4030011600	S.CER C1608 JB 1E 104K-T	T	2.6/25.8
C931	4030014460	S.CER GRM31M2C2H820JV01L (GRM42-6 CH)	B	34.1/27.3
C932	4030011730	S.CER GRM31M2C2H101JV01L (GRM42-6 CH)	B	33.3/32.4
C933	4030011730	S.CER GRM31M2C2H101JV01L (GRM42-6 CH)	B	29.7/30.9
C940	4030011600	S.CER C1608 JB 1E 104K-T	B	43.6/11.1
C941	4030006880	S.CER C1608 JB 1H 472K-T	B	43.6/14.2
C942	4030014460	S.CER GRM31M2C2H820JV01L (GRM42-6 CH)	B	39.5/119.2
C943	4030011210	S.CER GRM31M2C2H330JV01L (GRM42-6 CH)	B	28.9/111.7
C944	4030014460	S.CER GRM31M2C2H820JV01L (GRM42-6 CH)	B	24.7/118.4
C945	4030011170	S.CER GRM31M2C2H180JV01L (GRM42-6 CH)	B	16.5/118.1
C947	4030006880	S.CER C1608 JB 1H 472K-T	T	5.3/9.9
C948	4030011600	S.CER C1608 JB 1E 104K-T	T	2.6/9.9
C949	4030011050	S.CER GRM31M3C2H3R0CY21L (GRM42-6 CJ)	B	28.9/109.6
C960	4030010760	S.CER C1608 CH 1H 331J-T	T	18.1/130.2
C961	4030011600	S.CER C1608 JB 1E 104K-T	B	45.1/134.1
C962	4030006880	S.CER C1608 JB 1H 472K-T	B	39/137.8
C963	4030006880	S.CER C1608 JB 1H 472K-T	B	38.7/126.3
C964	4610002120	S.TRI TZB4Z100EB10R00 (TZBX4Z100BE110)	T	3.3/126.6
C966	4030006880	S.CER C1608 JB 1H 472K-T	B	21.2/131.2
C968	4030011340	S.CER C1608 CH 1H 471J-T	B	31/130.5
C969	4030011340	S.CER C1608 CH 1H 471J-T	B	31/133.6
C970	4030010760	S.CER C1608 CH 1H 331J-T	B	22/132.8
C971	4030011340	S.CER C1608 CH 1H 471J-T	B	35.8/133.6
C972	4030011790	S.CER GRM55RF52A684ZD01L (GRM44-1)	B	3.4/136.4
C973	4030007090	S.CER C1608 CH 1H 470J-T	B	8.3/129.8
C979	4030006880	S.CER C1608 JB 1H 472K-T	T	51.8/38.6
C987	4030006880	S.CER C1608 JB 1H 472K-T	B	28.9/3.3
C988	4030006880	S.CER C1608 JB 1H 472K-T	B	26.3/3.3
C989	4030006880	S.CER C1608 JB 1H 472K-T	B	25/2.6
C990	4030006880	S.CER C1608 JB 1H 472K-T	T	20.6/3
C991	4030006880	S.CER C1608 JB 1H 472K-T	T	20.6/4.2
C992	4030006880	S.CER C1608 JB 1H 472K-T	T	20.6/5.4
C993	4030006880	S.CER C1608 JB 1H 472K-T	T	20.6/6.6
C994	4030011600	S.CER C1608 JB 1E 104K-T	B	29.5/6.1
C995	4030006880	S.CER C1608 JB 1H 472K-T	B	23.7/3.4
C996	4030007090	S.CER C1608 CH 1H 470J-T	T	20.6/9
C997	4030007090	S.CER C1608 CH 1H 470J-T	T	20.6/7.8
C998	4030007090	S.CER C1608 CH 1H 470J-T	T	20.6/10.2
C999	4030006880	S.CER C1608 JB 1H 102K-T	T	56.8/9.5
C1000	4030006880	S.CER C1608 JB 1H 102K-T	B	55.5/5
C1001	4030011600	S.CER C1608 JB 1E 104K-T	B	51.6/1.7
C1002	4030006880	S.CER C1608 JB 1H 472K-T	B	27.6/2.6
C1003	4030011600	S.CER C1608 JB 1E 104K-T	T	49.8/7.6
C1004	4030011510	S.CER GRM31M2C2H560JV01L (GRM42-6 CH)	B	39.8/21.9
C1005	4030011550	S.CER GRM31M2C2H680JV01L (GRM42-6 CH)	B	16.8/91.9
C1006	4030014460	S.CER GRM31M2C2H820JV01L (GRM42-6 CH)	B	39/109.2
C1007	4030011550	S.CER GRM31M2C2H680JV01L (GRM42-6 CH)	B	18.1/62.1
C1009	4030011510	S.CER GRM31M2C2H560JV01L (GRM42-6 CH)	B	20.6/118.7
C1010	4030014460	S.CER GRM31M2C2H820JV01L (GRM42-6 CH)	B	27.1/119.5
C1121	4010006410	CER HM13SJ SL 471J 500V 1		
RL701	6330001550	REL JV-12-KT		
RL801	6330001721	REL ATN207-K1		
RL820	6330001721	REL ATN207-K1		
RL821	6330001721	REL ATN207-K1		
RL840	6330001721	REL ATN207-K1		
RL841	6330001721	REL ATN207-K1		

[PA UNIT]

REF NO.	PARTS NO.	DESCRIPTION	M.	H/V LOCATION
RL860	6330001721	REL ATN207-K1		
RL861	6330001721	REL ATN207-K1		
RL880	6330001721	REL ATN207-K1		
RL881	6330001721	REL ATN207-K1		
RL900	6330001721	REL ATN207-K1		
RL901	6330001721	REL ATN207-K1		
RL920	6330001721	REL ATN207-K1		
RL921	6330001721	REL ATN207-K1		
RL940	6330001721	REL ATN207-K1		
RL941	6330001721	REL ATN207-K1		
J2	6510023511	S.CON 28FLT-SM2-TB(LF)(SN) 2	T	80.1/6
J980	6510023511	S.CON 28FLT-SM2-TB(LF)(SN) 2	T	63.7/6
F1	5220000341	HOL FHA010-03F		
F2	5210000940	FUS 1205		
W701	8900013900	CAB OPC-1455		
W702	8900013910	CAB OPC-1456		
W801	7120000480	S.JUM MJP-0.4-T	B	8.3/100.9
W901	7120000480	S.JUM MJP-0.4-T	T	56.7/22
EP202	6910012350	S.BEA MMZ1608Y 102BT	B	136/51.3
EP703	6910012350	S.BEA MMZ1608Y 102BT	B	142.6/13.9
EP741	6910012350	S.BEA MMZ1608Y 102BT	B	76.4/11.9
EP742	6910012350	S.BEA MMZ1608Y 102BT	B	77.8/11.3
EP743	6910012350	S.BEA MMZ1608Y 102BT	B	59.8/99.5
EP747	6910012350	S.BEA MMZ1608Y 102BT	T	65/9.6
EP748	6910012350	S.BEA MMZ1608Y 102BT	T	63.8/9.6
EP751	6910012350	S.BEA MMZ1608Y 102BT	T	74.1/9.6
EP752	6910012350	S.BEA MMZ1608Y 102BT	B	63.4/5.2
EP753	6910012350	S.BEA MMZ1608Y 102BT	T	66.4/9.6
EP754	6910012350	S.BEA MMZ1608Y 102BT	B	59.3/115.8
EP756	6910012350	S.BEA MMZ1608Y 102BT	T	68.6/2.6
EP758	6910012350	S.BEA MMZ1608Y 102BT	T	70.3/9.6
EP759	6910012350	S.BEA MMZ1608Y 102BT	T	69.1/9.6
EP760	6910012350	S.BEA MMZ1608Y 102BT	T	60.6/10
EP761	6910012350	S.BEA MMZ1608Y 102BT	T	62.5/9.6
EP762	6910012350	S.BEA MMZ1608Y 102BT	B	61/4.6
EP763	6910012350	S.BEA MMZ1608Y 102BT	B	63.3/105.6
EP767	6910012350	S.BEA MMZ1608Y 102BT	B	76.4/5.2
EP772	6910012350	S.BEA MMZ1608Y 102BT	T	96.4/3.8
EP774	6910012350	S.BEA MMZ1608Y 102BT	T	72.8/9.6
EP775	6910012350	S.BEA MMZ1608Y 102BT	B	74.8/5.2
EP776	6910012350	S.BEA MMZ1608Y 102BT	B	73.2/5.2
EP777	6910012350	S.BEA MMZ1608Y 102BT	B	70/5.2
EP778	6910012350	S.BEA MMZ1608Y 102BT	B	71.6/5.2
EP779	6910012350	S.BEA MMZ1608Y 102BT	B	68.2/5.2

M.=Mounted side (T: Mounted on the Top side, B: Mounted on the Bottom side)
S.=Surface mount

[DRIVER UNIT]

REF NO.	PARTS NO.	DESCRIPTION	M.	H/V LOCATION
Q504	1590003061	S.FET PD55015-E	T	20/9.7
R102	7070000271	RES ERG1SJ 101 (100)		
C101	4030004750	S.CER C2012 JB 1H 103K-T	T	24.6/18.2
C102	4030011230	S.CER GRM31M2C2H390JV01L (GRM42-6 CH)	T	11.2/4.2
J101	6910016830	CON IMSA-9230B-1-04Z149-PT1		
J102	6910016830	CON IMSA-9230B-1-04Z149-PT1		
J103	6910016830	CON IMSA-9230B-1-04Z149-PT1		
J104	6910016830	CON IMSA-9230B-1-04Z149-PT1		
J107	6910016830	CON IMSA-9230B-1-04Z149-PT1		
MP1	8410002480	S.HEA 2429 PA HEATSINK	B	20/9.7

[DISPLAY UNIT]

REF NO.	PARTS NO.	DESCRIPTION	M.	H/V LOCATION
IC1	6910016730	S.DC XC9504B092ARN	B	44.4/9.4
IC101	1180001071	S.IC TA7805F(TE16L,Q)	B	90.3/6.9
IC151	1180002201	S.IC RN5RZ33BA-TR-F	B	99.9/4.8
IC301	1110002751	S.IC TA75S01F(TE85R,F)	B	113.8/7.5
IC506	1120003010	S.IC AN2533FH-V	B	69/38.5
IC651	1110005420	S.IC BA15532F-E2	B	4.1/25.6
IC2003	1140013140	S.IC HD64338020SB68HV(SX-2427C)	B	93/26.3
IC2007	1110005821	S.IC R3112N281A-TR-F	B	108.7/46.9
Q1	1550000090	S.FET RSQ035P03TR	B	39.4/9.8
Q51	1560001330	S.FET RSR025N03	B	52.1/10.6
Q301	1560001290	S.FET 2SK3065 T100	T	110.8/31.4
Q302	1590003940	S.TRA RN1105(TE85L,F)	T	116.7/10.2
Q303	1590003930	S.TRA UMD22N TR	T	113.1/11.5
Q651	1590001650	S.TRA XP4601(TX)	B	10.6/28.8
Q652	1590001650	S.TRA XP4601(TX)	B	11.1/20.6
Q653	1590001650	S.TRA XP4601(TX)	B	10.6/26.2
Q654	1590001650	S.TRA XP4601(TX)	B	11.1/17
Q701	1530002060	S.TRA 2SC4081 T106 R	T	19.1/50.3
Q721	1530002060	S.TRA 2SC4081 T106 R	T	22/5.8
Q741	1530002060	S.TRA 2SC4081 T106 R	T	94/50.1
Q761	1530002060	S.TRA 2SC4081 T106 R	T	104.2/50.1
Q771	1530002060	S.TRA 2SC4081 T106 R	T	18.4/25.1
Q781	1530002060	S.TRA 2SC4081 T106 R	T	5.3/23.6
Q802	1520000460	S.TRA 2SB1132 T100 R	B	58.8/21.6
Q851	1590002771	S.FET CPH3404-TL-E	B	39.9/18.4
Q2001	1590003940	S.TRA RN1105(TE85L,F)	B	81.6/23.7
Q2002	1590001870	S.TRA DTA114EE TL	B	80.1/29.7
Q2003	1590003480	S.TRA DTC114TE TL	B	82.2/32.3
D1	1790000970	S.DIO MA729(TX)	B	36.8/10.1
D51	1750000730	S.DIO MA25D1000L	B	51/8
D301	1790001250	S.DIO MA2S111-(TX)	B	111/32
D302	1790001520	S.ZEN MA8075-L(TX)	B	109.9/7.6
D601	1750000950	S.DIO MA732(TX)	B	51.5/39.8
D602	1750000950	S.DIO MA732(TX)	B	53.3/39.8
D801	1730002340	S.ZEN MA8047-M(TX)	B	35/40.4
D802	1730002340	S.ZEN MA8047-M(TX)	B	39.8/25.9
D803	1730002340	S.ZEN MA8047-M(TX)	B	39.5/22.8
D804	1730002340	S.ZEN MA8047-M(TX)	B	42/22.9
D2001	1750000950	S.DIO MA732(TX)	T	107.4/26.5
D2002	1790001670	S.DIO RB706F-40T106	B	76.6/16.8
D2003	1790001670	S.DIO RB706F-40T106	T	116.4/36.7
D2004	1750000370	S.DIO DA221 TL	T	100.6/41.8
D2005	1750000370	S.DIO DA221 TL	B	101.7/42.8
D2006	1750000370	S.DIO DA221 TL	B	107.3/5.9
X501	6050012150	S.XTA CR-806 SMD-49TA 4.433619MHz [EUR]	B	87/43.5
	6050012150	S.XTA CR-806 SMD-49TA 4.433619 MHz [FRA]		
	6050012150	S.XTA CR-806 SMD-49TA 4.433619 MHz [ESP]		
	6050012140	S.XTA CR-805 SMD-49TA 3.579545 MHz [USA]		
	6050012150	S.XTA CR-806 SMD-49TA 4.433619 MHz [EXP]		
	6050012150	S.XTA CR-806 SMD-49TA 4.433619 MHz [ITR]		
	6050012150	S.XTA CR-806 SMD-49TA 4.433619 MHz [UK]		
	6050012140	S.XTA CR-805 SMD-49TA 3.579545 MHz [KOR]		
	6050012150	S.XTA CR-806 SMD-49TA 4.433619 MHz [AUS]		
	6050012150	S.XTA CR-806 SMD-49TA 4.433619 MHz [CHN]		
X2001	6050011550	S.XTA CR-747 SMD-49TA 9.8304 MHz	B	106.5/27

[DISPLAY UNIT]

REF NO.	PARTS NO.	DESCRIPTION	M.	H/V LOCATION
L1	6190001561	S.COI CDRH5D18NP-101NC	B	68.4/6.3
L2	6190001561	S.COI CDRH5D18NP-101NC	B	34.6/5.2
L3	6200002041	S.COI NLV25T-101J	B	30.7/10.4
L51	6190001561	S.COI CDRH5D18NP-101NC	B	55.9/6.2
L53	6200002041	S.COI NLV25T-101J	B	60.9/10.9
L101	6200001831	S.COI NLV32T-100J	B	96/11.6
L151	6200001831	S.COI NLV32T-100J	B	96/8.6
L152	6200001831	S.COI NLV32T-100J	B	100.6/11.4
L251	6200003950	S.COI HF50ACC 322513-T	B	145.8/44
L252	6200003950	S.COI HF50ACC 322513-T	B	145.2/50.9
L301	6200002041	S.COI NLV25T-101J	B	109.6/16.7
L302	6200005011	S.COI NLV25T-100J	T	112.6/24
L303	6200002041	S.COI NLV25T-101J	T	112/20.3
L306	6200003261	S.COI NLV32T-101J	T	109.8/25.5
L307	6200002041	S.COI NLV25T-101J	T	115.4/26.6
L309	6200002041	S.COI NLV25T-101J	T	115.3/24
L310	6200002041	S.COI NLV25T-101J	T	115.4/21.5
L312	6200002041	S.COI NLV25T-101J	T	115.4/19
L313	6200002041	S.COI NLV25T-101J	T	115.7/16.3
L505	6200005521	S.COI NLV25T-470J	B	71.2/47.9
L506	6200005011	S.COI NLV25T-100J	B	67.9/20.2
L507	6200005011	S.COI NLV25T-100J	B	50.2/29
L508	6200005011	S.COI NLV25T-100J	B	49.3/24.3
L509	6200005011	S.COI NLV25T-100J	B	17.4/35.6
L601	6200002041	S.COI NLV25T-101J	B	70.6/25.2
L602	6200005011	S.COI NLV25T-100J	B	53.5/36.2
L603	6200005011	S.COI NLV25T-100J	B	51/43.3
L604	6200005011	S.COI NLV25T-100J	B	53.5/43.3
L605	6200005011	S.COI NLV25T-100J	B	50.9/36.2
L651	6200002041	S.COI NLV25T-101J	B	19.1/42.7
L701	6200002041	S.COI NLV25T-101J	B	21.1/37.5
L702	6200002041	S.COI NLV25T-101J	B	65.4/10.9
L703	6200002041	S.COI NLV25T-101J	B	27.9/11.3
L801	6200005011	S.COI NLV25T-100J	B	63.4/16.9
L802	6200002041	S.COI NLV25T-101J	B	19.1/47.5
L851	6200003950	S.COI HF50ACC 322513-T	B	33.2/17.2
L852	6200003950	S.COI HF50ACC 322513-T	B	35/21.3
L853	6200002041	S.COI NLV25T-101J	B	34.4/26.6
L854	6200002041	S.COI NLV25T-101J	B	34.4/24.1
L855	6200003950	S.COI HF50ACC 322513-T	B	36.4/17.2
R1	7030008141	S.RES ERA3YKD 224V (220K)	B	33.4/9.6
R2	7030005671	S.RES ERA3YKD 393V (39K)	B	33.4/11.6
R3	7030008051	S.RES ERA3YKD 184V (180K)	B	42.6/6.4
R4	7030005050	S.RES ERJ2GEJ 103 X (10K)	B	40.9/6.8
R5	7030005050	S.RES ERJ2GEJ 103 X (10K)	B	40.9/7.7
R51	7030008141	S.RES ERA3YKD 224V (220K)	B	49.7/10.8
R52	7030007911	S.RES ERA3YKD 563V (56K)	B	48.5/10.8
R53	7030006561	S.RES ERA3YED 223V (22K)	B	46.5/11.8
R54	7030005050	S.RES ERJ2GEJ 103 X (10K)	B	47.9/8.4
R55	7030005050	S.RES ERJ2GEJ 103 X (10K)	B	48.8/8.4
R201	7030010040	S.RES ERJ2GEJ-JPW	B	109.6/38
R202	7030010040	S.RES ERJ2GEJ-JPW	B	109.6/39
R251	7030005120	S.RES ERJ2GEJ 102 X (1K)	B	136.5/49.6
R252	7030000300	S.RES MCR10EZHZJ 220 (221)	B	133.9/47.3
R253	7030000300	S.RES MCR10EZHZJ 220 (221)	B	141.3/51.5
R254	7030000300	S.RES MCR10EZHZJ 220 (221)	B	133.9/49
R255	7030000300	S.RES MCR10EZHZJ 220 (221)	T	142.6/51.4
R301	7030005120	S.RES ERJ2GEJ 102 X (1K)	B	113.2/30
R302	7030005050	S.RES ERJ2GEJ 103 X (10K)	T	114/30.2
R303	7030005120	S.RES ERJ2GEJ 102 X (1K)	B	111/33.4
R304	7030007300	S.RES ERJ2GEJ 332 X (3.3K)	B	111.9/33.4
R305	7030007300	S.RES ERJ2GEJ 332 X (3.3K)	B	113.2/32.9
R306	7030005120	S.RES ERJ2GEJ 102 X (1K)	T	114.9/11
R307	7030005050	S.RES ERJ2GEJ 103 X (10K)	B	111.3/8.4
R308	7030005230	S.RES ERJ2GEJ 334 X (330K)	B	113.8/5.3
R309	7030005310	S.RES ERJ2GEJ 124 X (120K)	B	112/5.3
R310	7030008010	S.RES ERJ2GEJ 123 X (12K)	B	110.2/5.3
R521	7030008370	S.RES ERJ2GEJ 561 X (560)	B	61.8/46.2
R522	7030010040	S.RES ERJ2GEJ-JPW	B	65.3/47.4
R523	7030010040	S.RES ERJ2GEJ-JPW	B	65.4/48.7
R524	7030010900	S.RES ERJ3GEJY 750 V (75)	B	63.1/48.9
R528	7030010040	S.RES ERJ2GEJ-JPW	B	60.8/42.6
R529	7030005050	S.RES ERJ2GEJ 103 X (10K)	B	58.6/43.8
R530	7030005080	S.RES ERJ2GEJ 823 X (82K)	B	60.8/43.6
R531	7030009290	S.RES ERJ2GEJ 562 X (5.6K)	B	76.3/42.9
R532	7030005050	S.RES ERJ2GEJ 103 X (10K)	B	60.8/37.2
R533	7030010040	S.RES ERJ2GEJ-JPW	B	56.5/32.3
R534	7030010040	S.RES ERJ2GEJ-JPW	B	60.8/36
R536	7030010040	S.RES ERJ2GEJ-JPW	B	62.6/29
R537	7030010040	S.RES ERJ2GEJ-JPW	B	64.6/29
R538	7030010040	S.RES ERJ2GEJ-JPW	B	66.6/29
R539	7030005720	S.RES ERJ2GEJ 563 X (56K)	B	69.6/29
R540	7030010040	S.RES ERJ2GEJ-JPW	B	68.6/29
R541	7310004650	S.TRI EVM-2WSX80 B53 (502)	B	53.3/49.2
R544	7030010040	S.RES ERJ2GEJ-JPW	B	60.8/39.6
R545	7030005720	S.RES ERJ2GEJ 563 X (56K)	B	60.8/32
R546	7030010040	S.RES ERJ2GEJ-JPW	B	60.8/34
R547	7030010040	S.RES ERJ2GEJ-JPW	B	59.2/34.8
R548	7030010040	S.RES ERJ2GEJ-JPW	B	60.8/33
R549	7030010040	S.RES ERJ2GEJ-JPW	B	63.6/29
R550	7030010040	S.RES ERJ2GEJ-JPW	B	65.6/29
R551	7030010040	S.RES ERJ2GEJ-JPW	B	67.6/29
R553	7030010040	S.RES ERJ2GEJ-JPW	B	59.5/43.8
R601	7030008410	S.RES ERJ2GEJ 392 X (3.9K)	B	72.7/24.9
R602	7030008410	S.RES ERJ2GEJ 392 X (3.9K)	B	74.5/24.9
R603	7030008410	S.RES ERJ2GEJ 392 X (3.9K)	B	75.4/24.9
R604	7030008410	S.RES ERJ2GEJ 392 X (3.9K)	B	77.2/24.9

M.=Mounted side (T: Mounted on the Top side, B: Mounted on the Bottom side) S.=Surface mount

[DISPLAY UNIT]

REF NO.	PARTS NO.	DESCRIPTION	M.	H/V LOCATION
R605	7030008410	S.RES ERJ2GEJ 392 X (3.9K)	B	75.3/30.2
R606	7030008410	S.RES ERJ2GEJ 392 X (3.9K)	B	76.3/24.9
R608	7030010040	S.RES ERJ2GEJ-JPW	B	48.8/36.8
R609	7030005040	S.RES ERJ2GEJ 472 X (4.7K)	B	48.4/44.4
R610	7030010040	S.RES ERJ2GEJ-JPW	B	48.8/41.7
R612	7030005040	S.RES ERJ2GEJ 472 X (4.7K)	B	48.8/42.6
R613	7030003470	S.RES ERJ3GEYJ 182 V (1.8K)	B	52.6/46.1
R614	7030003470	S.RES ERJ3GEYJ 182 V (1.8K)	B	50.7/46.3
R651	7030005050	S.RES ERJ2GEJ 103 X (10K)	B	5.5/19.6
R652	7030005220	S.RES ERJ2GEJ 223 X (22K)	B	8.1/25.7
R653	7030005060	S.RES ERJ2GEJ 333 X (33K)	B	5.5/21.4
R654	7030005070	S.RES ERJ2GEJ 683 X (68K)	B	8.1/23.9
R655	7030005090	S.RES ERJ2GEJ 104 X (100K)	B	4.1/30.7
R656	7030005110	S.RES ERJ2GEJ 224 X (220K)	B	8.1/27.4
R657	7030005060	S.RES ERJ2GEJ 333 X (33K)	B	1.8/30.3
R658	7030005090	S.RES ERJ2GEJ 104 X (100K)	B	4.1/29.8
R659	7030003600	S.RES ERJ3GEYJ 223 V (22K)	B	8.4/28.5
R660	7030005720	S.RES ERJ2GEJ 563 X (56K)	B	13.2/29.9
R661	7030005220	S.RES ERJ2GEJ 223 X (22K)	B	13.7/27.1
R662	7030007350	S.RES ERJ2GEJ 393 X (39K)	B	13.7/28.7
R663	7030005220	S.RES ERJ2GEJ 223 X (22K)	B	13.2/20.6
R664	7030007340	S.RES ERJ2GEJ 153 X (15K)	B	5.7/29.8
R665	7030003600	S.RES ERJ3GEYJ 223 V (22K)	B	8.9/20.6
R666	7030004980	S.RES ERJ2GEJ 101 X (100)	B	13.1/25.3
R667	7030004980	S.RES ERJ2GEJ 101 X (100)	B	11.1/18.8
R668	7030004980	S.RES ERJ2GEJ 101 X (100)	B	9.7/24.2
R669	7030004980	S.RES ERJ2GEJ 101 X (100)	B	13.6/16.2
R701	7030004990	S.RES ERJ2GEJ 221 X (220)	T	18.4/48
R702	7030007280	S.RES ERJ2GEJ 331 X (330)	T	19.7/48
R703	7030007290	S.RES ERJ2GEJ 222 X (2.2K)	T	25.1/41
R704	7030005040	S.RES ERJ2GEJ 472 X (4.7K)	T	16.6/17.2
R705	7030007340	S.RES ERJ2GEJ 153 X (15K)	T	18.7/6.4
R721	7030004990	S.RES ERJ2GEJ 221 X (220)	T	20.2/6.2
R722	7030007280	S.RES ERJ2GEJ 331 X (330)	T	23.8/5.6
R723	7030003480	S.RES ERJ3GEYJ 222 V (2.2K)	T	47.5/2.4
R724	7030003520	S.RES ERJ3GEYJ 472 V (4.7K)	T	61.8/2.4
R725	7030003580	S.RES ERJ3GEYJ 153 V (15K)	T	75.9/2.4
R741	7030004990	S.RES ERJ2GEJ 221 X (220)	T	92.2/49.7
R742	7030007280	S.RES ERJ2GEJ 331 X (330)	T	95.7/49.6
R743	7030007290	S.RES ERJ2GEJ 222 X (2.2K)	T	102.1/35
R744	7030005040	S.RES ERJ2GEJ 472 X (4.7K)	T	102.1/25.5
R745	7030007340	S.RES ERJ2GEJ 153 X (15K)	T	100.6/8.6
R761	7030004990	S.RES ERJ2GEJ 221 X (220)	T	103.1/48.2
R762	7030007280	S.RES ERJ2GEJ 331 X (330)	T	104.8/47.8
R771	7030004990	S.RES ERJ2GEJ 221 X (220)	T	18.7/28.9
R772	7030007280	S.RES ERJ2GEJ 331 X (330)	T	18.1/29.9
R781	7030004990	S.RES ERJ2GEJ 221 X (220)	T	3.5/22.4
R782	7030007280	S.RES ERJ2GEJ 331 X (330)	T	3.5/24.2
R801	7030005240	S.RES ERJ2GEJ 473 X (47K)	B	62/21.8
R802	7030007270	S.RES ERJ2GEJ 151 X (150)	B	62/20
R803	7030005120	S.RES ERJ2GEJ 102 X (1K)	B	62/23.6
R2002	7030005240	S.RES ERJ2GEJ 473 X (47K)	T	110.4/40.7
R2003	7030005050	S.RES ERJ2GEJ 103 X (10K)	T	24.6/24.1
R2004	7030005050	S.RES ERJ2GEJ 103 X (10K)	T	24.6/26.3
R2005	7030005050	S.RES ERJ2GEJ 103 X (10K)	T	24.6/23.2
R2006	7030005050	S.RES ERJ2GEJ 103 X (10K)	T	24.6/25.3
R2007	7030007290	S.RES ERJ2GEJ 222 X (2.2K)	T	107.6/24.4
R2008	7030005220	S.RES ERJ2GEJ 223 X (22K)	T	78.2/18.4
R2009	7030005240	S.RES ERJ2GEJ 473 X (47K)	T	107.8/33
R2010	7030005090	S.RES ERJ2GEJ 104 X (100K)	T	79.6/16.9
R2011	7030005160	S.RES ERJ2GEJ 105 X (1M)	B	103.3/26.9
R2012	7030008010	S.RES ERJ2GEJ 123 X (12K)	B	96.3/23.3
R2013	7030005240	S.RES ERJ2GEJ 473 X (47K)	B	103.7/37.9
R2014	7030005290	S.RES ERJ2GEJ 682 X (6.8K)	T	24.1/41
R2015	7030005050	S.RES ERJ2GEJ 103 X (10K)	B	106/44.6
R2016	7030005240	S.RES ERJ2GEJ 473 X (47K)	B	92.1/37.9
R2017	7030005290	S.RES ERJ2GEJ 682 X (6.8K)	T	33.4/3.7
R2018	7030005290	S.RES ERJ2GEJ 682 X (6.8K)	T	102.2/41.8
R2019	7030005240	S.RES ERJ2GEJ 473 X (47K)	B	84.8/33.8
R2020	7030003450	S.RES ERJ3GEYJ 122 V (1.2K)	B	91.2/43.1
R2021	7030005240	S.RES ERJ2GEJ 473 X (47K)	B	97.1/40.8
R2022	7030005240	S.RES ERJ2GEJ 473 X (47K)	B	92.3/42.8
R2023	7030005240	S.RES ERJ2GEJ 473 X (47K)	B	100.1/42.8
R2024	7030005240	S.RES ERJ2GEJ 473 X (47K)	B	94.3/42.3
R2025	7030005240	S.RES ERJ2GEJ 473 X (47K)	B	93.3/42.3
R2026	7030005240	S.RES ERJ2GEJ 473 X (47K)	B	72.4/16.7
R2027	7030005240	S.RES ERJ2GEJ 473 X (47K)	B	70.6/16.9
R2028	7030005240	S.RES ERJ2GEJ 473 X (47K)	B	98.9/42.8
R2029	7030005240	S.RES ERJ2GEJ 473 X (47K)	B	73.5/16.7
R2030	7030007270	S.RES ERJ2GEJ 151 X (150)	T	108/11.8
R2031	7030007280	S.RES ERJ2GEJ 331 X (330)	T	108.8/40.1
R2033	7030007270	S.RES ERJ2GEJ 151 X (150)	T	19.4/20.3
R2034	7030005120	S.RES ERJ2GEJ 102 X (1K)	B	32.1/28.3
R2035	7030005120	S.RES ERJ2GEJ 102 X (1K)	B	32.5/30.9
R2036	7030005240	S.RES ERJ2GEJ 473 X (47K)	B	94.9/37.9
R2037	7030005240	S.RES ERJ2GEJ 473 X (47K)	B	93.9/37.9
R2039	7030005240	S.RES ERJ2GEJ 473 X (47K)	T	107.6/23.5
R2040	7030007340	S.RES ERJ2GEJ 153 X (15K)	B	116.3/8.7
R2041	7030007340	S.RES ERJ2GEJ 153 X (15K)	B	116.2/7.7
R2042	7030005050	S.RES ERJ2GEJ 103 X (10K)	B	79.7/31.3
R2043	7030005090	S.RES ERJ2GEJ 104 X (100K)	B	81.9/30.4
C2	4030018960	S.CER C3216 JB 1C 106MT-N	B	62.2/7
C3	4030018960	S.CER C3216 JB 1C 106MT-N	B	77/9.8
C4	4030017420	S.CER ECJ0EC1H470J	B	35.3/10.6
C6	4030018960	S.CER C3216 JB 1C 106MT-N	B	28/6
C8	4030018960	S.CER C3216 JB 1C 106MT-N	B	30.1/6
C9	4030018960	S.CER C3216 JB 1C 106MT-N	B	39.1/4.4

[DISPLAY UNIT]

REF NO.	PARTS NO.	DESCRIPTION	M.	H/V LOCATION
C51	4030017420	S.CER ECJ0EC1H470J	B	49.7/8.4
C53	4030018960	S.CER C3216 JB 1C 106MT-N	B	51.6/4.3
C55	4030018960	S.CER C3216 JB 1C 106MT-N	B	56.2/11
C56	4030018960	S.CER C3216 JB 1C 106MT-N	B	61.9/3.6
C57	4030017490	S.CER C1608 JB 1A 105K-T	B	43.9/11.8
C101	4030018960	S.CER C3216 JB 1C 106MT-N	B	85.7/6.3
C102	4030018960	S.CER C3216 JB 1C 106MT-N	B	94.7/4.6
C103	4030016930	S.CER ECJ0EB1A104K	B	91.1/12.2
C104	4030016930	S.CER ECJ0EB1A104K	B	89.5/12.2
C151	4550006250	S.TAN TEESVA 1A 106M8R	B	97/4.6
C152	4550006250	S.TAN TEESVA 1A 106M8R	B	100.7/7.7
C153	4030016930	S.CER ECJ0EB1A104K	B	99.7/2.6
C154	4030016930	S.CER ECJ0EB1A104K	B	99.6/9.3
C251	4030017730	S.CER ECJ0EB1E471K	B	147.5/46.4
C252	4030017730	S.CER ECJ0EB1E471K	B	146.5/48.3
C253	4030017730	S.CER ECJ0EB1E471K	B	144.7/48.3
C254	4030017730	S.CER ECJ0EB1E471K	B	144.4/46.4
C255	4030017490	S.CER C1608 JB 1A 105K-T	T	147.1/51
C256	4030017490	S.CER C1608 JB 1A 105K-T	B	134.1/45.7
C301	4030017780	S.CER ECJ0EB1E472K	T	108.3/19.9
C302	4030017780	S.CER ECJ0EB1E472K	T	108.2/28.7
C303	4030006880	S.CER C1608 JB 1H 472K-T	T	113/27
C304	4030017780	S.CER ECJ0EB1E472K	B	113.2/33.8
C305	4030017780	S.CER ECJ0EB1E472K	T	114.9/12.6
C306	4030017780	S.CER ECJ0EB1E472K	B	113.8/4.3
C312	4030017780	S.CER ECJ0EB1E472K	T	108.2/29.6
C315	4030017780	S.CER ECJ0EB1E472K	B	25.2/19.9
C316	4030017780	S.CER ECJ0EB1E472K	B	26.1/19.9
C317	4030017780	S.CER ECJ0EB1E472K	B	27/19.9
C318	4030017780	S.CER ECJ0EB1E472K	B	23.9/19.8
C319	4030017780	S.CER ECJ0EB1E472K	B	27.2/32.5
C320	4030017780	S.CER ECJ0EB1E472K	B	26.3/32.5
C321	4030017780	S.CER ECJ0EB1E472K	B	25.5/31.1
C322	4030017780	S.CER ECJ0EB1E472K	T	24.6/27.3
C501	4550007140	S.TAN TEESVD 1C 107M12R	B	53.3/20.9
C502	4550007140	S.TAN TEESVD 1C 107M12R	B	45.3/20.9
C513	4030016930	S.CER ECJ0EB1A104K	B	64.3/47.4
C514	4030016930	S.CER ECJ0EB1A104K	B	63.3/47.4
C515	4030017490	S.CER C1608 JB 1A 105K-T	B	61.5/44.9
C516	4030018910	S.CER C1608 JB 0J 475K-T	B	67.7/48.9
C517	4030017490	S.CER C1608 JB 1A 105K-T	B	75.6/47.9
C518	4030017650	S.CER ECJ0EC1H270J	[EUR]	73.4/47.4
	4030017650	S.CER ECJ0EC1H270J	[FRA]	
	4030017650	S.CER ECJ0EC1H270J	[ESP]	
	4030017670	S.CER ECJ0EC1H390J	[USA]	
	4030017650	S.CER ECJ0EC1H270J	[EXP]	
	4030017650	S.CER ECJ0EC1H270J	[ITR]	
	4030017650	S.CER ECJ0EC1H270J	[UK]	
	4030017670	S.CER ECJ0EC1H390J	[KOR]	
	4030017650	S.CER ECJ0EC1H270J	[AUS]	
	4030017650	S.CER ECJ0EC1H270J	[CHN]	
C519	4030016930	S.CER ECJ0EB1A104K	B	76.9/48.4
C520	4030016930	S.CER ECJ0EB1A104K	B	74.4/47.4
C521	4030018960	S.CER C3216 JB 1C 106MT-N	B	65.6/20.6
C522	4030016930	S.CER ECJ0EB1A104K	B	69.7/19.8
C523	4030018970	S.CER C3225 JB 1C 226MT-N	B	53.4/28.9
C524	4030017700	S.CER ECJ0EC1H151J	B	59/42.6
C525	4030016930	S.CER ECJ0EB1A104K	B	55.4/30.3
C526	4030018090	S.CER ECJ0EB1C822K	B	59.2/35.8
C527	4030018100	S.CER ECJ0EB1H681K	B	59/45.9
C528	4030017730	S.CER ECJ0EB1E471K	B	59/45
C529	4030018970	S.CER C3225 JB 1C 226MT-N	B	58.4/40
C530	4030016930	S.CER ECJ0EB1A104K	B	77.2/39.1
C531	4030018970	S.CER C3225 JB 1C 226MT-N	B	81.3/35.9
C532	4030016930	S.CER ECJ0EB1A104K	B	77.2/36.6
C533	4030017490	S.CER C1608 JB 1A 105K-T	B	77/44.5
C534	4030016970	S.CER ECJ0EB1C223K	B	77.5/42.5
C536	4610001850	S.TRI TZB4R200AB10R00 (TZBX4R200BA110)	B	81/39.7
C537	4030016930	S.CER ECJ0EB1A104K	B	77.2/40.1
C538	4030016930	S.CER ECJ0EB1A104K	B	77.2/37.6
C539	4030018910	S.CER C1608 JB 0J 475K-T	B	77.7/34.9
C540	4030018910	S.CER C1608 JB 0J 475K-T	B	58.5/37
C541	4030018970	S.CER C3225 JB 1C 226MT-N	B	59.2/28.9
C542	4030018910	S.CER C1608 JB 0J 475K-T	B	77.7/33.6
C543	4030018960	S.CER C3216 JB 1C 106MT-N	B	80/46.5
C544	4030018910	S.CER C1608 JB 0J 475K-T	B	77.7/32.3
C545	4030011600	S.CER C1608 JB 1E 104K-T	B	77/46.3
C549	4030018960	S.CER C3216 JB 1C 106MT-N	B	71.7/28.8
C550	4030018960	S.CER C3216 JB 1C 106MT-N	B	77/28.8
C551	4030018960	S.CER C3216 JB 1C 106MT-N	B	73.8/28.8
C559	4030017460	S.CER ECJ0EB1E102K	B	29.3/43.9
C560	4030018960	S.CER C3216 JB 1C 106MT-N	B	17/33.2
C561	4030017330	S.CER ECJ0EF1C104Z	B	7.3/30.7
C562	4030017780	S.CER ECJ0EB1E472K	B	6.1/30.9
C601	4030016930	S.CER ECJ0EB1A104K	B	73.6/24.9
C602	4030016930	S.CER ECJ0EB1A104K	B	48.8/43.5
C603	4030016930	S.CER ECJ0EB1A104K	B	55

[DISPLAY UNIT]

REF NO.	PARTS NO.	DESCRIPTION	M.	H/V LOCATION
C654	4030017490	S.CER C1608 JB 1A 105K-T	B	3.5/20.4
C655	4030016790	S.CER ECJ0EB1C103K	B	8.0/30.3
C656	4030019090	S.CER C2012 JB 1C 225M-T	B	7.8/25.5
C657	4030018520	S.CER C1608 JB 0J 225M-T	B	7/20.6
C658	4030017650	S.CER ECJ0EC1H270J	B	5.5/20.5
C659	4030017780	S.CER ECJ0EB1E472K	B	15.2/20.3
C701	4030018960	S.CER C3216 JB 1C 106MT-N	B	4.6/32.4
C702	4030018960	S.CER C3216 JB 1C 106MT-N	B	48.9/19
C801	4030016930	S.CER ECJ0EB1A104K	B	62.9/19.7
C802	4030011600	S.CER C1608 JB 1E 104K-T	B	21.5/48.5
C851	4030017780	S.CER ECJ0EB1E472K	B	32.1/23.9
C852	4030018960	S.CER C3216 JB 1C 106MT-N	B	40.3/15.8
C853	4030016930	S.CER ECJ0EB1A104K	B	43.1/27.5
C2001	4030018520	S.CER C1608 JB 0J 225M-T	B	78.5/16.7
C2002	4030017780	S.CER ECJ0EB1E472K	T	114.8/34.7
C2003	4030017630	S.CER ECJ0EC1H120J	B	103.3/28.7
C2004	4030017630	S.CER ECJ0EC1H120J	B	103.3/25.1
C2005	4030016790	S.CER ECJ0EB1C103K	B	103.2/34.9
C2006	4030016930	S.CER ECJ0EB1A104K	B	98/37.9
C2007	4030018960	S.CER C3216 JB 1C 106MT-N	B	105.8/47.7
C2008	4030017030	S.CER ECJ0EB1A273K	B	109.7/44.6
C2009	4030016930	S.CER ECJ0EB1A104K	B	99/37.9
C2010	4030016930	S.CER ECJ0EB1A104K	B	100/37.9
C2011	4030016930	S.CER ECJ0EB1A104K	B	78.7/29.9
C2012	4030017780	S.CER ECJ0EB1E472K	B	95.8/37.9
C2013	4030017780	S.CER ECJ0EB1E472K	T	93/37.9
C2014	4030016930	S.CER ECJ0EB1A104K	B	110.4/41.7
C2015	4030016930	S.CER ECJ0EB1A104K	B	103.1/35.8
C2016	4030016930	S.CER ECJ0EB1A104K	B	82.7/28.4
J202	6510023801	S.CON S4B-ZR-SM4A-TF(LF)(SN)	B	115.9/39.4
J251	6510025770	S.CON 03-935H0-72BKA	B	154.2/45.8
J303	6510021431	S.CON S8B-ZR-SM4A-TF(LF)(SN)	B	115.9/20.9
J401	6510024840	S.CON 52746-1070	B	21.3/26.3
J601	6510024780	S.CON 52437-2472	B	45.1/42
J2001	6510024790	S.CON 52559-1072	B	96.9/47.6
DS805	5040003190	S.LED NSSW008B	T	29.5/39.4
DS806	5040003190	S.LED NSSW008B	T	29.4/31.4
DS807	5040003190	S.LED NSSW008B	T	29.4/24.1
DS808	5040003190	S.LED NSSW008B	T	29.5/16.1
DS2001	5040002930	S.LED SML-512MW T86	T	110.2/15.8
DS2002	5040002020	S.LED CL-170UR-CD-T 0	T	110.2/36.8
DS2004	5040002930	S.LED SML-512MW T86	T	11.4/20.5
S201	2230001160	S.SWI SPVP110100	T	157.4/34.3
S251	2220000330	S.SWI HSW0880-01-210	B	139.7/46.5
S701	2230001150	S.SWI LS9J2M-1FG-T	T	22.2/48.3
S702	2230001150	S.SWI LS9J2M-1FG-T	T	21.7/36.5
S703	2230001150	S.SWI LS9J2M-1FG-T	T	20.9/17
S704	2230001150	S.SWI LS9J2M-1FG-T	T	21.6/2.7
S721	2230001150	S.SWI LS9J2M-1FG-T	T	40.1/2.4
S722	2230001150	S.SWI LS9J2M-1FG-T	T	54.3/2.4
S723	2230001150	S.SWI LS9J2M-1FG-T	T	68.4/2.4
S724	2230001150	S.SWI LS9J2M-1FG-T	T	82.6/2.4
S741	2230001150	S.SWI LS9J2M-1FG-T	T	98.1/47.8
S742	2230001150	S.SWI LS9J2M-1FG-T	T	99.1/32.1
S743	2230001150	S.SWI LS9J2M-1FG-T	T	99.1/20.5
S744	2230001150	S.SWI LS9J2M-1FG-T	T	98.1/5.7
S761	2230001150	S.SWI LS9J2M-1FG-T	T	109.5/49.1
S762	2230001150	S.SWI LS9J2M-1FG-T	T	109.5/3.5
S763	2230001150	S.SWI LS9J2M-1FG-T	T	154.8/47.4
S764	2230001150	S.SWI LS9J2M-1FG-T	T	154.8/5.1
S781	2230001150	S.SWI LS9J2M-1FG-T	T	4.6/29
S782	2230001150	S.SWI LS9J2M-1FG-T	T	21.7/25.8
EP1	6910014730	S.BEA MPZ2012S331A-T	B	64.1/6.6

[VR UNIT]

REF NO.	PARTS NO.	DESCRIPTION	M.	H/V LOCATION
R1	7210003230	VAR TP96D00A-17F-10K BX2-2427		
R2	7030003860	S.RES ERJ3GE JPW V	T	1.3/32.6
R3	7030003860	S.RES ERJ3GE JPW V	T	2.3/30
J1	6510024850	S.CON 54550-1094	T	3.3/22.2
S1	2250000170	ENC TP90D96AE20-17F (1352)		
EP4	6910012350	S.BEA MMZ1608Y 102BT	T	2.7/32.6
EP5	6910012350	S.BEA MMZ1608Y 102BT	T	3.7/30
EP6	6910012350	S.BEA MMZ1608Y 102BT	T	.9/30
EP7	6910012350	S.BEA MMZ1608Y 102BT	T	.9/14.5
EP8	6910012350	S.BEA MMZ1608Y 102BT	T	3.7/14.5
EP9	6910012350	S.BEA MMZ1608Y 102BT	T	2.7/11.8
EP10	6910012350	S.BEA MMZ1608Y 102BT	T	2.3/14.5
EP11	6910012350	S.BEA MMZ1608Y 102BT	T	1.3/11.8

M.=Mounted side (T: Mounted on the Top side, B: Mounted on the Bottom side)
S.=Surface mount

[LOGIC UNIT]

REF NO.	PARTS NO.	DESCRIPTION	M.	H/V LOCATION
IC1	1130013281	S.IC TC58FVM6T5BTG65GCH (SX2427D-6)	T	27.9/30.2
IC2	1130011151	S.IC SN74AHC2G08HDC3 0	B	40.2/38.2
IC3	1130011151	S.IC SN74AHC2G08HDC3 0	B	40.6/32.4
IC4	1130012600	S.IC SN74AHC1G04DCKR	B	43.6/33.8
IC51	1130012842	S.IC CY7C1021DV33-10BVXIT	B	24.5/28.5
IC301	1140012541	S.IC ADSP-BF532SBBBCZ400	B	28.6/39.2
IC401	1110004770	S.IC BU9480F-E2	B	17.4/21.6
IC451	1110006570	S.IC TS462CPT	B	29.1/7.9
IC452	1110006570	S.IC TS462CPT	T	39.1/8.5
IC502	1110006570	S.IC TS462CPT	T	30.7/5.4
IC551	1190001611	S.IC AK4528VFP-E2/P	T	17.9/8.1
IC601	1110006570	S.IC TS462CPT	B	12.7/10.8
IC701	1130012600	S.IC SN74AHC1G04DCKR	B	2.7/15.9
IC1201	1130012792	S.IC CY22150KFZXCT	B	44.5/4.5
IC1212	1140012170	S.IC BH7236AF-E2	T	57.7/7.3
IC1217	1130007181	S.IC TC7WU04FU(TE12L,F)	B	63.4/9.8
IC1218	1130012761	S.IC SN74AHC2G86HDC3 0	B	52.7/6.5
IC1226	1130010871	S.IC S1D13706F00A200	B	53.7/19.8
IC1251	1180002020	S.REG BA033FP-E2	T	79.5/5.2
IC1301	1130012691	S.IC R1EX24256ASA00A	T	81.4/36.2
IC1302	1140013137	S.IC HD6432375A23FQV(SX-2427B-7)	T	54.9/25.2
IC1303	1110005771	S.IC S-80942CNMC-G9C2G	T	81.2/10.4
IC1304	1130011551	S.IC RX-4581NB-F	B	71.9/7.2
IC1402	1130012781	S.IC SN74AHC2G04HDC3 0	T	79.1/18.9
IC2002	1130012842	S.IC CY7C1021DV33-10BVXIT	B	32.7/28.3
IC2101	1130012850	S.IC SN74LVC3G34DCUR	T	44.5/44.7
IC2102	1130012850	S.IC SN74LVC3G34DCUR	T	44.4/41.2
IC2201	1140012541	S.IC ADSP-BF532SBBBCZ400	B	28.6/17.7
Q201	1550000110	S.FET RTQ035P02TR	B	18.9/42.7
Q1101	1530002060	S.TRA 2SC4081 T106 R	T	82.1/20.3
Q1102	1590003940	S.TRA RN1105(TE85L,F)	T	81.8/22.7
Q1103	1510000510	S.TRA 2SA1576A T106R	T	81.8/16.4
Q1201	1590003940	S.TRA RN1105(TE85L,F)	T	44.8/13.2
D201	1750001280	S.DIO CUS02(TE85L,Q)	B	19.2/45.3
D1001	1750000370	S.DIO DA221 TL	B	64.5/36.8
D1002	1750000370	S.DIO DA221 TL	B	64.9/34.4
D1101	1790001250	S.DIO MA2S111-(TX)	T	81.9/18.5
D1106	1750000950	S.DIO MA732(TX)	T	80.1/29.6
D1107	1790001670	S.DIO RB706F-40T106	T	82.4/31.3
D1110	1790001670	S.DIO RB706F-40T106	T	75.7/32.3
D1111	1790001670	S.DIO RB706F-40T106	T	75.3/29.3
D1112	1790001670	S.DIO RB706F-40T106	B	79.2/29.1
D1113	1790001670	S.DIO RB706F-40T106	B	82.3/30.6
D1201	1790001250	S.DIO MA2S111-(TX)	B	83/40.4
D1301	1790000660	S.DIO MA728(TX)	B	77.5/2.9
D1304	1750000370	S.DIO DA221 TL	T	76.1/19.9
D1305	1750000370	S.DIO DA221 TL	T	75.8/16.8
D1306	1750000370	S.DIO DA221 TL	B	49.3/32.9
D1307	1750000370	S.DIO DA221 TL	B	51.4/33.3
D1311	1790001250	S.DIO MA2S111-(TX)	B	80.9/19.6
D1312	1790001250	S.DIO MA2S111-(TX)	B	83.1/18.5
D1313	1790001250	S.DIO MA2S111-(TX)	B	80/22.6
D1314	1790001240	S.DIO MA2S728-(TX)	B	81.7/22.4
D1331	1790001250	S.DIO MA2S111-(TX)	B	65.6/17.5
X1201	6050012150	S.XTA CR-806 SMD-49TA 4.433619 MHz [EUR]	B	61.3/3.1
	6050012150	S.XTA CR-806 SMD-49TA 4.433619 MHz [FRA]		
	6050012150	S.XTA CR-806 SMD-49TA 4.433619 MHz [ESP]		
	6050012140	S.XTA CR-805 SMD-49TA 3.579545 MHz [USA]		
	6050012150	S.XTA CR-806 SMD-49TA 4.433619 MHz [EXP]		
	6050012150	S.XTA CR-806 SMD-49TA 4.433619 MHz [ITR]		
	6050012150	S.XTA CR-806 SMD-49TA 4.433619 MHz [UK]		
	6050012140	S.XTA CR-805 SMD-49TA 3.579545 MHz [KOR]		
	6050012150	S.XTA CR-806 SMD-49TA 4.433619 MHz [AUS]		
	6050012150	S.XTA CR-806 SMD-49TA 4.433619 MHz [CHN]		
X1301	6050012190	S.XTA CR-809 SMD-49TA 1539744 MHz	B	60.4/30.8
L201	6200011900	S.COI LQH43CN100K03L	T	16/41.9
L202	6200009491	S.COI CDRH6D28NP-100NC	B	13.3/42.3
L551	6200005011	S.COI NLV25T-100J	T	11.2/10.5
L552	6200005011	S.COI NLV25T-100J	T	11.1/5.8
L1202	6200002041	S.COI NLV25T-101J	B	52.3/2.3
L1203	6200002041	S.COI NLV25T-101J	T	66.7/3.5
L1204	6200002041	S.COI NLV25T-101J	B	57.9/10.3
L2101	6200005011	S.COI NLV25T-100J	T	40.9/4.5
L2102	6200005011	S.COI NLV25T-100J	T	40.2/41.5
R2	7030005090	S.RES ERJ2GEJ 104 X (100K)	T	39.5/30.1
R3	7030005090	S.RES ERJ2GEJ 104 X (100K)	T	39.5/32.4
R4	7030005090	S.RES ERJ2GEJ 104 X (100K)	T	31.8/45.8
R5	7030005090	S.RES ERJ2GEJ 104 X (100K)	T	30.9/45.8

[LOGIC UNIT]

REF NO.	PARTS NO.	DESCRIPTION	M.	H/V LOCATION
R6	7030005090	S.RES ERJ2GEJ 104 X (100K)	T	30/45.8
R203	7030000010	S.RES MCR10EZHJ JPW (000)	T	20.7/45.6
R301	7030004980	S.RES ERJ2GEJ 101 X (100)	T	25.4/45.8
R302	7030005050	S.RES ERJ2GEJ 103 X (10K)	T	26.9/45.8
R303	7030005050	S.RES ERJ2GEJ 103 X (10K)	T	27.8/45.8
R306	7030005050	S.RES ERJ2GEJ 103 X (10K)	B	38.1/31.1
R307	7030005050	S.RES ERJ2GEJ 103 X (10K)	T	22/41.4
R308	7030005050	S.RES ERJ2GEJ 103 X (10K)	T	22/40.5
R310	7030005050	S.RES ERJ2GEJ 103 X (10K)	B	35.3/38
R312	7030010040	S.RES ERJ2GEJ-JPW	B	33.6/45.9
R313	7030010040	S.RES ERJ2GEJ-JPW	B	35.6/43.3
R314	7030010040	S.RES ERJ2GEJ-JPW	B	35.6/40.6
R413	7030004980	S.RES ERJ2GEJ 101 X (100)	B	18.1/16.8
R414	7030004980	S.RES ERJ2GEJ 101 X (100)	T	16.3/19.9
R415	7030004980	S.RES ERJ2GEJ 101 X (100)	B	19/16.8
R416	7030004980	S.RES ERJ2GEJ 101 X (100)	B	17.2/16.8
R462	7030004980	S.RES ERJ2GEJ 101 X (100)	B	33.8/7.4
R463	7030004980	S.RES ERJ2GEJ 101 X (100)	T	43.6/8.8
R464	7030004980	S.RES ERJ2GEJ 101 X (100)	B	26.2/57.2
R465	7030009270	S.RES ERJ2GEJ 821 X (820)	B	28.6/5.2
R467	7030004980	S.RES ERJ2GEJ 101 X (100)	B	31.3/4.3
R469	7030009270	S.RES ERJ2GEJ 821 X (820)	B	30.4/4.3
R470	7030009140	S.RES ERJ2GEJ 272 X (2.7K)	T	29.4/3
R471	7030009140	S.RES ERJ2GEJ 272 X (2.7K)	T	34/3.3
R472	7030005040	S.RES ERJ2GEJ 472 X (4.7K)	T	38.6/4.2
R473	7030005040	S.RES ERJ2GEJ 472 X (4.7K)	T	38.6/3.2
R474	7030009140	S.RES ERJ2GEJ 272 X (2.7K)	B	24.8/7.1
R475	7030009140	S.RES ERJ2GEJ 272 X (2.7K)	B	33.8/9.2
R476	7030005040	S.RES ERJ2GEJ 472 X (4.7K)	T	40.2/3.3
R507	7030004980	S.RES ERJ2GEJ 101 X (100)	T	26/3.5
R508	7030004980	S.RES ERJ2GEJ 101 X (100)	T	31.6/8.9
R510	7030005040	S.RES ERJ2GEJ 472 X (4.7K)	T	32.5/8.9
R511	7030005040	S.RES ERJ2GEJ 472 X (4.7K)	T	28.9/8.9
R512	7030004980	S.RES ERJ2GEJ 101 X (100)	T	29.8/8.9
R514	7030005050	S.RES ERJ2GEJ 103 X (10K)	T	34.9/8.8
R515	7030005050	S.RES ERJ2GEJ 103 X (10K)	T	34.9/7.9
R516	7030005040	S.RES ERJ2GEJ 472 X (4.7K)	T	39/12.8
R517	7030005040	S.RES ERJ2GEJ 472 X (4.7K)	T	36.5/11
R518	7030009140	S.RES ERJ2GEJ 272 X (2.7K)	T	36.4/5.6
R519	7030009140	S.RES ERJ2GEJ 272 X (2.7K)	T	26.4/5.6
R520	7030005040	S.RES ERJ2GEJ 472 X (4.7K)	T	41.3/12.8
R551	7030004980	S.RES ERJ2GEJ 101 X (100)	T	16.5/13.4
R553	7030004980	S.RES ERJ2GEJ 101 X (100)	T	14.7/13.4
R554	7030005090	S.RES ERJ2GEJ 104 X (100K)	T	15.4/3.2
R568	7030004980	S.RES ERJ2GEJ 101 X (100)	T	12.9/13.4
R569	7030004980	S.RES ERJ2GEJ 101 X (100)	T	15.6/13.4
R570	7030004980	S.RES ERJ2GEJ 101 X (100)	T	13.8/13.4
R571	7030009320	S.RES ERJ2GEJ 4R7 X (4.7)	B	20.7/8.4
R601	7030004980	S.RES ERJ2GEJ 101 X (100)	T	3/12.3
R602	7030007300	S.RES ERJ2GEJ 332 X (3.3K)	T	11.8/8.4
R603	7030005040	S.RES ERJ2GEJ 472 X (4.7K)	B	12.3/4.8
R604	7030005040	S.RES ERJ2GEJ 472 X (4.7K)	B	13.2/4.8
R605	7030007300	S.RES ERJ2GEJ 332 X (3.3K)	B	14.4/5.1
R606	7030007300	S.RES ERJ2GEJ 332 X (3.3K)	B	12.8/7.2
R607	7030005290	S.RES ERJ2GEJ 682 X (6.8K)	B	13.8/7.2
R608	7030005290	S.RES ERJ2GEJ 682 X (6.8K)	B	14.8/6.4
R609	7030005040	S.RES ERJ2GEJ 472 X (4.7K)	T	10.9/8.4
R610	7030005040	S.RES ERJ2GEJ 472 X (4.7K)	B	8.9/4.2
R611	7030005040	S.RES ERJ2GEJ 472 X (4.7K)	B	9.8/4.2
R612	7030007300	S.RES ERJ2GEJ 332 X (3.3K)	B	11.4/5.6
R613	7030007300	S.RES ERJ2GEJ 332 X (3.3K)	B	8.8/6.9
R614	7030005290	S.RES ERJ2GEJ 682 X (6.8K)	B	9.7/6.9
R615	7030005290	S.RES ERJ2GEJ 682 X (6.8K)	B	10.6/6.9
R618	7030005120	S.RES ERJ2GEJ 102 X (1K)	B	14.4/4.2
R619	7030005120	S.RES ERJ2GEJ 102 X (1K)	B	10.7/4.2
R701	7030005050	S.RES ERJ2GEJ 103 X (10K)	B	4.6/22.8
R702	7030005050	S.RES ERJ2GEJ 103 X (10K)	B	4.6/23.7
R703	7030005050	S.RES ERJ2GEJ 103 X (10K)	B	4.5/25.9
R705	7030005120	S.RES ERJ2GEJ 102 X (1K)	B	5/21
R706	7030005050	S.RES ERJ2GEJ 103 X (10K)	B	4.4/17.1
R707	7030007250	S.RES ERJ2GEJ 220 X (22)	B	4.4/15.5
R1001	7030005120	S.RES ERJ2GEJ 102 X (1K)	B	70.8/37
R1002	7030005050	S.RES ERJ2GEJ 103 X (10K)	B	65.9/32.3
R1003	7030005160	S.RES ERJ2GEJ 105 X (1M)	B	70.4/35.8
R1004	7030005240	S.RES ERJ2GEJ 473 X (47K)	B	66.1/18.5
R1006	7030005120	S.RES ERJ2GEJ 102 X (1K)	B	52/34.8
R1007	7030005120	S.RES ERJ2GEJ 102 X (1K)	B	53.2/32
R1008	7030005120	S.RES ERJ2GEJ 102 X (1K)	B	75.1/20.4
R1010	7030005240	S.RES ERJ2GEJ 473 X (47K)	B	76.7/19.8
R1012	7030005000	S.RES ERJ2GEJ 471 X (470)	B	66.5/33.9
R1013	7030005000	S.RES ERJ2GEJ 471 X (470)	B	66.5/36.4
R1015	7030005240	S.RES ERJ2GEJ 473 X (47K)	B	50.4/34.8
R1016	7030005240	S.RES ERJ2GEJ 473 X (47K)	B	51/31.7
R1018	7030007340	S.RES ERJ2GEJ 153 X (15K)	B	63.3/34.4
R1019	7030007340	S.RES ERJ2GEJ 153 X (15K)	B	62.9/36.1
R1101	7030008290	S.RES ERJ2GEJ 183 X (18K)	T	80.1/15.4
R1102	7030008010	S.RES ERJ2GEJ 123 X (12K)	T	79.9/21.9
R1103	7030005120	S.RES ERJ2GEJ 102 X (1K)	T	79.9/22.8
R1104	7030005120	S.RES ERJ2		

[LOGIC UNIT]

REF NO.	PARTS NO.	DESCRIPTION	M.	H/V LOCATION
R1116	7030005120	S.RES ERJ2GEJ 102 X (1K)	T	76.9/28.1
R1117	7030005120	S.RES ERJ2GEJ 102 X (1K)	B	82.7/22.2
R1118	7030007300	S.RES ERJ2GEJ 332 X (3.3K)	B	83/23.8
R1119	7030007300	S.RES ERJ2GEJ 332 X (3.3K)	B	83.8/22.2
R1120	7030005120	S.RES ERJ2GEJ 102 X (1K)	B	84.1/23.8
R1123	7030005160	S.RES ERJ2GEJ 105 X (1M)	B	66.9/24.4
R1124	7030005120	S.RES ERJ2GEJ 102 X (1K)	B	82/20
R1126	7030005160	S.RES ERJ2GEJ 105 X (1M)	B	66.9/23.5
R1127	7030010040	S.RES ERJ2GEJ-JPW	T	73.7/18.5
R1128	7030005120	S.RES ERJ2GEJ 102 X (1K)	B	83.2/20.1
R1129	7030007300	S.RES ERJ2GEJ 332 X (3.3K)	B	81.9/28.4
R1131	7030005090	S.RES ERJ2GEJ 104 X (100K)	B	78.5/26.1
R1132	7030005090	S.RES ERJ2GEJ 104 X (100K)	B	81.4/24.4
R1201	7030005160	S.RES ERJ2GEJ 105 X (1M)	B	62.7/7.6
R1202	7030005050	S.RES ERJ2GEJ 103 X (10K)	B	49.2/7.5
R1203	7030005050	S.RES ERJ2GEJ 103 X (10K)	B	49.2/8.4
R1204	7030005050	S.RES ERJ2GEJ 103 X (10K)	B	49.7/9.6
R1205	7030010040	S.RES ERJ2GEJ-JPW	B	49.2/3.1
R1206	7030007570	S.RES ERJ2GEJ 122 X (1.2K)	B	46.1/9.6
R1207	7030007570	S.RES ERJ2GEJ 122 X (1.2K)	B	43.9/9.6
R1208	7030007570	S.RES ERJ2GEJ 122 X (1.2K)	B	43.5/11.4
R1209	7030009710	S.RES ERJ2GEJ 203 X (20K)	B	48.8/9.6
R1210	7030007350	S.RES ERJ2GEJ 393 X (39K)	B	47.9/9.6
R1211	7030005050	S.RES ERJ2GEJ 103 X (10K)	B	48.9/11.4
R1212	7030005050	S.RES ERJ2GEJ 103 X (10K)	B	48/11.4
R1213	7030005050	S.RES ERJ2GEJ 103 X (10K)	B	47.1/11.4
R1214	7030009710	S.RES ERJ2GEJ 203 X (20K)	B	46.2/11.4
R1215	7030007350	S.RES ERJ2GEJ 393 X (39K)	B	45.3/11.4
R1216	7030005050	S.RES ERJ2GEJ 103 X (10K)	B	44.7/12.6
R1217	7030005050	S.RES ERJ2GEJ 103 X (10K)	B	44.7/13.5
R1218	7030005050	S.RES ERJ2GEJ 103 X (10K)	B	44.7/14.4
R1219	7030005040	S.RES ERJ2GEJ 472 X (4.7K)	B	74.4/41.1
R1220	7030009710	S.RES ERJ2GEJ 203 X (20K)	B	44.7/15.3
R1221	7030005040	S.RES ERJ2GEJ 472 X (4.7K)	B	82.9/41.6
R1222	7030005040	S.RES ERJ2GEJ 472 X (4.7K)	B	74.4/40.2
R1223	7030005040	S.RES ERJ2GEJ 472 X (4.7K)	B	74.4/39.3
R1224	7030005040	S.RES ERJ2GEJ 472 X (4.7K)	B	82.9/39.3
R1225	7030005240	S.RES ERJ2GEJ 473 X (47K)	B	83.1/35.7
R1226	7030005240	S.RES ERJ2GEJ 473 X (47K)	B	74.4/37.5
R1227	7030005240	S.RES ERJ2GEJ 473 X (47K)	B	73.8/38.4
R1228	7030005240	S.RES ERJ2GEJ 473 X (47K)	B	82.2/35.7
R1229	7030007350	S.RES ERJ2GEJ 393 X (39K)	B	43.5/15.4
R1230	7030004970	S.RES ERJ2GEJ 470 X (47)	B	49.2/2.2
R1231	7030005050	S.RES ERJ2GEJ 103 X (10K)	B	48.8/5.4
R1232	7030005220	S.RES ERJ2GEJ 223 X (22K)	B	40.3/3.2
R1235	7030007270	S.RES ERJ2GEJ 151 X (150)	T	66.2/5.9
R1236	7030007270	S.RES ERJ2GEJ 151 X (150)	T	66.2/7
R1237	7030007290	S.RES ERJ2GEJ 222 X (2.2K)	B	61.1/7.6
R1251	7030011250	S.RES ERJ1TY 390U (39)	T	70.3/6.4
R1301	7030005220	S.RES ERJ2GEJ 223 X (22K)	T	78.1/37.8
R1302	7030005050	S.RES ERJ2GEJ 103 X (10K)	T	78.1/36
R1303	7030005240	S.RES ERJ2GEJ 473 X (47K)	B	66/21.2
R1304	7030005240	S.RES ERJ2GEJ 473 X (47K)	B	66/20.3
R1305	7030009160	S.RES ERJ2GEJ 181 X (180)	T	68.5/25.9
R1306	7030005060	S.RES ERJ2GEJ 333 X (33K)	T	78.7/11.4
R1307	7030005040	S.RES ERJ2GEJ 472 X (4.7K)	T	68/21.9
R1308	7030005110	S.RES ERJ2GEJ 224 X (220K)	T	67.5/20
R1309	7030005110	S.RES ERJ2GEJ 224 X (220K)	T	69/19.4
R1310	7030005110	S.RES ERJ2GEJ 224 X (220K)	T	67.5/18.8
R1311	7030005110	S.RES ERJ2GEJ 224 X (220K)	T	69/18.2
R1312	7030005110	S.RES ERJ2GEJ 224 X (220K)	T	67.5/17.6
R1313	7030005110	S.RES ERJ2GEJ 224 X (220K)	T	69/17
R1314	7030005110	S.RES ERJ2GEJ 224 X (220K)	T	67.5/16.4
R1315	7030005110	S.RES ERJ2GEJ 224 X (220K)	T	69/15.8
R1316	7030005110	S.RES ERJ2GEJ 224 X (220K)	B	66.6/12.3
R1317	7030005110	S.RES ERJ2GEJ 224 X (220K)	B	65.7/12.3
R1318	7030005110	S.RES ERJ2GEJ 224 X (220K)	B	64.8/12.3
R1319	7030005110	S.RES ERJ2GEJ 224 X (220K)	B	63.9/12.3
R1320	7030005110	S.RES ERJ2GEJ 224 X (220K)	B	63/12.3
R1321	7030005110	S.RES ERJ2GEJ 224 X (220K)	B	62.1/12.3
R1322	7030005110	S.RES ERJ2GEJ 224 X (220K)	B	61.2/12.3
R1323	7030005110	S.RES ERJ2GEJ 224 X (220K)	B	60.3/12.1
R1324	7030005050	S.RES ERJ2GEJ 103 X (10K)	T	80.5/12.6
R1325	7030007350	S.RES ERJ2GEJ 393 X (39K)	T	78.1/9.8
R1326	7030005010	S.RES ERJ2GEJ 681 X (680)	B	78.9/2
R1327	7030005240	S.RES ERJ2GEJ 473 X (47K)	B	66/19.4
R1328	7030005050	S.RES ERJ2GEJ 103 X (10K)	B	75.9/6.4
R1329	7030005240	S.RES ERJ2GEJ 473 X (47K)	B	75.9/5
R1331	7030010040	S.RES ERJ2GEJ-JPW	B	75.9/3.2
R1332	7030005040	S.RES ERJ2GEJ 472 X (4.7K)	B	75.9/4.1
R1333	7030005110	S.RES ERJ2GEJ 224 X (220K)	T	67.4/26.9
R1334	7030005050	S.RES ERJ2GEJ 103 X (10K)	T	78.3/12.6
R1335	7030010040	S.RES ERJ2GEJ-JPW	B	78.5/5.1
R1337	7030005240	S.RES ERJ2GEJ 473 X (47K)	T	40.9/15.5
R1338	7030005240	S.RES ERJ2GEJ 473 X (47K)	T	40.9/16.4
R1339	7030007290	S.RES ERJ2GEJ 222 X (2.2K)	B	65.5/22.4
R1401	7030005240	S.RES ERJ2GEJ 473 X (47K)	B	62.7/24.2
R1402	7030005240	S.RES ERJ2GEJ 473 X (47K)	B	76.7/21.8
R1403	7030005240	S.RES ERJ2GEJ 473 X (47K)	B	78.3/22.1
R1404	7030005240	S.RES ERJ2GEJ 473 X (47K)	B	76.7/22.9
R1405	7030005240	S.RES ERJ2GEJ 473 X (47K)	T	50.7/12.9
R1406	7030005240	S.RES ERJ2GEJ 473 X (47K)	T	69/20.6
R1407	7030005240	S.RES ERJ2GEJ 473 X (47K)	T	41.7/33.4
R1408	7030005240	S.RES ERJ2GEJ 473 X (47K)	B	76.7/25.3
R1409	7030005240	S.RES ERJ2GEJ 473 X (47K)	B	78.3/24.7
R1410	7030005240	S.RES ERJ2GEJ 473 X (47K)	B	78.3/23.5
R1411	7030005240	S.RES ERJ2GEJ 473 X (47K)	B	76.7/24.1
R1412	7030005240	S.RES ERJ2GEJ 473 X (47K)	B	43.6/24.7
R1413	7030005240	S.RES ERJ2GEJ 473 X (47K)	T	42.4/17.9

[LOGIC UNIT]

REF NO.	PARTS NO.	DESCRIPTION	M.	H/V LOCATION
R1502	7030007300	S.RES ERJ2GEJ 332 X (3.3K)	B	80.9/28.4
R2101	7030005050	S.RES ERJ2GEJ 103 X (10K)	T	48.1/44.9
R2102	7030005050	S.RES ERJ2GEJ 103 X (10K)	T	47.7/42.7
R2103	7030005050	S.RES ERJ2GEJ 103 X (10K)	T	47.6/40.5
R2104	7030005050	S.RES ERJ2GEJ 103 X (10K)	T	47.7/43.7
R2105	7030005050	S.RES ERJ2GEJ 103 X (10K)	T	47.5/41.7
R2110	7030010040	S.RES ERJ2GEJ-JPW	B	21.4/22.5
R2112	7030005040	S.RES ERJ2GEJ 472 X (4.7K)	T	38.5/44.4
R2201	7030004980	S.RES ERJ2GEJ 101 X (100)	T	31.5/11.1
R2202	7030005050	S.RES ERJ2GEJ 103 X (10K)	T	30.6/11.1
R2203	7030005050	S.RES ERJ2GEJ 103 X (10K)	T	21.5/22.4
R2204	7030005050	S.RES ERJ2GEJ 103 X (10K)	T	35.2/15.5
R2205	7030005050	S.RES ERJ2GEJ 103 X (10K)	T	35.2/16.4
R2206	7030005050	S.RES ERJ2GEJ 103 X (10K)	T	21.5/21.5
R2214	7030005050	S.RES ERJ2GEJ 103 X (10K)	T	27.5/11.1
R2215	7030005050	S.RES ERJ2GEJ 103 X (10K)	T	28.4/11.1
R2216	7030010040	S.RES ERJ2GEJ-JPW	T	34.8/37.3
C1	4030016930	S.CER ECJ0EB1A104K	T	16.9/25.1
C2	4030016930	S.CER ECJ0EB1A104K	B	38.1/36
C3	4030016930	S.CER ECJ0EB1A104K	B	39.5/28.9
C4	4030016930	S.CER ECJ0EB1A104K	B	42.4/35.8
C5	4550007310	S.TAN F930J227MNMBSMA	T	40.8/23.1
C51	4030016930	S.CER ECJ0EB1A104K	B	19.2/27.4
C52	4030016930	S.CER ECJ0EB1A104K	B	19.2/28.3
C53	4550007310	S.TAN F930J227MNMBSMA	B	11.4/30.3
C54	4550007310	S.TAN F930J227MNMBSMA	T	7.1/8
C201	4030016930	S.CER ECJ0EB1A104K	B	19/40.2
C203	4030018960	S.CER C3216 JB 1C 106MT-N	T	18.8/45.5
C204	4030016930	S.CER ECJ0EB1A104K	T	11.9/40.2
C205	4030016930	S.CER ECJ0EB1A104K	T	11.9/41.8
C206	4030016930	S.CER ECJ0EB1A104K	B	8.8/43.4
C207	4030019460	S.CER C1608 JB 0J 106M-T	T	9.9/45
C202	4030016930	S.CER ECJ0EB1A104K	T	30.2/40.4
C303	4030016930	S.CER ECJ0EB1A104K	T	30.4/37.8
C304	4030016930	S.CER ECJ0EB1A104K	T	26.9/37.2
C305	4030016930	S.CER ECJ0EB1A104K	T	34.1/45.8
C306	4030016930	S.CER ECJ0EB1A104K	T	29.2/37.2
C307	4030016930	S.CER ECJ0EB1A104K	B	38.3/35
C308	4030016930	S.CER ECJ0EB1A104K	T	27.3/39.3
C309	4030016930	S.CER ECJ0EB1A104K	T	30.6/39.1
C310	4030016930	S.CER ECJ0EB1A104K	T	24.5/45.8
C311	4030016930	S.CER ECJ0EB1A104K	T	22/42.3
C312	4030016930	S.CER ECJ0EB1A104K	T	27.8/40.5
C313	4030016930	S.CER ECJ0EB1A104K	T	22/39.6
C314	4030016930	S.CER ECJ0EB1A104K	T	29.1/45.8
C315	4030016930	S.CER ECJ0EB1A104K	T	27.3/38.4
C316	4030016930	S.CER ECJ0EB1A104K	T	30.4/36.9
C317	4030016930	S.CER ECJ0EB1A104K	T	26.9/40.5
C318	4030016930	S.CER ECJ0EB1A104K	T	31.1/40.4
C319	4030016930	S.CER ECJ0EB1A104K	T	29.3/40.4
C320	4030016930	S.CER ECJ0EB1A104K	T	27.8/37.2
C413	4030018960	S.CER C3216 JB 1C 106MT-N	B	21.3/19.6
C414	4030016930	S.CER ECJ0EB1A104K	B	16.3/16.8
C415	4030018960	S.CER C3216 JB 1C 106MT-N	B	15.6/26.3
C461	4030016930	S.CER ECJ0EB1A104K	B	34.2/4.3
C462	4030018960	S.CER C3216 JB 1C 106MT-N	B	35.3/5.8
C463	4030018960	S.CER C3216 JB 1C 106MT-N	T	42/8.7
C464	4030016930	S.CER ECJ0EB1A104K	T	43.6/10.4
C465	4030017740	S.CER ECJ0EB1E821K	B	27.4/5.5
C466	4030017760	S.CER ECJ0EB1H222K	B	29.5/4.3
C467	4030017740	S.CER ECJ0EB1E821K	B	30.7/5.5
C468	4030018560	S.CER C2012 JB 1A 475K-T	T	31.8/2.6
C469	4030016930	S.CER ECJ0EB1A104K	B	24.8/8.7
C470	4030016930	S.CER ECJ0EB1A104K	B	33.8/8.3
C471	4030018560	S.CER C2012 JB 1A 475K-T	T	36.2/4.2
C472	4030018560	S.CER C2012 JB 1A 475K-T	T	36.2/5.5
C473	4030016930	S.CER ECJ0EB1A104K	T	40.2/4.2
C509	4030018960	S.CER C3216 JB 1C 106MT-N	T	24.2/5.5
C510	4030016930	S.CER ECJ0EB1A104K	T	26/4.4
C511	4030017760	S.CER ECJ0EB1H222K	T	30.7/8.9
C512	4030017690	S.CER ECJ0EC1H121J	T	32.1/7.7
C513	4030017690	S.CER ECJ0EC1H121J	T	29.4/7.7
C514	4030016930	S.CER ECJ0EB1A104K	T	36.4/5.5
C515	4030018860	S.CER ECJ0EB0J105K	T	36.5/9.2
C516	4030018860	S.CER ECJ0EB0J105K	T	36.5/8.3
C517	4030018860	S.CER ECJ0EB0J105K	T	36.5/10.1
C518	4030016930	S.CER ECJ0EB1A104K	T	26.1/6.8
C519	4030016930	S.CER ECJ0EB1A104K	T	41.3/11.9
C522	4030017780	S.CER ECJ0EB1E472K	B	38.9/9.8
C523	4030017780	S.CER ECJ0EB1E472K	B	38/2.8
C524	4030017780	S.CER ECJ0EB1E472K	T	3.8/2.6
C525	4030017780	S.CER ECJ0EB1E472K	T	22.4/2.7
C526	4030017780	S.CER ECJ0EB1E472K	T	42.9/3.8
C527	4030017780	S.CER ECJ0EB1E472K	B	2

[LOGIC UNIT]

REF NO.	PARTS NO.	DESCRIPTION	M.	H/V LOCATION
C606	4030018580	S.CER C1608 CH 1H 821J-T	B	9.6/5.6
C607	4030017440	S.CER ECJ0EC1H221J	B	13.3/8.4
C608	4030017440	S.CER ECJ0EC1H221J	B	14.8/8
C609	4030018860	S.CER ECJ0EB0J105K	B	15.8/14.5
C610	4030010760	S.CER C1608 CH 1H 331J-T	B	9.6/8.3
C611	4030010760	S.CER C1608 CH 1H 331J-T	B	11.8/7.7
C612	4030018960	S.CER C3216 JB 1C 106MT-N	B	7.5/13.1
C613	4550006780	S.TAN TEESVB2 0J 476M8R	B	20.6/2.7
C614	4550006780	S.TAN TEESVB2 0J 476M8R	T	3.1/6.6
C651	4030017460	S.CER ECJ0EB1E102K	B	65.5/31.4
C652	4030017460	S.CER ECJ0EB1E102K	B	66/16.4
C653	4030017460	S.CER ECJ0EB1E102K	B	77.1/20.9
C654	4030017430	S.CER ECJ0EC1H101J	B	77.2/28.2
C655	4030017430	S.CER ECJ0EC1H101J	B	76.5/27.1
C656	4030017430	S.CER ECJ0EC1H101J	B	76.1/26.2
C701	4030016930	S.CER ECJ0EB1A104K	B	3/13.5
C702	4030017780	S.CER ECJ0EB1E472K	B	4.4/18.8
C703	4030017780	S.CER ECJ0EB1E472K	B	7.5/26.1
C704	4030017780	S.CER ECJ0EB1E472K	B	19.7/26.2
C705	4030017430	S.CER ECJ0EC1H101J	B	4.6/21.9
C706	4030017430	S.CER ECJ0EC1H101J	B	4.6/24.6
C707	4030017430	S.CER ECJ0EC1H101J	B	3.9/27.2
C708	4030017430	S.CER ECJ0EC1H101J	B	6.6/26.1
C709	4030017430	S.CER ECJ0EC1H101J	T	2.5/20.1
C711	4550007310	S.TAN F930J227MNMBA	T	5.5/18.9
C715	4030017460	S.CER ECJ0EB1E102K	T	2.2/17.6
C716	4030017460	S.CER ECJ0EB1E102K	T	2.2/18.6
C717	4030017460	S.CER ECJ0EB1E102K	T	2.2/16.6
C1001	4030017780	S.CER ECJ0EB1E472K	B	76.7/18.9
C1002	4030017780	S.CER ECJ0EB1E472K	B	70.4/38.2
C1101	4030017780	S.CER ECJ0EB1E472K	T	79.9/23.7
C1102	4030017780	S.CER ECJ0EB1E472K	T	73.6/20.7
C1103	4030016930	S.CER ECJ0EB1A104K	T	81.8/14.5
C1106	4030017780	S.CER ECJ0EB1E472K	T	79.7/31.9
C1107	4030018900	S.CER ECJ0EB0J474K	B	80.1/25.5
C1108	4030018900	S.CER ECJ0EB0J474K	B	81.4/25.4
C1109	4030017780	S.CER ECJ0EB1E472K	T	79.7/26.3
C1110	4030017780	S.CER ECJ0EB1E472K	T	80.7/26.3
C1111	4030017780	S.CER ECJ0EB1E472K	T	81.7/26.3
C1112	4030017780	S.CER ECJ0EB1E472K	B	82.9/28.4
C1201	4030016930	S.CER ECJ0EB1A104K	B	50.6/4.3
C1202	4030017780	S.CER ECJ0EB1E472K	B	53.2/4.3
C1203	4030017650	S.CER ECJ0EC1H270J	B	62.7/6.7
C1204	4030016930	S.CER ECJ0EB1A104K	B	47.9/8
C1205	4030016930	S.CER ECJ0EB1A104K	B	45.2/9.6
C1206	4030016930	S.CER ECJ0EB1A104K	B	43.5/13.8
C1207	4030017430	S.CER ECJ0EC1H101J	B	47/9.6
C1208	4030017430	S.CER ECJ0EC1H101J	B	43.9/8.7
C1209	4030017430	S.CER ECJ0EC1H101J	B	44.4/11.4
C1210	4030017650	S.CER ECJ0EC1H270J	B	61.1/6.7
C1211	4030018860	S.CER ECJ0EB0J105K	B	60.2/10.5
C1212	4030016930	S.CER ECJ0EB1A104K	B	49.7/4.3
C1213	4030016930	S.CER ECJ0EB1A104K	B	49.2/6.6
C1214	4030016930	S.CER ECJ0EB1A104K	B	40.3/4.8
C1215	4030016930	S.CER ECJ0EB1A104K	B	64.2/19.3
C1216	4030016930	S.CER ECJ0EB1A104K	B	53.7/30.3
C1217	4030016930	S.CER ECJ0EB1A104K	B	57.5/29.2
C1218	4030016930	S.CER ECJ0EB1A104K	B	44.8/23.9
C1219	4030016930	S.CER ECJ0EB1A104K	B	46.3/13.2
C1220	4030016930	S.CER ECJ0EB1A104K	B	56/8.8
C1221	4030016930	S.CER ECJ0EB1A104K	B	60.5/13.7
C1222	4030016930	S.CER ECJ0EB1A104K	B	60.9/25.6
C1223	4030016930	S.CER ECJ0EB1A104K	T	52.7/12.3
C1225	4030018960	S.CER C3216 JB 1C 106MT-N	T	66.7/10.2
C1251	4030012610	S.CER C2012 JB 1C 474K-T	T	73.4/9.3
C1252	4550007320	S.TAN F930J226MAABMA	T	73.4/4.4
C1301	4030016930	S.CER ECJ0EB1A104K	T	80.1/40.3
C1302	4030018960	S.CER C3216 JB 1C 106MT-N	T	47.9/11.4
C1303	4030016790	S.CER ECJ0EB1C103K	T	67.9/30.4
C1304	4030016930	S.CER ECJ0EB1A104K	T	41.7/31.5
C1305	4030018960	S.CER C3216 JB 1C 106MT-N	T	44.3/37.2
C1306	4030016790	S.CER ECJ0EB1C103K	T	64/37.5
C1307	4030016930	S.CER ECJ0EB1A104K	T	48.4/12.9
C1308	4030016930	S.CER ECJ0EB1A104K	T	63.1/13.1
C1309	4030016930	S.CER ECJ0EB1A104K	T	46.1/37.2
C1310	4030016930	S.CER ECJ0EB1A104K	T	67/30.9
C1311	4030016930	S.CER ECJ0EB1A104K	T	67/25.7
C1312	4030017620	S.CER ECJ0EC1H100C	T	67.4/29.1
C1313	4030017620	S.CER ECJ0EC1H100C	T	67.4/28.2
C1314	4030016930	S.CER ECJ0EB1A104K	T	79/9.8
C1315	4030017030	S.CER ECJ0EB1A273K	T	83.3/10.8
C1316	4030016930	S.CER ECJ0EB1A104K	B	75.9/2.3
C1317	4030018960	S.CER C3216 JB 1C 106MT-N	B	84.4/3
C1319	4030018960	S.CER C3216 JB 1C 106MT-N	B	16.8/6.6
C2016	4030016930	S.CER ECJ0EB1A104K	B	37.7/29.3
C2017	4030016930	S.CER ECJ0EB1A104K	B	37.7/30.2
C2101	4030016930	S.CER ECJ0EB1A104K	T	44/43
C2102	4030016930	S.CER ECJ0EB1A104K	T	45.8/43
C2202	4030016930	S.CER ECJ0EB1A104K	T	27/16.5
C2204	4030016930	S.CER ECJ0EB1A104K	T	26.5/19.2
C2205	4030016930	S.CER ECJ0EB1A104K	T	30.2/19.7
C2206	4030016930	S.CER ECJ0EB1A104K	T	26.6/11.1
C2207	4030016930	S.CER ECJ0EB1A104K	T	27.7/19.7
C2208	4030016930	S.CER ECJ0EB1A104K	T	21.5/23.4
C2209	4030016930	S.CER ECJ0EB1A104K	T	29.8/17.6
C2210	4030016930	S.CER ECJ0EB1A104K	T	26.6/17.8
C2211	4030016930	S.CER ECJ0EB1A104K	T	32.4/11.1
C2212	4030016930	S.CER ECJ0EB1A104K	T	35.2/14.6
C2213	4030016930	S.CER ECJ0EB1A104K	T	29.3/16.4

[LOGIC UNIT]

REF NO.	PARTS NO.	DESCRIPTION	M.	H/V LOCATION
C2214	4030016930	S.CER ECJ0EB1A104K	T	35.2/17.3
C2215	4030016930	S.CER ECJ0EB1A104K	T	29.3/11.1
C2217	4030016930	S.CER ECJ0EB1A104K	T	29.8/18.5
C2218	4030016930	S.CER ECJ0EB1A104K	T	26.5/20.1
C2219	4030016930	S.CER ECJ0EB1A104K	T	30.2/16.4
C2220	4030016930	S.CER ECJ0EB1A104K	T	26.1/16.5
C2221	4030016930	S.CER ECJ0EB1A104K	T	27.9/16.5
C2222	4030016930	S.CER ECJ0EB1A104K	T	29.3/19.7
J651	6510024810	S.CON AXK6S60635P 2	B	71/24.9
J701	6510022070	S.CON AXK6S30635P 2	B	10.9/20.4
J1201	6510018891	S.CON 52559-1370(1390)	B	77.5/38.2
J2101	6510020130	S.CON AXN810535P	T	52.4/42.9
BT1301	3020000330	LIT ML920S/F9D		
EP2	6910012350	S.BEA MMZ1608Y 102BT	T	18.8/38.2
EP51	6910012350	S.BEA MMZ1608Y 102BT	B	18.1/29.7
EP201	6910014730	S.BEA MPZ2012S331A-T	T	13.3/40.6
EP301	6910012350	S.BEA MMZ1608Y 102BT	T	19.1/40
EP701	6910012350	S.BEA MMZ1608Y 102BT	B	5.6/15.3
EP2002	6910012350	S.BEA MMZ1608Y 102BT	B	38.2/27.6
EP2202	6910012350	S.BEA MMZ1608Y 102BT	T	19.1/22
EP2205	6910014730	S.BEA MPZ2012S331A-T	T	18.4/17.7
EP2217	6910015970	S.BEA MMZ1608B 301CT-AS	B	20.9/16.1

[CONNECT UNIT]

REF NO.	PARTS NO.	DESCRIPTION	M.	H/V LOCATION
J1	6510019971	S.CON 52808-1071	T	7.1/11.8
W1	8900016410	CAB OPC-1579A		

M.=Mounted side (T: Mounted on the Top side, B: Mounted on the Bottom side)
S.=Surface mount

[DDS UNIT]

REF NO.	PARTS NO.	DESCRIPTION	M.	H/V LOCATION
IC51	1190001811	S.IC AD9833BRMZ	T	38.7/3.5
IC52	1130012781	S.IC SN74AHC2G04HDC3 0	T	45/5.6
IC61	1130012610	S.IC SN74AHC1GU04DCKR	T	37.5/7.5
IC62	1130012850	S.IC SN74LVC3G34DCUR	T	51.3/24.7
IC251	1180002321	S.REG TK11218CMCL-G	B	29.5/16.2
IC301	1190002101	S.IC AD995128V	T	37.5/28.2
IC401	1110004080	S.IC UPC2709T-E3	T	50.1/47
IC451	1110006430	S.IC UPC1678GV-E1-A	T	34.1/50.2
IC801	1110006430	S.IC UPC1678GV-E1-A	T	18/13.7
IC901	1130012720	S.IC CD74HC4094PWR	T	5.4/64.7
Q1	1530002381	S.TRA 2SC4215-Y(TE85L,F)	T	20.4/3.1
Q101	1530002561	S.TRA 2SC4403-3-TL-E	T	26.5/6.4
Q151	1530003151	S.TRA 2SC4673D-TD-E	T	41.4/13.7
Q201	1530003432	S.TRA 2SC5226A-4-TL-E	T	43.4/19.4
Q211	1530003432	S.TRA 2SC5226A-4-TL-E	B	43.5/15.2
Q301	1590000680	S.TRA DTC114EU T106	B	45.3/32.3
Q901	1590003930	S.TRA UMD22N TR	T	4/58.7
Q902	1590003930	S.TRA UMD22N TR	T	4.1/55.1
Q903	1590003930	S.TRA UMD22N TR	T	7.2/55.1
Q904	1590003930	S.TRA UMD22N TR	T	7.2/58.7
Q905	1590003930	S.TRA UMD22N TR	T	4.1/70.7
Q906	1590003930	S.TRA UMD22N TR	T	4.1/74.2
Q907	1590003930	S.TRA UMD22N TR	T	7.1/70.7
Q908	1590003930	S.TRA UMD22N TR	T	7.1/74.2
Q1101	1530002060	S.TRA 2SC4081 T106 R	T	40.9/53.9
Q1102	1540000451	S.TRA 2SD1623T-TD-E	T	45.5/54.3
D301	1750000620	S.DIO MA717WK(TX)	B	44.8/35.9
D341	1790001621	S.DIO 1SV308(TPL3,F)	B	45.2/39.7
D451	1750000581	S.DIO 1SV307(TPH3,F)	T	44.2/47.7
D452	1750000581	S.DIO 1SV307(TPH3,F)	T	44/44.8
D453	1790001621	S.DIO 1SV308(TPL3,F)	T	43.3/36.6
D454	1750000581	S.DIO 1SV307(TPH3,F)	T	38.3/48.3
D456	1750000620	S.DIO MA717WK(TX)	B	35.1/42.8
D458	1750000581	S.DIO 1SV307(TPH3,F)	T	33.8/45.6
D459	1750000581	S.DIO 1SV307(TPH3,F)	T	31.3/38.8
D471	1750000620	S.DIO MA717WK(TX)	T	33.2/36.6
D501	1750000581	S.DIO 1SV307(TPH3,F)	B	26.2/42.6
D502	1750000581	S.DIO 1SV307(TPH3,F)	T	3/50.6
D551	1750000581	S.DIO 1SV307(TPH3,F)	T	25.9/45.1
D552	1750000581	S.DIO 1SV307(TPH3,F)	T	2.9/45.3
D601	1750000581	S.DIO 1SV307(TPH3,F)	T	27.2/39.9
D602	1750000581	S.DIO 1SV307(TPH3,F)	T	2.9/40.1
D651	1750000581	S.DIO 1SV307(TPH3,F)	T	27.2/34.8
D652	1750000581	S.DIO 1SV307(TPH3,F)	T	2.9/34.9
D701	1750000581	S.DIO 1SV307(TPH3,F)	T	27.2/29.5
D702	1750000581	S.DIO 1SV307(TPH3,F)	T	2.9/29.7
D751	1750000581	S.DIO 1SV307(TPH3,F)	T	27/24.4
D752	1750000581	S.DIO 1SV307(TPH3,F)	T	2.9/24.6
D801	1750000581	S.DIO 1SV307(TPH3,F)	T	28.3/21.6
D802	1750000581	S.DIO 1SV307(TPH3,F)	T	2.9/19.3
D1101	1750000301	S.DIO 1S302(TE85R,F)	T	40.9/57.7
D1102	1160000080	S.DIO DAP202K T146	B	27.9/63
FI101	2010002660	S.XTA DSF334SAF 124.032 MHz(FL-391)	T	29.3/10.7
FI201	2040001860	S.SAW NSVS776	T	34.5/16.5
X1	6050012800	S.XTA CR-788B VC-TXCO 24.8064 MHz	T	13.8/3.7
L1	6200002641	S.COI NLV25T-R15J	T	26/3.7
L51	6200005011	S.COI NLV25T-100J	B	35.6/4.2
L52	6200005011	S.COI NLV25T-100J	B	38.8/3.8
L53	6200003241	S.COI NLV32T-221J	B	43.4/8.7
L54	6200009351	S.COI ELJRE R22GFA	T	34.6/8.6
L101	6200003540	S.COI MLF1608D R22K-T	T	24.2/8.8
L105	6200012650	S.COI MLF1608A 1R5J-T	T	23.7/5.2
L151	6200004470	S.COI MLF1608D R12K-T	T	44.7/12.8
L153	6200004150	S.COI MLF1608D 47NM-T	T	46.9/15.7
L201	6200004150	S.COI MLF1608D 47NM-T	T	44.5/21.5
L202	6200005661	S.COI ELJRE 10NGFA	B	37.5/12.4
L204	6200003540	S.COI MLF1608D R22K-T	T	41.5/19.3
L205	6200005711	S.COI ELJRE 27NGFA	B	47.1/21.7
L206	6200005701	S.COI ELJRE 22NGFA	B	46.2/20.4
L210	6200005701	S.COI ELJRE 22NGFA	B	47/19.1
L212	6200002581	S.COI NLV25T-033J	B	41.9/12.8
L213	6200005681	S.COI ELJRE 15NGFA	B	40.1/17.8
L301	6140002810	S.COI LR-317	T	48.5/30
L302	6140002810	S.COI LR-317	T	48.7/38.9
L303	6200004150	S.COI MLF1608D 47NM-T	B	41.9/35.7
L304	6200003960	S.COI MLF1608A 1R0K-T	T	50.4/33.2
	6200003960	S.COI MLF1608A 1R0K-T	[EUR]	
	6200003960	S.COI MLF1608A 1R0K-T	[FRA]	
	6200003960	S.COI MLF1608A 1R0K-T	[ESP]	
	6200003960	S.COI MLF1608A 1R0K-T	[USA]	
	6200003960	S.COI MLF1608A 1R0K-T	[EXP]	
	6200003960	S.COI MLF1608A 1R0K-T	[ITR]	
	6200003960	S.COI MLF1608A 1R0K-T	[UK]	
	6200003960	S.COI MLF1608A 1R0K-T	[KOR]	
	6200003960	S.COI MLF1608A 1R0K-T	[CHN]	
L321	6200009560	S.COI MLG1608B R10J-T	T	50.4/34.7
L322	6200011770	S.COI LQW18ANR10G00D	T	47.8/34.7
L323	6200005671	S.COI ELJRE 12NGFA	T	53.6/30.1
L331	6200009680	S.COI MLG1608B 47NJ-T	T	47.6/43.1
L332	6200009680	S.COI MLG1608B 47NJ-T	T	50.2/43.1

[DDS UNIT]

REF NO.	PARTS NO.	DESCRIPTION	M.	H/V LOCATION
L341	6200004470	S.COI MLF1608D R12K-T	B	41.1/37
L401	6200001981	S.COI NLV25T-1R0J	T	50.2/49.9
L411	6200009610	S.COI MLG1608B 39NJ-T	T	47.3/48.3
L456	6140002810	S.COI LR-317	T	40.1/44.9
L458	6200009680	S.COI MLG1608B 47NJ-T	B	37.5/42.1
L461	6200009660	S.COI MLG1608B 10NJ-T	B	39.3/41.7
L464	6200002631	S.COI NLV25T-R10J	T	28.8/50.6
L465	6200004470	S.COI MLF1608D R12K-T	T	42.9/39.5
L466	6200011580	S.COI LQW18AN33NG00D	T	39.1/41.1
L467	6200009670	S.COI MLG1608B 12NJ-T	T	27.7/47.1
L468	6200009590	S.COI MLG1608B 18NJ-T	T	26.1/48.3
L469	6200009580	S.COI MLG1608B 15NJ-T	T	33.6/41.3
L471	6140002810	S.COI LR-317	T	38.7/37.2
L472	6200009680	S.COI MLG1608B 47NJ-T	T	33.4/39.3
L473	6200009540	S.COI MLG1608B 22NJ-T	T	35.5/40.4
L501	6200002611	S.COI NLV25T-R47J	B	21.7/43.6
L502	6200002631	S.COI NLV25T-R10J	B	18.1/46.7
L503	6200002431	S.COI NLV25T-082J	B	15/46.4
L504	6200002411	S.COI NLV25T-056J	T	14.3/42.9
L505	6200002421	S.COI NLV25T-068J	T	11.2/50.2
L506	6200002421	S.COI NLV25T-068J	T	8.2/49.7
L507	6200002611	S.COI NLV25T-R47J	T	3.8/48.2
L551	6200002611	S.COI NLV25T-R47J	T	24.9/42.6
L552	6200002421	S.COI NLV25T-068J	T	20.3/43
L553	6200002411	S.COI NLV25T-056J	T	17.6/42.9
L554	6200002601	S.COI NLV25T-047J	T	14.7/45
L555	6200002601	S.COI NLV25T-047J	T	12/43.4
L556	6200002581	S.COI NLV25T-033J	T	9.2/45
L557	6200002611	S.COI NLV25T-R47J	T	4.5/42.8
L601	6200002611	S.COI NLV25T-R47J	T	25.3/37.4
L602	6200002601	S.COI NLV25T-047J	T	22.6/39.6
L603	6200002591	S.COI NLV25T-039J	T	19.7/39.1
L604	6200003891	S.COI NLV25T-027J	T	16.8/39.9
L605	6200002601	S.COI NLV25T-047J	T	14.1/37.9
L606	6200002601	S.COI NLV25T-047J	T	11.4/37.7
L607	6200002421	S.COI NLV25T-068J	T	8.6/37.7
L608	6200002601	S.COI NLV25T-047J	T	5.1/37.7
L651	6200002611	S.COI NLV25T-R47J	T	26/32.2
L652	6200002591	S.COI NLV25T-039J	T	22.4/32.5
L653	6200002591	S.COI NLV25T-039J	T	19.6/32.8
L654	6200002591	S.COI NLV25T-039J	T	14/34.6
L655	6200002591	S.COI NLV25T-039J	T	11.2/33.9
L656	6200002601	S.COI NLV25T-047J	T	16.7/32.5
L657	6200002581	S.COI NLV25T-033J	T	7.9/34.6
L658	6200002611	S.COI NLV25T-R47J	T	5.2/32.6
L701	6200002611	S.COI NLV25T-R47J	T	26/26.9
L702	6200002581	S.COI NLV25T-033J	T	22.9/29.2
L703	6200002581	S.COI NLV25T-033J	T	20.2/28.7
L704	6200003891	S.COI NLV25T-027J	T	17.3/29.5
L705	6200002591	S.COI NLV25T-039J	T	14.6/27.3
L706	6200002581	S.COI NLV25T-033J	T	11.8/27.3
L707	6200002581	S.COI NLV25T-033J	T	9.1/27.2
L708	6200002611	S.COI NLV25T-R47J	T	4.5/27.2
L751	6200002611	S.COI NLV25T-R47J	T	25.9/22
L752	6200003881	S.COI NLV25T-022J	T	22.4/22.4
L753	6200003891	S.COI NLV25T-027J	T	19.7/22.2
L754	6200002581	S.COI NLV25T-033J	T	16.9/22.5
L755	6200003891	S.COI NLV25T-027J	T	14.2/22.2
L756	6200003891	S.COI NLV25T-027J	T	11.4/23.5
L757	6200003881	S.COI NLV25T-022J	T	8.7/24.2
L758	6200002611	S.COI NLV25T-R47J	T	3.9/22.2
L801	6200002181	S.COI NLV25T-R12J	T	28.3/17.5
L803	6200005711	S.COI ELJRE 27NGFA	T	26.3/17.6
L804	6200009070	S.COI LQW18AN18NG00D	T	25/15.6
L805	6200009220	S.COI LQW18AN15NG00D	T	23.1/14.9
		(LQW1608A15NG00)		
L806	6200005641	S.COI ELJRE 6N8ZFA	T	21.5/19
L807	6200009670	S.COI MLG1608B 12NJ-T	T	18.7/18.2
L808	6200004720	S.COI MLF1608D R10K-T	T	17.9/10
L812	6200005711	S.COI ELJRE 27NGFA	T	14.8/14.4
L813	6200009070	S.COI LQW18AN18NG00D	T	15.7/17.2
		(LQW1608A18NG00)		
L814	6200009220	S.COI LQW18AN15NG00D	T	13.8/18.2
		(LQW1608A15NG00)		
L815	6200005641	S.COI ELJRE 6N8ZFA	T	10.1/18
L816	6200010700	S.COI LQW18AN12NG00D	T	6.6/17.8
L818	6200002181	S.COI NLV25T-R12J	T	4.6/17
L851	6200002181	S.COI NLV25T-R12J	B	26.8/30.6
L852	6200002611	S.COI NLV25T-R47J	B	26.4/34.1
L853	6200002181	S.COI NLV25T-R12J	B	3.4/28.8
L854	6200002611	S.COI NLV25T-R47J	B	5.4/26
L901	6200007420	S.COI ELJFC 101K-F	B	3.7/65.9
L953	6200002041	S.COI NLV25T-101J	B	56.4/44.6
L954	6200002041	S.COI NLV25T-101J	B	55.7/42.1
L955	6200002041	S.COI NLV25T-101J	B	55.9/39.6
L956	6200002041	S.COI NLV25T-101J	B	56.1/37.1
L957	6200002041	S.COI NLV25T-101J	B	55.9/34.6
L959	6200011300	S.COI EXCML16A270U	T	54.9/34.3
L960	6200002041	S.COI NLV25T-101J	B	56.6/30.3
L962	6200011300	S.COI EXCML16A270U	B	59.2/32.2
L963	6200011300	S.COI EXCML16A270U	B	60.4/32.2
L1001	6200003241	S.COI NLV32T-221J	B	53.7/50.8
L1002	6200003241	S.COI NLV32T-221J	B	47.9/55
L1103	6200002041	S.COI NLV25T-101J	B	42.2/61.2
L1105	6200002041	S.COI NLV25T-101J	B	40.8/71.8
L1106	6200002041	S.COI NLV25T-101J	T	36.4/62.3
L1107	6200002041	S.COI NLV25T-101J	B	34.9/74.7
L1110	6200002041	S.COI NLV25T-101J	T	32.4/62.3

M.=Mounted side (T: Mounted on the Top side, B: Mounted on the Bottom side) S.=Surface mount

[DDS UNIT]

REF NO.	PARTS NO.	DESCRIPTION	M.	H/V LOCATION
L1111	6200002041	S.COI NLV25T-101J	B	26.1/69.8
L1112	6200002041	S.COI NLV25T-101J	T	29.9/62.3
L1152	6200003590	S.COI EXCCL3225U1	T	48.3/69.2
L1153	6200002041	S.COI NLV25T-101J	T	45.5/69.3
L1154	6200002041	S.COI NLV25T-101J	T	53.6/69.2
R2	7030007290	S.RES ERJ2GEJ 222 X (2.2K)	T	19.1/4.5
R3	7030005040	S.RES ERJ2GEJ 472 X (4.7K)	T	18.6/1.8
R4	7030004990	S.RES ERJ2GEJ 221 X (220)	T	22.2/2.6
R5	7030004980	S.RES ERJ2GEJ 101 X (100)	T	20.9/6.9
R8	7030003630	S.RES ERJ3GEYJ 393 V (39K)	B	13.6/7.1
R9	7030003610	S.RES ERJ3GEYJ 273 V (27K)	B	13.6/9.7
R10	7030005060	S.RES ERJ2GEJ 333 X (33K)	T	8/3.2
R11	7030010040	S.RES ERJ2GEJ-JPW	T	9.2/3.7
R51	7030005120	S.RES ERJ2GEJ 102 X (1K)	T	35.7/9.5
R52	7030005120	S.RES ERJ2GEJ 102 X (1K)	T	46.1/2.3
R53	7030005120	S.RES ERJ2GEJ 102 X (1K)	T	42.8/3.5
R54	7030005120	S.RES ERJ2GEJ 102 X (1K)	T	42.8/2.6
R61	7030005050	S.RES ERJ2GEJ 103 X (10K)	T	39.3/8.1
R62	7030005530	S.RES ERJ2GEJ 100 X (10)	T	49.3/23.1
R101	7030005000	S.RES ERJ2GEJ 471 X (470)	T	25.2/7.8
R102	7030004980	S.RES ERJ2GEJ 101 X (100)	T	22.1/7.4
R103	7030005570	S.RES ERJ2GEJ 820 X (82)	T	31.8/11.1
R104	7030004980	S.RES ERJ2GEJ 101 X (100)	T	33/11.5
R105	7030005570	S.RES ERJ2GEJ 820 X (82)	T	34.2/11.2
R106	7030005100	S.RES ERJ2GEJ 154 X (150K)	T	23.9/7.4
R121	7030005040	S.RES ERJ2GEJ 472 X (4.7K)	T	38.5/11.1
R150	7030005570	S.RES ERJ2GEJ 820 X (82)	T	45.8/10.7
R151	7030004980	S.RES ERJ2GEJ 101 X (100)	T	44.9/10.7
R154	7030005050	S.RES ERJ2GEJ 103 X (10K)	T	41.4/10.6
R155	7030005530	S.RES ERJ2GEJ 100 X (10)	T	46.3/12.6
R157	7030007270	S.RES ERJ2GEJ 151 X (150)	T	48.8/18.2
R158	7030009200	S.RES ERJ2GEJ 390 X (39)	T	48/16.7
R159	7030007270	S.RES ERJ2GEJ 151 X (150)	T	47.9/18.2
R160	7030005300	S.RES ERJ2GEJ 150 X (15)	T	44.2/15.9
R161	7030004980	S.RES ERJ2GEJ 101 X (100)	T	45.1/15.9
R162	7030005300	S.RES ERJ2GEJ 150 X (15)	T	45/14.6
R201	7030005530	S.RES ERJ2GEJ 100 X (10)	T	45.8/22
R202	7030000700	S.RES MCR10EZHJ 470 K (474)	T	45.6/18.8
R211	7030003400	S.RES ERJ3GEYJ 471 V (470)	B	37.3/17.8
R212	7030003440	S.RES ERJ3GEYJ 102 V (1K)	B	40.8/16.2
R213	7030003200	S.RES ERJ3GEYJ 100 V (10)	B	44.5/11.4
R214	7030003280	S.RES ERJ3GEYJ 470 V (47)	B	46.8/16.3
R301	7030005120	S.RES ERJ2GEJ 102 X (1K)	T	34.2/22.2
R303	7030010040	S.RES ERJ2GEJ-JPW	T	40/22.2
R304	7030005120	S.RES ERJ2GEJ 102 X (1K)	T	42/24.6
R305	7030005710	S.RES ERJ2GEJ 121 X (120)	T	44.1/28.9
R306	7030005120	S.RES ERJ2GEJ 102 X (1K)	T	31.5/25.6
R309	7030005120	S.RES ERJ2GEJ 102 X (1K)	T	31.2/29.4
R310	7030005120	S.RES ERJ2GEJ 102 X (1K)	T	31.2/30.5
R311	7030005120	S.RES ERJ2GEJ 102 X (1K)	T	31.2/31.5
R312	7030010040	S.RES ERJ2GEJ-JPW	T	32.9/31.7
R313	7030005710	S.RES ERJ2GEJ 121 X (120)	T	43.2/28.5
R314	7030009140	S.RES ERJ2GEJ 272 X (2.7K)	T	43/31.8
R315	7030005120	S.RES ERJ2GEJ 102 X (1K)	T	33.5/32.6
R316	7030005050	S.RES ERJ2GEJ 103 X (10K)	T	34.6/33.8
R317	7030004990	S.RES ERJ2GEJ 221 X (220)	T	43.9/31.8
R318	7030003860	S.RES ERJ3GE JPW V [EUR]	B	35.8/28.4
	7030003860	S.RES ERJ3GE JPW V [FRA]		
	7030003860	S.RES ERJ3GE JPW V [ESP]		
	7030003860	S.RES ERJ3GE JPW V [USA]		
	7030003860	S.RES ERJ3GE JPW V [EXP]		
	7030003860	S.RES ERJ3GE JPW V [ITR]		
	7030003860	S.RES ERJ3GE JPW V [KOR]		
	7030003860	S.RES ERJ3GE JPW V [AUS]		
	7030003860	S.RES ERJ3GE JPW V [CHN]		
R341	7030003440	S.RES ERJ3GEYJ 102 V (1K)	B	44.3/38.3
R342	7030003440	S.RES ERJ3GEYJ 102 V (1K)	B	45.9/41.2
R451	7030005120	S.RES ERJ2GEJ 102 X (1K)	T	44.5/46.2
R452	7030003860	S.RES ERJ3GE JPW V	B	48.6/44.6
R453	7030010090	S.RES ERJ2GEJ 180 X (18)	T	34.1/47.4
R454	7030008280	S.RES ERJ2GEJ 271 X (270)	T	32.9/47
R455	7030008280	S.RES ERJ2GEJ 271 X (270)	T	32.9/47.9
R456	7030010040	S.RES ERJ2GEJ-JPW	T	34.9/52.4
R457	7030005120	S.RES ERJ2GEJ 102 X (1K)	T	38.1/49.7
R458	7030004990	S.RES ERJ2GEJ 221 X (220)	T	31.6/43.6
R459	7030005090	S.RES ERJ2GEJ 104 X (100K)	T	42.1/50
R460	7030003680	S.RES ERJ3GEYJ 104 V (100K)	T	30.7/41
R461	7030005090	S.RES ERJ2GEJ 104 X (100K)	T	29.6/39.1
R462	7030003860	S.RES ERJ3GE JPW V	T	45/43.3
R463	7030003400	S.RES ERJ3GEYJ 471 V (470)	T	33.3/44
R464	7030004980	S.RES ERJ2GEJ 101 X (100)	T	40.8/47.9
R465	7030005570	S.RES ERJ2GEJ 820 X (82)	T	40.3/50
R467	7030005570	S.RES ERJ2GEJ 820 X (82)	T	40.8/48.8
R468	7030005570	S.RES ERJ2GEJ 820 X (82)	T	41.2/50
R469	7030003320	S.RES ERJ3GEYJ 101 V (100)	B	37.7/39.9
R471	7030005000	S.RES ERJ2GEJ 471 X (470)	T	41.6/37.7
R472	7030004990	S.RES ERJ2GEJ 221 X (220)	T	30.3/43.3
R473	7030007270	S.RES ERJ2GEJ 151 X (150)	T	31.7/34.5
R474	7030009200	S.RES ERJ2GEJ 390 X (39)	T	31.3/35.7
R475	7030007270	S.RES ERJ2GEJ 151 X (150)	T	30.1/35.3
R476	7030005000	S.RES ERJ2GEJ 471 X (470)	T	29.9/37.9
R477	7030003320	S.RES ERJ3GEYJ 101 V (100)	B	35.7/38.6
R501	7030003390	S.RES ERJ3GEYJ 391 V (390)	B	21/46.1
R502	7030009280	S.RES ERJ2GEJ 391 X	T	5.8/46.8
R503	7030005090	S.RES ERJ2GEJ 104 X (100K)	T	14.3/46.8
R505	7030005570	S.RES ERJ2GEJ 820 X (82)	T	6.5/48.6
R506	7030005570	S.RES ERJ2GEJ 820 X (82)	T	6/49.8

[DDS UNIT]

REF NO.	PARTS NO.	DESCRIPTION	M.	H/V LOCATION
R507	7030005570	S.RES ERJ2GEJ 820 X (82)	T	5.6/48.6
R551	7030009280	S.RES ERJ2GEJ 391 X	T	23.1/42
R552	7030009280	S.RES ERJ2GEJ 391 X	T	6.3/42
R553	7030005090	S.RES ERJ2GEJ 104 X (100K)	T	10.1/41.6
R554	7030009200	S.RES ERJ2GEJ 390 X (39)	T	6.4/45.7
R555	7030007270	S.RES ERJ2GEJ 101 X (100)	T	7.1/44.4
R556	7030007270	S.RES ERJ2GEJ 151 X (150)	T	6.2/44.3
R601	7030008280	S.RES ERJ2GEJ 271 X (270)	T	23.2/36.1
R602	7030009280	S.RES ERJ2GEJ 391 X	T	6.8/36.6
R603	7030005090	S.RES ERJ2GEJ 104 X (100K)	T	19.6/36.4
R604	7030004980	S.RES ERJ2GEJ 101 X (100)	T	20.8/36.1
R651	7030009280	S.RES ERJ2GEJ 391 X	T	24.2/31.2
R652	7030009280	S.RES ERJ2GEJ 391 X	T	6.3/30.5
R653	7030005090	S.RES ERJ2GEJ 104 X (100K)	T	9.9/31.2
R701	7030009280	S.RES ERJ2GEJ 391 X	T	23.8/25.8
R702	7030009280	S.RES ERJ2GEJ 391 X	T	6.5/26
R703	7030005090	S.RES ERJ2GEJ 104 X (100K)	T	19.9/26
R704	7030004980	S.RES ERJ2GEJ 101 X (100)	T	7.2/27.2
R705	7030005710	S.RES ERJ2GEJ 121 X (120)	T	6.7/28.4
R706	7030004980	S.RES ERJ2GEJ 101 X (100)	T	6.3/27.2
R751	7030009280	S.RES ERJ2GEJ 391 X	T	24.2/21
R752	7030009280	S.RES ERJ2GEJ 391 X	T	5.9/20.8
R753	7030005090	S.RES ERJ2GEJ 104 X (100K)	T	10.3/20.8
R755	7030004980	S.RES ERJ2GEJ 101 X (100)	T	6.6/22.6
R756	7030005580	S.RES ERJ2GEJ 560 X (56)	T	6.6/24.2
R757	7030004980	S.RES ERJ2GEJ 101 X (100)	T	5.7/23.3
R801	7030008280	S.RES ERJ2GEJ 271 X (270)	T	27.2/14.5
R805	7030005570	S.RES ERJ2GEJ 820 X (82)	T	13.9/10.3
R806	7030005570	S.RES ERJ2GEJ 820 X (82)	T	14.2/11.7
R807	7030005570	S.RES ERJ2GEJ 820 X (82)	T	13/11.3
R808	7030003390	S.RES ERJ3GEYJ 391 V (390)	B	3.6/17.9
R810	7030005090	S.RES ERJ2GEJ 104 X (100K)	T	27.2/15.4
R841	7030005710	S.RES ERJ2GEJ 121 X (120)	T	21.2/12.5
R851	7030009280	S.RES ERJ2GEJ 391 X	T	27.1/37.3
R852	7030008280	S.RES ERJ2GEJ 271 X (270)	T	5.7/13.7
R853	7030010090	S.RES ERJ2GEJ 180 X (18)	T	6.9/14
R854	7030008280	S.RES ERJ2GEJ 271 X (270)	T	6.9/13
R855	7030003390	S.RES ERJ3GEYJ 391 V (390)	B	5.5/29.5
R901	7030005120	S.RES ERJ2GEJ 102 X (1K)	T	2.1/62.6
R902	7030005120	S.RES ERJ2GEJ 102 X (1K)	T	2.2/60.9
R903	7030005120	S.RES ERJ2GEJ 102 X (1K)	T	2.2/58.7
R951	7030003360	S.RES ERJ3GEYJ 221 V (220)	B	59.2/6.9
R952	7030004990	S.RES ERJ2GEJ 221 X (220)	T	54/9.3
R953	7030003360	S.RES ERJ3GEYJ 221 V (220)	B	59.5/3.3
R954	7030004990	S.RES ERJ2GEJ 221 X (220)	T	53.1/8.9
R955	7030004990	S.RES ERJ2GEJ 221 X (220)	T	55.2/7.7
R956	7030003360	S.RES ERJ3GEYJ 221 V (220)	B	59.2/4.9
R957	7030003360	S.RES ERJ3GEYJ 221 V (220)	B	56.6/5
R958	7030004990	S.RES ERJ2GEJ 221 X (220)	T	47.2/6.1
R959	7030003360	S.RES ERJ3GEYJ 221 V (220)	B	57.9/5.1
R960	7030003280	S.RES ERJ3GEYJ 470 V (47)	B	57.5/49
R961	7030004990	S.RES ERJ2GEJ 221 X (220)	T	54.6/11.6
R962	7030003860	S.RES ERJ3GE JPW V	T	51.3/21
R1051	7030003860	S.RES ERJ3GE JPW V	B	10.8/73
R1101	7030005120	S.RES ERJ2GEJ 102 X (1K)	T	40.5/52.1
R1102	7030005050	S.RES ERJ2GEJ 103 X (10K)	T	42.1/52.1
R1103	7030004980	S.RES ERJ2GEJ 101 X (100)	T	39.3/63.4
R1104	7030005050	S.RES ERJ2GEJ 103 X (10K)	T	44.2/51.2
R1105	7030004980	S.RES ERJ2GEJ 101 X (100)	T	38.7/60.9
R1106	7030007290	S.RES ERJ2GEJ 222 X (2.2K)	T	31.8/59.6
R1107	7030007290	S.RES ERJ2GEJ 222 X (2.2K)	T	28.1/59.6
R1108	7030005240	S.RES ERJ2GEJ 473 X (47K)	T	46.9/8.5
R1109	7030005240	S.RES ERJ2GEJ 473 X (47K)	T	47.9/8.5
C1	4030016950	S.CER ECJ0EB1A473K	T	17.5/4.5
C2	4030017780	S.CER ECJ0EB1E472K	T	20.9/5
C3	4030017510	S.CER ECJ0EC1H680J	T	24.8/1.7
C4	4030017780	S.CER ECJ0EB1E472K	T	22.3/4.6
C5	4030017680	S.CER ECJ0EC1H820J	T	26/2
C6	4030017510	S.CER ECJ0EC1H680J	T	27.2/1.7
C7	4030016930	S.CER ECJ0EB1A104K	T	8/4.1
C8	4030016790	S.CER ECJ0EB1C103K	T	10.1/5.7
C51	4030017780	S.CER ECJ0EB1E472K	T	33.8/6.5
C52	4030017780	S.CER ECJ0EB1E472K	T	36.1/5.3
C53	4030017780	S.CER ECJ0EB1E472K	T	36.9/9.4
C54	4030016930	S.CER ECJ0EB1A104K	T	34.9/4.4
C55	4510008580	S.ELE EEE0JA470SR	T	30.6/3.9
C56	4030016930	S.CER ECJ0EB1A104K	T	34.9/2.8
C57	4030016930	S.CER ECJ0EB1A104K	T	42.8/5
C58	4030016930	S.CER ECJ0EB1A104K	T	41.5/9
C59	4030017720	S.CER ECJ0EB1H331K	T	41.9/6.6
C60	4030017690	S.CER ECJ0EC1H121J	T	42.2/7.8
C61	4030017720	S.CER ECJ0EB1H331K	T	42.8/6.6
C62	4030016930	S.CER ECJ0EB1A104K	T	35.6/6.5
C63	4030016930	S.CER ECJ0EB1A104K	T	49.3/22.2
C64	4030017710	S.CER ECJ0EC1H181J	T	34.7/6.5
C65	4030017710	S.CER ECJ0EC1H181J	T	33.4/8.9
C101	4030017580	S.CER ECJ0EC1H060C	T	26.4/8.7
C102	4030017660	S.CER ECJ0EC1H330J	T	23.1/2.6
C104	4030017780	S.CER ECJ0EB1E472K	T	20.9/7.8
C105	4030017460	S.CER ECJ0EB1E102K	T	24.8/6.5
C120	4030017780	S.CER ECJ0EB1E472K	T	37.3/11.5
C126	4030017780	S.CER ECJ0EB1E472		

[DDS UNIT]

REF NO.	PARTS NO.	DESCRIPTION	M.	H/V LOCATION
C156	4030017660	S.CER ECJ0EC1H330J	T	47/18.2
C157	4030007090	S.CER C1608 CH 1H 470J-T	B	53/15.3
C202	4030017590	S.CER ECJ0EC1H070C	T	43.8/17.2
C203	4030007060	S.CER C1608 CH 1H 270J-T	B	37.8/15.9
C204	4030016930	S.CER ECJ0EB1A104K	T	35.1/20.1
C206	4030017560	S.CER ECJ0EC1H2R5B	T	43.4/21.7
C207	4030007110	S.CER C1608 CH 1H 680J-T	B	44/21.7
C208	4030009910	S.CER C1608 CH 1H 040B-T	B	40.9/21.7
C209	4030007060	S.CER C1608 CH 1H 060B-T	B	43.1/20.4
C210	4030009910	S.CER C1608 CH 1H 040B-T	B	40.8/19.8
C211	4030017460	S.CER ECJ0EB1E102K	T	42.2/17.6
C216	4030017780	S.CER ECJ0EB1E472K	T	46.3/20.8
C217	4030007120	S.CER C1608 CH 1H 820J-T	B	43.9/19.1
C218	4030011770	S.CER C1608 CH 1H 060B-T	B	43.2/17.8
C219	4030007010	S.CER C1608 CH 1H 100D-T	B	46.2/17.8
C221	4030006880	S.CER C1608 JB 1H 472K-T	B	46/15
C222	4030009910	S.CER C1608 CH 1H 040B-T	B	40.7/14.7
C223	4030006880	S.CER C1608 JB 1H 472K-T	B	46/13.4
C224	4030018630	S.CER C2012 CH 1H 472J-T	B	39.2/11.4
C225	4030006860	S.CER C1608 JB 1H 102K-T	B	38.4/19.4
C251	4030011600	S.CER C1608 JB 1E 104K-T	B	27.6/12.2
C252	4030011600	S.CER C1608 JB 1E 104K-T	B	28.7/23.5
C253	4550007090	S.TAN TEESVA 1A 226M8R	B	29.6/21.7
C254	4030011600	S.CER C1608 JB 1E 104K-T	B	29.2/12.2
C255	4550007090	S.TAN TEESVA 1A 226M8R	B	29.5/19.3
C302	4030016930	S.CER ECJ0EB1A104K	T	36.2/22.2
C303	4030016930	S.CER ECJ0EB1A104K	T	37.3/22.2
C304	4030016930	S.CER ECJ0EB1A104K	T	38.2/22.2
C305	4030016930	S.CER ECJ0EB1A104K	T	39.1/22.2
C306	4030016930	S.CER ECJ0EB1A104K	T	43.6/24.6
C307	4030016930	S.CER ECJ0EB1A104K	T	31.2/28.3
C308	4030016930	S.CER ECJ0EB1A104K	T	43.6/25.5
C309	4030016930	S.CER ECJ0EB1A104K	T	43/26.7
C310	4030016930	S.CER ECJ0EB1A104K	T	43.9/26.7
C312	4030016930	S.CER ECJ0EB1A104K	T	43.4/30.6
C317	4030011600	S.CER C1608 JB 1E 104K-T	B	44/26.1
C318	4030006880	S.CER C1608 JB 1H 472K-T	B	39.2/25.4
C321	4030017420	S.CER ECJ0EC1H470J	T	51.2/30.2
C323	4030017510	S.CER ECJ0EC1H680J	T	48.6/33.3
C325	4030017660	S.CER ECJ0EC1H330J	T	48.8/35.7
C326	4030017640	S.CER ECJ0EC1H150J	T	53.1/32
C328	4030006880	S.CER C1608 JB 1H 472K-T	[EUR] B	39.7/29.6
	4030006880	S.CER C1608 JB 1H 472K-T	[FRA]	
	4030006880	S.CER C1608 JB 1H 472K-T	[ESP]	
	4030006880	S.CER C1608 JB 1H 472K-T	[USA]	
	4030006880	S.CER C1608 JB 1H 472K-T	[EXP]	
	4030006880	S.CER C1608 JB 1H 472K-T	[ITR]	
	4030006880	S.CER C1608 JB 1H 472K-T	[KOR]	
	4030006880	S.CER C1608 JB 1H 472K-T	[AUS]	
	4030006880	S.CER C1608 JB 1H 472K-T	[CHN]	
C331	4030017390	S.CER ECJ0EC1H180J	T	46.6/44.5
C333	4030017670	S.CER ECJ0EC1H390J	T	48.4/44.5
C335	4030017390	S.CER ECJ0EC1H180J	T	50.2/44.5
C341	4030007130	S.CER C1608 CH 1H 101J-T	[EUR] B	42.5/39.7
	4030007130	S.CER C1608 CH 1H 101J-T	[FRA]	
	4030007130	S.CER C1608 CH 1H 101J-T	[ESP]	
	4030007130	S.CER C1608 CH 1H 101J-T	[USA]	
	4030007130	S.CER C1608 CH 1H 101J-T	[EXP]	
	4030007130	S.CER C1608 CH 1H 101J-T	[ITR]	
	4030007090	S.CER C1608 CH 1H 470J-T	[UK]	
	4030007130	S.CER C1608 CH 1H 101J-T	[KOR]	
	4030007130	S.CER C1608 CH 1H 101J-T	[AUS]	
	4030007130	S.CER C1608 CH 1H 101J-T	[CHN]	
C342	4030007090	S.CER C1608 CH 1H 470J-T	B	43.7/42.1
C343	4030007140	S.CER C1608 CH 1H 121J-T	B	41.3/39
C344	4030007100	S.CER C1608 CH 1H 560J-T	B	42.7/34.3
C345	4030017510	S.CER ECJ0EC1H680J	T	45.5/37.9
C346	4030017510	S.CER ECJ0EC1H680J	T	45.7/39.7
C347	4030006860	S.CER C1608 JB 1H 102K-T	[EUR] B	48.4/31.7
	4030006860	S.CER C1608 JB 1H 102K-T	[FRA]	
	4030006860	S.CER C1608 JB 1H 102K-T	[ESP]	
	4030006860	S.CER C1608 JB 1H 102K-T	[USA]	
	4030006860	S.CER C1608 JB 1H 102K-T	[EXP]	
	4030006860	S.CER C1608 JB 1H 102K-T	[ITR]	
	4030006860	S.CER C1608 JB 1H 102K-T	[KOR]	
	4030006860	S.CER C1608 JB 1H 102K-T	[AUS]	
	4030006860	S.CER C1608 JB 1H 102K-T	[CHN]	
C401	4030017460	S.CER ECJ0EB1E102K	T	51.1/44.5
C402	4030017460	S.CER ECJ0EB1E102K	T	52.3/48.9
C403	4030017430	S.CER ECJ0EC1H101J	T	47.9/46.1
C411	4030017400	S.CER ECJ0EC1H220J	T	48.1/49.7
C412	4030017630	S.CER ECJ0EC1H120J	T	47.7/47.3
C413	4030017400	S.CER ECJ0EC1H220J	T	46.7/49.4
C451	4030017420	S.CER ECJ0EC1H470J	T	40.2/40.6
C453	4030017460	S.CER ECJ0EB1E102K	T	46.1/46.8
C454	4030017460	S.CER ECJ0EB1E102K	T	35.3/47.9
C456	4030016930	S.CER ECJ0EB1A104K	T	31.2/48
C457	4030017460	S.CER ECJ0EB1E102K	T	35.3/47
C458	4030017460	S.CER ECJ0EB1E102K	T	30.5/49.8
C459	4030017460	S.CER ECJ0EB1E102K	T	27/50.6
C460	4030017780	S.CER ECJ0EB1E472K	T	39.3/50
C461	4030006880	S.CER C1608 JB 1H 472K-T	T	30.7/42.2
C463	4030017420	S.CER ECJ0EC1H470J	T	40.6/41.8
C464	4030017690	S.CER ECJ0EC1H121J	T	41.5/40.2
C465	4030017400	S.CER ECJ0EC1H220J	T	37.7/41.8
C466	4030017570	S.CER ECJ0EC1H040B	T	38.1/40.6
C467	4030017400	S.CER ECJ0EC1H220J	T	37.2/40.6
C468	4030017360	S.CER ECJ0EC1H030B	T	29/48
C469	4030017370	S.CER ECJ0EC1H3R5B	T	29/47.1

[DDS UNIT]

REF NO.	PARTS NO.	DESCRIPTION	M.	H/V LOCATION
C470	4030017380	S.CER ECJ0EC1H050B	T	29/46.2
C471	4030017380	S.CER ECJ0EC1H050B	T	35.6/43.9
C472	4030017660	S.CER ECJ0EC1H330J	T	34.7/41.8
C473	4030017570	S.CER ECJ0EC1H040B	T	34/43
C474	4030017460	S.CER ECJ0EB1E102K	T	41.6/36.7
C475	4030017460	S.CER ECJ0EB1E102K	T	30.5/36.7
C476	4030017780	S.CER ECJ0EB1E472K	T	29.6/40
C477	4030017780	S.CER ECJ0EB1E472K	T	42.4/48.8
C478	4030006880	S.CER C1608 JB 1H 472K-T	B	39.8/39.1
C479	4030006880	S.CER C1608 JB 1H 472K-T	B	38/37.9
C480	4030017630	S.CER ECJ0EC1H120J	T	35.6/41.8
C481	4030017360	S.CER ECJ0EC1H030B	T	35.6/43
C501	4030007080	S.CER C1608 CH 1H 390J-T	B	19/42.6
C502	4030007120	S.CER C1608 CH 1H 820J-T	B	18.3/44.1
C503	4030007060	S.CER C1608 CH 1H 270J-T	B	16.1/43.8
C504	4030017780	S.CER ECJ0EB1E472K	T	16.1/49.3
C505	4030017660	S.CER ECJ0EC1H330J	T	12.6/47.2
C506	4030017620	S.CER ECJ0EC1H100C	T	12.1/48.4
C507	4030017500	S.CER ECJ0EC1H560J	T	11.4/47.2
C508	4030017580	S.CER ECJ0EC1H060C	T	10.5/48.4
C509	4030017420	S.CER ECJ0EC1H470J	T	10.2/47.2
C510	4030017350	S.CER ECJ0EC1H020B	T	8.9/47.5
C511	4030017670	S.CER ECJ0EC1H390J	T	7.7/47.2
C512	4030017780	S.CER ECJ0EB1E472K	T	5.5/50.7
C513	4030017780	S.CER ECJ0EB1E472K	T	15.9/46.8
C551	4030017650	S.CER ECJ0EC1H270J	T	22.5/45.4
C552	4030017500	S.CER ECJ0EC1H560J	T	21.1/45
C553	4030017650	S.CER ECJ0EC1H270J	T	19.2/45.4
C554	4030017780	S.CER ECJ0EB1E472K	T	15.6/43.2
C555	4030017670	S.CER ECJ0EC1H390J	T	14.5/42
C556	4030017350	S.CER ECJ0EC1H020B	T	14/43.2
C557	4030017420	S.CER ECJ0EC1H470J	T	13.1/42
C558	4030017590	S.CER ECJ0EC1H070C	T	10/43.2
C559	4030017420	S.CER ECJ0EC1H470J	T	8.9/42
C560	4030017630	S.CER ECJ0EC1H120J	T	8.4/43.2
C561	4030017660	S.CER ECJ0EC1H330J	T	7.9/42
C562	4030017780	S.CER ECJ0EB1E472K	T	4.9/45.3
C563	4030017780	S.CER ECJ0EB1E472K	T	11.7/41.6
C601	4030017780	S.CER ECJ0EB1E472K	T	24.7/39.9
C602	4030017400	S.CER ECJ0EC1H220J	T	23.3/37.6
C603	4030017360	S.CER ECJ0EC1H030B	T	21.9/37.8
C604	4030017630	S.CER ECJ0EC1H120J	T	13.3/40.4
C605	4030017620	S.CER ECJ0EC1H100C	T	11.6/40.4
C606	4030017660	S.CER ECJ0EC1H330J	T	18.4/36.9
C607	4030017600	S.CER ECJ0EC1H080C	T	17.7/38.1
C608	4030017650	S.CER ECJ0EC1H270J	T	17.2/36.9
C609	4030017640	S.CER ECJ0EC1H150J	T	16.1/38.1
C610	4030017640	S.CER ECJ0EC1H150J	T	15.9/36.9
C611	4030017440	S.CER ECJ0EC1H221J	T	12.1/39.5
C612	4030017510	S.CER ECJ0EC1H680J	T	10.2/40
C613	4030017620	S.CER ECJ0EC1H100C	T	8.2/40.1
C614	4030017640	S.CER ECJ0EC1H150J	T	5.4/40.3
C615	4030017670	S.CER ECJ0EC1H390J	T	6.8/39.9
C616	4030017780	S.CER ECJ0EB1E472K	T	6.8/38.2
C617	4030017780	S.CER ECJ0EB1E472K	T	22/36.4
C618	4030017650	S.CER ECJ0EC1H270J	T	3.3/37.1
C651	4030017620	S.CER ECJ0EC1H100C	T	24.6/34.8
C652	4030017450	S.CER ECJ0EB1E271K	T	23.7/34.8
C653	4030017590	S.CER ECJ0EC1H070C	T	21.7/35.2
C654	4030017680	S.CER ECJ0EC1H820J	T	20.4/34.8
C655	4030017600	S.CER ECJ0EC1H080C	T	19.2/35.2
C656	4030017420	S.CER ECJ0EC1H470J	T	17.9/34.8
C657	4030017630	S.CER ECJ0EC1H120J	T	16.5/35.2
C658	4030017340	S.CER ECJ0EC1H010B	T	13.3/32.8
C659	4030017360	S.CER ECJ0EC1H030B	T	9.4/32.6
C660	4030017640	S.CER ECJ0EC1H150J	T	14.6/32.3
C661	4030017650	S.CER ECJ0EC1H270J	T	12.8/31.6
C662	4030017400	S.CER ECJ0EC1H220J	T	8.5/31.6
C663	4030017380	S.CER ECJ0EC1H050B	T	8/32.8
C664	4030017460	S.CER ECJ0EB1E102K	T	5.4/34.9
C665	4030017390	S.CER ECJ0EC1H180J	T	7.6/31.6
C666	4030017780	S.CER ECJ0EB1E472K	T	11.5/31.2
C701	4030017460	S.CER ECJ0EB1E102K	T	25/29.3
C702	4030017640	S.CER ECJ0EC1H150J	T	23.6/27.2
C703	4030017540	S.CER ECJ0EC1HR75B	T	22.2/27.4
C704	4030017650	S.CER ECJ0EC1H270J	T	18.7/26.4
C705	4030017350	S.CER ECJ0EC1H020B	T	18.2/27.7
C706	4030017400	S.CER ECJ0EC1H220J	T	17.5/26.4
C707	4030017570	S.CER ECJ0EC1H040B	T	16.6/27.7
C708	4030017390	S.CER ECJ0EC1H180J	T	16.3/26.4
C709	4030017590	S.CER ECJ0EC1H070C	T	13.9/30
C710	4030017500	S.CER ECJ0EC1H560J	T	12.5/29.1
C711	4030017380	S.CER ECJ0EC1H050B	T	11.9/30
C712	4030017500	S.CER ECJ0EC1H560J	T	10.7/29.3
C713	4030017380	S.CER ECJ0EC1H050B	T	9.5/29.6
C714	4030017710	S.CER ECJ0EC1H181J	T	8.1/29.7
C715	4030017630	S.CER ECJ0EC1H120J	T	6.9/29.3
C716	4030017780	S.CER ECJ0EB1E472K	T	21.5/26
C717	4030017460	S.CER ECJ0EB1E102K	T	5.3/29.3
C751	4030017590	S.CER ECJ0EC1H070C	T	24.8/24.5
C752	4030017710	S.CER ECJ0EC1H181J	T	23.9/24.5
C753	4030017380	S.C		

[DDS UNIT]

REF NO.	PARTS NO.	DESCRIPTION	M.	H/V LOCATION
C761	4030017350	S.CER ECJ0EC1H020B	T	9.7/22.2
C762	4030017630	S.CER ECJ0EC1H120J	T	8.6/21.2
C763	4030017360	S.CER ECJ0EC1H030B	T	8.2/22.4
C764	4030017620	S.CER ECJ0EC1H100C	T	7.7/21.2
C765	4030017460	S.CER ECJ0EB1E102K	T	5.3/24.6
C766	4030017780	S.CER ECJ0EB1E472K	T	11.9/20.8
C802	4030017590	S.CER ECJ0EC1H070C	T	26.5/19.3
C803	4030017380	S.CER ECJ0EC1H050B	T	25.2/18.9
C804	4030017570	S.CER ECJ0EC1H040B	T	24.3/18.9
C806	4030017600	S.CER ECJ0EC1H080C	T	24.3/17.2
C807	4030017360	S.CER ECJ0EC1H030B	T	23.4/18.9
C808	4030017660	S.CER ECJ0EC1H330J	T	23/16.7
C809	4030017570	S.CER ECJ0EC1H040B	T	23/17.6
C810	4030017570	S.CER ECJ0EC1H040B	T	21.7/16.6
C811	4030017590	S.CER ECJ0EC1H070C	T	21.2/17.9
C812	4030017610	S.CER ECJ0EC1H090C	T	20.8/16.6
C813	4030017350	S.CER ECJ0EC1H020B	T	19.7/18.7
C814	4030017580	S.CER ECJ0EC1H060C	T	19.7/17
C815	4030017460	S.CER ECJ0EB1E102K	T	20.3/12.5
C816	4030017460	S.CER ECJ0EB1E102K	T	15.1/10.8
C817	4030017730	S.CER ECJ0EB1E471K	T	19/9
C824	4030017590	S.CER ECJ0EC1H070C	T	13/13
C825	4030017380	S.CER ECJ0EC1H050B	T	14.2/13.4
C826	4030017570	S.CER ECJ0EC1H040B	T	13/15.1
C827	4030017620	S.CER ECJ0EC1H100C	T	14.6/15.5
C828	4030017360	S.CER ECJ0EC1H030B	T	13.9/16.4
C829	4030017660	S.CER ECJ0EC1H330J	T	12.7/16.9
C830	4030017570	S.CER ECJ0EC1H040B	T	11.8/17.6
C831	4030017570	S.CER ECJ0EC1H040B	T	11.8/19.2
C832	4030017590	S.CER ECJ0EC1H070C	T	10.3/19.1
C833	4030017610	S.CER ECJ0EC1H090C	T	8.4/19.1
C834	4030017350	S.CER ECJ0EC1H020B	T	8/17.9
C835	4030017580	S.CER ECJ0EC1H060C	T	7/19.5
C838	4030017460	S.CER ECJ0EB1E102K	T	5.3/19.5
C839	4030017780	S.CER ECJ0EB1E472K	T	25.4/14.5
C840	4030017460	S.CER ECJ0EB1E102K	T	6.5/15.6
C841	4030006860	S.CER C1608 JB 1H 102K-T	B	5.1/15.3
C851	4030017780	S.CER ECJ0EB1E472K	T	4.5/14
C901	4030017780	S.CER ECJ0EB1E472K	T	2.4/68.4
C902	4030017430	S.CER ECJ0EC1H101J	T	16/53.2
C951	4030016930	S.CER ECJ0EB1A104K	T	52.3/38.2
C952	4030011600	S.CER C1608 JB 1E 104K-T	T	58.3/46.9
C953	4030016930	S.CER ECJ0EB1A104K	T	54/18.3
C954	4030017780	S.CER ECJ0EB1E472K	T	54.1/28.1
C955	4030016930	S.CER ECJ0EB1A104K	T	52.8/33.2
C956	4030016930	S.CER ECJ0EB1A104K	T	49.2/21
C957	4030016930	S.CER ECJ0EB1A104K	T	53.8/35.9
C958	4030017780	S.CER ECJ0EB1E472K	T	52.8/34.1
C959	4030017780	S.CER ECJ0EB1E472K	T	52.8/35
C960	4030016930	S.CER ECJ0EB1A104K	T	53.5/38.9
C961	4030016930	S.CER ECJ0EB1A104K	T	52.3/39.8
C962	4030016930	S.CER ECJ0EB1A104K	T	52.3/44.6
C963	4030016930	S.CER ECJ0EB1A104K	T	53.5/38
C964	4030017460	S.CER ECJ0EB1E102K	T	55/44.8
C966	4030016930	S.CER ECJ0EB1A104K	T	52.3/41.4
C967	4030016930	S.CER ECJ0EB1A104K	T	52.3/43
C968	4030018960	S.CER C3216 JB 1C 106MT-N	B	42/43.9
C969	4030006880	S.CER C1608 JB 1H 472K-T	B	48.2/23.1
C972	4030018970	S.CER C3225 JB 1C 226MT-N	B	42.2/3.5
C973	4030018970	S.CER C3225 JB 1C 226MT-N	B	29/2.7
C974	4030018970	S.CER C3225 JB 1C 226MT-N	B	32/2.7
C975	4550007140	S.TAN TEESVD 1C 107M12R	B	16.7/4.1
C976	4550007140	S.TAN TEESVD 1C 107M12R	B	23.5/10.5
C977	4550007140	S.TAN TEESVD 1C 107M12R	B	23.5/19.5
C978	4550007140	S.TAN TEESVD 1C 107M12R	B	32.3/10.5
C980	4030004720	S.CER C2012 JB 1H 102K-T	B	55.5/11
C981	4030016930	S.CER ECJ0EB1A104K	T	54.4/12.5
C982	4030006860	S.CER C1608 JB 1H 102K-T	B	14/67.1
C983	4030006860	S.CER C1608 JB 1H 102K-T	B	7.4/74
C991	4030006860	S.CER C1608 JB 1H 102K-T	B	10/68.1
C992	4030006860	S.CER C1608 JB 1H 102K-T	B	7.2/67.3
C993	4030006860	S.CER C1608 JB 1H 102K-T	B	4.2/74
C994	4030006860	S.CER C1608 JB 1H 102K-T	B	5.6/71.3
C995	4030006860	S.CER C1608 JB 1H 102K-T	B	2.2/59.2
C996	4030006860	S.CER C1608 JB 1H 102K-T	B	5/58.8
C997	4030006860	S.CER C1608 JB 1H 102K-T	B	2.9/55
C998	4030006860	S.CER C1608 JB 1H 102K-T	B	3.1/62.6
C1001	4030011600	S.CER C1608 JB 1E 104K-T	T	58.3/48.4
C1051	4030006880	S.CER C1608 JB 1H 472K-T	B	20.2/65.3
C1052	4030006880	S.CER C1608 JB 1H 472K-T	B	19.2/60.3
C1101	4030017780	S.CER ECJ0EB1E472K	T	38.9/52.1
C1102	4030017780	S.CER ECJ0EB1E472K	T	44.2/50.3
C1104	4030017780	S.CER ECJ0EB1E472K	T	42.2/62.2
C1105	4030017780	S.CER ECJ0EB1E472K	T	40.6/59.9
C1106	4030017780	S.CER ECJ0EB1E472K	T	40.4/55.9
C1107	4030017780	S.CER ECJ0EB1E472K	T	43.3/56.9
C1108	4030017460	S.CER ECJ0EB1E102K	T	40.1/62.2
C1109	4030006880	S.CER C1608 JB 1H 472K-T	B	35.1/76.9
C1110	4030017780	S.CER ECJ0EB1E472K	T	33.5/59.6
C1111	4030017780	S.CER ECJ0EB1E472K	T	29.7/59.6
C1112	4030017780	S.CER ECJ0EB1E472K	T	38.2/63.4
C1113	4030017780	S.CER ECJ0EB1E472K	T	37.1/59.7
C1114	4030017780	S.CER ECJ0EB1E472K	T	24.4/60.6
C1115	4030017780	S.CER ECJ0EB1E472K	T	35.3/59.8
C1116	4030017460	S.CER ECJ0EB1E102K	T	23.1/63.7
C1117	4030006860	S.CER C1608 JB 1H 102K-T	B	20.9/63.9
C1151	4030017780	S.CER ECJ0EB1E472K	T	50.5/66.3
C1152	4030017780	S.CER ECJ0EB1E472K	T	46.4/66.3
C1153	4030017780	S.CER ECJ0EB1E472K	T	43.7/68.2

[DDS UNIT]

REF NO.	PARTS NO.	DESCRIPTION	M.	H/V LOCATION
C1154	4030017780	S.CER ECJ0EB1E472K	T	52/66.3
C1155	4030017780	S.CER ECJ0EB1E472K	T	57.9/68.3
RL1101	6330001721	REL ATN207-K1		
J151	6510007020	CON TMP-J01X-V6		
J851	6510018450	CON TMP-S01X-B1		
J951	6510024880	S.CON 52689-3087	T	59.2/35.3
J952	6510024880	S.CON 52689-3087	T	59.2/12.4
J1001	6510003521	CON S04B-EH-S(LF)(SN)		
J1051	6450001791	CON HLJ7000-016010 2		
J1101	6450001641	CON TCS5044-01411177		
J1151	6450001841	CON TCS7568-4320177		
EP6	6910012350	S.BEA MMZ1608Y 102BT	B	12.9/11
EP251	6910012350	S.BEA MMZ1608Y 102BT	B	33.1/18.7
EP301	6910012350	S.BEA MMZ1608Y 102BT	B	49.7/25
EP302	6910012350	S.BEA MMZ1608Y 102BT	B	32.9/27.8
EP303	6910012350	S.BEA MMZ1608Y 102BT	B	32.9/26.1
EP305	6910012350	S.BEA MMZ1608Y 102BT	B	41/27.1
EP306	6910012350	S.BEA MMZ1608Y 102BT	B	36.6/26.3
			[EUR]	
			[FRA]	
			[ESP]	
			[USA]	
			[EXP]	
			[ITR]	
			[KOR]	
			[AUS]	
			[CHN]	
EP451	6910012350	S.BEA MMZ1608Y 102BT	B	39.9/47.8
EP809	6910012350	S.BEA MMZ1608Y 102BT	B	16.6/7.1
EP951	6910012350	S.BEA MMZ1608Y 102BT	B	53.3/24.3
EP952	6910012350	S.BEA MMZ1608Y 102BT	B	50.5/21.7
EP953	6910012350	S.BEA MMZ1608Y 102BT	T	54/43.4
EP954	6910012350	S.BEA MMZ1608Y 102BT	T	54/42.1
EP955	6910012350	S.BEA MMZ1608Y 102BT	T	54.2/40
EP956	6910012350	S.BEA MMZ1608Y 102BT	T	54.6/37
EP957	6910012350	S.BEA MMZ1608Y 102BT	B	39.5/46.1
EP958	6910012350	S.BEA MMZ1608Y 102BT	B	55.9/47.4
EP959	6910012350	S.BEA MMZ1608Y 102BT	B	56.7/32.5
EP960	6910012350	S.BEA MMZ1608Y 102BT	B	56.9/28.4
EP964	6910012350	S.BEA MMZ1608Y 102BT	B	53.3/22.2
EP981	6910012350	S.BEA MMZ1608Y 102BT	T	55.3/14.2
EP1003	6910018930	S.BEA MPZ2012S601A	T	57.2/50.3
EP1004	6910018930	S.BEA MPZ2012S601A	T	53.9/50
EP1051	6910012350	S.BEA MMZ1608Y 102BT	B	20.2/66.8
EP1052	6910012350	S.BEA MMZ1608Y 102BT	B	19.2/58.7
EP1100	6910012350	S.BEA MMZ1608Y 102BT	B	38.7/63.4
EP1101	6910012350	S.BEA MMZ1608Y 102BT	T	27.5/63.3
EP1102	6910012350	S.BEA MMZ1608Y 102BT	T	34.4/62.4
EP1103	6910012350	S.BEA MMZ1608Y 102BT	T	51.1/69.2
EP1104	6910012350	S.BEA MMZ1608Y 102BT	T	56.1/69.2
EP1105	6910014730	S.BEA MPZ2012S331A-T	B	41/67.9
EP1106	6910014730	S.BEA MPZ2012S331A-T	B	34.7/61.8
EP1107	6910014730	S.BEA MPZ2012S331A-T	B	31.4/61.8
EP1108	6910014730	S.BEA MPZ2012S331A-T	B	27/73.6
MP201	85100017200	PLA 2427 A-SHIELD PLATE Y800	B	43/14.7

M.=Mounted side (T: Mounted on the Top side, B: Mounted on the Bottom side)
S.=Surface mount

The combination of this side and the bottom side shows the board layout in the same configuration as the actual P.C.Board.

• PA UNIT
(BOTTOM VIEW)

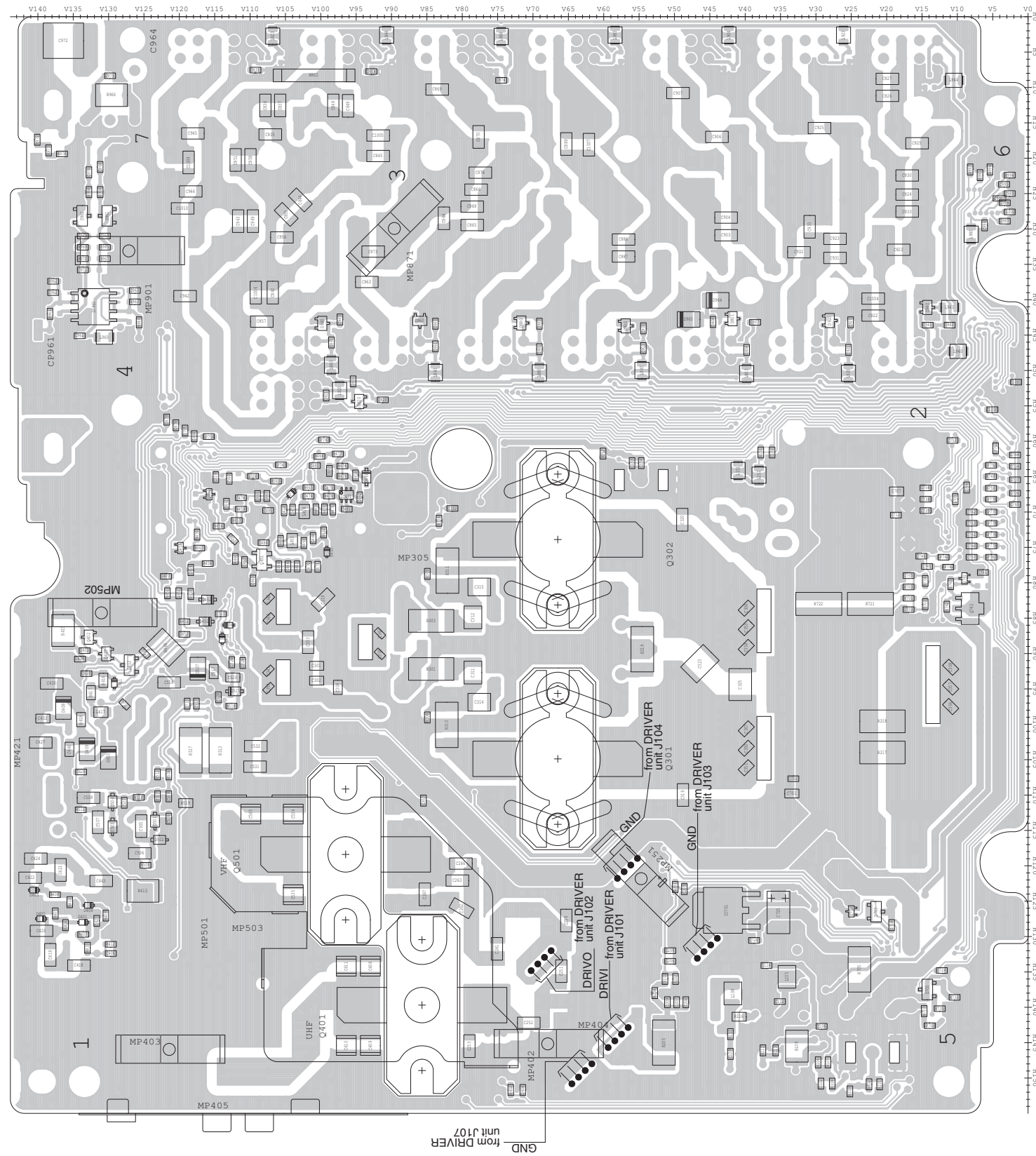

• LOGIC UNIT
(BOTTOM VIEW)

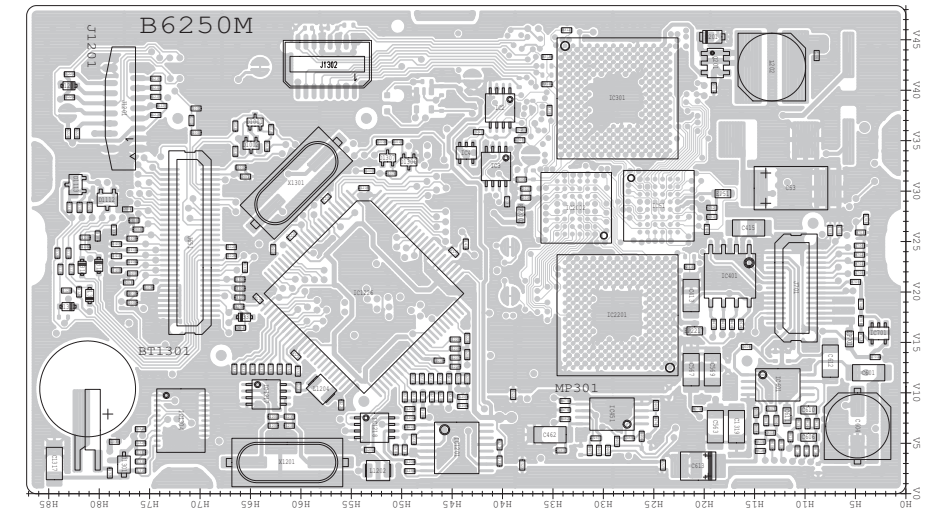

J651

60	1DST	VDL	1
	3DST	MMDK	
	PDT	SQSS	
	PCK	DOTK	
	TCNO	DASK	
	TCN1	WFML	
	PRES#	LTXD	
	LOST	LRXD	
	RS_RXD	CIV	
	RS_TXD	CIVE	
	MST	START	
	MDT	KEY	
	MCK	MUDL	
	NC	FOPL	
	SNDS	REFL	
	SDSS	ALCL	
	2T8V	SNDL	
	4T8V	DPTL	
	TXS	THML	
	RXS	CPU_P12	
	POWS	RTKI	
	VOUT	CPU_P22	
	PWRK	CPU_P94	
	GND	CPU_P95	
	GND	IMR	
	GND	CPU_PF6	
	GND	MMSL	
	GND	NC	
	GND	IMR2	
31	GND	NC	30

to MAIN unit J2252

J701

15	GND	AFMS	16
	DSP02	MOSI	
	GND	SKC	
	DSP01	VSTB	
	GND	NC	
	DOUT	NC	
	GND	NC	
	NC	24M	
	GND	HV	
	GND	8V	
	GND	8V	
	GND	5V	
	DSP1	5V	
	GND	3V	
1	DSP12	3V	30

to MAIN unit J2251

VOLTAGE DIAGRAM

• DISPLAY UNIT

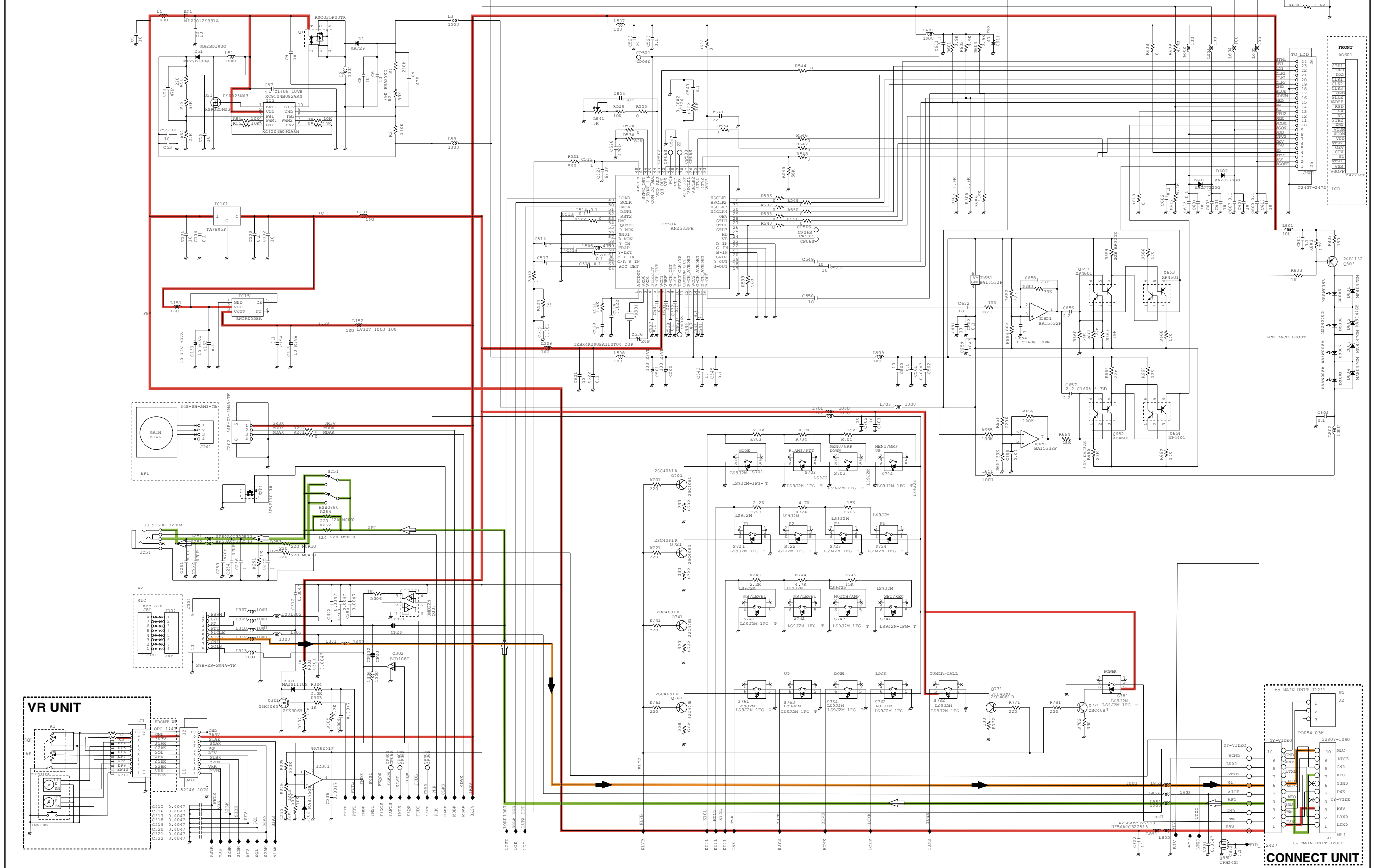

*; Refer to "PARTS LIST."

• LOGIC UNIT (2/3)

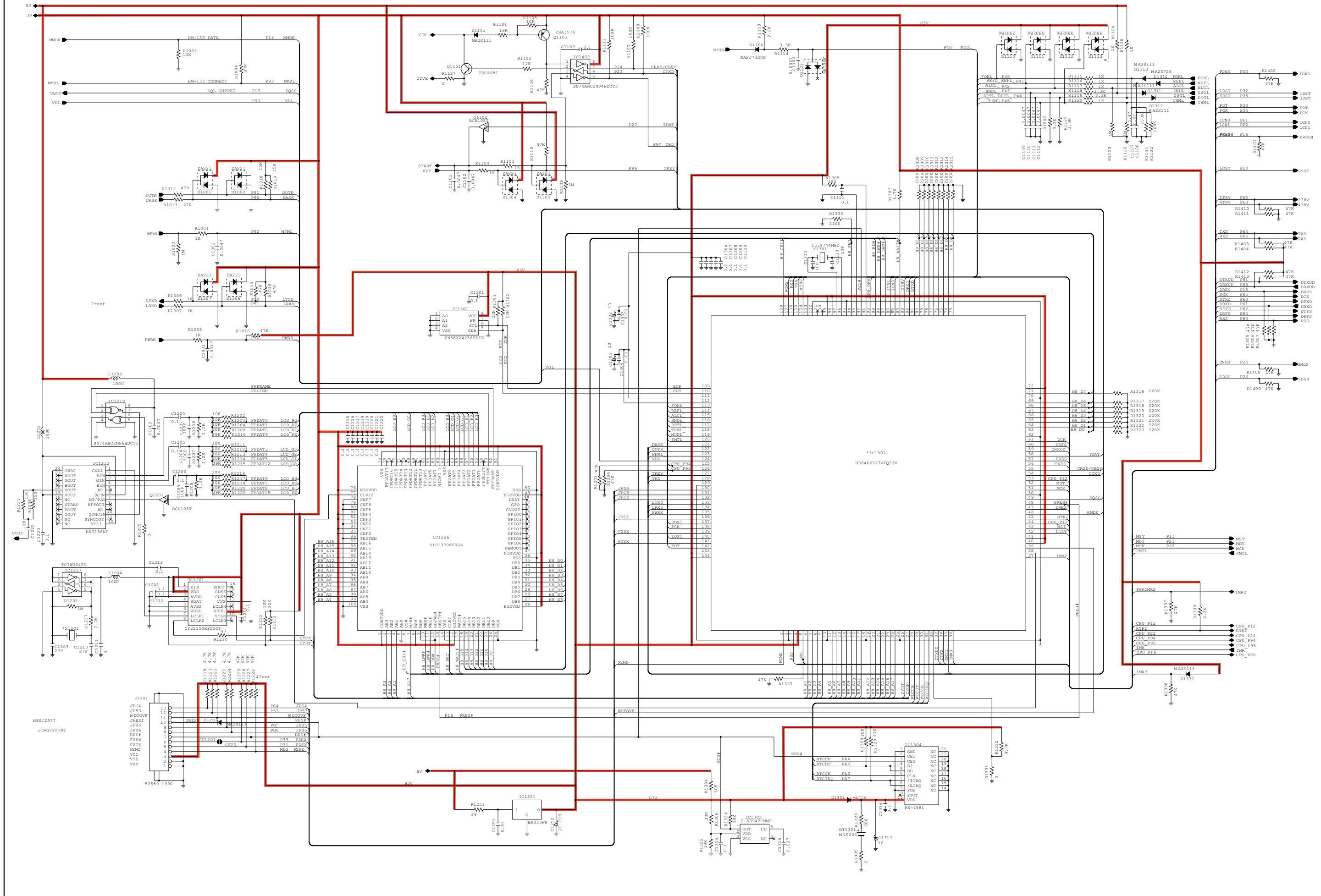

*; Refer to "PARTS LIST."

• LOGIC UNIT (3/3)

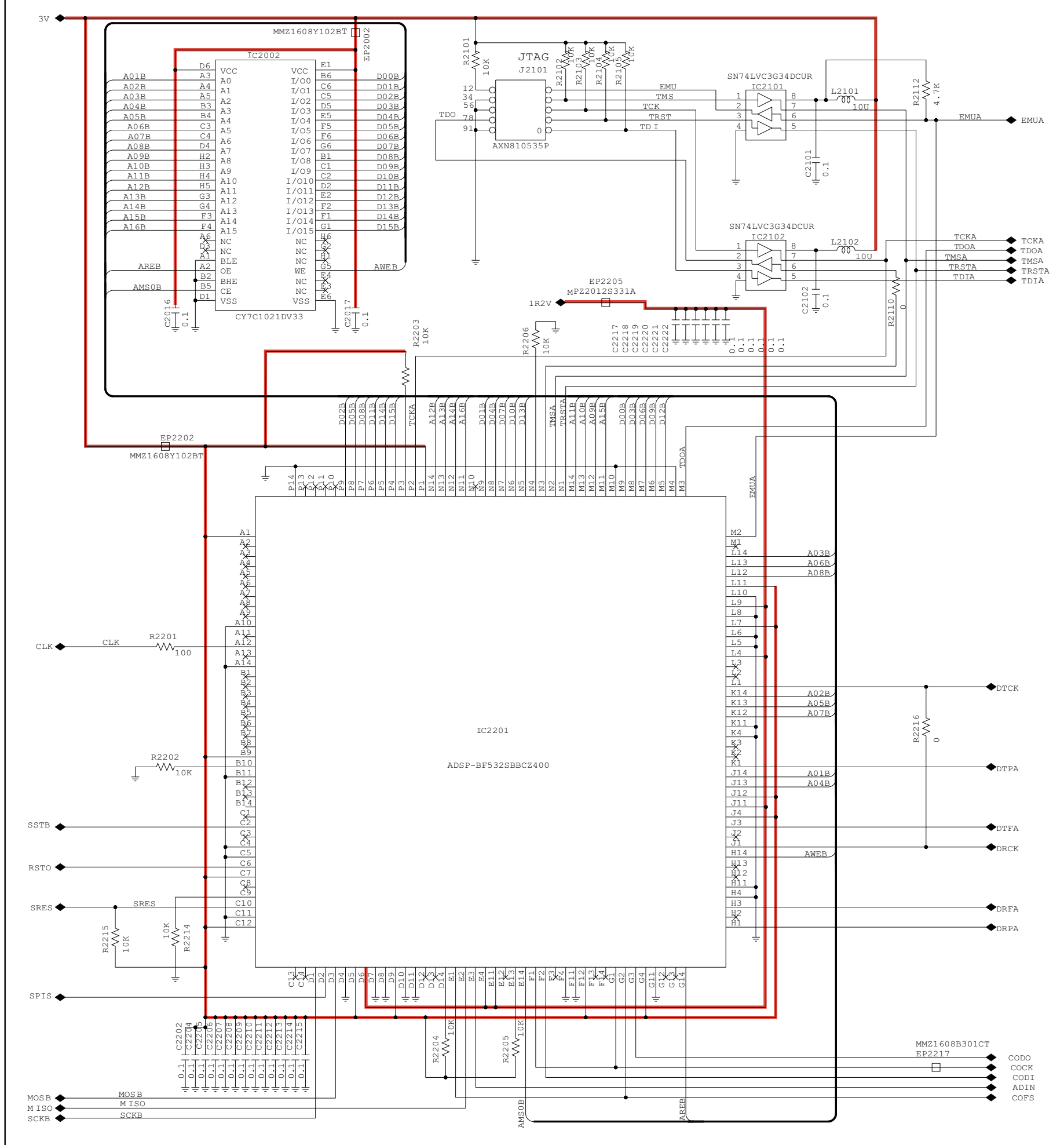

*; Refer to "PARTS LIST."

• MAIN UNIT (Left side)

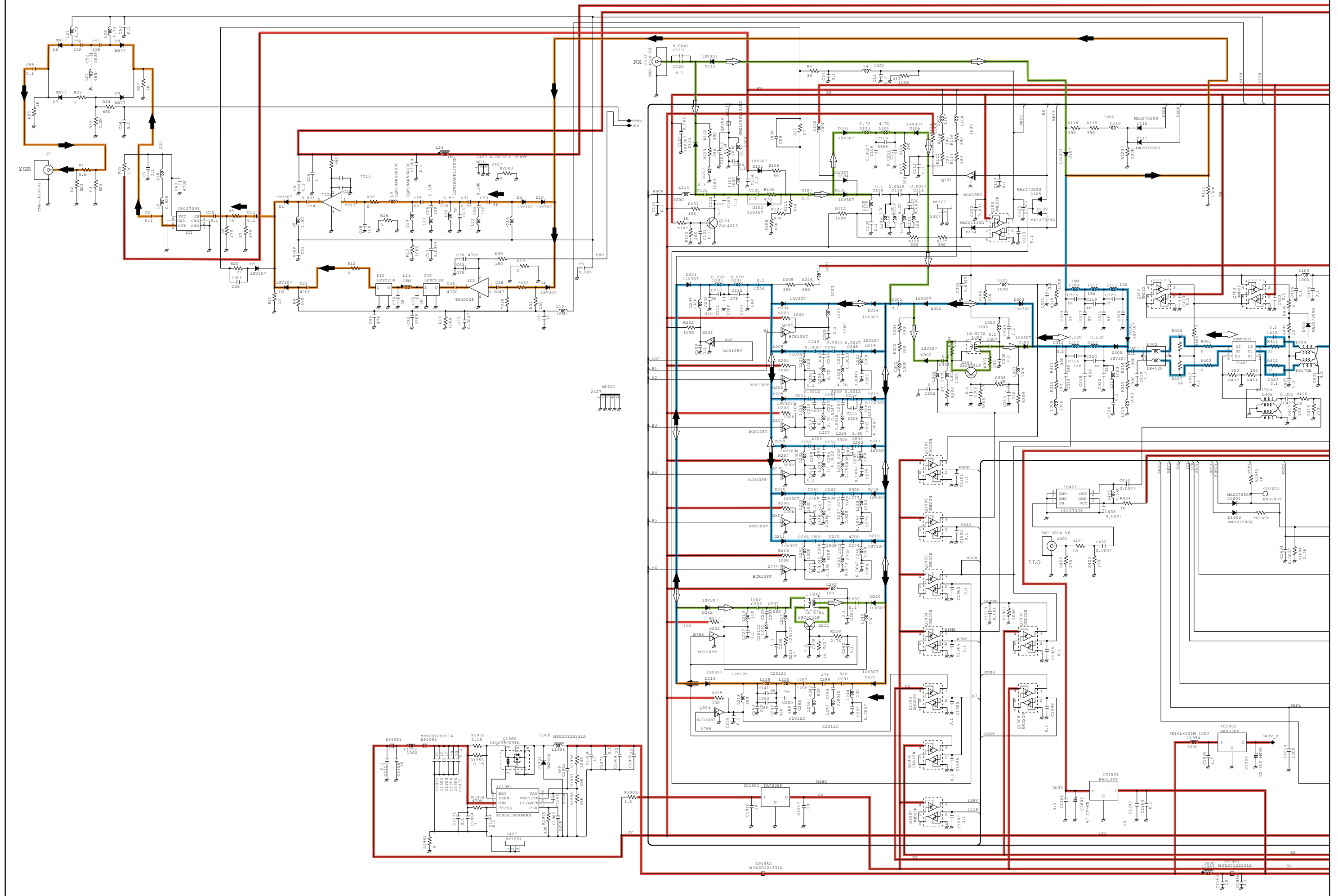

*; Refer to "PARTS LIST."

• PA UNIT (2/2)

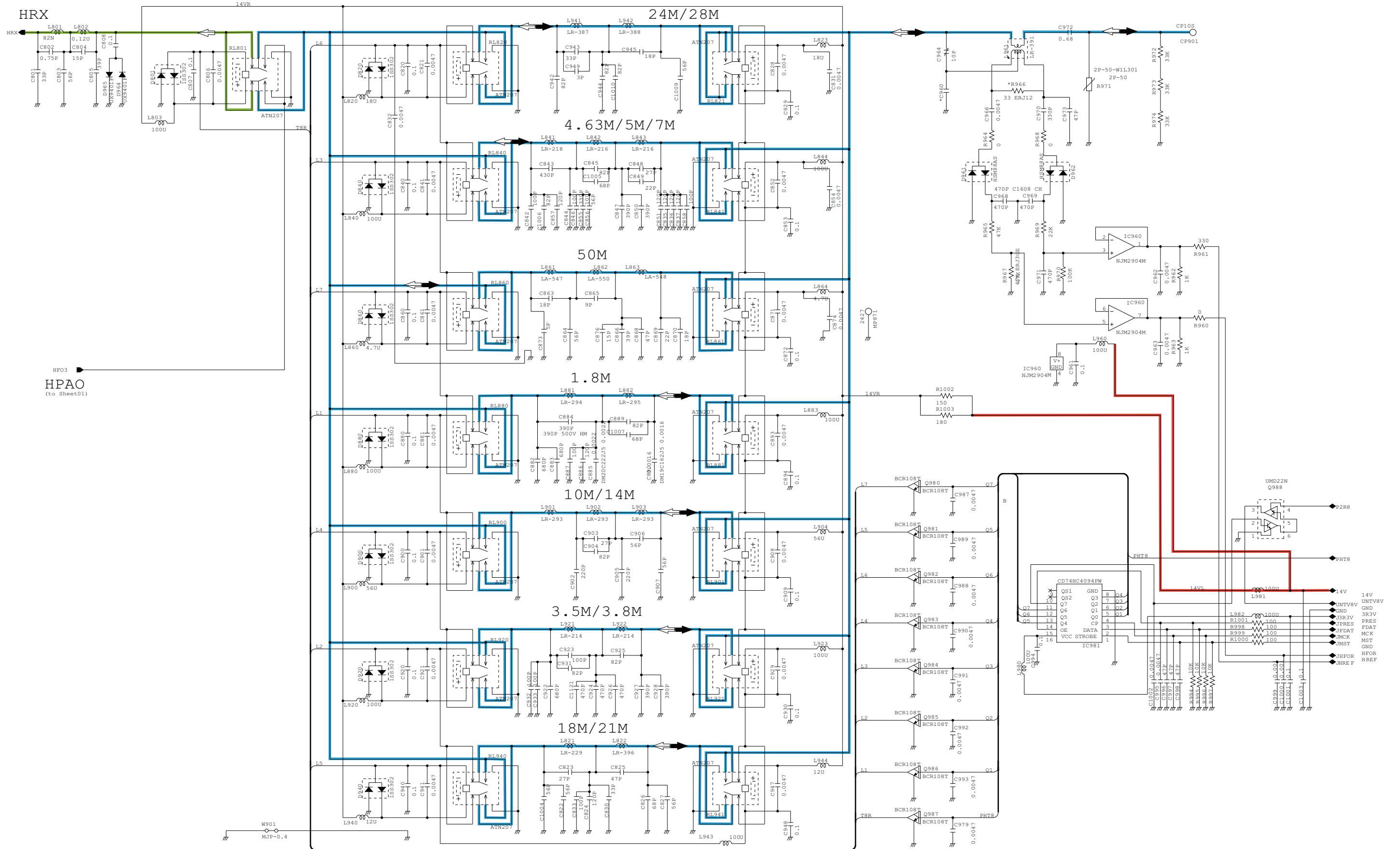

*; Refer to "PARTS LIST."

• DDS UNIT

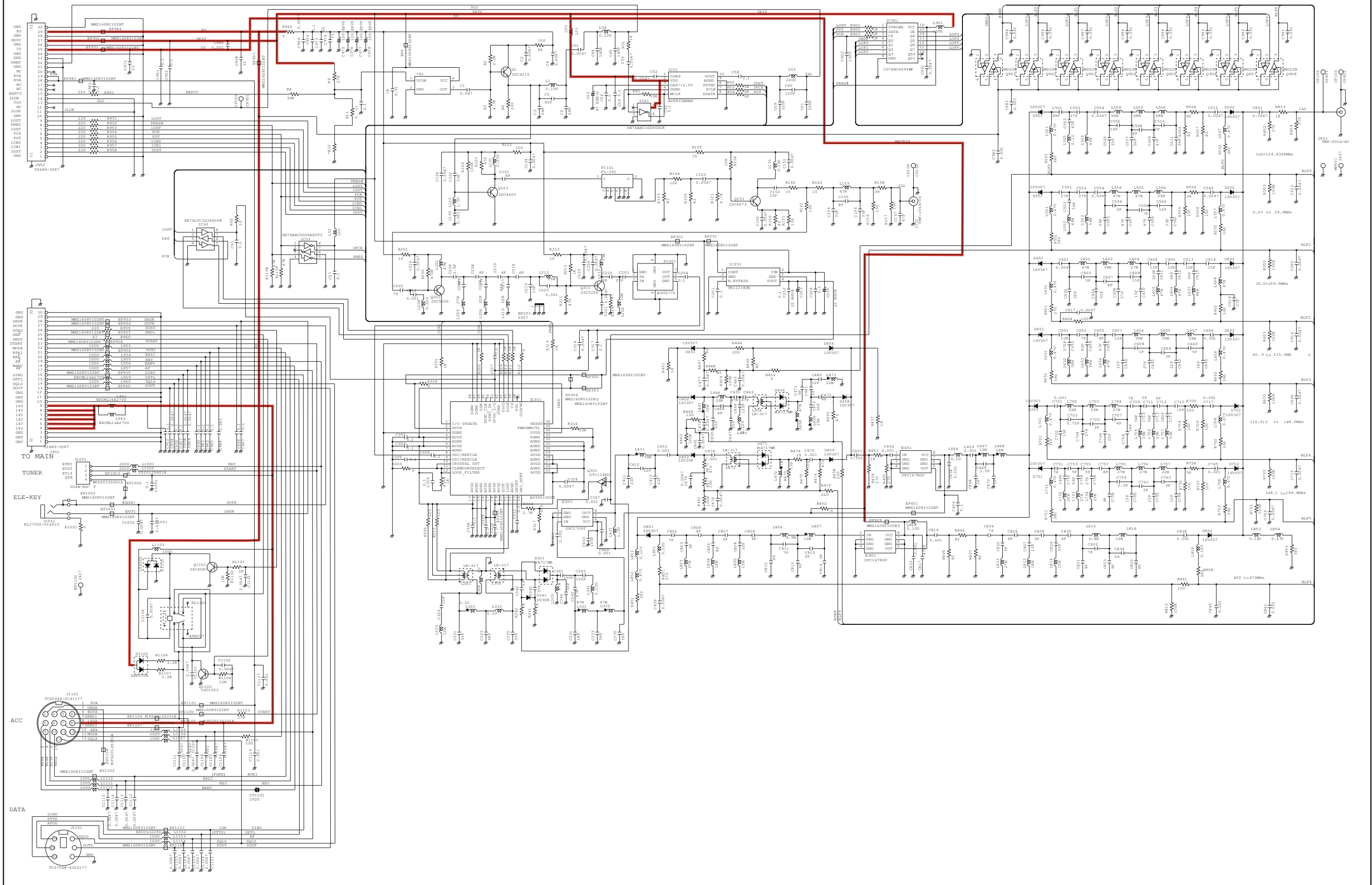

*; Refer to "PARTS LIST."

Oct. 2008



SERVICE MANUAL ADDENDUM

IC-7000

CONTENTS

PARTS LIST	1
BOARD LAYOUTS (LOGIC AND PA UNITS)	26
VOLTAGE DIAGRAM (LOGIC UNIT)	28

PARTS LIST

[MAIN UNIT]

REF NO.	PARTS NO.	DESCRIPTION	M.	H/V LOCATION
IC401	1190002052	S.IC SPM5001-TL-E (7000)2 [EUR]	T	77.5/27.9
	1190002052	S.IC SPM5001-TL-E (7000)2 [ESP]	T	
	1190002052	S.IC SPM5001-TL-E (7000)2 [USA]	T	
	1190002052	S.IC SPM5001-TL-E (7000)2 [EXP]	T	
	1190002052	S.IC SPM5001-TL-E (7000)2 [ITR]	T	
	1190002052	S.IC SPM5001-TL-E (7000)2 [UK]	T	
	1190002052	S.IC SPM5001-TL-E (7000)2 [CHN]	T	
IC1	1110004080	S.IC UPC2709T-E3	T	75.6/12.7
IC2	1110004101	S.IC TA4001F (TE85L,F)	T	64/18.8
IC3	1110004091	S.IC TA4002F (TE85L,F)	T	48.3/17.4
IC401	1190002051	S.IC SPM5001-TL-E 1 [FRA]	T	77.5/27.9
	1190002051	S.IC SPM5001-TL-E 1 [KOR]	T	
	1190002051	S.IC SPM5001-TL-E 1 [AUS]	T	
IC421	1110004080	S.IC UPC2709T-E3	T	86.4/19.4
IC801	1110004080	S.IC UPC2709T-E3	T	86/57.4
IC1101	1110006730	S.IC NJM2594V-TE1-#ZZZB	T	5/83.3
IC1201	1130006221	S.IC TC4W53FU (TE12L,F)	T	24.2/81.6
IC1202	1130006221	S.IC TC4W53FU (TE12L,F)	T	19.8/81.4
IC1203	1110006570	S.IC TS462CPT	T	12.8/81.7
IC1301	1110005461	S.IC TA4107F (TE12L,F)	T	13.7/63.4
IC1401	1110006541	S.IC LA1225M-TLM-E	B	23.4/82.2
IC1501	1110006530	S.IC TA4019F (TE12L,F)	B	74.8/39
IC1502	1110005040	S.IC M52342FP 600C	B	79.7/57
IC1601	1110005320	S.IC NJM13403V-TE1-#ZZZB	T	8.6/41.5
IC1801	1180002020	S.REG BA033FP-E2	B	22.8/106.5
IC1901	1180001251	S.IC TA7808F (TE16L,Q)	B	10.4/55.2
IC1951	1190002120	S.IC XC9201D09AKR	B	41.9/107.8
IC1952	1180002020	S.REG BA033FP-E2	B	14.7/125.8
IC2001	1180001251	S.IC TA7808F (TE16L,Q)	B	8.5/19
IC2007	1110006570	S.IC TS462CPT	T	15.8/121
IC2101	1110005320	S.IC NJM13403V-TE1-#ZZZB	T	28.5/118
IC2102	1110005320	S.IC NJM13403V-TE1-#ZZZB	T	49.5/111.9
IC2103	1110005140	S.IC NJM3403AV-TE1-#ZZZB	T	49.5/121.2
IC2151	1130012720	S.IC CD74HC4094PWR	T	47.1/95.9
IC2152	1130012720	S.IC CD74HC4094PWR	T	37.9/95.9
IC2153	1130012720	S.IC CD74HC4094PWR	T	28.1/95.8
IC2154	1130012720	S.IC CD74HC4094PWR	T	28.2/101.5
IC2155	1110006680	S.IC BH2211FV-E2	T	38.2/118.1
IC2156	1130009100	S.IC BU4052BCFV-E2	T	10.1/107.6
IC2231	1110006640	S.IC NJM2244M-TE1-#ZZZB	T	34.7/109.4
IC2251	1130008511	S.IC TC7W53FU (TE12L,F)	T	16.7/89.5
IC2501	1110006570	S.IC TS462CPT	B	12.7/91.7
IC2551	1110006570	S.IC TS462CPT	B	49.2/122
IC2601	1130006221	S.IC TC4W53FU (TE12L,F)	B	63.2/123.9
IC2602	1110003091	IC LA4425A-E		
Q101	1530003091	S.TRA 2SC4213-B (TE85R,F)	T	11.2/17.5
Q102	1590003940	S.TRA RN1105 (TE85L,F)	T	20.7/5.6
Q103	1590003930	S.TRA UMD22N TR	T	38.4/20.2
Q201	1590003940	S.TRA RN1105 (TE85L,F)	T	16.1/31.1
Q202	1590003940	S.TRA RN1105 (TE85L,F)	T	23.5/28.5
Q204	1590003940	S.TRA RN1105 (TE85L,F)	B	44.7/38.6
Q205	1590003940	S.TRA RN1105 (TE85L,F)	T	42.9/61.5
Q206	1590003940	S.TRA RN1105 (TE85L,F)	B	24.5/55
Q207	1590003940	S.TRA RN1105 (TE85L,F)	B	24.5/51.9
Q208	1590003940	S.TRA RN1105 (TE85L,F)	B	24.2/48.8
Q209	1590003940	S.TRA RN1105 (TE85L,F)	B	23.5/45.7
Q210	1590003940	S.TRA RN1105 (TE85L,F)	B	42.9/41.4
Q211	1530003851	S.TRA 2SC5551F-TD-E 0	T	27.6/30.1
Q301	1530003851	S.TRA 2SC5551F-TD-E 0	T	56.7/32.4
Q402	1590003930	S.TRA UMD22N TR	T	82.8/22.8
Q403	1590003930	S.TRA UMD22N TR	T	69.7/23.6
Q502	1530003851	S.TRA 2SC5551F-TD-E 0	T	83/37.1
Q701	1580000780	S.FET 3SK195 (TE85L,F)	T	62/56.5
Q702	1580000780	S.FET 3SK195 (TE85L,F)	T	54.6/51.8
Q901	1580000780	S.FET 3SK195 (TE85L,F)	T	36.6/65.7
Q902	1580000780	S.FET 3SK195 (TE85L,F)	T	35.9/73.2
Q1001	1580000780	S.FET 3SK195 (TE85L,F)	T	17.9/76
Q1201	1590003930	S.TRA UMD22N TR	T	28/78.6
Q1401	1530002060	S.TRA 2SC4081 T106 R	B	42.5/74.3
Q1402	1530002060	S.TRA 2SC4081 T106 R	B	36.7/80.1
Q1501	1590003530	S.TRA BCR08PN 0	T	30.6/78.5
Q1521	1530002060	S.TRA 2SC4081 T106 R	B	86.6/48.6
Q1601	1530003091	S.TRA 2SC4213-B (TE85R,F)	T	8.3/52.9
Q1602	1590001870	S.TRA DTA114EE TL	T	4.5/53
Q1603	1590003940	S.TRA RN1105 (TE85L,F)	T	2.8/40.7
Q1604	1510000771	S.TRA 2SA1586-GR (TE85L,F)	T	5.1/32.7
Q1606	1560001260	S.FET 2SK3018 T106	T	12.5/36.8
Q1701	1540000441	S.TRA 2SD1619T-TD-E	B	52.4/48.2
Q1702	1590003940	S.TRA RN1105 (TE85L,F)	B	54.3/52.1
Q1703	1540000441	S.TRA 2SD1619T-TD-E	B	52.4/67.4
Q1704	1590003940	S.TRA RN1105 (TE85L,F)	B	54.1/72.9
Q1901	1590003930	S.TRA UMD22N TR	T	35.8/78.5
Q1902	1590003930	S.TRA UMD22N TR	T	33.3/78.5
Q1903	1590003930	S.TRA UMD22N TR	B	23.6/17
Q1904	1590003930	S.TRA UMD22N TR	B	32.9/87.9
Q1905	1590003930	S.TRA UMD22N TR	B	46/40.9
Q1906	1590003930	S.TRA UMD22N TR	B	26.3/30.8
Q1907	1590003930	S.TRA UMD22N TR	T	40.9/78.5
Q1908	1590003930	S.TRA UMD22N TR	T	38.3/78.5
Q1909	1590003930	S.TRA UMD22N TR	B	22.1/11.8
Q1960	1550000090	S.FET RSQ035P03TR	B	37.9/103.6

[MAIN UNIT]

REF NO.	PARTS NO.	DESCRIPTION	M.	H/V LOCATION
Q2150	1590003930	S.TRA UMD22N TR	T	48.4/100.1
Q2151	1520000460	S.TRA 2SB1132 T100 R	T	55.3/103.8
Q2152	1520000460	S.TRA 2SB1132 T100 R	T	21.3/111
Q2153	1520000460	S.TRA 2SB1132 T100 R	T	49.8/104.5
Q2154	1590003930	S.TRA UMD22N TR	T	44.7/100.1
Q2155	1590003930	S.TRA UMD22N TR	T	39.9/100.1
Q2156	1590003940	S.TRA RN1105 (TE85L,F)	T	58.9/104.5
Q2157	1590003940	S.TRA RN1105 (TE85L,F)	T	25.4/109.7
Q2158	1590003940	S.TRA RN1105 (TE85L,F)	T	45.5/107.1
Q2159	1590003930	S.TRA UMD22N TR	T	6.7/118.2
Q2160	1590003930	S.TRA UMD22N TR	T	7.7/122.2
Q2231	1590003940	S.TRA RN1105 (TE85L,F)	T	4.7/121.7
Q2232	1590003930	S.TRA UMD22N TR	T	57.3/114.8
Q2233	1590003930	S.TRA UMD22N TR	T	54.7/115.7
Q2301	1530002060	S.TRA 2SC4081 T106 R	T	30.6/109
Q2401	1540000441	S.TRA 2SD1619T-TD-E	B	80.1/26.4
Q2601	1560001260	S.FET 2SK3018 T106	B	36.2/124.6
Q2602	1560001221	S.FET ECH8301-TL-E	B	37.3/127.6
Q2603	1530002060	S.TRA 2SC4081 T106 R	T	65.3/111.3
Q2605	1590003940	S.TRA RN1105 (TE85L,F)	T	11.7/112.7
Q2606	1540000451	S.TRA 2SD1623T-TD-E	B	89.5/119.9
Q2607	1590003940	S.TRA RN1105 (TE85L,F)	B	65.4/120.5
Q2608	1590003940	S.TRA RN1105 (TE85L,F)	B	45/128.6
D1	1750000581	S.DIO 1SV307 (TPH3,F)	T	70.1/16.6
D2	1750000581	S.DIO 1SV307 (TPH3,F)	T	70.3/14.8
D3	1750000581	S.DIO 1SV307 (TPH3,F)	T	45.2/19.8
D4	1750000581	S.DIO 1SV307 (TPH3,F)	T	41.9/19
D5	1750000581	S.DIO 1SV307 (TPH3,F)	T	70.3/18.3
D6	1790000620	S.DIO MA77 (TX) 0	B	79.8/17.1
D7	1790000620	S.DIO MA77 (TX) 0	T	78/15.8
D8	1790000620	S.DIO MA77 (TX) 0	B	81.5/10.6
D9	1790000620	S.DIO MA77 (TX) 0	T	79/11.5
D10	1750000581	S.DIO 1SV307 (TPH3,F)	T	42.4/20.9
D101	1750000581	S.DIO 1SV307 (TPH3,F)	T	13.3/25.5
D102	1750000581	S.DIO 1SV307 (TPH3,F)	T	15.7/19.2
D103	1750000581	S.DIO 1SV307 (TPH3,F)	T	20.3/8.7
D104	1750000581	S.DIO 1SV307 (TPH3,F)	T	34.7/17.9
D105	1750000581	S.DIO 1SV307 (TPH3,F)	T	23.1/12.7
D106	1750000581	S.DIO 1SV307 (TPH3,F)	T	29.6/21
D107	1750000581	S.DIO 1SV307 (TPH3,F)	T	44/23.6
D108	1750000950	S.DIO MA732 (TX)	B	27.1/18.2
D109	1750000950	S.DIO MA732 (TX)	B	24.7/20.3
D110	1790001240	S.DIO MA2S728-(TX)	B	51.6/26.4
D111	1790001240	S.DIO MA2S728-(TX)	B	51.6/24.7
D112	1750000581	S.DIO 1SV307 (TPH3,F)	T	15.7/20.9
D113	1750000581	S.DIO 1SV307 (TPH3,F)	T	10.2/19.7
D114	1790001250	S.DIO MA2S111-(TX)	T	35.7/21.3
D203	1750000581	S.DIO 1SV307 (TPH3,F)	T	19.3/35.7
D204	1750000581	S.DIO 1SV307 (TPH3,F)	T	25.7/58.2
D205	1750000581	S.DIO 1SV307 (TPH3,F)	T	25.7/56.3
D208	1750000581	S.DIO 1SV307 (TPH3,F)	T	25.7/53.4
D209	1750000581	S.DIO 1SV307 (TPH3,F)	T	25.7/50.6
D210	1750000581	S.DIO 1SV307 (TPH3,F)	T	25.7/47.7
D211	1750000581	S.DIO 1SV307 (TPH3,F)	T	25.7/44.8
D212	1750000581	S.DIO 1SV307 (TPH3,F)	T	25.7/39.2
D213	1750000581	S.DIO 1SV307 (TPH3,F)	T	25.7/41.5
D214	1750000581	S.DIO 1SV307 (TPH3,F)	T	47.7/59.3
D215	1750000581	S.DIO 1SV307 (TPH3,F)	T	47.7/56.3
D216	1750000581	S.DIO 1SV307 (TPH3,F)	T	47.9/53.6
D217	1750000581	S.DIO 1SV307 (TPH3,F)	T	47.8/49.7
D218	1750000581	S.DIO 1SV307 (TPH3,F)	B	41.7/47.2
D219	1750000581	S.DIO 1SV307 (TPH3,F)	B	38.9/41.6
D220	1750000581	S.DIO 1SV307 (TPH3,F)	B	44.6/28.5
D221	1750000581	S.DIO 1SV307 (TPH3,F)	B	40.4/36
D301	1750000581	S.DIO 1SV307 (TPH3,F)	T	47.3/28.5
D302	1750000581	S.DIO 1SV307 (TPH3,F)	T	49.5/30.3
D303	1750000581	S.DIO 1SV307 (TPH3,F)	T	64.1/29.9
D304	1750000581	S.DIO 1SV307 (TPH3,F)	T	62.4/35.2
D305	1750000581	S.DIO 1SV307 (TPH3,F)	T	73.3/35.2
D306	1750000581	S.DIO 1SV307 (TPH3,F)	T	64.5/25.7
D401	1790001240	S.DIO MA2S728-(TX)	T	86.6/24.9
D501	1750000531	S.DIO 1SV271 (TPH3,F)	T	90.6/32.2
D502	1750000581	S.DIO 1SV307 (TPH3,F)	T	86.2/31.4
D503	1750000581	S.DIO 1SV307 (TPH3,F)	T	89.4/29.7
D504	1750000531	S.DIO 1SV271 (TPH3,F)	T	89.7/37.7
D505	1750000581	S.DIO 1SV307 (TPH3,F)	T	86.7/40.1
D506	1750000581	S.DIO 1SV307 (TPH3,F)	B	87.2/35.5
D601	1750000581	S.DIO 1SV307 (TPH3,F)	B	90/38.5
D602	1750000581			

[MAIN UNIT]

REF NO.	PARTS NO.	DESCRIPTION	M.	H/V LOCATION
D1302	1750000581	S.DIO 1SV307(TPH3,F)	T	13.9/70.8
D1521	1750000531	S.DIO 1SV271(TPH3,F)	B	79.4/40.7
D1522	1750000531	S.DIO 1SV271(TPH3,F)	B	79.4/42.4
D1601	1790001240	S.DIO MA2S728-(TX)	T	15.1/48.7
D1602	1790001240	S.DIO MA2S728-(TX)	T	18.3/53.1
D1604	1790001250	S.DIO MA2S111-(TX)	T	7.7/31.5
D1605	1790001250	S.DIO MA2S111-(TX)	T	7.7/32.8
D1606	1790001250	S.DIO MA2S111-(TX)	T	14.1/44.8
D1607	1790001250	S.DIO MA2S111-(TX)	T	14.1/43.5
D1608	1790001250	S.DIO MA2S111-(TX)	T	14.1/42.2
D1609	1790001330	S.ZEN MA8036-L(TX)	T	7.5/29.9
D1610	1790001250	S.DIO MA2S111-(TX)	T	12.3/34.9
D1701	1790001670	S.DIO RB706F-40T106	B	50.2/52.2
D1702	1790001670	S.DIO RB706F-40T106	B	51.8/71.8
D1951	1750001110	S.DIO SM240A-T	B	36.2/99.9
D2151	1790001250	S.DIO MA2S111-(TX) [USA]	T	39/87.1
	1790001250	S.DIO MA2S111-(TX) [KOR]		
	1790001250	S.DIO MA2S111-(TX) [AUS]		
D2153	1790001250	S.DIO MA2S111-(TX) [USA]	T	36.5/87.1
	1790001250	S.DIO MA2S111-(TX) [KOR]		
D2154	1790001250	S.DIO MA2S111-(TX)	T	36.5/88.4
D2155	1790001250	S.DIO MA2S111-(TX)	T	36.6/89.7
D2156	1790001250	S.DIO MA2S111-(TX)	T	39/90.5
D2157	1790001250	S.DIO MA2S111-(TX) [EUR]	T	48.5/87.1
	1790001250	S.DIO MA2S111-(TX) [ESP]		
	1790001250	S.DIO MA2S111-(TX) [USA]		
	1790001250	S.DIO MA2S111-(TX) [EXP]		
	1790001250	S.DIO MA2S111-(TX) [ITR]		
	1790001250	S.DIO MA2S111-(TX) [UK]		
	1790001250	S.DIO MA2S111-(TX) [KOR]		
	1790001250	S.DIO MA2S111-(TX) [AUS]		
	1790001250	S.DIO MA2S111-(TX) [CHN]		
D2158	1790001250	S.DIO MA2S111-(TX)	T	48.5/88.4
D2159	1790001250	S.DIO MA2S111-(TX)	T	48.5/89.7
D2160	1790001250	S.DIO MA2S111-(TX)	T	48.5/91
D2162	1790001250	S.DIO MA2S111-(TX) [USA] only	T	46/88.4
D2163	1790001250	S.DIO MA2S111-(TX) [EUR]	T	46/89.7
	1790001250	S.DIO MA2S111-(TX) [FRA]		
	1790001250	S.DIO MA2S111-(TX) [ESP]		
	1790001250	S.DIO MA2S111-(TX) [ITR]		
	1790001250	S.DIO MA2S111-(TX) [UK]		
D2166	1790001250	S.DIO MA2S111-(TX) [ESP]	T	29.4/88.2
	1790001250	S.DIO MA2S111-(TX) [ITR]		
	1790001250	S.DIO MA2S111-(TX) [KOR]		
D2168	1790001250	S.DIO MA2S111-(TX) [EUR]	T	29.4/90.6
	1790001250	S.DIO MA2S111-(TX) [ESP]		
	1790001250	S.DIO MA2S111-(TX) [ITR]		
	1790001250	S.DIO MA2S111-(TX) [UK]		
	1790001250	S.DIO MA2S111-(TX) [AUS]		
D2169	1790001250	S.DIO MA2S111-(TX) [EUR]	T	26.9/87.1
	1790001250	S.DIO MA2S111-(TX) [ESP]		
	1790001250	S.DIO MA2S111-(TX) [USA]		
	1790001250	S.DIO MA2S111-(TX) [EXP]		
	1790001250	S.DIO MA2S111-(TX) [ITR]		
	1790001250	S.DIO MA2S111-(TX) [UK]		
	1790001250	S.DIO MA2S111-(TX) [KOR]		
	1790001250	S.DIO MA2S111-(TX) [CHN]		
D2170	1790001250	S.DIO MA2S111-(TX) [EUR]	T	26.9/88.4
	1790001250	S.DIO MA2S111-(TX) [USA]		
	1790001250	S.DIO MA2S111-(TX) [EXP]		
	1790001250	S.DIO MA2S111-(TX) [UK]		
	1790001250	S.DIO MA2S111-(TX) [AUS]		
	1790001250	S.DIO MA2S111-(TX) [KOR]		
	1790001250	S.DIO MA2S111-(TX) [CHN]		
D2171	1790001250	S.DIO MA2S111-(TX) [FRA]	T	26.9/89.7
	1790001250	S.DIO MA2S111-(TX) [ESP]		
	1790001250	S.DIO MA2S111-(TX) [EXP]		
	1790001250	S.DIO MA2S111-(TX) [UK]		
	1790001250	S.DIO MA2S111-(TX) [AUS]		
	1790001250	S.DIO MA2S111-(TX) [CHN]		
D2172	1790001250	S.DIO MA2S111-(TX)	T	26.9/91
D2173	1790001250	S.DIO MA2S111-(TX)	T	6.4/120.2
D2174	1790001250	S.DIO MA2S111-(TX)	T	52/88.2
D2175	1790001250	S.DIO MA2S111-(TX)	T	52/87
D2201	1730002340	S.ZEN MA8047-M(TX)	T	10.5/122.8
D2205	1790001010	S.ZEN MA8043-L(TX)	T	13.5/115.2
D2211	1790001010	S.ZEN MA8043-L(TX)	T	21.5/118
D2231	1160000070	S.DIO DAN202K T146	T	57.6/117.8
D2232	1790001670	S.DIO RB706F-40T106	T	56.8/112.2
D2401	1160000070	S.DIO DAN202K T146	B	85.7/27.2
D2402	1790001250	S.DIO MA2S111-(TX)	T	63.5/113.2
D2551	1790001140	S.ZEN MA8039-L(TX)	B	45.3/116.5
D2601	1160000070	S.DIO DAN202K T146	B	42/126.3
D2602	1790001250	S.DIO MA2S111-(TX)	B	41.2/128.5
FI2	2040001420	S.LC LFB32440MSC1-955 (LFSC25N12B0)	T	59.3/13.9
FI3	2040001420	S.LC LFB32440MSC1-955 (LFSC25N12B0)	T	53.3/13.4
FI601	2010002640	S.XTA DSF753SDF 124.487 MHz (FL-374)	T	81/43.7
FI901	2020002011	S.CER CFUKG455KF4A-R0	T	44.7/69.7
FI1001	2020002011	S.CER CFUKG455KF4A-R0	T	27.8/66.9
FI1401	2020001810	S.CER SFECV10M7FA00-R0 (SFECV10.7MA5S)	B	37.5/76.4
FI1402	2020001810	S.CER SFECV10M7FA00-R0 (SFECV10.7MA5S)	B	29.5/77.5
FI1501	2040001561	SAW TSB6321DL [EUR]		
	2040001561	SAW TSB6321DL [FRA]		
	2040001561	SAW TSB6321DL [ESP]		

[MAIN UNIT]

REF NO.	PARTS NO.	DESCRIPTION	M.	H/V LOCATION
FI1501	2040001571	SAW TSB6221DL [USA]		
	2040001561	SAW TSB6321DL [EXP]		
	2040001561	SAW TSB6321DL [ITR]		
	2040001561	SAW TSB6321DL [UK]		
	2040001571	SAW TSB6221DL [KOR]		
	2040001561	SAW TSB6321DL [AUS]		
	2040001561	SAW TSB6321DL [CHN]		
FI1502	2020001720	S.CER SFSKA5M50CF00-R1 (SFSCC5.5MC2-T) [EUR]	B	69.3/57.8
	2020001720	S.CER SFSKA5M50CF00-R1 (SFSCC5.5MC2-T) [FRA]		
	2020001720	S.CER SFSKA5M50CF00-R1 (SFSCC5.5MC2-T) [ESP]		
	2020001700	S.CER SFSKA4M50CF00-R1 (SFSCC4.5MC2-T) [USA]		
	2020001720	S.CER SFSKA5M50CF00-R1 (SFSCC5.5MC2-T) [EXP]		
	2020001720	S.CER SFSKA5M50CF00-R1 (SFSCC5.5MC2-T) [ITR]		
	2020001720	S.CER SFSKA5M50CF00-R1 (SFSCC5.5MC2-T) [UK]		
	2020001700	S.CER SFSKA4M50CF00-R1 (SFSCC4.5MC2-T) [KOR]		
	2020001720	S.CER SFSKA5M50CF00-R1 (SFSCC5.5MC2-T) [AUS]		
	2020001720	S.CER SFSKA5M50CF00-R1 (SFSCC5.5MC2-T) [CHN]		
FI1503	2020001730	S.CER TPSKA5M50B00-R1 (TPSCC5.5MB-TC1) [EUR]	B	73.5/78.7
	2020001730	S.CER TPSKA5M50B00-R1 (TPSCC5.5MB-TC1) [FRA]		
	2020001730	S.CER TPSKA5M50B00-R1 (TPSCC5.5MB-TC1) [ESP]		
	2020001710	S.CER TPSKA4M50B00-R1 (TPSCC4.5MO-TC1) [USA]		
	2020001730	S.CER TPSKA5M50B00-R1 (TPSCC5.5MB-TC1) [EXP]		
	2020001730	S.CER TPSKA5M50B00-R1 (TPSCC5.5MB-TC1) [ITR]		
	2020001730	S.CER TPSKA5M50B00-R1 (TPSCC5.5MB-TC1) [UK]		
	2020001710	S.CER TPSKA4M50B00-R1 (TPSCC4.5MO-TC1) [KOR]		
	2020001730	S.CER TPSKA5M50B00-R1 (TPSCC5.5MB-TC1) [AUS]		
	2020001730	S.CER TPSKA5M50B00-R1 (TPSCC5.5MB-TC1) [CHN]		
L3	6200004480	S.COI MLF1608D R82K-T	T	76.4/10.1
L4	6200002041	S.COI NLV25T-101J	T	75.6/18.9
L5	6200004780	S.COI MLF1608A 1R5K-T	T	67.4/18.6
L7	6200011320	COI ELJQE 56NJ 2 [AUS] only		
L8	6200010910	S.COI LQW18AN56NG00D	T	57/16.6
L10	6200010910	S.COI LQW18AN56NG00D	T	57.3/17.9
L11	6200011780	S.COI LQW18ANR18G00D	T	56.5/20
L12	6200011680	S.COI LQW18ANR12G00D	T	53.8/19.8
L13	6200011780	S.COI LQW18ANR18G00D	T	52.8/18.5
L14	6200009590	S.COI MLG1608B 18NJ-T	T	57.3/11.4
L16	6200005721	S.COI ELJRE 33NGFA [EUR]	T	49.6/19.8
	6200005721	S.COI ELJRE 33NGFA [FRA]		
	6200005721	S.COI ELJRE 33NGFA [ESP]		
	6200005721	S.COI ELJRE 33NGFA [USA]		
	6200005721	S.COI ELJRE 33NGFA [EXP]		
	6200005721	S.COI ELJRE 33NGFA [ITR]		
	6200006991	S.COI ELJRE 56NGFA [UK]		
	6200005721	S.COI ELJRE 33NGFA [KOR]		
	6200005721	S.COI ELJRE 33NGFA [AUS]		
	6200005721	S.COI ELJRE 33NGFA [CHN]		
L18	6200005041	S.COI NLV25T-220J	T	73.4/9.5
L19	6200002041	S.COI NLV25T-101J	T	66.9/14.8
L21	6200006671	S.COI ELJRE 68NGFA	B	80.4/14.6
L22	6200002861	S.COI NLV25T-4R7J	B	79.7/20.2
L23	6200002861	S.COI NLV25T-4R7J	B	84/9.2
L24	6200011520	S.COI SLF7045T-102MR14-PF	B	8.8/69
L101	6200002041	S.COI NLV25T-101J	T	15.7/17
L102	6200002041	S.COI NLV25T-101J	T	20.4/10.9
L103	6200010800	S.COI C2520C-4R7G-A	T	24.4/7.4
L104	6200010800	S.COI C2520C-4R7G-A	T	27.9/10
L105	6200002041	S.COI NLV25T-101J	T	28.1/12.8
L106	6200002041	S.COI NLV25T-101J	B	17.5/16.3
L107	6200002041	S.COI NLV25T-101J	B	31.6/21.6
L108	6200002041	S.COI NLV25T-101J	T	25.2/20.8
L109	6200001831	S.COI NLV32T-100J	T	28.5/15.6
L110	6200003121	S.COI NLV32T-8R2J	T	21.1/15.1
L112	6200002041	S.COI NLV25T-101J	B	43.5/23
L113	6200002041	S.COI NLV25T-101J	T	7.2/17.6
L114	6200002041	S.COI NLV25T-101J	T	7.2/15
L116	6200003131	S.COI NLV32T-120J	T	28.5/18.6
L117	6200001831	S.COI NLV32T-100J	T	21.1/18.1
L204	6200002041	S.COI NLV25T-101J	T	18.7/32.9
L205	6200010740	S.COI C2520C-R27G-A	T	20.2/38.1
L207	6200010680	S.COI C2520C-R22G-A (0.22U)	T	21.8/41.3
L213	6200005011	S.COI NLV25T-100J	T	22.7/34.9
L215	6200010330	S.COI C2012C-R18G-A	B	27.7/38.6
L217	6200009990	S.COI C2012C-R22G-A	T	22.7/32.5
L218	6200005011	S.COI NLV25T-100J	B	25.6/43.3
L219	6200011050	S.COI C2012C-R12G-A	B	29/41.4
L220	6200010320	S.COI C2012C-R15G-A	B	34.1/37.9

M.=Mounted side (T: Mounted on the Top side, B: Mounted on the Bottom side) S.=Surface mount

[MAIN UNIT]

REF NO.	PARTS NO.	DESCRIPTION	M.	H/V LOCATION
L221	6200002041	S.COI NLV25T-101J	T	15.1/52.6
L222	6200002041	S.COI NLV25T-101J	T	45.6/61.4
L223	6200002041	S.COI NLV25T-101J	B	40.4/55.3
L224	6200002041	S.COI NLV25T-101J	B	27.5/55.7
L225	6200002041	S.COI NLV25T-101J	B	27.4/52
L226	6200002861	S.COI NLV25T-4R7J	T	40.3/57.6
L227	6200003711	S.COI NLV25T-2R7J	T	29.1/55.5
L228	6200002861	S.COI NLV25T-4R7J	T	44.6/54.7
L229	6200004671	S.COI NLV25T-3R9J	T	35.1/51.5
L230	6200002041	S.COI NLV25T-101J	B	40.4/52.2
L231	6200002041	S.COI NLV25T-101J	B	40.4/49.4
L232	6200002041	S.COI NLV25T-101J	B	27.1/49.1
L233	6200002041	S.COI NLV25T-101J	B	26.4/46.2
L234	6200010780	S.COI C2520C-1R0G-A	T	35.5/48.5
L235	6200010530	S.COI C2520C-R56G-A (0.56U)	B	32.9/49.5
L236	6200010950	S.COI C2520C-1R5G-A (1.5U)	T	43.4/50.4
L237	6200010450	S.COI C2520C-R82G-A (0.82U)	B	32.9/46.3
L238	6200002041	S.COI NLV25T-101J	B	43.9/45
L239	6200002041	S.COI NLV25T-101J	B	38.8/39.5
L240	6200002041	S.COI NLV25T-101J	T	29.5/42.1
L241	6200010870	S.COI C2520C-R33G-A (0.33U)	B	35.1/41.6
L242	6200005011	S.COI NLV25T-100J	T	33.5/29.9
L243	6140004601	S.COI LR-518A	T	28.4/35.2
L244	6200010960	S.COI C2520C-R47G-A (0.47U)	B	39.7/44.1
L245	6200005011	S.COI NLV25T-100J	B	41.2/28.3
L246	6200009990	S.COI C2012C-R22G-A	B	30.7/36.4
L247	6200010320	S.COI C2012C-R15G-A	B	42.1/38.7
L248	6200005011	S.COI NLV25T-100J	B	43.8/36.3
L301	6200002041	S.COI NLV25T-101J	T	36.1/27.4
L302	6200002041	S.COI NLV25T-101J	T	52.6/31.8
L303	6200002041	S.COI NLV25T-101J	T	52.3/35.4
L304	6140004591	S.COI LR-517A	T	56.4/39
L305	6200002041	S.COI NLV25T-101J	T	52.8/29.3
L306	6200002041	S.COI NLV25T-101J	T	61.7/39.3
L307	6200002041	S.COI NLV25T-101J	T	60.9/32
L308	6200002041	S.COI NLV25T-101J	T	64.9/33.1
L309	6200009070	S.COI LQW18AN18NG00D (LQW1608A18NG00)	T	49.3/24
L310	6200010650	S.COI C2520C-R12G-A (0.12U)	T	65.7/38.2
L311	6200009220	S.COI LQW18AN15NG00D (LQW1608A15NG00)	T	53.5/23.2
L312	6200010660	S.COI C2520C-R15G-A (0.15U)	T	69.6/34.3
L313	6200011730	S.COI LQW18AN10NG00D	T	61.5/25.7
L314	6200002041	S.COI NLV25T-101J	T	72.5/37.3
L315	6200002041	S.COI NLV25T-101J	T	75.8/31.9
L402	6140004610	S.COI LR-520	T	70.8/27.9
L403	6200002041	S.COI NLV25T-101J	T	81.1/19.7
L404	6130002961	S.COI #617DB-1327=P3	T	84.4/27.9
L406	6130002961	S.COI #617DB-1327=P3	T	77.6/24.2
L421	6200004590	S.COI MLF1608D R18K-T	T	86.4/21.7
L501	6200004660	S.COI MLF1608A 1R8K-T	T	93.4/35.7
L503	6200004660	S.COI MLF1608A 1R8K-T	T	83.2/31.1
L507	6200001981	S.COI NLV25T-1R0J	T	78.7/34.4
L508	6200010650	S.COI C2520C-R12G-A (0.12U)	T	86.3/34.4
L509	6200004660	S.COI MLF1608A 1R8K-T	T	93.1/38.7
L511	6200004150	S.COI MLF1608D 47NM-T	T	92.7/37.2
L512	6200009610	S.COI MLG1608B 39NJ-T	B	89.6/32.8
L601	6200004660	S.COI MLF1608A 1R8K-T	B	85.7/38.6
L603	6200004660	S.COI MLF1608A 1R8K-T	T	89.3/42.2
L604	6150005330	S.COI LS-548 PKI-4185	T	90.5/46.2
L605	6200004660	S.COI MLF1608A 1R8K-T	T	93.1/39.9
L607	6200011800	S.COI C2520C-47NG-A	B	85.6/43.5
L609	6200011800	S.COI C2520C-47NG-A	B	81.5/46
L610	6200004660	S.COI MLF1608A 1R8K-T	B	78.1/44.8
L611	6200004660	S.COI MLF1608A 1R8K-T	T	68/46.3
L612	6150005330	S.COI LS-548 PKI-4185	T	72.2/42.4
L701	6150005350	S.COI LS-550 PKI-4187	T	62.9/48.6
L702	6150005340	S.COI LS-549 PKI-4186	T	54.8/45.4
L703	6150005350	S.COI LS-550 PKI-4187	T	55.3/59.5
L704	6200004940	S.COI MLF1608D R27K-T	T	62.3/59.6
L705	6200009920	S.COI C2012C-R10G-A	T	61.8/41.7
L801	6140002810	S.COI LR-317	T	68.6/61.3
L802	6200005190	S.COI MLF1608D R56K-T	T	89/58.4
L803	6140002810	S.COI LR-317	T	79.6/60.1
L804	6200005011	S.COI NLV25T-100J	T	57.5/69.1
L805	6200009871	S.COI MLF1608D 120J	T	57.6/71.9
L806	6200004741	S.COI NLV25T-1R2J	T	63.1/71.2
L807	6200004741	S.COI NLV25T-1R2J	T	63.2/66.7
L808	6200004100	S.COI MLF1608D 68NM-T	T	86.1/61.6
L901	6200003520	S.COI ELJFB 102K-F	B	37.6/72.4
L904	6150005360	S.COI LS-551 PKI-4188-1	T	51.6/70.9
L905	6200003520	S.COI ELJFB 102K-F	B	40.2/59.9
L906	6200003520	S.COI ELJFB 102K-F	B	33.6/62.4
L908	6200003520	S.COI ELJFB 102K-F	B	31.5/69.7
L1003	6200003520	S.COI ELJFB 102K-F	B	12.9/75.3
L1102	6200002041	S.COI NLV25T-101J	T	7.1/89.7
L1301	6200002041	S.COI NLV25T-101J	T	8.3/55.8
L1302	6200002041	S.COI NLV25T-101J	T	11.8/58.5
L1303	6200002041	S.COI NLV25T-101J	T	4.8/55.8
L1401	6200002041	S.COI NLV25T-101J	B	43.3/79.6
L1402	6200004790	S.COI MLF1608D R47K-T	B	44.1/70.4
L1403	6200002041	S.COI NLV25T-101J	B	43/77.1
L1404	6200003711	S.COI NLV25T-2R7J	B	18.2/80.4
L1405	6200002041	S.COI NLV25T-101J	B	17.7/85
L1491	6200010870	S.COI C2520C-R33G-A (0.33U) [EUR]	B	84.9/30.7
	6200010870	S.COI C2520C-R33G-A (0.33U) [FRA]		
	6200010870	S.COI C2520C-R33G-A (0.33U) [ESP]		
	6200010740	S.COI C2520C-R27G-A [USA]		
	6200010870	S.COI C2520C-R33G-A (0.33U) [EXP]		

[MAIN UNIT]

REF NO.	PARTS NO.	DESCRIPTION	M.	H/V LOCATION
L1491	6200010870	S.COI C2520C-R33G-A (0.33U) [ITR]	B	84.9/30.7
	6200010870	S.COI C2520C-R33G-A (0.33U) [UK]		
	6200010740	S.COI C2520C-R27G-A [KOR]		
	6200010870	S.COI C2520C-R33G-A (0.33U) [AUS]		
	6200010870	S.COI C2520C-R33G-A (0.33U) [CHN]		
L1492	6200010870	S.COI C2520C-R33G-A (0.33U) [EUR]	B	80.6/33.1
	6200010870	S.COI C2520C-R33G-A (0.33U) [FRA]		
	6200010870	S.COI C2520C-R33G-A (0.33U) [ESP]		
	6200010740	S.COI C2520C-R27G-A [USA]		
	6200010870	S.COI C2520C-R33G-A (0.33U) [EXP]		
	6200010870	S.COI C2520C-R33G-A (0.33U) [ITR]		
	6200010870	S.COI C2520C-R33G-A (0.33U) [UK]		
	6200010740	S.COI C2520C-R27G-A [KOR]		
	6200010870	S.COI C2520C-R33G-A (0.33U) [AUS]		
	6200010870	S.COI C2520C-R33G-A (0.33U) [CHN]		
L1501	6200005011	S.COI NLV25T-100J	B	91.1/27.1
L1502	6200012170	S.COI MLG1608SR18J-T	B	79.4/38.2
L1503	6200012170	S.COI MLG1608SR18J-T	B	82/37.5
L1504	6200005011	S.COI NLV25T-100J	B	75.6/43.4
L1505	6200005190	S.COI MLF1608D R56K-T	B	73.2/48.5
L1506	6150005080	S.COI LS-535 (4KMH) [EUR]	T	68.7/55.4
	6150005080	S.COI LS-535 (4KMH) [FRA]		
	6150005080	S.COI LS-535 (4KMH) [ESP]		
	6150005070	S.COI LS-534 (4KMH) [USA]		
	6150005080	S.COI LS-535 (4KMH) [EXP]		
	6150005080	S.COI LS-535 (4KMH) [ITR]		
	6150005080	S.COI LS-535 (4KMH) [UK]		
	6150005070	S.COI LS-534 (4KMH) [KOR]		
	6150005080	S.COI LS-535 (4KMH) [AUS]		
	6150005080	S.COI LS-535 (4KMH) [CHN]		
L1507	6200005031	S.COI NLV25T-180J	B	71.7/62.2
L1508	6200005021	S.COI NLV25T-150J	B	77.3/79.5
L1951	6180003610	S.COI 7E10L-101M 100U 0	B	34.6/10.9
L1952	6180003610	S.COI 7E10L-101M 100U 0	B	54.7/113.3
L1953	6180003610	S.COI 7E10L-101M 100U 0	B	14/111.9
L1954	6180003610	S.COI 7E10L-101M 100U 0	B	24.4/19.8
L2001	6200005011	S.COI NLV25T-100J	B	72.5/16.4
L2002	6200002041	S.COI NLV25T-101J	B	84.5/3.8
L2003	6200002041	S.COI NLV25T-101J	B	81.1/34.3
L2004	6200002041	S.COI NLV25T-101J	B	76.3/20.4
L2006	6200002041	S.COI NLV25T-101J	B	64.2/12.8
L2007	6200002041	S.COI NLV25T-101J	B	70.9/3.8
L2008	6200002041	S.COI NLV25T-101J	B	67.9/6.1
L2009	6200005011	S.COI NLV25T-100J	B	70.8/10.6
L2010	6200002041	S.COI NLV25T-101J	B	60.7/13.7
L2011	6200011300	S.COI EXCML16A270U	T	86.6/9.1
L2012	6200011300	S.COI EXCML16A270U	B	84.7/21.9
L2013	6200002041	S.COI NLV25T-101J	B	71.8/19.4
L2015	6200002041	S.COI NLV25T-101J	B	52.5/10.4
L2016	6200002041	S.COI NLV25T-101J	B	59.2/11.2
L2017	6200002041	S.COI NLV25T-101J	B	57/14
L2018	6200002041	S.COI NLV25T-101J	B	19.7/129.4
L2019	6200002041	S.COI NLV25T-101J	B	22.2/126.9
L2020	6200002041	S.COI NLV25T-101J	B	27.9/131.3
L2021	6200005011	S.COI NLV25T-100J	B	27.9/126.6
L2022	6200002041	S.COI NLV25T-101J	B	22.6/127.6
L2023	6200002041	S.COI NLV25T-101J	B	23.2/131.3
L2024	6200002041	S.COI NLV25T-101J	T	12.7/128.2
L2025	6200002041	S.COI NLV25T-101J	B	87.5/6.2
L2026	6200002041	S.COI NLV25T-101J	B	77.6/5
L2027	6200002041	S.COI NLV25T-101J	B	76.5/12.2
L2028	6200002041	S.COI NLV25T-101J	B	67.4/10.3
L2029	6200002041	S.COI NLV25T-101J	B	64/10.3
L2030	6200002041	S.COI NLV25T-101J	B	67.5/3.6
L2031	6200002041	S.COI NLV25T-101J	B	76.5/14.7
L2032	6200002041	S.COI NLV25T-101J	B	66.1/15.3
L2033	6200011300	S.COI EXCML16A270U	B	69.6/14.5
L2034	6200009300	S.COI ELJPA 100KF 10U	B	67.8/19.3
L2035	6200002041	S.COI NLV25T-101J	B	59.8/18.4
L2036	6200002041	S.COI NLV25T-101J	B	64.1/3.8
L2037	6200002041	S.COI NLV25T-101J	B	88.3/3.7
L2041	6180003610	S.COI 7E10L-101M 100U 0	B	62.6/86.9
L2042	6200002861	S.COI NLV25T-4R7J	B	62.9/79.3
L2053	6200002041	S.COI NLV25T-101J	B	28.7/90.9
L2151	6200002041	S.COI NLV25T-101J	B	36.9/121
L2152	6200002041	S.COI NLV25T-101J	B	52.3/14.7
L2201	6200005011	S.COI NLV25T-100J	T	27.3/125.8
L2202	6200005011	S.COI NLV25T-100J	T	17/124.3
L2231	6200002041	S.COI NLV25T-101J	T	34/104.2
L2256	6200002041	S.COI NLV25T-101J	T	15/103.4
L2257	6200002041	S.COI NLV25T-101J	T	10.5/89.7
L2260	6200002041	S.COI NLV25T-101J	T	68.5/110.9
L2263	6200002041	S.COI NLV25T-101J	T	62.3/99.4
L2264	6200002041	S.COI NLV25T-101J	T	62.3/96.9
L2265	6200002041	S.COI NLV25T-101J	T	62.4/94.3
L2266	6200002041	S.COI NLV25T-101J	T	62.4/91.5
L2267	6200002041	S.COI NLV25T-101J	T	66/89.6
L2268	6200002041	S.COI NLV25T-101J	T	62.4/87.1
L2272	6200002041	S.COI NLV25T-101J	T	71.1/90.2
L2402	6200002041	S.COI NLV25T-101J	B	89.4/98
L2403	6200002041	S.COI NLV25T-101J	B	89.2/84
L2404	620			

[MAIN UNIT]

REF NO.	PARTS NO.	DESCRIPTION	M.	H/V LOCATION
R1	7030011400	S.RES ERJ2GEJ 5R6 X (5.6)	T	79.7/17
R2	7030009270	S.RES ERJ2GEJ 821 X (820)	T	81.3/17
R3	7030009270	S.RES ERJ2GEJ 821 X (820)	T	79.7/17.9
R5	7030010090	S.RES ERJ2GEJ 180 X (18)	T	74.2/16.7
R6	7030008280	S.RES ERJ2GEJ 271 X (270)	T	74.8/15.8
R7	7030008280	S.RES ERJ2GEJ 271 X (270)	T	73.2/15.8
R8	7030009200	S.RES ERJ2GEJ 390 X (39)	T	73/18.5
R9	7030003400	S.RES ERJ3GEJ 471 V (470)	T	69.9/13.3
R10	7030005120	S.RES ERJ2GEJ 102 X (1K)	T	72.8/14.9
R11	7030005300	S.RES ERJ2GEJ 150 X (15)	T	62.1/15.9
R12	7030010040	S.RES ERJ2GEJ-JPW	T	62.9/13.8
R13	7030005090	S.RES ERJ2GEJ 104 X (100K)	T	66.8/20.6
R15	7030005090	S.RES ERJ2GEJ 104 X (100K)	T	70.4/10.4
R16	7030003860	S.RES ERJ3GE JPW V	T	62.4/12.3
R17	7030005090	S.RES ERJ2GEJ 104 X (100K)	T	76.4/15.8
R18	7030007270	S.RES ERJ2GEJ 151 X (150)	T	44.2/17.2
R19	7030003860	S.RES ERJ3GE JPW V	T	50.4/14.6
R20	7030009530	S.RES ERJ2GEJ 270 X (27)	T	69.5/19.7
R21	7030009530	S.RES ERJ2GEJ 270 X (27)	T	65.4/22.8
R22	7030010040	S.RES ERJ2GEJ-JPW	T	78.1/13.8
R23	7030007290	S.RES ERJ2GEJ 222 X (2.2K)	T	79.8/13.8
R24	7030005010	S.RES ERJ2GEJ 681 X (680)	T	78.1/12.9
R25	7030005120	S.RES ERJ2GEJ 102 X (1K)	B	79.2/18.5
R27	7030005120	S.RES ERJ2GEJ 102 X (1K)	B	81.3/8.5
R29	7030004980	S.RES ERJ2GEJ 101 X (100)	T	73.1/11.3
R30	7030009160	S.RES ERJ2GEJ 181 X (180)	T	46.4/15.4
R31	7030007270	S.RES ERJ2GEJ 151 X (150)	T	42.6/17.1
R32	7030009200	S.RES ERJ2GEJ 390 X (39)	T	44.1/18.2
R35	7030003860	S.RES ERJ3GE JPW V	T	59.9/17.8
	7030003860	S.RES ERJ3GE JPW V	[EUR]	
	7030003860	S.RES ERJ3GE JPW V	[FRA]	
	7030003860	S.RES ERJ3GE JPW V	[ESP]	
	7030003860	S.RES ERJ3GE JPW V	[USA]	
	7030003860	S.RES ERJ3GE JPW V	[EXP]	
	7030003860	S.RES ERJ3GE JPW V	[ITR]	
	7030003860	S.RES ERJ3GE JPW V	[UK]	
	7030003860	S.RES ERJ3GE JPW V	[KOR]	
	7030003860	S.RES ERJ3GE JPW V	[CHN]	
R101	7030005050	S.RES ERJ2GEJ 103 X (10K)	T	13.2/16
R102	7030005120	S.RES ERJ2GEJ 102 X (1K)	T	11.9/14.6
R103	7030005050	S.RES ERJ2GEJ 103 X (10K)	T	10.3/14.6
R104	7030005090	S.RES ERJ2GEJ 104 X (100K)	T	15.7/13.4
R105	7030005580	S.RES ERJ2GEJ 560 X (56)	T	15.7/22.2
R106	7030005000	S.RES ERJ2GEJ 471 X (470)	T	13.2/20.5
R107	7030005000	S.RES ERJ2GEJ 471 X (470)	T	10.8/22.1
R108	7030005000	S.RES ERJ2GEJ 471 X (470)	T	10.8/21.2
R111	7030005000	S.RES ERJ2GEJ 471 X (470)	T	10.8/21.2
R112	7030005090	S.RES ERJ2GEJ 104 X (100K)	T	25.6/12.5
R113	7030005090	S.RES ERJ2GEJ 104 X (100K)	T	26.8/10.4
R114	7030009280	S.RES ERJ2GEJ 391 X	B	33.1/23.4
R115	7030009280	S.RES ERJ2GEJ 391 X	B	34.1/22.2
R116	7030009280	S.RES ERJ2GEJ 391 X	T	22.3/21.3
R117	7030009280	S.RES ERJ2GEJ 391 X	T	20.7/21.3
R118	7030009280	S.RES ERJ2GEJ 391 X	B	40.9/23.2
R119	7030009280	S.RES ERJ2GEJ 391 X	B	40.9/23.2
R120	7030005090	S.RES ERJ2GEJ 104 X (100K)	B	50.3/23.5
R121	7030005090	S.RES ERJ2GEJ 104 X (100K)	T	44/22.2
R122	7030009280	S.RES ERJ2GEJ 391 X	T	7.8/20.3
R123	7030009280	S.RES ERJ2GEJ 391 X	T	7.8/19.4
R125	7030009280	S.RES ERJ2GEJ 391 X	T	35.5/20.2
R126	7030009280	S.RES ERJ2GEJ 391 X	T	27.4/8
R127	7030009280	S.RES ERJ2GEJ 391 X	T	25.4/4.8
R128	7030009280	S.RES ERJ2GEJ 391 X	T	35.5/19.3
R202	7030005090	S.RES ERJ2GEJ 104 X (100K)	T	18.1/31.2
R203	7030005090	S.RES ERJ2GEJ 104 X (100K)	T	42.9/59.9
R204	7030005090	S.RES ERJ2GEJ 104 X (100K)	B	42.9/54.3
R205	7030009280	S.RES ERJ2GEJ 391 X	T	19.4/54.2
R206	7030005090	S.RES ERJ2GEJ 104 X (100K)	B	42.9/51.4
R207	7030005090	S.RES ERJ2GEJ 104 X (100K)	B	42.9/50.5
R208	7030005090	S.RES ERJ2GEJ 104 X (100K)	B	46.4/45
R216	7030005090	S.RES ERJ2GEJ 104 X (100K)	B	44.2/43.3
R217	7030005050	S.RES ERJ2GEJ 103 X (10K)	T	18.1/30.3
R218	7030004970	S.RES ERJ2GEJ 470 X (47)	T	21.9/29.9
R225	7030005050	S.RES ERJ2GEJ 103 X (10K)	T	19.1/29.1
R226	7030009280	S.RES ERJ2GEJ 391 X	T	17.6/54.2
R227	7030005120	S.RES ERJ2GEJ 102 X (1K)	T	30.9/30.9
R228	7030009140	S.RES ERJ2GEJ 272 X (2.7K)	T	30.9/29.1
R301	7030009280	S.RES ERJ2GEJ 391 X	T	44.5/28.8
R302	7030009280	S.RES ERJ2GEJ 391 X	T	38.6/27.8
R303	7030004970	S.RES ERJ2GEJ 470 X (47)	T	52.5/38.9
R304	7030004980	S.RES ERJ2GEJ 101 X (100)	T	55.1/35.6
R305	7030005120	S.RES ERJ2GEJ 102 X (1K)	T	59.9/33.8
R306	7030008280	S.RES ERJ2GEJ 271 X (270)	T	55.3/28.7
R307	7030004980	S.RES ERJ2GEJ 101 X (100)	T	56.7/35.6
R308	7030007290	S.RES ERJ2GEJ 222 X (2.2K)	T	59.2/30.1
R309	7030008280	S.RES ERJ2GEJ 271 X (270)	T	58.5/29.1
R310	7030005090	S.RES ERJ2GEJ 104 X (100K)	T	50.1/31.7
R311	7030009280	S.RES ERJ2GEJ 391 X	T	65.3/31.3
R312	7030009280	S.RES ERJ2GEJ 391 X	T	63.7/31.3
R314	7030009280	S.RES ERJ2GEJ 391 X	T	73.3/32.5
R315	7030009280	S.RES ERJ2GEJ 391 X	T	74.8/33.8
R401	7030010040	S.RES ERJ2GEJ-JPW	T	75/29.5
R402	7030010040	S.RES ERJ2GEJ-JPW	T	75/27.7
R403	7030004980	S.RES ERJ2GEJ 101 X (100)	T	76.7/29.6
R404	7030010040	S.RES ERJ2GEJ-JPW	T	71.9/23.1
R405	7030004980	S.RES ERJ2GEJ 101 X (100)	T	86.8/23.8
R406	7030005580	S.RES ERJ2GEJ 560 X (56)	T	71.1/30.6
R407	7030005580	S.RES ERJ2GEJ 560 X (56)	T	71.9/24.9
R408	7030010040	S.RES ERJ2GEJ-JPW	T	83.3/19.2
R411	7030007260	S.RES ERJ2GEJ 330 X (33)	T	80/29.5

[MAIN UNIT]

REF NO.	PARTS NO.	DESCRIPTION	M.	H/V LOCATION
R412	7030007260	S.RES ERJ2GEJ 330 X (33)	T	80/26.8
R414	7030004980	S.RES ERJ2GEJ 101 X (100)	T	78.3/29.6
R416	7030010090	S.RES ERJ2GEJ 180 X (18)	T	88.3/24.4
R417	7030008280	S.RES ERJ2GEJ 271 X (270)	T	89.2/25.3
R418	7030008280	S.RES ERJ2GEJ 271 X (270)	T	88/22.8
R421	7030010090	S.RES ERJ2GEJ 180 X (18)	B	88.5/20.9
R422	7030008280	S.RES ERJ2GEJ 271 X (270)	B	90.1/20.2
R423	7030008280	S.RES ERJ2GEJ 271 X (270)	B	90.1/19.3
R424	7030005530	S.RES ERJ2GEJ 100 X (10)	T	88.5/21.6
R501	7030005120	S.RES ERJ2GEJ 102 X (1K)	T	91.3/35.6
R502	7030005120	S.RES ERJ2GEJ 102 X (1K)	T	92.9/34.4
R509	7030005580	S.RES ERJ2GEJ 560 X (56)	T	83.4/33.1
R510	7030010040	S.RES ERJ2GEJ-JPW	T	83.4/34.1
R512	7030004980	S.RES ERJ2GEJ 101 X (100)	T	81.7/34.1
R517	7030010040	S.RES ERJ2GEJ-JPW	B	80/31
R518	7030007290	S.RES ERJ2GEJ 222 X (2.2K)	T	79.5/37
R519	7030007290	S.RES ERJ2GEJ 222 X (2.2K)	T	79.5/38.8
R520	7030005120	S.RES ERJ2GEJ 102 X (1K)	T	89.1/39.2
R521	7030005000	S.RES ERJ2GEJ 471 X (470)	T	84.2/40.4
R523	7030005120	S.RES ERJ2GEJ 102 X (1K)	T	91.3/34.7
R524	7030005120	S.RES ERJ2GEJ 102 X (1K)	B	86.9/37
R601	7030005000	S.RES ERJ2GEJ 471 X (470)	B	88.5/40
R602	7030005000	S.RES ERJ2GEJ 471 X (470)	T	91/39.6
R603	7030005000	S.RES ERJ2GEJ 471 X (470)	T	89.1/41
R604	7030005000	S.RES ERJ2GEJ 471 X (470)	B	78.6/45.9
R605	7030010040	S.RES ERJ2GEJ-JPW	T	68.2/45.2
R606	7030005090	S.RES ERJ2GEJ 104 X (100K)	T	67.1/47.4
R607	7030005120	S.RES ERJ2GEJ 102 X (1K)	T	66.6/45.2
R701	7030005220	S.RES ERJ2GEJ 223 X (22K)	T	61.1/53
R702	7030005120	S.RES ERJ2GEJ 102 X (1K)	T	64.2/43.9
R703	7030004970	S.RES ERJ2GEJ 470 X (47)	T	50.8/44.1
R705	7030004990	S.RES ERJ2GEJ 221 X (220)	T	59/51.5
R706	7030009270	S.RES ERJ2GEJ 821 X (820)	T	64.5/55.9
R707	7030004980	S.RES ERJ2GEJ 101 X (100)	T	59.5/57
R708	7030007290	S.RES ERJ2GEJ 222 X (2.2K)	T	63.9/58.6
R709	7030005210	S.RES ERJ2GEJ 822 X (8.2K)	T	59.5/55.1
R710	7030005120	S.RES ERJ2GEJ 102 X (1K)	T	59.8/62.5
R711	7030009140	S.RES ERJ2GEJ 272 X (2.7K)	T	50.5/51.4
R712	7030005120	S.RES ERJ2GEJ 102 X (1K)	T	51.2/50.5
R713	7030005050	S.RES ERJ2GEJ 103 X (10K)	T	57.1/51.5
R715	7030004970	S.RES ERJ2GEJ 470 X (47)	T	52.1/54.1
R716	7030005710	S.RES ERJ2GEJ 121 X (120)	T	51.3/57.5
R717	7030007300	S.RES ERJ2GEJ 332 X (3.3K)	T	52.1/51.4
R718	7510001461	S.THE NTCG16 3NH 471JT	T	63.3/54
R801	7030008280	S.RES ERJ2GEJ 271 X (270)	T	86.8/55.2
R802	7030005120	S.RES ERJ2GEJ 102 X (1K)	T	65.3/60.9
R803	7030005120	S.RES ERJ2GEJ 102 X (1K)	T	71.9/64.9
R804	7030005530	S.RES ERJ2GEJ 100 X (10)	T	91.1/57.1
R805	7030010090	S.RES ERJ2GEJ 180 X (18)	T	84.7/54.3
R806	7030008280	S.RES ERJ2GEJ 271 X (270)	T	85.2/55.2
R807	7030005120	S.RES ERJ2GEJ 102 X (1K)	T	62.8/64.6
R808	7030004970	S.RES ERJ2GEJ 470 X (47)	T	62.3/69.4
R809	7030008280	S.RES ERJ2GEJ 271 X (270)	T	82.8/60.6
R810	7030010090	S.RES ERJ2GEJ 180 X (18)	T	84.4/60.6
R811	7030008280	S.RES ERJ2GEJ 271 X (270)	T	82.8/59.7
R904	7030003860	S.RES ERJ3GE JPW V	T	36.5/68.1
R905	7030004980	S.RES ERJ2GEJ 101 X (100)	T	39.2/64.6
R906	7030007290	S.RES ERJ2GEJ 222 X (2.2K)	T	39.2/66.5
R908	7030005000	S.RES ERJ2GEJ 471 X (470)	T	35.6/61.9
R909	7030008410	S.RES ERJ2GEJ 392 X (3.9K)	T	34.2/68.4
R912	7030005210	S.RES ERJ2GEJ 822 X (8.2K)	T	34.2/66.6
R913	7030007300	S.RES ERJ2GEJ 332 X (3.3K)	T	40.5/75
R914	7030009290	S.RES ERJ2GEJ 562 X (5.6K)	T	35.6/75.4
R915	7030007290	S.RES ERJ2GEJ 222 X (2.2K)	T	36.6/70.9
R916	7030005050	S.RES ERJ2GEJ 103 X (10K)	T	37.2/75.4
R917	7030004970	S.RES ERJ2GEJ 470 X (47)	T	34.2/69.3
R918	7030007290	S.RES ERJ2GEJ 222 X (2.2K)	B	31.4/72.1
R919	7030004980	S.RES ERJ2GEJ 101 X (100)	T	31.5/72.1
R1009	7030009290	S.RES ERJ2GEJ 562 X (5.6K)	T	25.8/72.9
R1018	7030007290	S.RES ERJ2GEJ 222 X (2.2K)	T	20.3/75
R1019	7030005050	S.RES ERJ2GEJ 103 X (10K)	T	20.3/76.9
R1020	7030005000	S.RES ERJ2GEJ 471 X (470)	T	12.7/77.6
R1022	7510001461	S.THE NTCG16 3NH 471JT	T	14.8/76.8
R1023	7030008370	S.RES ERJ2GEJ 561 X (560)	T	15.2/77.8
R1024	7030004980	S.RES ERJ2GEJ 101 X (100)	T	12.7/74.9
R1025	7030007260	S.RES ERJ2GEJ 330 X (33)	T	12.7/76.7
R1027	7030005120	S.RES ERJ2GEJ 102 X (1K)	T	4.6/87.8
R1201	7030005000	S.RES ERJ2GEJ 471 X (470)	T	25.7/77.6
R1202	7030005240	S.RES ERJ2GEJ 473 X (47K)	T	24.7/8.5
R1203	7030005240	S.RES ERJ2GEJ 473 X (47K)	T	25.6/78.5
R1204	7030005240	S.RES ERJ2GEJ 473 X (47K)	T	20.2/79.2
R1205	7030005000	S.RES ERJ2GEJ 471 X (470)	T	20.2/78.3
R1206	7030005090	S.RES ERJ2GEJ 104 X (100K)	T	21.8/79.2
R1207	7030005240	S.RES ERJ2GEJ 473 X (47K)	T	17.9/83.6
R1208	7030004980	S.RES ERJ2GEJ 101 X (100)	T	9.4/79.8
R1209	7030004980	S.RES ERJ2GEJ 101 X (100)	T	16.4/79.9
R1211	7030005120	S.RES ERJ2GEJ 102 X (1K)		

[MAIN UNIT]

REF NO.	PARTS NO.	DESCRIPTION	M.	H/V LOCATION
R1306	7030005120	S.RES ERJ2GEJ 102 X (1K)	T	10.9/56.8
R1308	7030007300	S.RES ERJ2GEJ 332 X (3.3K)	T	12.9/67.3
R1309	7030005120	S.RES ERJ2GEJ 102 X (1K)	T	11.3/66.4
R1310	7510001451	S.THE NTCG16 4BH 472JT	T	12.2/68.4
R1401	7030005120	S.RES ERJ2GEJ 102 X (1K)	B	45.3/72.3
R1402	7030008010	S.RES ERJ2GEJ 123 X (12K)	B	43.6/72.3
R1403	7030007290	S.RES ERJ2GEJ 222 X (2.2K)	B	44.5/73.4
R1404	7030007280	S.RES ERJ2GEJ 331 X (330)	B	44.5/75.2
R1405	7030004970	S.RES ERJ2GEJ 470 X (47)	B	42/71.5
R1406	7030005290	S.RES ERJ2GEJ 682 X (6.8K)	B	38.7/79.9
R1407	7030005120	S.RES ERJ2GEJ 102 X (1K)	B	38.7/77.9
R1408	7030007280	S.RES ERJ2GEJ 331 X (330)	B	38.7/80.8
R1409	7030004970	S.RES ERJ2GEJ 470 X (47)	B	34.6/80
R1414	7030007340	S.RES ERJ2GEJ 153 X (15K)	B	20.2/76.4
R1416	7030008410	S.RES ERJ2GEJ 392 X (3.9K)	B	19.4/83
R1420	7030004990	S.RES ERJ2GEJ 221 X (220)	B	25/76.8
R1421	7030007270	S.RES ERJ2GEJ 151 X (150)	B	23.2/75.9
R1422	7030004990	S.RES ERJ2GEJ 221 X (220)	B	23.2/76.8
R1501	7030010040	S.RES ERJ2GEJ-JPW	B	72.4/38.2
R1502	7030005100	S.RES ERJ2GEJ 154 X (150K)	B	86.4/55.3
R1503	7030005100	S.RES ERJ2GEJ 154 X (150K)	B	85.7/54.1
R1504	7030004970	S.RES ERJ2GEJ 470 X (47)	B	72.4/40.3
R1505	7030007290	S.RES ERJ2GEJ 222 X (2.2K)	B	71.8/53.9
R1506	7030007350	S.RES ERJ2GEJ 393 X (39K)	B	85.7/52.3
R1507	7030007350	S.RES ERJ2GEJ 393 X (39K)	B	85.7/53.2
R1508	7030005220	S.RES ERJ2GEJ 223 X (22K)	B	74.2/61.6
R1509	7030006610	S.RES ERJ2GEJ 394 X (390K)	B	85.9/59
R1510	7030005050	S.RES ERJ2GEJ 103 X (10K) [USA] only	B	76.6/61.9
R1511	7030005590	S.RES ERJ2GEJ 680 X (68)	B	85.8/60.8
R1512	7030005120	S.RES ERJ2GEJ 102 X (1K)	B	71.5/73.7
R1513	7030007280	S.RES ERJ2GEJ 331 X (330)	B	73.1/73.7
R1514	7030007290	S.RES ERJ2GEJ 222 X (2.2K)	B	73.4/53
R1515	7030007290	S.RES ERJ2GEJ 222 X (2.2K)	B	71.8/53
R1516	7030004970	S.RES ERJ2GEJ 470 X (47)	B	82.5/35.3
R1521	7030005090	S.RES ERJ2GEJ 104 X (100K)	B	86.5/50.3
R1522	7030005240	S.RES ERJ2GEJ 473 X (47K)	B	86.7/46.8
R1523	7030005120	S.RES ERJ2GEJ 102 X (1K)	B	77.3/39.5
R1524	7030005120	S.RES ERJ2GEJ 102 X (1K)	B	81.9/40.3
R1525	7030007300	S.RES ERJ2GEJ 332 X (3.3K)	B	81.9/42.2
R1526	7030005120	S.RES ERJ2GEJ 102 X (1K)	B	83.5/40.5
R1602	7030005120	S.RES ERJ2GEJ 102 X (1K)	T	6.3/54
R1603	7030010040	S.RES ERJ2GEJ-JPW	T	13/49.6
R1604	7030007290	S.RES ERJ2GEJ 222 X (2.2K)	T	13/50.5
R1605	7030005090	S.RES ERJ2GEJ 104 X (100K)	T	8.8/46.9
R1606	7030005070	S.RES ERJ2GEJ 683 X (68K)	T	6.1/46.6
R1607	7030005070	S.RES ERJ2GEJ 683 X (68K)	T	5.1/42.1
R1608	7030005090	S.RES ERJ2GEJ 104 X (100K)	T	10.4/47.8
R1609	7030007320	S.RES ERJ2GEJ 225 X (2.2M)	T	10.4/46
R1610	7030005060	S.RES ERJ2GEJ 333 X (33K)	T	4.5/43.5
R1611	7030005230	S.RES ERJ2GEJ 334 X (330K)	T	8.8/47.8
R1612	7030005060	S.RES ERJ2GEJ 333 X (33K)	T	3.4/42.3
R1613	7030003860	S.RES ERJ3GE JPW V	T	6.7/48.7
R1614	7030007310	S.RES ERJ2GEJ 155 X (1.5M)	T	6.1/45.7
R1615	7030005040	S.RES ERJ2GEJ 472 X (4.7K)	T	4.2/35.4
R1616	7030005090	S.RES ERJ2GEJ 104 X (100K)	T	6.7/35.4
R1617	7030005720	S.RES ERJ2GEJ 563 X (56K)	T	3.4/38.2
R1618	7310005020	S.TRI RH03ADC14X (10K) 1	T	3.5/46.3
R1619	7030005080	S.RES ERJ2GEJ 823 X (82K) [EUR]	T	2.6/43.3
	7030005080	S.RES ERJ2GEJ 823 X (82K) [FRA]		
	7030005080	S.RES ERJ2GEJ 823 X (82K) [ESP]		
	7030005080	S.RES ERJ2GEJ 823 X (82K) [USA]		
	7030005080	S.RES ERJ2GEJ 823 X (82K) [EXP]		
	7030005080	S.RES ERJ2GEJ 823 X (82K) [ITR]		
	7030005080	S.RES ERJ2GEJ 823 X (82K) [UK]		
	7030005080	S.RES ERJ2GEJ 823 X (82K) [KOR]		
	7030005720	S.RES ERJ2GEJ 563 X (56K) [AUS]		
	7030005080	S.RES ERJ2GEJ 823 X (82K) [CHN]		
R1620	7030008290	S.RES ERJ2GEJ 183 X (18K)	T	3.4/37.3
R1621	7030005160	S.RES ERJ2GEJ 105 X (1M)	T	6.7/37.2
R1622	7030010040	S.RES ERJ2GEJ-JPW	T	5/37.3
R1623	7030005000	S.RES ERJ2GEJ 471 X (470)	T	12/46.8
R1624	7030007250	S.RES ERJ2GEJ 220 X (22)	T	14.9/38.3
R1625	7030004990	S.RES ERJ2GEJ 221 X (220)	T	13.6/32.6
R1626	7030005050	S.RES ERJ2GEJ 103 X (10K)	T	10.3/34.5
R1627	7030007320	S.RES ERJ2GEJ 225 X (2.2M)	T	10.3/35.4
R1628	7030005120	S.RES ERJ2GEJ 102 X (1K)	T	4.9/30.8
R1629	7030005050	S.RES ERJ2GEJ 103 X (10K)	T	4.9/29.9
R1630	7030004980	S.RES ERJ2GEJ 101 X (100)	T	8.3/45.7
R1631	7030005090	S.RES ERJ2GEJ 104 X (100K)	T	9.8/37.2
R1634	7030005040	S.RES ERJ2GEJ 472 X (4.7K)	T	10.3/33.6
R1636	7030007320	S.RES ERJ2GEJ 225 X (2.2M)	T	13/31.7
R1637	7030007320	S.RES ERJ2GEJ 225 X (2.2M)	T	12/45.9
R1638	7030008280	S.RES ERJ2GEJ 271 X (270)	T	10.9/48.8
R1639	7030005120	S.RES ERJ2GEJ 102 X (1K)	T	14.6/50.5
R1640	7030005090	S.RES ERJ2GEJ 104 X (100K)	T	10.9/31.6
R1641	7030007320	S.RES ERJ2GEJ 225 X (2.2M)	T	13/30.7
R1642	7030005120	S.RES ERJ2GEJ 102 X (1K)	T	22.9/55.1
R1701	7030009320	S.RES ERJ2GEJ 4R7 X (4.7)	T	48/45.3
R1702	7030007280	S.RES ERJ2GEJ 331 X (330)	B	52.1/44.7
R1703	7030007280	S.RES ERJ2GEJ 331 X (330)	B	53.7/43.8
R1704	7030007280	S.RES ERJ2GEJ 331 X (330)	B	53.7/44.7
R1705	7030009320	S.RES ERJ2GEJ 4R7 X (4.7)	T	48/46.2
R1706	7030007280	S.RES ERJ2GEJ 331 X (330)	B	53.6/64.2
R1707	7030007280	S.RES ERJ2GEJ 331 X (330)	B	55.6/64.8
R1708	7030007280	S.RES ERJ2GEJ 331 X (330)	B	55.6/65.7
R1901	7030005090	S.RES ERJ2GEJ 104 X (100K)	B	20/13.9
R1902	7030011290	S.RES ERJ12YJR8U (1.8)	B	12.4/45.8
R1952	7030009980	S.RES ERJ12RSJR15U	B	42.6/102.3
R1953	7030009980	S.RES ERJ12RSJR15U	B	42.6/98.6

[MAIN UNIT]

REF NO.	PARTS NO.	DESCRIPTION	M.	H/V LOCATION
R1954	7030005170	S.RES ERJ2GEJ 474 X (470K)	B	42.7/111.3
R1955	7030005511	S.RES ERA3YED 303V (30K)	B	44.8/107.3
R1956	7030005110	S.RES ERJ2GEJ 224 X (220K)	B	33.7/105.1
R1957	7030007350	S.RES ERJ2GEJ 393 X (39K)	B	35.3/104.2
R1958	7030005720	S.RES ERJ2GEJ 563 X (56K)	B	35.3/103.3
R1981	7030008240	S.RES ERJ12Y0R00U	B	83.1/109
R2002	7030010040	S.RES ERJ2GEJ-JPW	B	36.9/12.7
R2003	7030008240	S.RES ERJ12Y0R00U	T	55.7/7.9
R2004	7030004990	S.RES ERJ2GEJ 221 X (220)	B	59.8/9.2
R2005	7030004990	S.RES ERJ2GEJ 221 X (220)	B	59.1/3
R2006	7030004990	S.RES ERJ2GEJ 221 X (220)	B	60.7/3.7
R2007	7030004990	S.RES ERJ2GEJ 221 X (220)	B	60.7/4.6
R2008	7030010040	S.RES ERJ2GEJ-JPW	B	34/17.6
R2010	7030010040	S.RES ERJ2GEJ-JPW	B	32.5/15.1
R2011	7030006210	S.RES ERJ12YJ4R7U (4.7)	B	13.1/26.3
R2012	7030005120	S.RES ERJ2GEJ 102 X (1K)	B	32.4/17.3
R2101	7030005090	S.RES ERJ2GEJ 104 X (100K)	T	26/113.8
R2102	7030005090	S.RES ERJ2GEJ 104 X (100K)	T	33.1/114.3
R2103	7030005090	S.RES ERJ2GEJ 104 X (100K)	T	30.7/123.2
R2104	7030005090	S.RES ERJ2GEJ 104 X (100K)	T	28.1/123.2
R2105	7030005090	S.RES ERJ2GEJ 104 X (100K)	T	32.3/118.7
R2106	7030005720	S.RES ERJ2GEJ 563 X (56K)	T	25/115.5
R2107	7030005720	S.RES ERJ2GEJ 563 X (56K)	T	31.5/114.6
R2108	7030005100	S.RES ERJ2GEJ 154 X (150K)	T	30.7/122.3
R2109	7030007350	S.RES ERJ2GEJ 393 X (39K)	T	27.1/122.3
R2110	7030005090	S.RES ERJ2GEJ 104 X (100K)	T	44.3/111.8
R2111	7030005090	S.RES ERJ2GEJ 104 X (100K)	T	44.7/110
R2112	7030005090	S.RES ERJ2GEJ 104 X (100K)	T	54.1/110.8
R2113	7030005090	S.RES ERJ2GEJ 104 X (100K)	T	54.1/111.7
R2114	7030005100	S.RES ERJ2GEJ 154 X (150K)	T	44.7/112.7
R2115	7030005100	S.RES ERJ2GEJ 154 X (150K)	T	44.7/109.1
R2116	7030005100	S.RES ERJ2GEJ 154 X (150K)	T	54.4/109.9
R2117	7030005100	S.RES ERJ2GEJ 154 X (150K)	T	54.1/112.6
R2118	7030005090	S.RES ERJ2GEJ 104 X (100K)	T	54.1/120.6
R2119	7030005090	S.RES ERJ2GEJ 104 X (100K)	T	54.1/121.8
R2120	7030008300	S.RES ERJ2GEJ 184 X (180K)	T	44.8/122.1
R2121	7030008300	S.RES ERJ2GEJ 184 X (180K)	T	42.9/121.3
R2122	7030005100	S.RES ERJ2GEJ 154 X (150K)	T	54.1/119.7
R2123	7030006610	S.RES ERJ2GEJ 394 X (390K)	T	54.2/122.8
R2124	7030005110	S.RES ERJ2GEJ 224 X (220K)	T	44.8/123
R2125	7030005110	S.RES ERJ2GEJ 224 X (220K)	T	44.8/119.4
R2126	7030010040	S.RES ERJ2GEJ-JPW	T	33.1/16.4
R2128	7030005000	S.RES ERJ2GEJ 471 X (470)	T	32.3/123.2
R2129	7030005000	S.RES ERJ2GEJ 471 X (470)	T	54.1/118.8
R2131	7030005090	S.RES ERJ2GEJ 104 X (100K)	B	39.8/122
R2132	7030005090	S.RES ERJ2GEJ 104 X (100K)	T	42.8/115.1
R2133	7030005090	S.RES ERJ2GEJ 104 X (100K)	T	40.6/114.1
R2134	7030005090	S.RES ERJ2GEJ 104 X (100K)	T	36.5/114.1
R2135	7030005090	S.RES ERJ2GEJ 104 X (100K)	T	34.9/114.2
R2136	7030005000	S.RES ERJ2GEJ 471 X (470)	T	26.5/123.2
R2137	7030005230	S.RES ERJ2GEJ 334 X (330K)	T	43.3/123.7
R2138	7030005230	S.RES ERJ2GEJ 334 X (330K)	T	42.9/122.2
R2139	7030004980	S.RES ERJ2GEJ 101 X (100)	T	25/116.4
R2140	7030004980	S.RES ERJ2GEJ 101 X (100)	T	32/115.5
R2141	7030010040	S.RES ERJ2GEJ-JPW	T	44.7/113.6
R2142	7030010040	S.RES ERJ2GEJ-JPW	T	52.7/108.9
R2143	7030010040	S.RES ERJ2GEJ-JPW	T	56/109.9
R2144	7030010040	S.RES ERJ2GEJ-JPW	T	51.3/115.1
R2145	7030010040	S.RES ERJ2GEJ-JPW	T	58.1/123.6
R2146	7030010040	S.RES ERJ2GEJ-JPW	T	46.3/124
R2147	7030010040	S.RES ERJ2GEJ-JPW	T	46/118.5
R2151	7030005240	S.RES ERJ2GEJ 473 X (47K)	T	52.3/101.7
R2152	7030005120	S.RES ERJ2GEJ 102 X (1K)	T	56.5/107.1
R2153	7030005240	S.RES ERJ2GEJ 473 X (47K)	T	24.8/112.5
R2154	7030005120	S.RES ERJ2GEJ 102 X (1K)	T	25.6/111.6
R2155	7030005240	S.RES ERJ2GEJ 473 X (47K)	T	46.1/104.6
R2156	7030005120	S.RES ERJ2GEJ 102 X (1K)	T	46.1/105.5
R2157	7030005530	S.RES ERJ2GEJ 100 X (10)	B	33.3/120.8
R2158	7030005530	S.RES ERJ2GEJ 100 X (10)	B	33.3/119.8
R2159	7030005530	S.RES ERJ2GEJ 100 X (10)	B	35.1/118.3
R2160	7030005530	S.RES ERJ2GEJ 100 X (10)	B	40.7/94.3
R2161	7030005530	S.RES ERJ2GEJ 100 X (10)	B	40.7/95.2
R2162	7030005530	S.RES ERJ2GEJ 100 X (10)	B	30.2/93.8
R2163	7030005530	S.RES ERJ2GEJ 100 X (10)	B	30.9/95.9
R2164	7030005530	S.RES ERJ2GEJ 100 X (10)	B	30.2/94.7
R2165	7030005530	S.RES ERJ2GEJ 100 X (10)	B	29.3/95.9
R2166	7030005530	S.RES ERJ2GEJ 100 X (10)	T	51.8/93.3
R2167	7030005530	S.RES ERJ2GEJ 100 X (10)	T	51.8/94.2
R2168	7030005530	S.RES ERJ2GEJ 100 X (10)	T	51.8/95.1
R2169	7030005120	S.RES ERJ2GEJ 102 X (1K)	T	8.8/118.5
R2170	7030005170	S.RES ERJ2GEJ 474 X (470K)	T	5/104.5
R2171	7030005240	S.RES ERJ2GEJ 473 X (47K)	T	9.7/114.2
R				

[MAIN UNIT]

REF NO.	PARTS NO.	DESCRIPTION	M.	H/V LOCATION
R2215	7030005040	S.RES ERJ2GEJ 472 X (4.7K)	T	11.1/120.6
R2217	7030007280	S.RES ERJ2GEJ 331 X (330)	T	24.9/121.5
R2218	7030007270	S.RES ERJ2GEJ 151 X (150)	T	15.5/127.5
R2219	7030007280	S.RES ERJ2GEJ 331 X (330)	T	17.7/126.1
R2220	7030008280	S.RES ERJ2GEJ 271 X (270)	T	16.1/126.1
R2221	7030005050	S.RES ERJ2GEJ 103 X (10K)	T	9.5/120.5
R2230	7030010900	S.RES ERJ3GEVJ 750 V (75)	T	40.4/105.8
R2231	7030005050	S.RES ERJ2GEJ 103 X (10K)	T	4.5/118.2
R2232	7030005050	S.RES ERJ2GEJ 103 X (10K)	T	54.7/117.5
R2251	7030004990	S.RES ERJ2GEJ 221 X (220)	T	6.1/96.9
R2254	7030004990	S.RES ERJ2GEJ 221 X (220)	B	6.8/100.7
R2255	7030004990	S.RES ERJ2GEJ 221 X (220)	B	6.8/101.6
R2256	7030004990	S.RES ERJ2GEJ 221 X (220)	B	6.8/102.5
R2257	7030004990	S.RES ERJ2GEJ 221 X (220)	B	75.3/109
R2258	7030004990	S.RES ERJ2GEJ 221 X (220)	B	70.9/106.5
R2259	7030004990	S.RES ERJ2GEJ 221 X (220)	B	75.3/107.8
R2260	7030004990	S.RES ERJ2GEJ 221 X (220)	B	71/105.6
R2261	7030004990	S.RES ERJ2GEJ 221 X (220)	B	75.3/106.6
R2262	7030004990	S.RES ERJ2GEJ 221 X (220)	B	71.4/104.5
R2263	7030004990	S.RES ERJ2GEJ 221 X (220)	B	75.6/104.5
R2264	7030004990	S.RES ERJ2GEJ 221 X (220)	B	72.2/103.6
R2267	7030004990	S.RES ERJ2GEJ 221 X (220)	T	78.6/104.1
R2268	7030004990	S.RES ERJ2GEJ 221 X (220)	T	78.6/103.2
R2269	7030004990	S.RES ERJ2GEJ 221 X (220)	T	78.6/102.3
R2270	7030004970	S.RES ERJ2GEJ 470 X (47)	T	76.6/101.8
R2271	7030004990	S.RES ERJ2GEJ 221 X (220)	T	76.6/100.9
R2272	7030004990	S.RES ERJ2GEJ 221 X (220)	B	78.1/97.8
R2273	7030004990	S.RES ERJ2GEJ 221 X (220)	B	78.1/98.9
R2274	7030005000	S.RES ERJ2GEJ 471 X (470)	T	14.1/89.7
R2277	7030005090	S.RES ERJ2GEJ 104 X (100K)	T	19.2/89.5
R2278	7030005090	S.RES ERJ2GEJ 104 X (100K)	T	19.2/90.4
R2279	7030005120	S.RES ERJ2GEJ 102 X (1K)	T	66.2/107
R2280	7030004980	S.RES ERJ2GEJ 101 X (100)	B	69.7/110.2
R2281	7030004990	S.RES ERJ2GEJ 221 X (220)	T	7.1/101.5
R2301	7030007250	S.RES ERJ2GEJ 220 X (22)	T	28.3/106.6
R2302	7030008290	S.RES ERJ2GEJ 183 X (18K)	T	28.9/108
R2303	7030005710	S.RES ERJ2GEJ 121 X (120)	T	31.2/110.8
R2304	7030010900	S.RES ERJ3GEVJ 750 V (75)	T	77.7/112
R2311	7030006101	S.RES ERA3YED 183V (18K)	B	67.6/107.1
R2312	7030006571	S.RES ERA3YED 392V (3.9K)	B	68.5/108.3
R2401	7030005000	S.RES ERJ2GEJ 471 X (470)	B	78.7/29.6
R2402	7030005050	S.RES ERJ2GEJ 103 X (10K)	B	81.3/29.6
R2405	7030010040	S.RES ERJ2GEJ-JPW	T	91.9/5.8
R2406	7030004990	S.RES ERJ2GEJ 221 X (220)	B	90.3/100.7
R2408	7030004970	S.RES ERJ2GEJ 470 X (47)	B	90.3/99.8
R2409	7030004990	S.RES ERJ2GEJ 221 X (220)	B	87.1/68.1
R2410	7030004990	S.RES ERJ2GEJ 221 X (220)	B	90.3/65.5
R2411	7030004990	S.RES ERJ2GEJ 221 X (220)	B	87.3/67.2
R2412	7030004990	S.RES ERJ2GEJ 221 X (220)	B	91.3/68.5
R2413	7030004990	S.RES ERJ2GEJ 221 X (220)	B	87.3/66.3
R2414	7030004990	S.RES ERJ2GEJ 221 X (220)	B	90.3/64.6
R2415	7030004990	S.RES ERJ2GEJ 221 X (220)	B	87.3/65.4
R2416	7030004990	S.RES ERJ2GEJ 221 X (220)	B	90.3/63.7
R2417	7030010040	S.RES ERJ2GEJ-JPW	B	51.4/141.2
R2418	7030010040	S.RES ERJ2GEJ-JPW	T	93.7/7.8
R2501	7030005090	S.RES ERJ2GEJ 104 X (100K)	B	8.3/93.3
R2502	7030005090	S.RES ERJ2GEJ 104 X (100K)	B	8/95.1
R2503	7030008410	S.RES ERJ2GEJ 392 X (3.9K)	B	8/91.5
R2505	7030008410	S.RES ERJ2GEJ 392 X (3.9K)	B	10.6/89.2
R2506	7030005720	S.RES ERJ2GEJ 563 X (56K)	B	9.4/90
R2507	7030004980	S.RES ERJ2GEJ 101 X (100)	B	16.4/89.9
R2508	7030005120	S.RES ERJ2GEJ 102 X (1K)	B	10.4/88.3
R2509	7030005120	S.RES ERJ2GEJ 102 X (1K)	B	15.7/88.3
R2510	7030005120	S.RES ERJ2GEJ 102 X (1K)	B	17.4/92.8
R2513	7030005000	S.RES ERJ2GEJ 471 X (470)	B	15.8/94
R2551	7030005120	S.RES ERJ2GEJ 102 X (1K)	B	42.9/123.2
R2552	7030005120	S.RES ERJ2GEJ 102 X (1K)	B	42.9/122.3
R2555	7030004980	S.RES ERJ2GEJ 101 X (100)	B	51.4/119.3
R2556	7030005040	S.RES ERJ2GEJ 472 X (4.7K)	B	44.5/125.2
R2559	7030010040	S.RES ERJ2GEJ-JPW	B	49.5/124.6
R2560	7030008410	S.RES ERJ2GEJ 392 X (3.9K)	B	49.5/125.5
R2561	7030008410	S.RES ERJ2GEJ 392 X (3.9K)	B	52.9/124.7
R2562	7030008410	S.RES ERJ2GEJ 392 X (3.9K)	B	53.9/122.8
R2564	7030005090	S.RES ERJ2GEJ 104 X (100K)	B	46.1/126.1
R2565	7030009280	S.RES ERJ2GEJ 391 X	B	41.8/116.9
R2566	7030005050	S.RES ERJ2GEJ 103 X (10K)	B	59/126.8
R2567	7030005050	S.RES ERJ2GEJ 103 X (10K)	B	60.6/126.8
R2568	7030005040	S.RES ERJ2GEJ 472 X (4.7K)	B	47.8/124.7
R2569	7030005040	S.RES ERJ2GEJ 472 X (4.7K)	B	46.1/125.2
R2601	7030010040	S.RES ERJ2GEJ-JPW	B	66.7/123.4
R2602	7030005000	S.RES ERJ2GEJ 471 X (470)	B	57.2/122.6
R2603	7030005240	S.RES ERJ2GEJ 473 X (47K)	B	63.4/121.7
R2604	7030008400	S.RES ERJ2GEJ 182 X (1.8K)	B	66.7/124.3
R2605	7030005120	S.RES ERJ2GEJ 102 X (1K)	B	65.5/126
R2607	7030010040	S.RES ERJ2GEJ-JPW	T	40.5/132.1
R2608	7030009320	S.RES ERJ2GEJ 4R7 X (4.7)	B	83.9/132.7
R2611	7030005050	S.RES ERJ2GEJ 103 X (10K)	B	33.9/124.8
R2612	7030005090	S.RES ERJ2GEJ 104 X (100K)	B	38.4/125.4
R2613	7030005080	S.RES ERJ2GEJ 823 X (82K)	B	38.4/123.6
R2614	7030005120	S.RES ERJ2GEJ 102 X (1K)	B	34.7/126.6
R2617	7030005040	S.RES ERJ2GEJ 472 X (4.7K)	T	63.3/111.1
R2618	7030007340	S.RES ERJ2GEJ 153 X (15K)	T	69.3/116.3
R2619	7030005060	S.RES ERJ2GEJ 333 X (33K)	T	63.3/112.1
R2620	7030005120	S.RES ERJ2GEJ 102 X (1K)	T	78.1/100.3
R2621	7030005120	S.RES ERJ2GEJ 102 X (1K)	T	78.1/99.4
R2623	7030005240	S.RES ERJ2GEJ 473 X (47K)	T	9.8/112.9
R2624	7030004970	S.RES ERJ2GEJ 470 X (47)	B	86.8/122
R2628	7030005240	S.RES ERJ2GEJ 473 X (47K)	B	61.8/121.7

[MAIN UNIT]

REF NO.	PARTS NO.	DESCRIPTION	M.	H/V LOCATION
C5	4030017460	S.CER ECJ0EB1E102K	B	47.5/30.7
C6	4030018960	S.CER C3216 JB 1C 106MT-N	T	66.3/12
C7	4030017330	S.CER ECJ0EF1C104Z	T	73.1/12.2
C8	4030017330	S.CER ECJ0EF1C104Z	T	77.2/9.1
C9	4030017330	S.CER ECJ0EF1C104Z	T	73.1/14
C10	4030017330	S.CER ECJ0EF1C104Z	T	74.8/14.9
C11	4030017330	S.CER ECJ0EF1C104Z	T	73/17.6
C12	4030017330	S.CER ECJ0EF1C104Z	T	76.4/16.7
C13	4030017330	S.CER ECJ0EF1C104Z	T	72.6/16.7
C14	4030017460	S.CER ECJ0EB1E102K	T	67.7/16.5
C15	4030017460	S.CER ECJ0EB1E102K	T	63.7/14.7
C16	4030017460	S.CER ECJ0EB1E102K	T	63.7/15.6
C17	4030017460	S.CER ECJ0EB1E102K	T	62.3/18.8
C18	4030017620	S.CER ECJ0EC1H100C	T	60.7/18.9
C21	4030017730	S.CER ECJ0EB1E471K	T	64.5/13.8
C25	4030017580	S.CER ECJ0EC1H060C	T	55.2/17.8
C26	4030017660	S.CER ECJ0EC1H330J	T	55.2/18.7
C27	4030017780	S.CER ECJ0EB1E472K	T	51.6/20.5
C28	4030017530	S.CER ECJ0EC1H0R5B	T	53.8/17.1
C29	4030017590	S.CER ECJ0EC1H070C	T	51.7/19.6
C30	4030017730	S.CER ECJ0EB1E471K	T	45.8/17.5
C31	4030017530	S.CER ECJ0EC1H0R5B	T	53.8/16.2
C32	4030017660	S.CER ECJ0EC1H330J	T	52.1/17.4
C33	4030017580	S.CER ECJ0EC1H060C	T	52.2/16.5
C34	4030017380	S.CER ECJ0EC1H050B	T	56/15
C35	4030017380	S.CER ECJ0EC1H050B	T	55.9/12.4
C36	4030017730	S.CER ECJ0EB1E471K	T	51/15.6
C37	4030017780	S.CER ECJ0EB1E472K	T	70.4/11.3
C38	4030017780	S.CER ECJ0EB1E472K	T	45.8/18.4
C40	4030017730	S.CER ECJ0EB1E471K	T	73.1/13.1
C41	4030017730	S.CER ECJ0EB1E471K	T	66.9/19.6
C42	4030017730	S.CER ECJ0EB1E471K	T	70.4/12.2
C43	4030017420	S.CER ECJ0EC1H470J	T	45.8/16.6
C44	4030017420	S.CER ECJ0EC1H470J	T	48/11.7
C50	4030017640	S.CER ECJ0EC1H150J	B	80.4/13.6
C51	4030017640	S.CER ECJ0EC1H150J	B	79.9/11.8
C52	4030017430	S.CER ECJ0EC1H101J	B	79.9/12.7
C53	4030016930	S.CER ECJ0EB1A104K	B	79.6/22
C54	4030016930	S.CER ECJ0EB1A104K	T	79.8/12.9
C55	4030016930	S.CER ECJ0EB1A104K	T	78.1/17.9
C56	4030018860	S.CER ECJ0EB0J105K	B	65.5/22.7
C58	4030017710	S.CER ECJ0EC1H181J	T	72.2/19.4
C59	4030017710	S.CER ECJ0EC1H181J	T	65.4/23.7
C101	4030017330	S.CER ECJ0EF1C104Z	T	10.3/15.5
C102	4030017330	S.CER ECJ0EF1C104Z	T	13.2/16.9
C103	4030017330	S.CER ECJ0EF1C104Z	T	13.2/17.8
C104	4030017330	S.CER ECJ0EF1C104Z	T	3.3/29.9
C105	4030017330	S.CER ECJ0EF1C104Z	T	13.2/19.6
C106	4030017850	S.CER C2012 CH 1H 272J-T	T	23.7/10.9
C107	4030017330	S.CER ECJ0EF1C104Z	T	19.2/12.9
C108	4030017330	S.CER ECJ0EF1C104Z	T	36.5/16.6
C109	4030017330	S.CER ECJ0EF1C104Z	T	25.2/14
C110	4030017800	S.CER C1608 CH 1H 561J-T	T	27.8/7.7
C111	4030018590	S.CER C1608 CH 1H 122J-T	T	29.1/5
C112	4030017330	S.CER ECJ0EF1C104Z	T	23.8/5.3
C114	4030018600	S.CER C1608 CH 1H 152J-T	T	25.1/15
C115	4030008490	S.CER C2012 JB 1H 682K-T	T	24.8/16.7
C116	4030017850	S.CER C2012 CH 1H 272J-T	T	24.8/18.4
C117	4030017330	S.CER ECJ0EF1C104Z	T	19.8/7
C118	4030017330	S.CER ECJ0EF1C104Z	T	38.2/17.5
C119	4030017780	S.CER ECJ0EB1E472K	T	7.8/22.2
C120	4030017330	S.CER ECJ0EF1C104Z	T	7.8/21.3
C121	4030017330	S.CER ECJ0EF1C104Z	T	5.7/12.9
C122	4030017330	S.CER ECJ0EF1C104Z	T	13.2/18.7
C123	4030017330	S.CER ECJ0EF1C104Z	T	15.4/14.3
C124	4030017330	S.CER ECJ0EF1C104Z	T	16.3/15.3
C125	4030017460	S.CER ECJ0EB1E102K	T	40/21.7
C126	4030017460	S.CER ECJ0EB1E102K	T	37/22.3
C127	4030017460	S.CER ECJ0EB1E102K	B	19.2/23
C208	4030017330	S.CER ECJ0EF1C104Z	T	19.7/31.2
C209	4030017680	S.CER ECJ0EC1H820J	T	18.5/41.4
C210	4030017610	S.CER ECJ0EC1H090C	T	18.5/40.5
C211	4030017700	S.CER ECJ0EC1H151J	T	18.5/42.3
C212	4030017650	S.CER ECJ0EC1H270J	T	23.2/39.2
C213	4030017510	S.CER ECJ0EC1H680J	T	21.8/43.4
C214	4030018820	S.CER ECJ0EB1H561K	T	31.7/54.4
C215	4030017440	S.CER ECJ0EC1H221J	T	37/54.6
C226	4030017330	S.CER ECJ0EF1C104Z	T	24.1/43.4
C227	4030017330	S.CER ECJ0EF1C104Z	T	19.7/30.3
C228	4030017430	S.CER ECJ0EC1H101J	T	28.1/39.2
C229	4030017440	S.CER ECJ0EC1H221J	T	29.7/39.2
C237	4030017500	S.CER ECJ0EC1H560J	T	28.1/38.2
C238	4030017330	S.CER ECJ0EF1C104Z	T	21.9/30.9
C239	4030017330	S.CER ECJ0EF1C104Z	B	24.7/41.4
C240	4030017400	S.CER ECJ0EC1H220J	B	28.1/43.6
C241	4030017580	S.CER ECJ0EC1H060C		

[MAIN UNIT]

REF NO.	PARTS NO.	DESCRIPTION	M.	H/V LOCATION
C255	4030018580	S.CER C1608 CH 1H 821J-T	T	32.6/55.9
C256	4030010760	S.CER C1608 CH 1H 331J-T	T	38.1/52.1
C257	4030018610	S.CER C1608 CH 1H 182J-T	T	34.4/53.4
C258	4030017870	S.CER C1608 CH 1H 681J-T	T	40.7/52.2
C259	4030018590	S.CER C1608 CH 1H 122J-T	T	37.1/53.4
C260	4030017870	S.CER C1608 CH 1H 681J-T	T	40.7/47.9
C261	4030017780	S.CER ECJ0EB1E472K	B	37.9/56.2
C262	4030017780	S.CER ECJ0EB1E472K	B	37.9/53.8
C263	4030017330	S.CER ECJ0EF1C104Z	B	24.5/50.2
C264	4030017330	S.CER ECJ0EF1C104Z	B	23.9/47.1
C265	4030011280	S.CER C1608 CH 1H 271J-T	B	36.4/46
C266	4030017700	S.CER ECJ0EC1H151J	B	31/44.1
C267	4030018590	S.CER C1608 CH 1H 122J-T	B	36.4/49.6
C268	4030018580	S.CER C1608 CH 1H 821J-T	B	31.7/42.9
C269	4030017710	S.CER ECJ0EC1H181J	B	36.5/47.1
C270	4030017430	S.CER ECJ0EC1H101J	B	32.6/44.1
C271	4030011330	S.CER C1608 CH 1H 391J-T	B	36.4/48.3
C272	4030011280	S.CER C1608 CH 1H 271J-T	B	36.3/43.8
C273	4030011330	S.CER C1608 CH 1H 391J-T	B	38.8/47.3
C274	4030017730	S.CER ECJ0EB1E471K	B	34.2/43.7
C275	4030017780	S.CER ECJ0EB1E472K	B	42.9/49.6
C276	4030017780	S.CER ECJ0EB1E472K	B	39.2/46.2
C278	4030017330	S.CER ECJ0EF1C104Z	T	30.9/31.8
C279	4030017330	S.CER ECJ0EF1C104Z	T	31/43.8
C281	4030017330	S.CER ECJ0EF1C104Z	T	33/31.7
C282	4030017580	S.CER ECJ0EC1H060C	B	31.5/39.2
C283	4030017330	S.CER ECJ0EF1C104Z	B	35.8/35.8
C284	4030017780	S.CER ECJ0EB1E472K	B	42.6/43.3
C285	4030017380	S.CER ECJ0EC1H050B	B	33.1/39.5
C286	4030017510	S.CER ECJ0EC1H680J	B	34.7/39.5
C287	4030017690	S.CER ECJ0EC1H121J	B	36.5/37.8
C288	4030017680	S.CER ECJ0EC1H820J	B	34.2/36.3
C289	4030017420	S.CER ECJ0EC1H470J	B	36.3/36.7
C290	4030018600	S.CER C1608 CH 1H 152J-T	B	38.8/37.6
C291	4030017680	S.CER ECJ0EC1H820J	B	37.9/36.5
C292	4030017330	S.CER ECJ0EF1C104Z	T	30.9/30
C293	4030017780	S.CER ECJ0EB1E472K	B	38.1/34.8
C294	4030017440	S.CER ECJ0EC1H221J	T	38.6/49.6
C295	4030017510	S.CER ECJ0EC1H680J	T	40.4/51.2
C301	4030017330	S.CER ECJ0EF1C104Z	T	47/30.1
C302	4030017330	S.CER ECJ0EF1C104Z	B	56.1/30.7
C303	4030017330	S.CER ECJ0EF1C104Z	T	51.5/33.6
C305	4030017330	S.CER ECJ0EF1C104Z	T	59.9/34.7
C307	4030017330	S.CER ECJ0EF1C104Z	T	59.9/35.6
C308	4030017330	S.CER ECJ0EF1C104Z	T	60.7/36.5
C309	4030017330	S.CER ECJ0EF1C104Z	T	62.8/36.9
C310	4030017330	S.CER ECJ0EF1C104Z	T	60.9/30.1
C311	4030017330	S.CER ECJ0EF1C104Z	T	50.1/32.6
C312	4030017330	S.CER ECJ0EF1C104Z	T	64.5/36.1
C313	4030017380	S.CER ECJ0EC1H050B	T	46.4/23
C314	4030017660	S.CER ECJ0EC1H330J	T	64.8/35.2
C315	4030017340	S.CER ECJ0EC1H010B	T	49.2/22.9
C316	4030017630	S.CER ECJ0EC1H120J	T	66.1/36.1
C317	4030017600	S.CER ECJ0EC1H080C	T	51.4/23.8
C318	4030017680	S.CER ECJ0EF1H820J	T	66.4/35.2
C319	4030017570	S.CER ECJ0EC1H040B	T	53/24.3
C320	4030017570	S.CER ECJ0EC1H040B	T	69.6/37.1
C321	4030017580	S.CER ECJ0EC1H060C	T	58.6/24.4
C322	4030017670	S.CER ECJ0EC1H390J	T	69/32.2
C323	4030017590	S.CER ECJ0EC1H070C	T	60.4/24.2
C324	4030017330	S.CER ECJ0EF1C104Z	T	74.7/38.6
C325	4030017360	S.CER ECJ0EC1H030B	T	62/24.6
C326	4030017780	S.CER ECJ0EB1E472K	T	47.6/47.1
C401	4030017330	S.CER ECJ0EF1C104Z	T	71/30.8
C413	4030017330	S.CER ECJ0EF1C104Z	T	80.6/23.9
C415	4030017330	S.CER ECJ0EF1C104Z	T	71.9/24
C418	4030017330	S.CER ECJ0EF1C104Z	T	67.4/24.8
C422	4030017330	S.CER ECJ0EF1C104Z	T	80/28.6
C423	4030017330	S.CER ECJ0EF1C104Z	T	67.4/23.9
C424	4030017330	S.CER ECJ0EF1C104Z	T	83.2/21
C425	4030017330	S.CER ECJ0EF1C104Z	T	86.9/27.6
C426	4030017330	S.CER ECJ0EF1C104Z	T	78.6/19.8
C427	4030017330	S.CER ECJ0EF1C104Z	T	80/27.7
C429	4030017460	S.CER ECJ0EB1E102K	T	81.8/25.3
C431	4030017330	S.CER ECJ0EF1C104Z	T	88.5/26.7
C432	4030017780	S.CER ECJ0EB1E472K	B	88.5/19.3
C433	4030017780	S.CER ECJ0EB1E472K	T	88.8/20.3
C434	4030017780	S.CER ECJ0EB1E472K	T	86.7/22.9
C511	4030017460	S.CER ECJ0EB1E102K	T	41.8/26.8
C512	4030017780	S.CER ECJ0EB1E472K	T	93.6/33.5
C513	4030017330	S.CER ECJ0EF1C104Z	T	88.4/28.3
C514	4030017330	S.CER ECJ0EF1C104Z	B	88.3/31.7
C515	4030017780	S.CER ECJ0EB1E472K	T	81.7/33.2
C516	4030017580	S.CER ECJ0EC1H060C	T	86.1/38.7
C518	4030017570	S.CER ECJ0EC1H040B	T	86.9/36.5
C525	4030017330	S.CER ECJ0EF1C104Z	T	81.8/32.3
C526	4030016790	S.CER ECJ0EB1C103K	T	77.9/38.2
C527	4030017330	S.CER ECJ0EF1C104Z	T	79.5/37.9
C528	4030017330	S.CER ECJ0EF1C104Z	T	89.7/35.1
C529	4030017670	S.CER ECJ0EC1H390J	T	91.3/33.8
C530	4030017460	S.CER ECJ0EB1E102K	B	87.7/34.1
C602	4030017570	S.CER ECJ0EC1H040B	B	85.7/39.6
C603	4030017780	S.CER ECJ0EB1E472K	T	89.1/40.1
C604	4030017780	S.CER ECJ0EB1E472K	T	94/46.5
C605	4030017620	S.CER ECJ0EC1H100C	T	86/44.2
C606	4030017620	S.CER ECJ0EC1H100C	B	85.7/41.4
C608	4030017550	S.CER ECJ0EC1H1R5B	B	82.7/43.8
C609	4030017580	S.CER ECJ0EC1H060C	B	78.6/46.8
C610	4030017620	S.CER ECJ0EC1H100C	B	80.7/48.1

[MAIN UNIT]

REF NO.	PARTS NO.	DESCRIPTION	M.	H/V LOCATION
C611	4030017780	S.CER ECJ0EB1E472K	B	85.1/37.5
C612	4030017610	S.CER ECJ0EC1H090C	T	79.5/40.5
C613	4030017620	S.CER ECJ0EC1H100C	T	76.5/43.7
C614	4030017780	S.CER ECJ0EB1E472K	T	69.6/38.8
C615	4030017780	S.CER ECJ0EB1E472K	T	64.3/43
C616	4030017780	S.CER ECJ0EB1E472K	T	77.4/39.5
C617	4030017620	S.CER ECJ0EC1H100C	B	85.7/40.5
C618	4030017620	S.CER ECJ0EC1H100C	B	80.7/49
C701	4030017330	S.CER ECJ0EF1C104Z	T	59/50.6
C702	4030017330	S.CER ECJ0EF1C104Z	T	63/45
C703	4510008630	S.ELE 16 CE 47 FE	B	59/44.9
C704	4030017780	S.CER ECJ0EB1E472K	T	58.6/42.9
C705	4030017600	S.CER ECJ0EC1H080C	T	59.6/45.1
C707	4030017330	S.CER ECJ0EF1C104Z	T	64.2/52.9
C708	4030017460	S.CER ECJ0EB1E102K	T	64.5/55
C709	4030017780	S.CER ECJ0EB1E472K	T	60.7/58.6
C710	4030017780	S.CER ECJ0EB1E472K	T	62.3/58.6
C711	4030017460	S.CER ECJ0EB1E102K	T	57.1/50.6
C712	4030017600	S.CER ECJ0EC1H080C	T	52.4/50.2
C714	4030017460	S.CER ECJ0EB1E102K	T	56.2/49.7
C715	4030017780	S.CER ECJ0EB1E472K	T	52.1/53.2
C716	4030017340	S.CER ECJ0EC1H010B	T	55.3/55.1
C717	4030017780	S.CER ECJ0EB1E472K	T	51.2/52.3
C718	4030017780	S.CER ECJ0EB1E472K	T	56.9/55.1
C719	4030017340	S.CER ECJ0EC1H010B	T	61.1/53.9
C720	4030017380	S.CER ECJ0EC1H050B	T	59.3/42
C721	4030017780	S.CER ECJ0EB1E472K	T	51.2/49.6
C801	4030017330	S.CER ECJ0EF1C104Z	T	71.5/64
C803	4030017780	S.CER ECJ0EB1E472K	T	65.3/61.8
C804	4030017330	S.CER ECJ0EF1C104Z	T	91.9/58
C805	4030017460	S.CER ECJ0EB1E102K	T	83.5/55.8
C807	4030017330	S.CER ECJ0EF1C104Z	T	60.6/66.7
C808	4030017870	S.CER C1608 CH 1H 681J-T	T	60.3/65.5
C809	4030018630	S.CER C2012 CH 1H 472J-T	T	57.4/66.8
C810	4030017700	S.CER ECJ0EC1H151J	T	63.9/68.5
C811	4030017700	S.CER ECJ0EC1H151J	T	63.9/69.4
C812	4030017700	S.CER ECJ0EC1H151J	T	60.1/69.4
C813	4030017700	S.CER ECJ0EC1H151J	T	60.1/68.5
C814	4030017330	S.CER ECJ0EF1C104Z	T	88.5/57.1
C815	4030017460	S.CER ECJ0EB1E102K	T	86.6/60.6
C816	4030017400	S.CER ECJ0EC1H220J	T	85.7/59.7
C817	4030017400	S.CER ECJ0EC1H220J	T	84/61.7
C818	4030018590	S.CER C1608 CH 1H 122J-T	T	54.6/65.6
C819	4030017850	S.CER C2012 CH 1H 272J-T	T	51.6/65.8
C901	4030017330	S.CER ECJ0EF1C104Z	T	38.4/71.3
C910	4030017710	S.CER ECJ0EC1H181J	T	39.2/65.6
C911	4030017700	S.CER ECJ0EC1H151J	T	47.9/74.7
C913	4030017330	S.CER ECJ0EF1C104Z	T	38.2/61.1
C914	4030017330	S.CER ECJ0EF1C104Z	T	39.2/63.6
C916	4030017330	S.CER ECJ0EF1C104Z	T	33.9/61.9
C917	4030017780	S.CER ECJ0EB1E472K	T	35.6/63.2
C918	4030017330	S.CER ECJ0EF1C104Z	T	34.2/67.5
C920	4030017460	S.CER ECJ0EB1E102K	T	38.4/74.2
C921	4030017330	S.CER ECJ0EF1C104Z	T	34.2/70.2
C922	4030017330	S.CER ECJ0EF1C104Z	T	29.4/73
C923	4030017330	S.CER ECJ0EF1C104Z	T	29.9/72.1
C924	4030017780	S.CER ECJ0EB1E472K	T	41.2/74.1
C925	4030017700	S.CER ECJ0EC1H151J	B	31.4/73
C1001	4030017780	S.CER ECJ0EB1E472K	T	31.7/71.2
C1009	4030017780	S.CER ECJ0EB1E472K	T	25.8/72
C1016	4030017330	S.CER ECJ0EF1C104Z	T	25.8/73.8
C1018	4030017460	S.CER ECJ0EB1E102K	T	20.3/76
C1019	4030017330	S.CER ECJ0EF1C104Z	T	15.2/75.7
C1020	4030017330	S.CER ECJ0EF1C104Z	T	12.7/75.8
C1021	4030017330	S.CER ECJ0EF1C104Z	T	4.6/78.9
C1022	4510008630	S.ELE 16 CE 47 FE	B	6.1/86
C1023	4510008630	S.ELE 16 CE 47 FE	B	5.7/77.4
C1101	4030017490	S.CER C1608 JB 1A 105K-T	T	2.5/78.9
C1102	4030017330	S.CER ECJ0EF1C104Z	T	4.6/78
C1104	4030017490	S.CER C1608 JB 1A 105K-T	T	2.5/87.8
C1105	4030018960	S.CER C3216 JB 1C 106MT-N	T	2.9/89.7
C1108	4030017330	S.CER ECJ0EF1C104Z	T	2.3/91.3
C1201	4030017330	S.CER ECJ0EF1C104Z	T	26.6/80.6
C1202	4030017330	S.CER ECJ0EF1C104Z	T	28.7/80.5
C1203	4030017330	S.CER ECJ0EF1C104Z	T	18.6/79.2
C1204	4030018960	S.CER C3216 JB 1C 106MT-N	T	9/76.9
C1206	4030017780	S.CER ECJ0EB1E472K	T	14.3/79.4
C1207	4030017780	S.CER ECJ0EB1E472K	T	12.7/78.5
C1208	4030018800	S.CER ECJ0EB1H182K	T	12.9/85
C1209	4030018820	S.CER ECJ0EB1H561K	T	12.9/84.1
C1210	4030017780	S.CER ECJ0EB1E472K	T	11.3/84.1
C1211	4030017490	S.CER C1608 JB 1A 105K-T	T	9.2/84.5
C1212	4030017490	S.CER C1608 JB 1A 105K-T	T	6.7/87.8
C1213	4030017330	S.CER ECJ0EF1C104Z	T	21.8/78.3
C1301	4030017330	S.CER ECJ0EF1C104Z	T	15.2/73.6
C1302	4030017330	S.CER ECJ0EF1C104Z	T	15.1/67.3
C1303	4030018860	S.CER ECJ0EB0J105K	T	11.3/67.3
C1304	4030017330	S.CER ECJ0EF1C104Z	T	14.3/69.2
C1305	4030017330	S.CER ECJ0EF1C104Z	T	1

[MAIN UNIT]

REF NO.	PARTS NO.	DESCRIPTION	M.	H/V LOCATION
C1404	4030017700	S.CER ECJ0EC1H151J	B	41.9/70.5
C1405	4030017780	S.CER ECJ0EB1E472K	B	43.6/71.4
C1406	4030017780	S.CER ECJ0EB1E472K	B	42/72.4
C1407	4030017780	S.CER ECJ0EB1E472K	B	44.6/74.3
C1408	4030017780	S.CER ECJ0EB1E472K	B	40.3/79
C1409	4030017780	S.CER ECJ0EB1E472K	B	34.7/79
C1411	4030018860	S.CER ECJ0EB0J105K	B	27/79.9
C1412	4030016950	S.CER ECJ0EB1A473K	B	27/80.8
C1413	4030017490	S.CER C1608 JB 1A 105K-T	B	20.7/77.4
C1414	4030016950	S.CER ECJ0EB1A473K	B	25/77.8
C1415	4510008640	S.ELE 6 CE 100 FE	B	13.2/81.2
C1416	4030016950	S.CER ECJ0EB1A473K	B	20.2/78.5
C1418	4030017350	S.CER ECJ0EC1H020B	B	23/86.6
C1419	4030018390	S.CER ECJ0EB1A563K	B	23/87.5
C1420	4030017420	S.CER ECJ0EC1H470J	B	17.8/83
C1421	4030018960	S.CER C3216 JB 1C 106MT-N	B	19.8/87.3
C1422	4030017640	S.CER ECJ0EC1H150J	B	17.8/82.1
C1423	4610001970	S.TRI TZC3P200A110R00	T	3.8/72.5
C1491	4030017670	S.CER ECJ0EC1H390J [EUR]	B	88.2/29.3
	4030017670	S.CER ECJ0EC1H390J [FRA]		
	4030017670	S.CER ECJ0EC1H390J [ESP]		
	4030017400	S.CER ECJ0EC1H220J [USA]		
	4030017670	S.CER ECJ0EC1H390J [EXP]		
	4030017670	S.CER ECJ0EC1H390J [ITR]		
	4030017670	S.CER ECJ0EC1H390J [UK]		
	4030017400	S.CER ECJ0EC1H220J [KOR]		
	4030017670	S.CER ECJ0EC1H390J [AUS]		
	4030017670	S.CER ECJ0EC1H390J [CHN]		
C1493	4030017660	S.CER ECJ0EC1H330J	B	86.1/33.7
C1494	4030017670	S.CER ECJ0EC1H390J [EUR]	B	83.6/34
	4030017670	S.CER ECJ0EC1H390J [FRA]		
	4030017670	S.CER ECJ0EC1H390J [ESP]		
	4030017420	S.CER ECJ0EC1H470J [USA]		
	4030017670	S.CER ECJ0EC1H390J [EXP]		
	4030017670	S.CER ECJ0EC1H390J [ITR]		
	4030017670	S.CER ECJ0EC1H390J [UK]		
	4030017420	S.CER ECJ0EC1H470J [KOR]		
	4030017670	S.CER ECJ0EC1H390J [AUS]		
	4030017670	S.CER ECJ0EC1H390J [CHN]		
C1495	4030011280	S.CER C1608 CH 1H 271J-T [EUR]	B	84/32.9
	4030011280	S.CER C1608 CH 1H 271J-T [FRA]		
	4030011280	S.CER C1608 CH 1H 271J-T [ESP]		
	4030010760	S.CER C1608 CH 1H 331J-T [USA]		
	4030011280	S.CER C1608 CH 1H 271J-T [EXP]		
	4030011280	S.CER C1608 CH 1H 271J-T [ITR]		
	4030011280	S.CER C1608 CH 1H 271J-T [UK]		
	4030010760	S.CER C1608 CH 1H 331J-T [KOR]		
	4030011280	S.CER C1608 CH 1H 271J-T [AUS]		
	4030011280	S.CER C1608 CH 1H 271J-T [CHN]		
C1496	4030017660	S.CER ECJ0EC1H330J	B	79.3/35.3
C1498	4030017670	S.CER ECJ0EC1H390J [EUR]	B	79.3/36.2
	4030017670	S.CER ECJ0EC1H390J [FRA]		
	4030017670	S.CER ECJ0EC1H390J [ESP]		
	4030017400	S.CER ECJ0EC1H220J [USA]		
	4030017670	S.CER ECJ0EC1H390J [EXP]		
	4030017670	S.CER ECJ0EC1H390J [ITR]		
	4030017670	S.CER ECJ0EC1H390J [UK]		
	4030017400	S.CER ECJ0EC1H220J [KOR]		
	4030017670	S.CER ECJ0EC1H390J [AUS]		
	4030017670	S.CER ECJ0EC1H390J [CHN]		
C1501	4030017410	S.CER ECJ0EC1H240J	B	79.3/37.1
C1503	4030017330	S.CER ECJ0EF1C104Z	B	78.9/61.9
C1504	4030017510	S.CER ECJ0EB1H680J	B	80.9/36.4
C1506	4030017780	S.CER ECJ0EB1E472K	B	92.1/28.8
C1507	4030017410	S.CER ECJ0EC1H240J	B	82.5/36.4
C1508	4030017780	S.CER ECJ0EB1E472K	B	77.3/38.6
C1509	4030017780	S.CER ECJ0EB1E472K	B	72.4/39.1
C1510	4030017780	S.CER ECJ0EB1E472K	B	72.4/41.2
C1511	4030016790	S.CER ECJ0EB1C103K	B	86.4/56.2
C1512	4030017780	S.CER ECJ0EB1E472K	B	77/41.6
C1513	4030018900	S.CER ECJ0EB0J474K	B	73.6/55.1
C1514	4030017780	S.CER ECJ0EB1E472K	B	73.5/42.1
C1515	4030018960	S.CER C3216 JB 1C 106MT-N	B	68.3/53.7
C1516	4030017330	S.CER ECJ0EF1C104Z	B	77.3/49
C1517	4030017730	S.CER ECJ0EB1E471K	B	73.4/53.9
C1518	4030016790	S.CER ECJ0EB1C103K	B	85.7/51.4
C1519	4030018960	S.CER C3216 JB 1C 106MT-N	B	69.3/47.4
C1520	4510008630	S.ELE 16 CE 47 FE	B	91/45.4
C1521	4030017680	S.CER ECJ0EC1H820J	B	85.9/58
C1522	4030017670	S.CER ECJ0EC1H390J	T	73.2/55.3
C1523	4030017330	S.CER ECJ0EF1C104Z	T	31.2/80.4
C1524	4030017420	S.CER ECJ0EC1H470J [EUR]	B	73.6/60.5
	4030017420	S.CER ECJ0EC1H470J [FRA]		
	4030017420	S.CER ECJ0EC1H470J [ESP]		
	4030017510	S.CER ECJ0EC1H680J [USA]		
	4030017420	S.CER ECJ0EC1H470J [EXP]		
	4030017420	S.CER ECJ0EC1H470J [ITR]		
	4030017420	S.CER ECJ0EC1H470J [UK]		
	4030017510	S.CER ECJ0EC1H680J [KOR]		
	4030017420	S.CER ECJ0EC1H470J [AUS]		
	4030017420	S.CER ECJ0EC1H470J [CHN]		
C1525	4030018900	S.CER ECJ0EB0J474K	B	85.8/59.9
C1526	4030018960	S.CER C3216 JB 1C 106MT-N	B	69.3/51.5
C1531	4030017490	S.CER C1608 JB 1A 105K-T	B	82.8/48.3
C1532	4030017780	S.CER ECJ0EB1E472K	B	81.9/41.3
C1533	4030017780	S.CER ECJ0EB1E472K	B	81.9/39.4
C1534	4030017780	S.CER ECJ0EB1E472K	B	83.5/38.5
C1601	4030017780	S.CER ECJ0EB1E472K	T	6.3/52.2
C1604	4030017780	S.CER ECJ0EB1E472K	T	5.6/50.8

[MAIN UNIT]

REF NO.	PARTS NO.	DESCRIPTION	M.	H/V LOCATION
C1605	4030017330	S.CER ECJ0EF1C104Z	T	8.8/48.7
C1607	4030017780	S.CER ECJ0EB1E472K	T	14.7/46
C1609	4030017490	S.CER C1608 JB 1A 105K-T	T	14.1/33.6
C1610	4030017330	S.CER ECJ0EF1C104Z	T	12.1/44.7
C1611	4030017330	S.CER ECJ0EF1C104Z	T	14.6/41.1
C1613	4030017330	S.CER ECJ0EF1C104Z	T	18.9/47.1
C1614	4030017730	S.CER ECJ0EB1E471K	T	15/36.1
C1615	4030017420	S.CER ECJ0EC1H470J	T	10.4/46.9
C1616	4550007260	S.TAN F931C475MAABMA	T	9.6/50.5
C1618	4030017430	S.CER ECJ0EC1H101J	T	12.7/26.3
C1701	4030017490	S.CER C1608 JB 1A 105K-T	B	55.1/50.4
C1702	4030017490	S.CER C1608 JB 1A 105K-T	B	55/69.6
C1801	4030017330	S.CER ECJ0EF1C104Z	B	18.4/105
C1802	4510008630	S.ELE 16 CE 47 FE	B	14.4/101.2
C1803	4030018960	S.CER C3216 JB 1C 106MT-N	B	22.3/112.1
C1804	4030017330	S.CER ECJ0EF1C104Z	B	22.8/110.6
C1901	4030017330	S.CER ECJ0EF1C104Z	T	36.2/80.4
C1902	4030017330	S.CER ECJ0EF1C104Z	T	33.7/80.4
C1903	4030017330	S.CER ECJ0EF1C104Z	B	23.3/18.8
C1904	4030017330	S.CER ECJ0EF1C104Z	B	32.5/89.8
C1905	4030017330	S.CER ECJ0EF1C104Z	B	25.9/33.8
C1906	4030017330	S.CER ECJ0EF1C104Z	B	25.9/32.9
C1907	4030017330	S.CER ECJ0EF1C104Z	T	41.6/80.3
C1908	4030017330	S.CER ECJ0EF1C104Z	T	38.4/80.7
C1909	4030017330	S.CER ECJ0EF1C104Z	B	21.6/13.9
C1910	4030017460	S.CER ECJ0EB1E102K	B	45.4/25.4
C1916	4030018960	S.CER C3216 JB 1C 106MT-N	B	14.7/50.5
C1917	4030018960	S.CER C3216 JB 1C 106MT-N	B	5.3/52.7
C1951	4030018960	S.CER C3216 JB 1C 106MT-N	B	48.1/103.1
C1952	4030018960	S.CER C3216 JB 1C 106MT-N	B	48.1/98.9
C1953	4030018960	S.CER C3216 JB 1C 106MT-N	B	48.1/96.8
C1954	4030018960	S.CER C3216 JB 1C 106MT-N	B	48.6/105.2
C1955	4030018960	S.CER C3216 JB 1C 106MT-N	B	48.1/101
C1956	4030018960	S.CER C3216 JB 1C 106MT-N	B	60.9/118.7
C1957	4030017330	S.CER ECJ0EF1C104Z	B	63.8/116.7
C1958	4030018910	S.CER C1608 JB 0J 475K-T	B	20.9/125.7
C1959	4550007090	S.TAN TEESVA 1A 226M8R	B	11.6/120.2
C1960	4030010210	S.CER C3216 JB 1C 105M-T	B	47.3/109.7
C1961	4030017730	S.CER ECJ0EB1E471K	B	44/110
C1962	4030017440	S.CER ECJ0EC1H221J	B	44.6/108.4
C1963	4030017500	S.CER ECJ0EC1H560J	B	35.3/105.1
C1964	4030017330	S.CER ECJ0EF1C104Z	B	44.3/111.3
C1965	4030018960	S.CER C3216 JB 1C 106MT-N	B	7.4/108
C1966	4030017330	S.CER ECJ0EF1C104Z	B	10.1/103
C1968	4030018960	S.CER C3216 JB 1C 106MT-N	B	31.7/103.6
C1969	4030018970	S.CER C3225 JB 1C 226MT-N	B	30.8/100.9
C1970	4030018970	S.CER C3225 JB 1C 226MT-N	B	30.8/97.9
C1971	4030017330	S.CER ECJ0EF1C104Z	B	45.9/111.3
C1972	4030017330	S.CER ECJ0EF1C104Z	B	47.6/106.7
C1973	4030017330	S.CER ECJ0EF1C104Z	B	32.1/105.1
C2001	4030017780	S.CER ECJ0EB1E472K	T	33.2/10.3
C2002	4030017330	S.CER ECJ0EF1C104Z	B	71.7/14.6
C2003	4030017780	S.CER ECJ0EB1E472K	B	58.8/15.8
C2004	4030017780	S.CER ECJ0EB1E472K	B	83/5.9
C2005	4030017780	S.CER ECJ0EB1E472K	B	69/16.4
C2006	4030017330	S.CER ECJ0EF1C104Z	B	83/6.8
C2007	4030017780	S.CER ECJ0EB1E472K	B	84.6/5.9
C2008	4030017330	S.CER ECJ0EF1C104Z	B	56.7/10.1
C2009	4030017330	S.CER ECJ0EF1C104Z	B	75.4/18.6
C2010	4030017780	S.CER ECJ0EB1E472K	B	75.6/6.6
C2011	4030017330	S.CER ECJ0EF1C104Z	B	75/7.7
C2012	4030017780	S.CER ECJ0EB1E472K	B	63.1/15.5
C2013	4030017330	S.CER ECJ0EF1C104Z	B	88.9/2
C2014	4030017780	S.CER ECJ0EB1E472K	B	32.5/11.8
C2015	4030017780	S.CER ECJ0EB1E472K	B	32.5/12.7
C2016	4030017780	S.CER ECJ0EB1E472K	B	19/131.2
C2017	4030017330	S.CER ECJ0EF1C104Z	T	86.4/10.2
C2018	4030017780	S.CER ECJ0EB1E472K	B	42.7/17.7
C2019	4030017780	S.CER ECJ0EB1E472K	T	24.7/126.7
C2020	4030017330	S.CER ECJ0EF1C104Z	B	84.1/23.1
C2021	4030017780	S.CER ECJ0EB1E472K	B	32.5/16
C2022	4030017780	S.CER ECJ0EB1E472K	B	30.3/130.2
C2024	4030017780	S.CER ECJ0EB1E472K	B	28.7/128.2
C2025	4030017780	S.CER ECJ0EB1E472K	B	45/12.5
C2026	4030018960	S.CER C3216 JB 1C 106MT-N	B	10.1/23.4
C2027	4030018960	S.CER C3216 JB 1C 106MT-N	B	10.1/14.6
C2028	4030017330	S.CER ECJ0EF1C104Z	B	51.7/12.7
C2029	4030017330	S.CER ECJ0EF1C104Z	B	58.1/9.4
C2030	4030017330	S.CER ECJ0EF1C104Z	B	55.8/15.8
C2032	4030017780	S.CER ECJ0EB1E472K	B	27.4/129
C2033	4030017330	S.CER ECJ0EF1C104Z	B	71.1/21.9
C2034	4030017780	S.CER ECJ0EB1E472K	B	64.8/5.6
C2035	4030017780	S.CER ECJ0EB1E472K	B	25.6/130.2
C2036	4030017330	S.CER ECJ0EF1C104Z	B	88.2/8
C2037	4030017330	S.CER ECJ0EF1C104Z	B	76.4/16.6
C2038	4030017780	S.CER ECJ0EB1E472K	T	14.5/126.4
C2039	4030017780	S.CER ECJ0EB1E472K	B	80.2/6.7
C2040	4030017780	S.CER ECJ0EB1E472K	B	64.6/17.7
C2041	4030017330	S.CER ECJ0EF1C104Z	B	75.2/10.5
C2042	4030017330	S.CER ECJ0EF1C104Z	B	62.7/18.1
C2043	4030017780	S.CER ECJ0EB1E472K	B	55.4/8.8
C2044	4030017780	S.CER ECJ0EB1E472K	B	62.7/19.5
C2045	4030017780	S.CER ECJ0EB1E472K	B	64.3/21.8
C2046	4030017780	S.CER ECJ0EB1E472K	B	63.6/14.6

[MAIN UNIT]

REF NO.	PARTS NO.	DESCRIPTION	M.	H/V LOCATION
C2052	4030017780	S.CER ECJ0EB1E472K	T	21.6/108
C2053	4030017780	S.CER ECJ0EB1E472K	T	49.8/107.5
C2054	4030018960	S.CER C3216 JB 1C 106MT-N	B	55.3/83.4
C2055	4030018960	S.CER C3216 JB 1C 106MT-N	B	28.1/88.5
C2058	4030018960	S.CER C3216 JB 1C 106MT-N	B	16.4/95.5
C2062	4550007710	S.TAN TEESVBE 1A 476M8R	B	26.6/13
C2063	4030017730	S.CER ECJ0EB1E471K	B	46/13.7
C2064	4030018960	S.CER C3216 JB 1C 106MT-N	B	61.1/23
C2065	4030016930	S.CER ECJ0EB1A104K	B	73.3/1.2
C2066	4030016930	S.CER ECJ0EB1A104K	B	75.1/1.2
C2067	4030017430	S.CER ECJ0EC1H101J	B	56.9/19.9
C2068	4030017460	S.CER ECJ0EB1E102K	B	59.1/26.1
C2069	4030017730	S.CER ECJ0EB1E471K	B	46.6/12.1
C2101	4030017330	S.CER ECJ0EF1C104Z	T	28.3/113.8
C2102	4030017330	S.CER ECJ0EF1C104Z	T	44.7/110.9
C2103	4030018960	S.CER C3216 JB 1C 106MT-N	T	28.8/112.2
C2104	4030017330	S.CER ECJ0EF1C104Z	T	56.1/123.5
C2105	4030018960	S.CER C3216 JB 1C 106MT-N	T	54.7/125
C2156	4030017330	S.CER ECJ0EF1C104Z	T	36.2/122.1
C2157	4030017330	S.CER ECJ0EF1C104Z	B	34.4/91
C2158	4030017330	S.CER ECJ0EF1C104Z	B	27.4/93.7
C2159	4030017330	S.CER ECJ0EF1C104Z	T	22.4/94.4
C2160	4030017330	S.CER ECJ0EF1C104Z	B	38.2/88.8
C2161	4030018960	S.CER C3216 JB 1C 106MT-N	T	36.8/123.6
C2162	4030018960	S.CER C3216 JB 1C 106MT-N	B	37.7/90.4
C2163	4030017780	S.CER ECJ0EB1E472K	T	4.6/116.5
C2164	4030018960	S.CER C3216 JB 1C 106MT-N	T	6.5/114.9
C2166	4030012610	S.CER C2012 JB 1C 474K-T	T	5.2/106.8
C2167	4030018960	S.CER C3216 JB 1C 106MT-N	T	4.9/109.9
C2168	4030012610	S.CER C2012 JB 1C 474K-T	T	16.5/116.8
C2169	4030016930	S.CER ECJ0EB1A104K	T	14/124.2
C2201	4030017780	S.CER ECJ0EB1E472K	T	24.7/125.8
C2203	4030018520	S.CER C1608 JB 0J 225M-T	T	16/118.4
C2204	4030017330	S.CER ECJ0EF1C104Z	T	11.1/119.7
C2205	4030018960	S.CER C3216 JB 1C 106MT-N	T	12.4/117.1
C2206	4030017780	S.CER ECJ0EB1E472K	T	21.7/115.6
C2208	4030017730	S.CER ECJ0EB1E471K	T	19/116.9
C2211	4030018960	S.CER C3216 JB 1C 106MT-N	T	22.4/119.9
C2212	4030018960	S.CER C3216 JB 1C 106MT-N	T	23.2/124.3
C2213	4550007140	S.TAN TEESVD 1C 107M12R	T	37.6/138.5
C2214	4030018910	S.CER C1608 JB 0J 475K-T	T	20.9/122.6
C2231	4030017330	S.CER ECJ0EF1C104Z	T	38.2/105.6
C2232	4030018960	S.CER C3216 JB 1C 106MT-N	T	38.1/104
C2233	4030017780	S.CER ECJ0EB1E472K	T	4.7/123.2
C2234	4550007310	S.TAN F930J227MNBMA	T	70.1/130.6
C2235	4030018960	S.CER C3216 JB 1C 106MT-N	T	40.9/108.8
C2236	4030018960	S.CER C3216 JB 1C 106MT-N	T	39.8/111.1
C2237	4030017460	S.CER ECJ0EB1E102K	T	60.6/123.3
C2254	4030017330	S.CER ECJ0EF1C104Z	T	7.6/92.5
C2255	4030017330	S.CER ECJ0EF1C104Z	B	2.4/98.1
C2256	4030017330	S.CER ECJ0EF1C104Z	B	2.6/95.6
C2257	4030017330	S.CER ECJ0EF1C104Z	T	9.9/87.9
C2260	4030017330	S.CER ECJ0EF1C104Z	T	18.5/103.6
C2261	4030017330	S.CER ECJ0EF1C104Z	T	6.7/104.4
C2262	4030017330	S.CER ECJ0EF1C104Z	T	58.5/100.3
C2264	4030017330	S.CER ECJ0EF1C104Z	T	61.8/88.9
C2266	4030017330	S.CER ECJ0EF1C104Z	T	72/85.2
C2268	4030017330	S.CER ECJ0EF1C104Z	T	68.5/89.4
C2269	4030017330	S.CER ECJ0EF1C104Z	B	78.4/92.4
C2270	4030017780	S.CER ECJ0EB1E472K	T	61.8/89.8
C2272	4030017330	S.CER ECJ0EF1C104Z	T	56.2/92.2
C2274	4030017330	S.CER ECJ0EF1C104Z	T	55.8/95
C2275	4030017330	S.CER ECJ0EF1C104Z	B	68.1/99.3
C2276	4030017330	S.CER ECJ0EF1C104Z	B	64.2/100.6
C2277	4030017330	S.CER ECJ0EF1C104Z	T	63.6/103.4
C2278	4030017330	S.CER ECJ0EF1C104Z	T	63.6/107.9
C2279	4030017330	S.CER ECJ0EF1C104Z	T	62.7/108.8
C2280	4030017420	S.CER ECJ0EC1H470J	T	51.8/37.9
C2281	4030017330	S.CER ECJ0EF1C104Z	T	68.5/90.3
C2282	4030017330	S.CER ECJ0EF1C104Z	B	80.4/93
C2283	4030017330	S.CER ECJ0EF1C104Z	B	81.6/92.1
C2285	4030017330	S.CER ECJ0EF1C104Z	T	50.8/99
C2286	4030017330	S.CER ECJ0EF1C104Z	T	14.1/88.8
C2301	4030018910	S.CER C1608 JB 0J 475K-T	T	30.8/106.9
C2302	4030018910	S.CER C1608 JB 0J 475K-T	T	27.8/109.4
C2303	4550007310	S.TAN F930J227MNBMA	T	84.4/110.3
C2311	4030017330	S.CER ECJ0EF1C104Z	B	68.1/110.2
C2312	4030018910	S.CER C1608 JB 0J 475K-T	B	67.3/104.9
C2401	4030017330	S.CER ECJ0EF1C104Z	B	90.8/103.8
C2402	4030017330	S.CER ECJ0EF1C104Z	B	81.2/100.7
C2403	4030017780	S.CER ECJ0EB1E472K	B	77.2/28.8
C2405	4030017330	S.CER ECJ0EF1C104Z	T	74.2/79.3
C2406	4030017460	S.CER ECJ0EB1E102K	B	88.5/99.7
C2407	4030017330	S.CER ECJ0EF1C104Z	T	74.1/78.2
C2408	4030017330	S.CER ECJ0EF1C104Z	B	84.9/96.1
C2409	4030017330	S.CER ECJ0EF1C104Z	T	75.6/77.6
C2410	4030017330	S.CER ECJ0EF1C104Z	B	88.5/85.8
C2411	4030017330	S.CER ECJ0EF1C104Z	B	81.1/96.4
C2412	4510008630	S.ELE 16 CE 47 FE	B	62.1/30.4
C2413	4030017330	S.CER ECJ0EF1C104Z	B	88.5/93.7
C2414	4030017780	S.CER ECJ0EB1E472K	T	84/95.6
C2415	4030017780	S.CER ECJ0EB1E472K	B	88.3/28
C2417	4030017330	S.CER ECJ0EF1C104Z	B	88.3/27.1
C2418	4030017330	S.CER ECJ0EF1C104Z	B	82.6/94
C2419	4030017330	S.CER ECJ0EF1C104Z	B	88.5/86.7
C2422	4030017330	S.CER ECJ0EF1C104Z	T	84.8/87.3
C2423	4030017420	S.CER ECJ0EC1H470J	B	62.1/141.2
C2424	4510008630	S.ELE 16 CE 47 FE	B	69.2/31.3
C2426	4030017330	S.CER ECJ0EF1C104Z	B	68.8/82.1

[MAIN UNIT]

REF NO.	PARTS NO.	DESCRIPTION	M.	H/V LOCATION
C2427	4030012600	S.CER C2012 JB 1A 105M-T	T	85.1/91.4
C2501	4030017330	S.CER ECJ0EF1C104Z	B	8/94.2
C2502	4030018960	S.CER C3216 JB 1C 106MT-N	B	11.5/95.2
C2503	4030016970	S.CER ECJ0EB1C223K	B	14.9/89.3
C2505	4030016940	S.CER ECJ0EB1A393K	B	17.4/91.4
C2506	4030017780	S.CER ECJ0EB1E472K	B	18.2/93.8
C2507	4030017490	S.CER C1608 JB 1A 105K-T	B	12.7/89.2
C2551	4030017330	S.CER ECJ0EF1C104Z	B	42.9/124.1
C2552	4030018960	S.CER C3216 JB 1C 106MT-N	B	47.8/118.8
C2553	4030016970	S.CER ECJ0EB1C223K	B	51.3/124.7
C2554	4030018390	S.CER ECJ0EB1A563K	B	53.9/121.9
C2555	4030017760	S.CER ECJ0EB1H222K	B	53.9/121
C2556	4030017770	S.CER ECJ0EB1E332K	B	52.8/123.8
C2557	4030017330	S.CER ECJ0EF1C104Z	B	41.7/120.8
C2558	4030018960	S.CER C3216 JB 1C 106MT-N	B	42.9/118.4
C2561	4030018960	S.CER C3216 JB 1C 106MT-N	B	56.5/124.3
C2562	4030018960	S.CER C3216 JB 1C 106MT-N	B	53.4/126.4
C2563	4550007110	S.TAN SY6-1A107M-RC	B	75.3/122.8
C2564	4030018080	S.CER ECJ0EB1H182K	B	47.8/125.6
C2565	4030017430	S.CER ECJ0EC1H101J	B	44.6/122.6
C2566	4030018090	S.CER ECJ0EB1C822K	B	46.2/124.3
C2601	4030017330	S.CER ECJ0EF1C104Z	B	59.7/125.1
C2603	4030010210	S.CER C3216 JB 1C 105M-T	B	87.5/126
C2604	4030016970	S.CER ECJ0EB1C223K	B	89.1/128.6
C2605	4030017330	S.CER ECJ0EF1C104Z	B	83.9/133.7
C2606	4510009250	S.ELE EEEFK1C471P	T	69.2/137.4
C2607	4510008650	S.ELE EEEFK1C221P	T	58.5/138.3
C2608	4030017330	S.CER ECJ0EF1C104Z	B	87.5/128.6
C2610	4510009250	S.ELE EEEFK1C471P	T	6.2/65.3
C2612	4030017330	S.CER ECJ0EF1C104Z	B	33.9/123.9
C2613	4510009250	S.ELE EEEFK1C471P	T	31.7/131.5
C2616	4030017780	S.CER ECJ0EB1E472K	B	31.6/134.3
C2617	4030017780	S.CER ECJ0EB1E472K	T	33.5/126
C2618	4030017430	S.CER ECJ0EC1H101J	B	31.6/133.4
C2619	4030017780	S.CER ECJ0EB1E472K	T	67.7/112.6
C2620	4510008630	S.ELE 16 CE 47 FE	B	82.9/119.1
C2621	4510008500	S.ELE EEE1CA101WP	T	49.2/138.3
C2622	4510008500	S.ELE EEE1CA101WP	T	60.1/130.4
C2624	4030017330	S.CER ECJ0EF1C104Z	B	38.4/124.5
CP1601	6910009670	S.CHE HK3-S-T	T	11.7/54.7
J1	6510007020	CON TMP-J01X-V6		
J101	6510007020	CON TMP-J01X-V6		
J401	6510007020	CON TMP-J01X-V6		
J801	6510007020	CON TMP-J01X-V6		
J2002	6510019971	S.CON 52808-1071	T	39/12.6
J2003	6510024861	S.CON 5406721-2	T	18.7/137.8
J2004	6510023511	S.CON 28FLT-SM2-TB(LF)(SN) 2	T	82.4/4.9
J2005	6510023511	S.CON 28FLT-SM2-TB(LF)(SN) 2	T	66/4.9
J2231	6510018961	S.CON B2B-PH-SM4-TF(LF)(SN)	T	51.6/129.5
J2251	6510022881	S.CON AXK5S30347YG	T	12.3/96.6
J2252	6510024820	S.CON AXK5S60340P 2	T	72.4/101.1
J2401	6510025770	S.CON 03-935H0-72BKA	B	57.7/136.6
J2402	6510025770	S.CON 03-935H0-72BKA	B	47/136.6
J2403	6510019371	S.CON B3B-ZR-SM4-TF(LF)(SN)	T	94.8/1.8
J2405	6510024880	S.CON 52689-3087	T	90.3/93.8
J2406	6510024880	S.CON 52689-3087	T	90.3/70.9
J2407	6510025770	S.CON 03-935H0-72BKA	B	68.4/136.6
J2601	6510014961	S.CON B2B-ZR-SM4-TF(LF)(SN)	T	42.6/128.8
J2602	6510025770	S.CON 03-935H0-72BKA	B	36.3/136.6
W1	9029701008	WIR 72/98/020/X98/X98		
W601	9029701008	WIR 72/98/020/X98/X98		
EP104	6910012350	S.BEA MMZ1608Y 102BT	T	61.2/28.2
EP511	6910012350	S.BEA MMZ1608Y 102BT	T	44.1/26.5
EP1951	6910014730	S.BEA MPZ2012S331A-T	B	61.3/116.7
EP1952	6910014730	S.BEA MPZ2012S331A-T	B	26.8/113.3
EP1953	6910014730	S.BEA MPZ2012S331A-T	B	9.9/104.5
EP1954	6910014730	S.BEA MPZ2012S331A-T	B	50.3/107.3
EP2001	6910012350	S.BEA MMZ1608Y 102BT	B	74.2/5.3
EP2002	6910012350	S.BEA MMZ1608Y 102BT	B	34.7/12.6
EP2003	6910012350	S.BEA MMZ1608Y 102BT	B	33.5/13.8
EP2004	6910012350	S.BEA MMZ1608Y 102BT	B	39.5/15.9
EP2006	6910014730	S.BEA MPZ2012S331A-T	B	42.2/13.3
EP2007	6910012350	S.BEA MMZ1608Y 102BT	B	45.2/11
EP2008	6910012350	S.BEA MMZ1608Y 102BT	B	45.1/14.8
EP2231	6910012350	S.BEA MMZ1608Y 102BT	T	59.8/125.7
EP2251	6910012350	S.BEA MMZ1608Y 102BT	T	4.5/95.5
EP2252	6910012350	S.BEA MMZ1608Y 102BT	T	7.5/95.8
EP2253	6910012350	S.BEA MMZ1608Y 102BT	T	66.1/109.3
EP2254	6910012350	S.BEA MMZ1608Y 102BT	T	65.7/108.1
EP2255	6910012350	S.BEA MMZ1608Y 102BT	T	17.8/101.5
EP2256	6910012350	S.BEA MMZ1608Y 102BT	T	65.1/106
EP2257	6910012350	S.BEA MMZ1608Y 102BT	T	65.1/104.8
EP2258	6910012350	S.BEA MMZ1608Y 102BT	B	77.9/93.4
EP2259	6910012350	S.BEA MMZ1608Y 102BT	B	68.1/1

[MAIN UNIT]

REF NO.	PARTS NO.	DESCRIPTION	M.	H/V LOCATION
EP2271	6910012350	S.BEA MMZ1608Y 102BT	T	74.6/91.1
EP2402	6910012350	S.BEA MMZ1608Y 102BT	B	51.1/129.6
EP2403	6910012350	S.BEA MMZ1608Y 102BT	B	48.4/129.6
EP2404	6910012350	S.BEA MMZ1608Y 102BT	B	68.5/129.3
EP2405	6910012350	S.BEA MMZ1608Y 102BT	B	62.1/134.9
EP2408	6910012350	S.BEA MMZ1608Y 102BT	B	91.3/102.7
EP2409	6910012350	S.BEA MMZ1608Y 102BT	T	85.3/101.2
EP2410	6910012350	S.BEA MMZ1608Y 102BT	T	84.7/98.3
EP2411	6910012350	S.BEA MMZ1608Y 102BT	T	85.2/79.2
EP2412	6910012350	S.BEA MMZ1608Y 102BT	T	82.5/78.4
EP2413	6910012350	S.BEA MMZ1608Y 102BT	B	72.4/129.3
EP2414	6910012350	S.BEA MMZ1608Y 102BT	B	89.3/91
EP2415	6910012350	S.BEA MMZ1608Y 102BT	T	84.9/100
EP2416	6910012350	S.BEA MMZ1608Y 102BT	T	80/77.6
EP2417	6910012350	S.BEA MMZ1608Y 102BT	B	87.2/78.8
EP2602	6910014730	S.BEA MPZ2012S331A-T	T	35.9/125.6
EP2604	6910014730	S.BEA MPZ2012S331A-T	B	31.6/135.7
EP2605	6910014730	S.BEA MPZ2012S331A-T	T	42.9/135.4
EP2606	6910014730	S.BEA MPZ2012S331A-T	T	41.3/133.7
MP201	8510017210	PLA 2427 B-SHIELD PLATE Y801	B	23.1/59.8
W101	8970024640	CBL 1.5D175MM C24/C31		
W401	8970024650	CBL 1.5D 200MM (SX2427 A5-6G1)		

[PA UNIT]

REF NO.	PARTS NO.	DESCRIPTION	M.	H/V LOCATION
IC471	1110005630	S.IC UPC3215TB-E3-A	B	67.6/96.4
IC701	1180002010	S.REG BA08FP-E2	B	126.3/41.9
IC960	1110002700	S.IC NJM2904M-TE1-#FMZB	B	41/132.1
IC981	1130012720	S.IC CD74HC4094PWR	T	26.2/5.9
Q101	1560001091	S.FET 2SK2854(T2LICOM,F)	T	149.2/28.5
Q102	1560001241	S.FET RD01MUS1-T113	T	146/40.1
Q301	1560001391	FET RD70HHF1-101		
Q302	1560001391	FET RD70HHF1-101		
Q401	1560001401	FET RD60HUF1-101		
Q402	1590000680	S.TRA DTC114EUA T106	B	87.7/132.8
Q403	1590000680	S.TRA DTC114EUA T106	B	90/130.3
Q451	1580000691	S.FET 3SK291(TE85R,F)	B	76.7/108.3
Q452	1590003940	S.TRA RN1105(TE85L,F)	B	67.5/115.8
Q453	1590003940	S.TRA RN1105(TE85L,F)	B	75.1/119.8
Q501	1560001591	FET RD70HVF1C-121		
Q502	1590000680	S.TRA DTC114EUA T106	T	87.7/107.5
Q503	1590000680	S.TRA DTC114EUA T106	T	87.7/110
Q551	1580000691	S.FET 3SK291(TE85R,F)	T	68.4/108.9
Q552	1590003940	S.TRA RN1105(TE85L,F)	T	63/110.1
Q700	1590003940	S.TRA RN1105(TE85L,F)	B	126.4/25
Q741	1590003940	S.TRA RN1105(TE85L,F)	B	79.4/9
Q742	1520000460	S.TRA 2SB1132 T100 R	B	83.6/8.2
Q980	1590003940	S.TRA RN1105(TE85L,F)	T	51.3/84.6
Q981	1590003940	S.TRA RN1105(TE85L,F)	T	51.5/13.8
Q982	1590003940	S.TRA RN1105(TE85L,F)	T	53.8/97.3
Q983	1590003940	S.TRA RN1105(TE85L,F)	T	51.2/56.9
Q984	1590003940	S.TRA RN1105(TE85L,F)	T	51.6/97.2
Q985	1590003940	S.TRA RN1105(TE85L,F)	T	51.3/27.9
Q986	1590003940	S.TRA RN1105(TE85L,F)	T	51.3/71.4
Q987	1590003940	S.TRA RN1105(TE85L,F)	T	52.5/41.6
Q988	1590003930	S.TRA UMD22N TR	T	58.2/90.2
D101	1750000301	S.DIO 1SS302(TE85R,F)	T	152.4/22.7
D102	1750000301	S.DIO 1SS302(TE85R,F)	T	152.4/19.8
D151	1750000581	S.DIO 1SV307(TPH3,F)	T	59.5/56.4
D152	1790001250	S.DIO MA2S111-(TX)	T	56.3/58.5
D301	1160000060	S.DIO DAN202U T106	T	105.1/80.8
D302	1160000060	S.DIO DAN202U T106	T	74.9/87.3
D401	1790001240	S.DIO MA2S728-(TX)	B	128/133.6
D402	1790001240	S.DIO MA2S728-(TX)	B	127.5/139.5
D403	1790001240	S.DIO MA2S728-(TX)	B	123.4/140.5
D404	1790001240	S.DIO MA2S728-(TX)	B	125.6/132.8
D406	1710001061	DIO L407CDB		
D407	1710001061	DIO L407CDB		
D408	1750000511	S.DIO UX9401F-STD/TR	B	97.7/136.4
D409	1750000511	S.DIO UX9401F-STD/TR	B	103.5/133
D410	1750000511	S.DIO UX9401F-STD/TR	B	104.7/130
D411	1790001250	S.DIO MA2S111-(TX)	B	94.2/129.2
D412	1160000070	S.DIO DAN202K T146	B	91.6/127
D451	1750000581	S.DIO 1SV307(TPH3,F)	B	85.5/116.3
D452	1750000581	S.DIO 1SV307(TPH3,F)	B	82.4/116
D453	1720000701	S.VAR 1SV305(TPL3,F)	T	75.5/117.3
D454	1720000701	S.VAR 1SV305(TPL3,F)	T	77.8/116.6
D455	1720000701	S.VAR 1SV305(TPL3,F)	B	75.6/99.1
D456	1720000701	S.VAR 1SV305(TPL3,F)	B	67.3/104.1
D461	1750000581	S.DIO 1SV307(TPH3,F)	B	65/93.5
D462	1750000581	S.DIO 1SV307(TPH3,F)	T	65.6/94.7
D501	1790000970	S.DIO MA729(TX)	B	113.7/123.4
D502	1790000970	S.DIO MA729(TX)	B	116.3/122.8
D503	1790000970	S.DIO MA729(TX)	B	114.5/129.4
D504	1790000970	S.DIO MA729(TX)	B	111/129.4
D506	1710001061	DIO L407CDB		
D507	1750000511	S.DIO UX9401F-STD/TR	B	92.1/117.4
D508	1750000511	S.DIO UX9401F-STD/TR	T	86.9/114.4
D509	1750000511	S.DIO UX9401F-STD/TR	T	81.9/120.3
D510	1710001061	DIO L407CDB		
D511	1750000581	S.DIO 1SV307(TPH3,F)	B	95.3/112.2
D551	1750000581	S.DIO 1SV307(TPH3,F)	T	74/116.7
D552	1750000581	S.DIO 1SV307(TPH3,F)	T	72.2/116.7
D553	1750000610	S.VAR MA2SV0500L 0	T	67.2/118.5
D554	1750000610	S.VAR MA2SV0500L 0	T	69.6/117.8
D555	1750000581	S.DIO 1SV307(TPH3,F)	T	66.9/116.7
D556	1720000590	S.VAR MA357(TX) 0	T	71.6/113.3
D557	1750000581	S.DIO 1SV307(TPH3,F)	T	68.1/104.9
D558	1720000590	S.VAR MA357(TX) 0	T	72.2/104.3
D559	1750000610	S.VAR MA2SV0500L 0	T	68.9/102.7
D560	1750000610	S.VAR MA2SV0500L 0	T	71.7/101.3
D701	1790000700	DIO DSA3A1		
D702	1790000700	DIO DSA3A1		
D703	1160000070	S.DIO DAN202K T146	B	126.5/21.5
D704	1790001240	S.DIO MA2S728-(TX)	B	87.9/113.9
D705	1160000070	S.DIO DAN202K T146	B	137.5/14.2
D706	1790001240	S.DIO MA2S728-(TX)	B	86/113
D801	1750000301	S.DIO 1SS302(TE85R,F)	B	42.7/41.8
D820	1750000301	S.DIO 1SS302(TE85R,F)	B	54.3/94.5
D840	1750000301	S.DIO 1SS302(TE85R,F)	B	43.3/99.8
D860	1750000301	S.DIO 1SS302(TE85R,F)	B	43/86
D880	1750000301	S.DIO 1SS302(TE85R,F)	B	43.3/71.6
D900	1750000301	S.DIO 1SS302(TE85R,F)	B	43.7/56.9
D920	1750000301	S.DIO 1SS302(TE85R,F)	B	42.9/28
D940	1750000301	S.DIO 1SS302(TE85R,F)	B	41.1/14.2
D961	1790000491	S.DIO HSM88ASTR-E	B	28.1/130.2
D962	1790000491	S.DIO HSM88ASTR-E	B	28.1/133.7
D964	1750000511	S.DIO UX9401F-STD/TR	B	40.1/43.9
D965	1750000511	S.DIO UX9401F-STD/TR	B	42.8/48

M.=Mounted side (T: Mounted on the Top side, B: Mounted on the Bottom side)
S.=Surface mount

[PA UNIT]

REF NO.	PARTS NO.	DESCRIPTION	M.	H/V LOCATION
L101	6200005051	S.COI NLV25T-330J	T	151.3/33.6
L102	6200008570	S.COI LQW2BHN6N8D03L	T	152.3/37.3
L103	6180000990	COI LAL 04NA 101K		
L104	6180000990	COI LAL 04NA 101K		
L105	6200003950	S.COI HF50ACC 322513-T	B	135.7/34.1
L107	6200002631	S.COI NLV25-FR10J	T	141/47.9
L108	6200003031	S.COI NLV32T-FR47J	B	138/41.7
L151	6200003941	S.COI NLV25T-5R6J	B	64.1/41
L152	6200005521	S.COI NLV25T-470J	B	64.8/38
L201	6140004580	S.COI LR-515	T	150.4/52.5
L203	6200010040	S.COI AS100340-10N	T	113.8/79.5
L204	6200010040	S.COI AS100340-10N	T	123.5/69.7
L301	6140003410	COI LR-383		
L302	2040000490	COI EXC-ELDR25C		
L303	6140003590	COI LR-400 (TR10X5X5 6H3)		
L304	6140004570	COI LR-507		
L305	6140004560	COI LR-506		
L404	6200010060	S.COI AS080647-56N	T	141/108.9
L407	6200010170	S.COI AS080447-33N	T	146.6/110.7
L408	2040000490	COI EXC-ELDR25C		
L409	2040000490	COI EXC-ELDR25C		
L410	6200010040	S.COI AS100340-10N	T	126.5/137.8
L411	6200010420	S.COI FHW1210HC 1R0JGT <JJE>	T	118.3/136.7
L412	6200010160	S.COI AS080440-22N	T	104.4/134.4
L413	6200010150	S.COI AS080340-15N	T	88.2/139.5
L414	6200010150	S.COI AS080340-15N	T	81/133.5
L415	6200012960	S.COI 0.45-1.4-4TLL 12.1N <COMO>	T	99.2/134
L416	6200013000	S.COI 0.25-1.9-13TL 135N <COMO>	T	93.8/132.1
L417	6200007790	S.COI LQW2BHN15J03L	B	98.3/131.1
L441	6200010040	S.COI AS100340-10N	T	133.4/137.8
L451	6200005621	S.COI ELJRE 4N7ZFA	B	81.5/120.1
L452	6200012660	S.COI 0.30-1.0-4TR 9.1N <COMO>	T	76.7/119.4
L453	6200007230	S.COI LQW2BHN15N03L	B	74/104
L454	6200007230	S.COI LQW2BHN15N03L	B	69.9/102.3
L501	6200010780	S.COI C2520C-1R0G-A	T	117.1/86.6
L502	6200010060	S.COI AS080647-56N	T	118.1/125
L504	6200010780	S.COI C2520C-1R0G-A	T	105.7/123.4
L505	6200010070	S.COI AS080747-68N	T	90.2/118.5
L506	6200010170	S.COI AS080447-33N	T	91.9/124.3
L507	6200012910	S.COI 0.35-1.6-8TL 45.5N <COMO>	T	84.7/118
L508	6200010050	S.COI AS080547-47N	T	81.8/127.7
L509	6200010780	S.COI C2520C-1R0G-A	T	93.2/113.1
L510	6200010050	S.COI AS080547-47N	T	75.5/127.5
L531	6110003980	COI LA-604		
L541	6200010070	S.COI AS080747-68N	T	128.5/129.8
L551	6200007700	S.COI LQW2BHN22N03L	T	76.1/120.8
L552	6200007720	S.COI LQW2BHN33N03L	T	70.8/121.2
L553	6200008090	S.COI LQW2BHN68N03L	T	65.1/121.6
L554	6200003640	S.COI MLF1608E 100K-T	T	64.9/114.8
L555	6200003711	S.COI NLV25T-2R7J	T	65.2/105.4
L556	6200003640	S.COI MLF1608E 100K-T	B	64.9/109.6
L557	6200007760	S.COI LQW2BHN82N03L	T	66.8/100.5
L558	6200007710	S.COI LQW2BHN27N03L	T	69.9/98.3
L560	6200002611	S.COI NLV25T-FR47J	T	62.9/97.7
L601	6200010040	S.COI AS100340-10N	T	69.2/127.5
L602	6200010160	S.COI AS080440-22N	T	65.7/132.8
L603	6200010150	S.COI AS080340-15N	T	60.8/133.5
L705	6200003550	S.COI MLF1608A 4R7K-T	B	68.2/10.3
L706	6200011300	S.COI EXCML16A270U	T	91/6.9
L707	6200011300	S.COI EXCML16A270U	T	91/5.6
L801	6200011410	S.COI C2520C-82NG-A	T	55.8/55.5
L802	6200010650	S.COI C2520C-1R12G-A (0.12U)	T	58.5/52.1
L803	6200007420	S.COI ELJFC 101K-F	B	50.4/39.8
L820	6200006430	S.COI ELJFC 180K-F	B	52.8/97.3
L821	6140002020	COI LR-229 (T50-10)		
L822	6140003540	COI LR-396		
L823	6200006430	S.COI ELJFC 180K-F	B	2.7/106.8
L840	6200007420	S.COI ELJFC 101K-F	B	49.2/98.5
L841	6140001820	COI LR-218 (T50-10)		
L842	6140001800	COI LR-216 (T50-2)		
L843	6140001800	COI LR-216 (T50-2)		
L844	6200007420	S.COI ELJFC 101K-F	B	2.6/90.7
L860	6200004440	S.COI ELJFC 4R7M-F	B	50.3/83.8
L861	6110003550	COI LA-547 (LA-214A)		
L862	6110003570	COI LA-550		
L863	6110003540	COI LA-548 (LA-215A)		
L864	6200004440	S.COI ELJFC 4R7M-F	B	2.8/74.5
L880	6200007420	S.COI ELJFC 101K-F	B	50.3/69.1
L881	6140002570	COI LR-294 (T50-2)		
L882	6140002580	COI LR-295 (T50-2)		
L883	6200007420	S.COI ELJFC 101K-F	B	2.6/58.4
L900	6200008600	S.COI ELJFC 560K-F	B	50/54.6
L901	6140002560	COI LR-293 (T50-10)		
L902	6140002560	COI LR-293 (T50-10)		
L903	6140002560	COI LR-293 (T50-10)		
L904	6200008600	S.COI ELJFC 560K-F	B	2.6/42.3
L920	6200007420	S.COI ELJFC 101K-F	B	50.4/25.4
L921	6140001780	COI LR-214 (T50-2)		
L922	6140001780	COI LR-214 (T50-2)		
L923	6200007420	S.COI ELJFC 101K-F	B	2.6/26.1
L940	6200007390	S.COI ELJFC 120K-F	B	47.3/9.9
L941	6140003450	COI LR-387 (T50-10)		
L942	6140003460	COI LR-388 (T50-10)		
L943	6200007420	S.COI ELJFC 101K-F	B	41.1/11.1
L944	6200007390	S.COI ELJFC 120K-F	B	9/10.5
L960	6200007420	S.COI ELJFC 101K-F	B	45.3/130.6
L961	6140003490	COI LR-391 (TR10X5X5 3A6)		
L980	6200007420	S.COI ELJFC 101K-F	B	30.7/8
L981	6200007420	S.COI ELJFC 101K-F	T	51.7/9

[PA UNIT]

REF NO.	PARTS NO.	DESCRIPTION	M.	H/V LOCATION
L982	6200007420	S.COI ELJFC 101K-F	T	48.3/2.3
R101	7030003370	S.RES ERJ3GEYJ 271 V (270)	B	150.9/21
R102	7030003230	S.RES ERJ3GEYJ 180 V (18)	B	150.9/22.5
R103	7030003370	S.RES ERJ3GEYJ 271 V (270)	B	151.9/25.2
R104	7030003300	S.RES ERJ3GEYJ 680 V (68)	B	150.8/27.7
R105	7030003420	S.RES ERJ3GEYJ 681 V (680)	T	152.7/29.8
R106	7030003480	S.RES ERJ3GEYJ 222 V (2.2K)	B	147.8/29.7
R107	7030003530	S.RES ERJ3GEYJ 562 V (5.6K)	B	147.8/28.3
R108	7030003400	S.RES ERJ3GEYJ 471 V (470)	T	151.4/31.7
R109	7030008190	S.RES ERJ12YJ330U (33)	B	145.5/32.7
R110	7030000230	S.RES MCR10EZJH 56 (560)	T	149.4/39.8
R111	7030003410	S.RES ERJ3GEYJ 561 V (560)	B	143.8/42.1
R112	7030003510	S.RES ERJ3GEYJ 392 V (3.9K)	B	146.1/37.5
R113	7030003540	S.RES ERJ3GEYJ 682 V (6.8K)	B	146.1/35.7
R116	7030000340	S.RES MCR10EZJH 470 (471)	B	141.3/40.8
R117	7030003860	S.RES ERJ3GE JPW V	T	146.7/47.7
R151	7030003380	S.RES ERJ3GEYJ 331 V (330)	B	61.6/87.8
R152	7030003440	S.RES ERJ3GEYJ 102 V (1K)	B	61.7/60.1
R153	7030003520	S.RES ERJ3GEYJ 472 V (4.7K)	T	59.2/57.9
R201	7030003320	S.RES ERJ3GEYJ 101 V (100)	B	123/49.9
R202	7030003520	S.RES ERJ3GEYJ 472 V (4.7K)	B	136/49.8
R204	7030003440	S.RES ERJ3GEYJ 102 V (1K)	B	138/52.8
R205	7030010420	S.RES ERJ1TYJ 560U (56)	B	145/51.5
R301	7030009300	S.RES ERJ1WYOR00U	B	92.2/84.4
R302	7030010520	S.RES ERJ1TYJ 101U (100)	T	89.4/86.1
R303	7030009300	S.RES ERJ1WYOR00U	B	85.4/84.4
R304	7030003320	S.RES ERJ3GEYJ 101 V (100)	T	107.1/79.8
R305	7030010410	S.RES ERJ1TYJ 220U (22)	T	100.2/84.1
R306	7030003320	S.RES ERJ3GEYJ 101 V (100)	B	71.2/83.3
R307	7030010410	S.RES ERJ1TYJ 220U (22)	T	77.5/84.1
R308	7030003480	S.RES ERJ3GEYJ 222 V (2.2K)	B	99/84.9
R309	7030003480	S.RES ERJ3GEYJ 222 V (2.2K)	B	78.7/84.9
R310	7030007630	S.RES MCR100JZH 0.68 (R68)	B	100.1/82.2
R311	7030007630	S.RES MCR100JZH 0.68 (R68)	B	78.3/82.1
R312	7030011250	S.RES ERJ1TY 390U (39)	T	100.9/77.7
R313	7030010540	S.RES ERJ1TYJ 330U (33)	T	97.2/77.7
R314	7030010540	S.RES ERJ1TYJ 330U (33)	T	81.6/77.7
R315	7030011250	S.RES ERJ1TY 390U (39)	T	77.9/77.7
R317	7030010950	S.RES ERJ1TYJ 100U (10)	B	104/20.6
R318	7030010950	S.RES ERJ1TYJ 100U (10)	B	99.6/20.6
R319	7030010660	S.RES ERJ1TYJ 6R8U (6.8)	B	89.4/54.5
R402	7030003320	S.RES ERJ3GEYJ 101 V (100)	B	151.7/73.1
R403	7030003520	S.RES ERJ3GEYJ 472 V (4.7K)	T	151.8/71.2
R404	7030000260	S.RES MCR10EZJH 100 (101)	T	149.4/76
R405	7030003540	S.RES ERJ3GEYJ 682 V (6.8K)	B	126.7/137.5
R406	7030003860	S.RES ERJ3GE JPW V	B	128.4/136.1
R407	7030003440	S.RES ERJ3GEYJ 102 V (1K)	B	129.7/133.6
R408	7030003860	S.RES ERJ3GE JPW V	B	124.1/137.6
R409	7030003440	S.RES ERJ3GEYJ 102 V (1K)	B	127/130.4
R410	7030003440	S.RES ERJ3GEYJ 102 V (1K)	B	131.6/133
R411	7030003540	S.RES ERJ3GEYJ 682 V (6.8K)	B	125.1/135.5
R412	7030003500	S.RES ERJ3GEYJ 332 V (3.3K)	B	131.1/129.7
R413	7030007160	S.RES ERJ12YJ3R3U (3.3)	B	123.5/125.1
R415	7030008350	S.RES ERJ12YJ390U	B	86.7/136.4
R416	7030000140	S.RES MCR10EZJH 10 (100)	B	93.8/130.7
R417	7030000140	S.RES MCR10EZJH 10 (100)	B	95.5/132.5
R418	7030000010	S.RES MCR10EZJH JPW (000)	B	99.3/133.9
R451	7030003470	S.RES ERJ3GEYJ 182 V (1.8K)	B	81.5/121.7
R452	7030004040	S.RES ERJ3GEYJ 4R7 V (4.7)	B	85.5/119.3
R453	7030003260	S.RES ERJ3GEYJ 330 V (33)	B	81.6/118.4
R454	7030003860	S.RES ERJ3GE JPW V	B	77.3/116
R455	7030003640	S.RES ERJ3GEYJ 473 V (47K)	B	73.2/117.5
R456	7030003700	S.RES ERJ3GEYJ 154 V (150K)	B	72/114.4
R457	7030003750	S.RES ERJ3GEYJ 394 V (390K)	B	71.2/111.9
R458	7030003710	S.RES ERJ3GEYJ 184 V (180K)	B	73.8/112.4
R459	7030003740	S.RES ERJ3GEYJ 334 V (330K)	B	69.6/111.3
R460	7030003740	S.RES ERJ3GEYJ 334 V (330K)	B	76.6/112.1
R461	7030003270	S.RES ERJ3GEYJ 390 V (39)	B	77.7/103.3
R462	7030003680	S.RES ERJ3GEYJ 104 V (100K)	B	72.9/99.6
R463	7030003520	S.RES ERJ3GEYJ 472 V (4.7K)	B	74.4/102.4
R464	7030003210	S.RES ERJ3GEYJ 120 V (12)	B	74.1/105.7
R465	7030003680	S.RES ERJ3GEYJ 104 V (100K)	B	66.5/101.7
R466	7030003860	S.RES ERJ3GE JPW V	B	62.1/100.2
R467	7030003640	S.RES ERJ3GEYJ 473 V (47K)	B	75.1/117.2
R468	7030008240	S.RES ERJ12YOR00U	B	89.1/121.9
R470	7030003320	S.RES ERJ3GEYJ 101 V (100)	B	67.7/98.8
R471	7030003270	S.RES ERJ3GEYJ 390 V (39)	B	69.6/98.3
R472	7030003340	S.RES ERJ3GEYJ 151 V (150)	B	69.6/99.5
R473	7030003340	S.RES ERJ3GEYJ 151 V (150)	B	69.6/100.7
R474	7030003340	S.RES ERJ3GEYJ 151 V (150)	B	63.5/96.9
R475	7030003340	S.RES ERJ3GEYJ 151 V (150)	B	64.9/96.9
R476	7030003270	S.RES ERJ3GEYJ 390 V (39)	B	64.8/95.1
R477	7030003360	S.RES ERJ3GEYJ 221 V (220)	B	61.8/97.6
R502	7030003320	S.RES ERJ3GEYJ 101 V (100)	T	112.1/87.9
R503	7030003520	S.RES ERJ3GEYJ 472 V (4.7K)	T	112.6/86
R504	7030000260	S.RES MCR10EZJH 100 (101)	T	114.2/86.2
R505	7030003540	S.RES ERJ3GEYJ 682 V (6.8K)	B	119.9/124.8
R507	7030003440	S.RES ERJ3GEYJ 102 V (1K)	B	110.

[PA UNIT]

REF NO.	PARTS NO.	DESCRIPTION	M.	H/V LOCATION
R519	7030000010	S.RES MCR10EZHZ JPW (000)	B	111.1/119.1
R551	7030003470	S.RES ERJ3GEYJ 182 V (1.8K)	T	78.2/117.8
R552	7030004040	S.RES ERJ3GEYJ 4R7 V (4.7)	T	76.7/119.1
R553	7030003260	S.RES ERJ3GEYJ 330 V (33)	T	73/118.9
R554	7030003680	S.RES ERJ3GEYJ 104 V (100K)	T	66.8/120.4
R555	7030003440	S.RES ERJ3GEYJ 102 V (1K)	T	68.1/114.7
R556	7030003680	S.RES ERJ3GEYJ 104 V (100K)	T	69.9/116.6
R557	7030003740	S.RES ERJ3GEYJ 334 V (330K)	T	65.7/112.9
R558	7030003710	S.RES ERJ3GEYJ 184 V (180K)	T	70.5/111.2
R559	7030003720	S.RES ERJ3GEYJ 224 V (220K)	T	65.7/111.7
R560	7030003720	S.RES ERJ3GEYJ 224 V (220K)	T	65.6/110.5
R561	7030003740	S.RES ERJ3GEYJ 334 V (330K)	T	68.3/112.4
R562	7030003270	S.RES ERJ3GEYJ 390 V (39)	T	70.1/106.6
R563	7030003420	S.RES ERJ3GEYJ 681 V (680)	T	65.4/107.3
R564	7030003210	S.RES ERJ3GEYJ 120 V (12)	T	63.5/103
R565	7030003440	S.RES ERJ3GEYJ 102 V (1K)	B	65.6/106.3
R567	7030003680	S.RES ERJ3GEYJ 104 V (100K)	T	70.1/104
R568	7030003680	S.RES ERJ3GEYJ 104 V (100K)	T	69.7/100.7
R570	7030003380	S.RES ERJ3GEYJ 331 V (330)	T	62.8/100.3
R575	7030003520	S.RES ERJ3GEYJ 472 V (4.7K)	T	68.4/100.7
R576	7030003540	S.RES ERJ3GEYJ 682 V (6.8K)	T	71.8/100
R577	7030003520	S.RES ERJ3GEYJ 472 V (4.7K)	T	68/120.4
R578	7030003540	S.RES ERJ3GEYJ 682 V (6.8K)	T	69.9/119
R701	7030003500	S.RES ERJ3GEYJ 332 V (3.3K)	B	82.2/16.9
R702	7030003500	S.RES ERJ3GEYJ 332 V (3.3K)	B	83/14.5
R703	7030003500	S.RES ERJ3GEYJ 332 V (3.3K)	B	80.6/16.9
R704	7030003500	S.RES ERJ3GEYJ 332 V (3.3K)	B	79.7/14.5
R705	7030009300	S.RES ERJ1WYOR00U	B	134.6/23.8
R721	7030011240	S.RES LRF3W-LF-01-R020F	B	83/22.3
R722	7030011240	S.RES LRF3W-LF-01-R020F	B	83/29.6
R723	7030004040	S.RES ERJ3GEYJ 4R7 V (4.7)	B	140.5/14.7
R733	7030009591	S.RES ERA3YED 472V (4.7K)	B	138.6/10.4
R734	7510001470	S.THE NTCG20 4AG 473JT	T	111.9/58.2
R735	7030009591	S.RES ERA3YED 472V (4.7K)	B	140.2/12.5
R736	7510001470	S.THE NTCG20 4AG 473JT	T	153.3/77.1
R742	7030003640	S.RES ERJ3GEYJ 473 V (47K)	B	83.4/11.5
R743	7030003440	S.RES ERJ3GEYJ 102 V (1K)	B	80.2/10.9
R744	7030003860	S.RES ERJ3GE JPW V	T	67.8/9.6
R749	7030003860	S.RES ERJ3GE JPW V	B	65/5.2
R750	7030003860	S.RES ERJ3GE JPW V	B	66.6/5.2
R773	7030003860	S.RES ERJ3GE JPW V	T	103.4/9.5
R960	7030003860	S.RES ERJ3GE JPW V	B	43.2/125.7
R961	7030003380	S.RES ERJ3GEYJ 331 V (330)	B	42/138.3
R962	7030003440	S.RES ERJ3GEYJ 102 V (1K)	B	37.4/137.8
R963	7030003440	S.RES ERJ3GEYJ 102 V (1K)	B	40.3/126.3
R964	7030003860	S.RES ERJ3GE JPW V	B	24.8/131.2
R965	7030003640	S.RES ERJ3GEYJ 473 V (47K)	B	32.6/130.5
R966	7030008190	S.RES ERJ12YJ330U (33)	B	11.1/129.6
R967	7030003640	S.RES ERJ3GEYJ 473 V (47K)	B	34.2/130.5
R968	7030003860	S.RES ERJ3GE JPW V	B	24.8/132.8
R969	7030003600	S.RES ERJ3GEYJ 223 V (22K)	B	32.6/133.6
R970	7030003680	S.RES ERJ3GEYJ 104 V (100K)	B	34.2/133.6
R971	7540000130	ABS 2P-50A-301		
R972	7030003620	S.RES ERJ3GEYJ 333 V (33K)	B	17.4/140.1
R973	7030003620	S.RES ERJ3GEYJ 333 V (33K)	B	18.9/138.5
R974	7030003620	S.RES ERJ3GEYJ 333 V (33K)	B	19.4/136.6
R994	7030003560	S.RES ERJ3GEYJ 103 V (10K)	B	22.4/6.8
R995	7030003560	S.RES ERJ3GEYJ 103 V (10K)	B	22.4/6.8
R996	7030003560	S.RES ERJ3GEYJ 103 V (10K)	B	21.6/5.4
R997	7030003560	S.RES ERJ3GEYJ 103 V (10K)	B	21.6/8.2
R998	7030003320	S.RES ERJ3GEYJ 101 V (100)	T	54.1/4.4
R999	7030003320	S.RES ERJ3GEYJ 101 V (100)	T	54.5/3.1
R1000	7030003320	S.RES ERJ3GEYJ 101 V (100)	T	51.2/3.5
R1001	7030003320	S.RES ERJ3GEYJ 101 V (100)	T	49.3/4.9
R1002	7030000280	S.RES MCR10EZHZ 150 (151)	T	48/9.7
R1003	7030000290	S.RES MCR10EZHZ 180 (181)	T	47.5/7.9
C101	4030011600	S.CER C1608 JB 1E 104K-T	T	151.9/25.1
C102	4030011600	S.CER C1608 JB 1E 104K-T	B	150.8/29.3
C103	4030011340	S.CER C1608 CH 1H 471J-T	T	152.7/27.2
C104	4030011600	S.CER C1608 JB 1E 104K-T	T	147.8/32.2
C105	4510004591	ELE 16 ME 470 HC		
C106	4030011600	S.CER C1608 JB 1E 104K-T	B	142.7/29.2
C107	4030011600	S.CER C1608 JB 1E 104K-T	T	151.6/39.7
C108	4030011600	S.CER C1608 JB 1E 104K-T	T	149.2/36.5
C109	4030007130	S.CER C1608 CH 1H 101J-T	B	146.6/42.1
C112	4030011600	S.CER C1608 JB 1E 104K-T	B	139.2/35.1
C113	4030011600	S.CER C1608 JB 1E 104K-T	T	144.6/44.4
C114	4030011600	S.CER C1608 JB 1E 104K-T	B	134.1/37
C116	4030007060	S.CER C1608 CH 1H 270J-T	T	144.6/45.8
C118	4030007130	S.CER C1608 CH 1H 101J-T	T	143.5/48.5
C119	4030007130	S.CER C1608 CH 1H 101J-T	T	144/50.4
C120	4030007020	S.CER C1608 CH 1H 120J-T	T	143.5/47.2
C122	4510008500	S.ELE EEE1CA101WP	T	121.5/11.2
C151	4030011600	S.CER C1608 JB 1E 104K-T	T	59.2/54.8
C152	4030006880	S.CER C1608 JB 1H 472K-T	B	61.6/36.2
C153	4030011600	S.CER C1608 JB 1E 104K-T	B	63.1/56
C154	4030006860	S.CER C1608 JB 1H 102K-T	B	63.1/54.7
C201	4030006860	S.CER C1608 JB 1H 102K-T	T	145.6/53
C202	4030006860	S.CER C1608 JB 1H 102K-T	T	143/53
C204	4030011600	S.CER C1608 JB 1E 104K-T	B	139.3/48.4
C205	4030006860	S.CER C1608 JB 1H 102K-T	B	123.3/48.6
C206	4030017810	S.CER C1608 CH 1H 102J-T	B	133.5/50.6
C207	4030017810	S.CER C1608 CH 1H 102J-T	B	139.3/49.7
C208	4030011600	S.CER C1608 JB 1E 104K-T	B	132/50.6
C209	4030007170	S.CER C1608 CH 1H 221J-T	B	139.3/51
C214	4030018940	S.CER GRM31A7U2J331JW31D	T	116.3/76.1
C215	4030018930	S.CER GRM31A7U2J221JW31D	T	122.2/73.9

[PA UNIT]

REF NO.	PARTS NO.	DESCRIPTION	M.	H/V LOCATION
C217	4030011600	S.CER C1608 JB 1E 104K-T	T	144.3/53
C218	4030018930	S.CER GRM31A7U2J221JW31D	T	101/88.5
C219	4030018930	S.CER GRM31A7U2J221JW31D	B	82.4/99.7
C251	4030011180	S.CER GRM31M2C2H220JV01L (GRM42-6 CH)	B	134.9/66
C252	4030011180	S.CER GRM31M2C2H220JV01L (GRM42-6 CH)	B	142.2/70.6
C253	4030011080	S.CER GRM31M2C2H6R0DV01L (GRM42-6 CH)	B	145.5/79
C254	4030011160	S.CER GRM31M2C2H150JV01L (GRM42-6 CH)	B	127.7/65.3
C261	4030012480	S.CER GRM31M2C2H121JV01L (GRM42-6 CH)	B	131.7/75.1
C262	4030018940	S.CER GRM31A7U2J331JW31D	B	126/80.1
C263	4030018770	S.CER C3216 CH 2J 102J-T	B	122.1/80.7
C266	4030018950	S.CER GRM31A7U2J681JW31D	B	119.7/80.2
C267	4030018930	S.CER GRM31A7U2J221JW31D	B	124/85.3
C301	4030001100	S.CER GRM216B11H102KA01D (GRM40 B)	B	91.7/100.6
C302	4030001020	S.CER GRM216C21H121JA01D (GRM40 CH)	B	93.8/100.6
C303	4030011600	S.CER C1608 JB 1E 104K-T	B	110.8/85.5
C304	4030017320	S.CER GRM21BB11H104KA01L (GRM40-034)	B	94.8/97.6
C305	4510004591	ELE 16 ME 470 HC		
C306	4030004720	S.CER C2012 JB 1H 102K-T	[EUR] B	83.6/39.8
	4030004720	S.CER C2012 JB 1H 102K-T	[FRA]	
	4030004720	S.CER C2012 JB 1H 102K-T	[ESP]	
	4030004720	S.CER C2012 JB 1H 102K-T	[USA]	
	4030004720	S.CER C2012 JB 1H 102K-T	[EXP]	
	4030004720	S.CER C2012 JB 1H 102K-T	[ITR]	
	4030004720	S.CER C2012 JB 1H 102K-T	[UK]	
	4030004720	S.CER C2012 JB 1H 102K-T	[KOR]	
	4030006860	S.CER C1608 JB 1H 102K-T	[AUS]	
	4030004720	S.CER C2012 JB 1H 102K-T	[CHN]	
	4030004720	S.CER C2012 JB 1H 102K-T	[EUR]	
C307	4030004720	S.CER C2012 JB 1H 102K-T	B	100.6/39.8
	4030004720	S.CER C2012 JB 1H 102K-T	[FRA]	
	4030004720	S.CER C2012 JB 1H 102K-T	[ESP]	
	4030004720	S.CER C2012 JB 1H 102K-T	[USA]	
	4030004720	S.CER C2012 JB 1H 102K-T	[EXP]	
	4030004720	S.CER C2012 JB 1H 102K-T	[ITR]	
	4030004720	S.CER C2012 JB 1H 102K-T	[UK]	
	4030004720	S.CER C2012 JB 1H 102K-T	[KOR]	
	4030006860	S.CER C1608 JB 1H 102K-T	[AUS]	
	4030004720	S.CER C2012 JB 1H 102K-T	[CHN]	
C308	4030004720	S.CER C2012 JB 1H 102K-T	B	91.9/10.9
	4030004720	S.CER C2012 JB 1H 102K-T	[FRA]	
	4030004720	S.CER C2012 JB 1H 102K-T	[ESP]	
	4030004720	S.CER C2012 JB 1H 102K-T	[USA]	
	4030004720	S.CER C2012 JB 1H 102K-T	[EXP]	
	4030004720	S.CER C2012 JB 1H 102K-T	[ITR]	
	4030004720	S.CER C2012 JB 1H 102K-T	[UK]	
	4030004720	S.CER C2012 JB 1H 102K-T	[KOR]	
	4030006860	S.CER C1608 JB 1H 102K-T	[AUS]	
	4030004720	S.CER C2012 JB 1H 102K-T	[CHN]	
C309	4030011600	S.CER C1608 JB 1E 104K-T	T	105.8/78.3
C311	4030018750	S.CER C3225 CH 2J 682K-T	B	92.7/78.5
C312	4030018750	S.CER C3225 CH 2J 682K-T	B	84.9/78.5
C313	4030011600	S.CER C1608 JB 1E 104K-T	T	76.8/87.8
C314	4030018750	S.CER C3225 CH 2J 682K-T	B	96.9/77.6
C315	4030018750	S.CER C3225 CH 2J 682K-T	B	80.6/77.6
C319	4030011730	S.CER GRM31M2C2H101JV01L (GRM42-6 CH)	B	110/48.8
C320	4030011730	S.CER GRM31M2C2H101JV01L (GRM42-6 CH)	B	71.1/48.9
C323	4030003810	S.MIC UC342H 1200J-T	B	91.4/46.4
C324	4320001050	S.MIC UC342H 3900J-T	T	94.4/40.2
C325	4320001070	S.MIC UC342H 3300J-T	B	94.4/40.7
C327	4030011790	S.CER GRM55RF52A684ZD01L (GRM44-1)	T	65.9/46.3
C331	4030011600	S.CER C1608 JB 1E 104K-T	T	108.3/78.3
C332	4030011600	S.CER C1608 JB 1E 104K-T	B	69.5/81.4
C333	4030018940	S.CER GRM31A7U2J331JW31D	B	88.4/101.8
C340	4030006860	S.CER C1608 JB 1H 102K-T	B	82.3/107.3
C341	4030006860	S.CER C1608 JB 1H 102K-T	B	92.4/107.4
C342	4030006860	S.CER C1608 JB 1H 102K-T	B	87.1/91.6
C350	4030004720	S.CER C2012 JB 1H 102K-T	[EUR] B	103.4/39.8
	4030004720	S.CER C2012 JB 1H 102K-T	[FRA]	
	4030004720	S.CER C2012 JB 1H 102K-T	[ESP]	
	4030004720	S.CER C2012 JB 1H 102K-T	[USA]	
	4030004720	S.CER C2012 JB 1H 102K-T	[EXP]	
	4030004720	S.CER C2012 JB 1H 102K-T	[ITR]	
	4030004720	S.CER C2012 JB 1H 102K-T	[UK]	
	4030004720	S.CER C2012 JB 1H 102K-T	[KOR]	
	4030004720	S.CER C2012 JB 1H 102K-T	[CHN]	
C351	4030004720	S.CER C2012 JB 1H 102K-T	B	106.1/39.8
	4030004720	S.CER C2012 JB 1H 102K-T	[FRA]	
	4030004720	S.CER C2012 JB 1H 102K-T	[ESP]	
	4030004720	S.CER C2012 JB 1H 102K-T	[USA]	
	4030004720	S.CER C2012 JB 1H 102K-T	[EXP]	
	4030004720	S.CER C2012 JB 1H 102K-T	[ITR]	
	4030004720	S.CER C2012 JB 1H 102K-T	[UK]	
	4030004720	S.CER C2012 JB 1H 102K-T	[KOR]	
	4030004720	S.CER C2012 JB 1H 102K-T	[CHN]	
C353	4030004720	S.CER C2012 JB 1H 102K-T	B	86.3/39.8
	4030004720	S.CER C2012 JB 1H 102K-T	[FRA]	
	4030004720	S.CER C2012 JB 1H 102K-T	[ESP]	
</				

[PA UNIT]

REF NO.	PARTS NO.	DESCRIPTION	M.	H/V LOCATION
C353	4030004720	S.CER C2012 JB 1H 102K-T [ITR]	B	86.3/39.8
	4030004720	S.CER C2012 JB 1H 102K-T [UK]		
C354	4030004720	S.CER C2012 JB 1H 102K-T [KOR]	B	89.1/39.8
	4030004720	S.CER C2012 JB 1H 102K-T [CHN]		
	4030004720	S.CER C2012 JB 1H 102K-T [EUR]		
	4030004720	S.CER C2012 JB 1H 102K-T [FRA]		
	4030004720	S.CER C2012 JB 1H 102K-T [ESP]		
	4030004720	S.CER C2012 JB 1H 102K-T [USA]		
	4030004720	S.CER C2012 JB 1H 102K-T [EXP]		
	4030004720	S.CER C2012 JB 1H 102K-T [ITR]		
	4030004720	S.CER C2012 JB 1H 102K-T [UK]		
	4030004720	S.CER C2012 JB 1H 102K-T [KOR]		
C356	4030004720	S.CER C2012 JB 1H 102K-T [CHN]	B	97.5/10.9
	4030004720	S.CER C2012 JB 1H 102K-T [EUR]		
	4030004720	S.CER C2012 JB 1H 102K-T [FRA]		
	4030004720	S.CER C2012 JB 1H 102K-T [ESP]		
	4030004720	S.CER C2012 JB 1H 102K-T [USA]		
	4030004720	S.CER C2012 JB 1H 102K-T [EXP]		
	4030004720	S.CER C2012 JB 1H 102K-T [ITR]		
	4030004720	S.CER C2012 JB 1H 102K-T [UK]		
	4030004720	S.CER C2012 JB 1H 102K-T [KOR]		
	4030004720	S.CER C2012 JB 1H 102K-T [CHN]		
C357	4030004720	S.CER C2012 JB 1H 102K-T [EUR]	B	94.7/10.9
	4030004720	S.CER C2012 JB 1H 102K-T [FRA]		
	4030004720	S.CER C2012 JB 1H 102K-T [ESP]		
	4030004720	S.CER C2012 JB 1H 102K-T [USA]		
	4030004720	S.CER C2012 JB 1H 102K-T [EXP]		
	4030004720	S.CER C2012 JB 1H 102K-T [ITR]		
	4030004720	S.CER C2012 JB 1H 102K-T [UK]		
	4030004720	S.CER C2012 JB 1H 102K-T [KOR]		
	4030004720	S.CER C2012 JB 1H 102K-T [CHN]		
	4030004720	S.CER C2012 JB 1H 102K-T [EUR]		
C358	4030006860	S.CER C1608 JB 1H 102K-T [FRA]	B	90/91.6
	4030006860	S.CER C1608 JB 1H 102K-T [ESP]		
	4030006860	S.CER C1608 JB 1H 102K-T [USA]		
	4030006860	S.CER C1608 JB 1H 102K-T [EXP]		
	4030006860	S.CER C1608 JB 1H 102K-T [ITR]		
	4030006860	S.CER C1608 JB 1H 102K-T [UK]		
	4030006860	S.CER C1608 JB 1H 102K-T [KOR]		
	4030006860	S.CER C1608 JB 1H 102K-T [CHN]		
	4030006860	S.CER C1608 JB 1H 102K-T [EUR]		
	4030006860	S.CER C1608 JB 1H 102K-T [FRA]		
C359	4030006860	S.CER C1608 JB 1H 102K-T [ESP]	B	94.9/107.4
	4030006860	S.CER C1608 JB 1H 102K-T [USA]		
	4030006860	S.CER C1608 JB 1H 102K-T [EXP]		
	4030006860	S.CER C1608 JB 1H 102K-T [ITR]		
	4030006860	S.CER C1608 JB 1H 102K-T [UK]		
	4030006860	S.CER C1608 JB 1H 102K-T [KOR]		
	4030006860	S.CER C1608 JB 1H 102K-T [CHN]		
	4030006860	S.CER C1608 JB 1H 102K-T [EUR]		
	4030006860	S.CER C1608 JB 1H 102K-T [FRA]		
	4030006860	S.CER C1608 JB 1H 102K-T [ESP]		
C360	4030006860	S.CER C1608 JB 1H 102K-T [USA]	B	85/107.3
	4030006860	S.CER C1608 JB 1H 102K-T [EXP]		
	4030006860	S.CER C1608 JB 1H 102K-T [ITR]		
	4030006860	S.CER C1608 JB 1H 102K-T [UK]		
	4030006860	S.CER C1608 JB 1H 102K-T [KOR]		
	4030006860	S.CER C1608 JB 1H 102K-T [CHN]		
	4030006860	S.CER C1608 JB 1H 102K-T [EUR]		
	4030006860	S.CER C1608 JB 1H 102K-T [FRA]		
	4030006860	S.CER C1608 JB 1H 102K-T [ESP]		
	4030006860	S.CER C1608 JB 1H 102K-T [USA]		
C403	4030006860	S.CER C1608 JB 1H 102K-T [ITR]	B	89.6/133.4
C404	4030006860	S.CER C1608 JB 1H 102K-T [UK]	B	151.7/71.4
C405	4030011740	S.CER GRM32N2C2H201JV01L (GRM42-2 CH)	T	145.3/105.7
C406	4030006860	S.CER C1608 JB 1H 102K-T [KOR]	B	132.4/129.7
C408	4030018040	S.CER ERF22X 6C2H 180J D01L	B	134.2/93
C409	4030018040	S.CER ERF22X 6C2H 180J D01L	B	145.4/93
C410	4030018260	S.CER ERF22X 6C2H 150J D01L	B	145.4/96.4
C411	4030018260	S.CER ERF22X 6C2H 150J D01L	B	134.2/96.4
C412	4030018770	S.CER C3216 CH 2J 102J-T	T	136/111.5
C413	4030018770	S.CER C3216 CH 2J 102J-T	T	139.8/102.7
C415	4030018410	S.CER ERF22X 6C2H 2R0C D01L	T	143.1/139.4
C416	4030006880	S.CER C1608 JB 1H 472K-T	T	103.1/96.7
C417	4030018040	S.CER ERF22X 6C2H 180J D01L	T	139.2/136.2
C418	4030011120	S.CER GRM31M2C2H100JV01L (GRM42-6 CH)	B	134.1/134.2
C419	4030011020	S.CER GRM31M4C2H1R0CY21L (GRM42-6 CK)	B	132.6/138.2
C420	4030011080	S.CER GRM31M2C2H6R0DV01L (GRM42-6 CH)	B	129.2/139.5
C421	4030011020	S.CER GRM31M4C2H1R0CY21L (GRM42-6 CK)	B	120.6/136.8
C422	4030011120	S.CER GRM31M2C2H100JV01L (GRM42-6 CH)	B	121.7/141.1
C423	4030007090	S.CER C1608 CH 1H 470J-T	B	127.8/131.7
C424	4030011090	S.CER GRM31M2C2H7R0DV01L (GRM42-6 CH)	B	119/140.3
C425	4030011180	S.CER GRM31M2C2H220JV01L (GRM42-6 CH)	T	121.6/137.4
C426	4030006860	S.CER C1608 JB 1H 102K-T	B	106.7/133.9
C427	4030011020	S.CER GRM31M4C2H1R0CY21L (GRM42-6 CK) [EUR]	B	102.6/139.6
	4030011020	S.CER GRM31M4C2H1R0CY21L (GRM42-6 CK) [FRA]		
	4030011020	S.CER GRM31M4C2H1R0CY21L (GRM42-6 CK) [ESP]		
	4030011020	S.CER GRM31M4C2H1R0CY21L (GRM42-6 CK) [USA]		
	4030011020	S.CER GRM31M4C2H1R0CY21L (GRM42-6 CK) [EXP]		

[PA UNIT]

REF NO.	PARTS NO.	DESCRIPTION	M.	H/V LOCATION
C427	4030011020	S.CER GRM31M4C2H1R0CY21L (GRM42-6 CK) [ITR]	B	102.6/139.6
	4030011040	S.CER GRM31M4C2H2R0CY21L (GRM42-6 CK) [UK]		
	4030011020	S.CER GRM31M4C2H1R0CY21L (GRM42-6 CK) [KOR]		
	4030011020	S.CER GRM31M4C2H1R0CY21L (GRM42-6 CK) [AUS]		
	4030011020	S.CER GRM31M4C2H1R0CY21L (GRM42-6 CK) [CHN]		
C428	4030011090	S.CER GRM31M2C2H7R0DV01L (GRM42-6 CH)	T	97/138.1
C429	4030017940	S.CER ERF22X 6C2H 680J D01L	T	92.3/136.9
C430	4030019410	S.CER GRM31A7U2J471JW31D	B	94.2/138
C431	4030011070	S.CER GRM31M2C2H5R0CY21L (GRM42-6 CH)	T	86.9/133.8
C432	4030004820	S.CER C2012 CH 1H 050C-T	B	99.2/139.3
C433	4030011090	S.CER GRM31M2C2H7R0DV01L (GRM42-6 CH)	T	76.1/132.2
C434	4030006860	S.CER C1608 JB 1H 102K-T	B	89.9/124.9
C435	4030006860	S.CER C1608 JB 1H 102K-T	B	97.2/127.7
C436	4030006860	S.CER C1608 JB 1H 102K-T	T	98.4/130.9
C438	4030006850	S.CER C1608 JB 1H 471K-T	B	90.8/134
C439	4030006860	S.CER C1608 JB 1H 102K-T	B	92.8/133.1
C440	4030004710	S.CER C2012 JB 1H 471K-T	B	103.5/135.5
C441	4030011090	S.CER GRM31M2C2H7R0DV01L (GRM42-6 CH)	T	137.6/140.4
C443	4030011020	S.CER GRM31M4C2H1R0CY21L (GRM42-6 CK)	B	122.1/131
C444	4030006860	S.CER C1608 JB 1H 102K-T	B	59.3/117.9
C452	4030007020	S.CER C1608 CH 1H 120J-T	B	87.3/119.3
C453	4030006860	S.CER C1608 JB 1H 102K-T	T	63.9/117.3
C456	4030009350	S.CER C1608 CH 1H 3R5B-T	B	78.2/118.4
C458	4030006860	S.CER C1608 JB 1H 102K-T	T	73.8/113.1
C461	4030011600	S.CER C1608 JB 1E 104K-T	B	68.8/113.3
C462	4030011600	S.CER C1608 JB 1E 104K-T	B	77.1/110.8
C463	4030006860	S.CER C1608 JB 1H 102K-T	B	79.1/109.6
C464	4030011600	S.CER C1608 JB 1E 104K-T	B	77.7/105.9
C465	4030011600	S.CER C1608 JB 1E 104K-T	B	67.7/108.9
C466	4030006860	S.CER C1608 JB 1H 102K-T	B	77.7/104.6
C467	4030006860	S.CER C1608 JB 1H 102K-T	B	67.7/107.6
C468	4030007020	S.CER C1608 CH 1H 120J-T	B	73.7/101.1
C470	4030011600	S.CER C1608 JB 1E 104K-T	B	77.7/101.7
C471	4030006860	S.CER C1608 JB 1H 102K-T	B	77.7/100.4
C472	4030009500	S.CER C1608 CH 1H 0R5B-T	B	69.7/105.2
C473	4030007040	S.CER C1608 CH 1H 180J-T	B	69.7/104
C474	4030009530	S.CER C1608 CH 1H 030B-T	B	67.7/101.7
C475	4030006860	S.CER C1608 JB 1H 102K-T	B	66.5/98.8
C476	4030006860	S.CER C1608 JB 1H 102K-T	B	68/111.3
C477	4030006860	S.CER C1608 JB 1H 102K-T	B	79.1/121.9
C478	4030006860	S.CER C1608 JB 1H 102K-T	B	57.7/120.5
C479	4030006860	S.CER C1608 JB 1H 102K-T	B	65.9/121.8
C480	4030007090	S.CER C1608 CH 1H 470J-T	B	63.4/100.8
C481	4030006860	S.CER C1608 JB 1H 102K-T	B	69.6/96.3
C482	4030006860	S.CER C1608 JB 1H 102K-T	B	67.9/94.5
C483	4030006860	S.CER C1608 JB 1H 102K-T	B	64.2/98.8
C484	4030007010	S.CER C1608 CH 1H 100D-T	B	74.3/108.1
C485	4030017810	S.CER C1608 CH 1H 102J-T	B	68.8/107.2
C501	4030006860	S.CER C1608 JB 1H 102K-T	T	109.3/87.9
C503	4030011070	S.CER GRM31M2C2H5R0CY21L (GRM42-6 CH)	T	119.4/130.3
C504	4030017960	S.CER ERF22X 6C2H 330J D01L	T	111.8/122.1
C505	4030011040	S.CER GRM31M4C2H2R0CY21L (GRM42-6 CK)	B	114.4/125.4
C506	4030011120	S.CER GRM31M2C2H100JV01L (GRM42-6 CH)	B	118.2/125.6
C507	4030011040	S.CER GRM31M4C2H2R0CY21L (GRM42-6 CK)	B	113.8/131.5
C508	4030011070	S.CER GRM31M2C2H5R0CY21L (GRM42-6 CH)	B	110.4/132.8
C509	4030007150	S.CER C1608 CH 1H 151J-T	B	110.2/121.5
C511	4030018770	S.CER C3216 CH 2J 102J-T	T	109.6/125.4
C513	4030006860	S.CER C1608 JB 1H 102K-T	B	97.1/117.6
C514	4030011170	S.CER GRM31M2C2H180JV01L (GRM42-6 CH)	T	98.4/118.1
C515	4030018770	S.CER C3216 CH 2J 102J-T	T	96.9/120.4
C516	4030011100	S.CER GRM31M2C2H8R0DV01L (GRM42-6 CH)	T	88.2/124.1
C517	4030004880	S.CER C2012 CH 1H 120J-T	B	92.5/115.1
C518	4030018770	S.CER C3216 CH 2J 102J-T	B	94.1/121.4
C519	4030011190	S.CER GRM31M2C2H270JV01L (GRM42-6 CH)	T	86.1/124.1
C520	4030004870	S.CER C2012 CH 1H 100D-T	B	93.4/112.4
C521	4030011290	S.CER GRM31M2C2H240JV01L (GRM42-6 CH)	T	81.2/123.9
C522	4030006850	S.CER C1608 JB 1H 471K-T	T	96.3/107.7
C523	4030006860	S.CER C1608 JB 1H 102K-T	T	79.3/119.1
C524	4030006910	S.CER C1608 CH 1H 0R5C-T	T	79.9/120.9
C525	4030004720	S.CER C2012 JB 1H 102K-T	T	86.7/112.1
C526	4030007150	S.CER C1608 CH 1H 151J-T	B	113.3/121.5
C527	4030007150	S.CER C1608 CH 1H 151J-T	B	111.1/127.8
C528	4030006860	S.CER C1608 JB 1H 102K-T	B	96.2/114.5
C530	4030011230	S.CER GRM31M2C2H390JV01L (GRM42-6 CH)	T	120.8/113.3
C531	4030018770	S.CER C3216 CH 2J 102J-T	B	106/109.3
C532	4030018770	S.CER C3216 CH 2J 102J-T	B	103.1/109.2
C533	4030018770	S.CER C3216 CH 2J 102J-T	T	118.6/107
C534	4030017880	S.CER ERF22X 6C2H 560J D01L (GRM111)	B	112.7/103.9

M.=Mounted side (T: Mounted on the Top side, B: Mounted on the Bottom side) S.=Surface mount

[PA UNIT]

REF NO.	PARTS NO.	DESCRIPTION	M.	H/V LOCATION
C535	4030017880	S.CER ERF22X 6C2H 560J D01L (GRM111)	B	124.1/103.9
C536	4030017980	S.CER ERF22X 6C2H 470J D01L	T	101/110.8
C537	4030017940	S.CER ERF22X 6C2H 680J D01L	T	101/114.2
C538	4030017880	S.CER ERF22X 6C2H 560J D01 (GRM111)	T	131.2/117.5
C541	4030011060	S.CER GRM31M2C2H4R0CY21L (GRM42-6 CH)	T	125.1/123.7
C542	4030012480	S.CER GRM31M2C2H121JV01L (GRM42-6 CH)	T	123.4/128.7
C544	4030011730	S.CER GRM31M2C2H101JV01L (GRM42-6 CH)	T	129.9/123.5
C545	4030017940	S.CER ERF22X 6C2H 680J D01L	B	112.7/109.9
C551	4030006880	S.CER C1608 JB 1H 472K-T	T	80.1/117.1
C552	4030006860	S.CER C1608 JB 1H 102K-T	T	73/120.5
C553	4030006850	S.CER C1608 JB 1H 471K-T	T	69.4/114.7
C554	4030006860	S.CER C1608 JB 1H 102K-T	T	66.8/114.7
C555	4030006860	S.CER C1608 JB 1H 102K-T	T	63.1/111.7
C556	4030011600	S.CER C1608 JB 1E 104K-T	T	68.3/111.2
C557	4030006860	S.CER C1608 JB 1H 102K-T	T	70.8/108.5
C558	4030006860	S.CER C1608 JB 1H 102K-T	T	65.4/108.6
C559	4030006860	S.CER C1608 JB 1H 102K-T	T	66/103.5
C560	4030006860	S.CER C1608 JB 1H 102K-T	B	65.3/112.9
C561	4030006850	S.CER C1608 JB 1H 471K-T	T	70.1/105.3
C562	4030006860	S.CER C1608 JB 1H 102K-T	T	69.2/94.9
C563	4030006860	S.CER C1608 JB 1H 102K-T	T	62.3/106.1
C564	4030006860	S.CER C1608 JB 1H 102K-T	T	65/97
C565	4030006860	S.CER C1608 JB 1H 102K-T	T	62.3/103
C567	4030006860	S.CER C1608 JB 1H 102K-T	T	69.2/120.9
C601	4030011070	S.CER GRM31M2C2H5R0CY21L (GRM42-6 CH)	T	69.5/132.7
C602	4030011090	S.CER GRM31M2C2H7R0DV01L (GRM42-6 CH)	T	67/136.8
C701	4030017320	S.CER GRM21BB11H104KA01L (GRM40-034)	B	109.8/33.4
C702	4030006860	S.CER C1608 JB 1H 102K-T	B	107.7/33.2
C703	4030011600	S.CER C1608 JB 1E 104K-T	B	83.8/16.9
C704	4510004601	ELE 16 ME 1000 HC		
C705	4030011600	S.CER C1608 JB 1E 104K-T	B	79/16.9
C706	4510004601	ELE 16 ME 1000 HC		
C707	4030017320	S.CER GRM21BB11H104KA01L (GRM40-034)	B	67.1/18.6
C708	4030006900	S.CER C1608 JB 1H 103K-T	T	63.2/27.8
C709	4030006860	S.CER C1608 JB 1H 102K-T	T	63.2/26.5
C710	4030006850	S.CER C1608 JB 1H 471K-T	T	63.2/25.2
C711	4030007170	S.CER C1608 CH 1H 221J-T	T	63.2/23.9
C712	4030007170	S.CER C1608 CH 1H 221J-T	B	70.4/18.7
C713	4510004591	ELE 16 ME 470 HC		
C715	4030006860	S.CER C1608 JB 1H 102K-T	B	97.1/118.9
C718	4030011600	S.CER C1608 JB 1E 104K-T	B	128.4/19.3
C719	4030011600	S.CER C1608 JB 1E 104K-T	T	125.8/16.4
C720	4030011600	S.CER C1608 JB 1E 104K-T	B	130.5/38.7
C722	4030007130	S.CER C1608 CH 1H 101J-T	T	88.9/17
C723	4030007130	S.CER C1608 CH 1H 101J-T	T	78.3/3.1
C724	4030011340	S.CER C1608 CH 1H 471J-T	B	134.8/12.2
C725	4550007350	S.TAN F931C226MCMCMBMA	B	126.6/35.3
C726	4030006860	S.CER C1608 JB 1H 102K-T	B	91.3/111
C727	4030006860	S.CER C1608 JB 1H 102K-T	B	84.4/114.1
C728	4030006860	S.CER C1608 JB 1H 102K-T	B	91.2/112.6
C729	4030006860	S.CER C1608 JB 1H 102K-T	B	65.1/114.8
C732	4030011600	S.CER C1608 JB 1E 104K-T	T	71.8/2.6
C733	4030011600	S.CER C1608 JB 1E 104K-T	T	66.8/12.9
C734	4030006860	S.CER C1608 JB 1H 102K-T	B	63.5/1.8
C735	4030011600	S.CER C1608 JB 1E 104K-T	T	74.1/13.2
C736	4030011600	S.CER C1608 JB 1E 104K-T	B	67.3/1.8
C737	4030011600	S.CER C1608 JB 1E 104K-T	B	65.4/1.8
C738	4030011600	S.CER C1608 JB 1E 104K-T	B	68.2/14.5
C739	4030011600	S.CER C1608 JB 1E 104K-T	B	69.8/14.5
C741	4030011600	S.CER C1608 JB 1E 104K-T	B	78.5/6.4
C742	4030011600	S.CER C1608 JB 1E 104K-T	T	69.4/12.9
C743	4030006860	S.CER C1608 JB 1H 102K-T	T	68.1/12.9
C744	4030011600	S.CER C1608 JB 1E 104K-T	T	70.7/12.9
C745	4030011600	S.CER C1608 JB 1E 104K-T	B	77.7/14.3
C746	4030011600	S.CER C1608 JB 1E 104K-T	B	76.2/15.1
C747	4030011600	S.CER C1608 JB 1E 104K-T	T	98.5/4.1
C749	4030011600	S.CER C1608 JB 1E 104K-T	T	96.6/6.4
C750	4030006880	S.CER C1608 JB 1H 472K-T	T	94.2/6.4
C751	4030006860	S.CER C1608 JB 1H 102K-T	T	95.4/6.4
C752	4030011600	S.CER C1608 JB 1E 104K-T	T	93/6.4
C753	4030006880	S.CER C1608 JB 1H 472K-T	B	59.9/10.7
C754	4030006860	S.CER C1608 JB 1H 102K-T	B	66.6/14.5
C755	4030006860	S.CER C1608 JB 1H 102K-T	B	58.5/119.2
C757	4030011600	S.CER C1608 JB 1E 104K-T	B	76.4/8
C759	4030006880	S.CER C1608 JB 1H 472K-T	T	72.8/13.2
C760	4030006880	S.CER C1608 JB 1H 472K-T	B	74.8/8
C761	4030006880	S.CER C1608 JB 1H 472K-T	B	73.2/8
C762	4030006880	S.CER C1608 JB 1H 472K-T	B	70/8
C763	4030006880	S.CER C1608 JB 1H 472K-T	B	71.6/8
C764	4030006880	S.CER C1608 JB 1H 472K-T	B	61.9/1.8
C765	4030011600	S.CER C1608 JB 1E 104K-T	B	68.9/1.8
C766	4030006860	S.CER C1608 JB 1H 102K-T	B	66.5/8.7
C781	4030006860	S.CER C1608 JB 1H 102K-T	T	73/90.1
C782	4030006900	S.CER C1608 JB 1H 103K-T	T	71.8/84.3
C783	4030006880	S.CER C1608 JB 1H 472K-T	T	71.8/83.1
C801	4030007070	S.CER C1608 CH 1H 330J-T	T	55/58.5
C802	4030009470	S.CER C1608 CH 1H R75C-T	T	53.7/58.5
C803	4030007100	S.CER C1608 CH 1H 560J-T	T	53.8/53.2
C804	4030007030	S.CER C1608 CH 1H 150J-T	T	56.2/52.5
C805	4030007080	S.CER C1608 CH 1H 390J-T	T	53.8/51.6

[PA UNIT]

REF NO.	PARTS NO.	DESCRIPTION	M.	H/V LOCATION
C806	4030006880	S.CER C1608 JB 1H 472K-T	B	47.1/39.8
C807	4030011600	S.CER C1608 JB 1E 104K-T	B	43.2/38.6
C808	4030011600	S.CER C1608 JB 1E 104K-T	B	43.1/44.5
C820	4030011600	S.CER C1608 JB 1E 104K-T	B	54.1/91.2
C821	4030006880	S.CER C1608 JB 1H 472K-T	B	53.5/99.2
C822	4030011510	S.CER GRM31M2C2H560JV01L (GRM42-6 CH)	B	42.2/21.9
C823	4030011190	S.CER GRM31M2C2H270JV01L (GRM42-6 CH)	B	32.9/18.3
C824	4030012480	S.CER GRM31M2C2H121JV01L (GRM42-6 CH)	B	25.1/17.1
C825	4030011240	S.CER GRM31M2C2H470JV01L (GRM42-6 CH)	B	17.9/15.7
C826	4030011550	S.CER GRM31M2C2H680JV01L (GRM42-6 CH)	B	11.2/19.9
C827	4030011510	S.CER GRM31M2C2H560JV01L (GRM42-6 CH)	B	8.8/19.9
C828	4030006880	S.CER C1608 JB 1H 472K-T	T	5.2/106.7
C829	4030011600	S.CER C1608 JB 1E 104K-T	T	2.6/106.7
C830	4030011210	S.CER GRM31M2C2H330JV01L (GRM42-6 CH)	B	22.4/17.1
C831	4030006880	S.CER C1608 JB 1H 472K-T	B	7.5/109.2
C832	4030006880	S.CER C1608 JB 1H 472K-T	B	51.5/95.4
C833	4030011730	S.CER GRM31M2C2H101JV01L (GRM42-6 CH)	B	27.5/17.1
C835	4030012480	S.CER GRM31M2C2H121JV01L (GRM42-6 CH)	B	16.6/107.1
C836	4030012480	S.CER GRM31M2C2H121JV01L (GRM42-6 CH)	B	12.5/107.8
C837	4030012480	S.CER GRM31M2C2H121JV01L (GRM42-6 CH)	B	12.5/105.7
C840	4030011600	S.CER C1608 JB 1E 104K-T	B	42.8/97.3
C841	4030006880	S.CER C1608 JB 1H 472K-T	B	46/98.5
C842	4030011730	S.CER GRM31M2C2H101JV01L (GRM42-6 CH)	B	39/106.8
C843	4010008160	CER HM13SJ SL 431J 500V 1		
C844	4030011730	S.CER GRM31M2C2H101JV01L (GRM42-6 CH)	B	25.9/102.9
C845	4030014460	S.CER GRM31M2C2H820JV01L (GRM42-6 CH)	B	19.7/91.9
C846	4010005370	CER HM11SJ SL 331J 500V 1		
C847	4010005930	CER HM11SJ SL 391J 500V 1		
C848	4030011190	S.CER GRM31M2C2H270JV01L (GRM42-6 CH)	B	12.5/98.2
C849	4030011180	S.CER GRM31M2C2H220JV01L (GRM42-6 CH)	B	12.6/96.1
C850	4010005930	CER HM11SJ SL 391J 500V 1		
C851	4030012480	S.CER GRM31M2C2H121JV01L (GRM42-6 CH)	B	20.2/112
C852	4030006880	S.CER C1608 JB 1H 472K-T	T	5.3/90.5
C853	4030011600	S.CER C1608 JB 1E 104K-T	T	2.6/90.5
C854	4030006880	S.CER C1608 JB 1H 472K-T	B	7.7/92.8
C855	4030011730	S.CER GRM31M2C2H101JV01L (GRM42-6 CH)	B	27.9/104.9
C856	4030011510	S.CER GRM31M2C2H560JV01L (GRM42-6 CH)	B	31.2/105.5
C857	4030012480	S.CER GRM31M2C2H121JV01L (GRM42-6 CH)	B	43.1/108.3
C858	4030011730	S.CER GRM31M2C2H101JV01L (GRM42-6 CH)	B	20.2/109.9
C860	4030011600	S.CER C1608 JB 1E 104K-T	B	43.4/83.8
C861	4030006880	S.CER C1608 JB 1H 472K-T	B	46.6/83.8
C863	4030011170	S.CER GRM31M2C2H180JV01L (GRM42-6 CH)	B	37.5/93.5
C864	4030011510	S.CER GRM31M2C2H560JV01L (GRM42-6 CH)	B	28.5/82.6
C865	4030011110	S.CER GRM31M2C2H9R0DV01L (GRM42-6 CH)	B	29.4/78.6
C866	4030011230	S.CER GRM31M2C2H390JV01L (GRM42-6 CH)	B	24.4/78
C868	4030011240	S.CER GRM31M2C2H470JV01L (GRM42-6 CH)	B	26.8/78.6
C869	4030011180	S.CER GRM31M2C2H220JV01L (GRM42-6 CH)	B	10.3/83.5
C870	4030011170	S.CER GRM31M2C2H180JV01L (GRM42-6 CH)	B	17/77.7
C871	4030006880	S.CER C1608 JB 1H 472K-T	T	5.2/74.4
C872	4030011600	S.CER C1608 JB 1E 104K-T	T	2.5/74.4
C873	4030011070	S.CER GRM31M2C2H5R0CY21L (GRM42-6 CH)	B	33.2/92.6
C874	4030006880	S.CER C1608 JB 1H 472K-T	B	9/74.5
C876	4030011160	S.CER GRM31M2C2H150JV01L (GRM42-6 CH)	B	22/77.4
C880	4030011600	S.CER C1608 JB 1E 104K-T	B	43.4/69.1
C881	4030006880	S.CER C1608 JB 1H 472K-T	B	47/69.1
C882	4010007590	CER HM15SJ SL 681J 500V 1		
C883	4010007590	CER HM15SJ SL 681J 500V 1		
C884	4010005930	CER HM11SJ SL 391J 500V 1		
C885	4320000320	DIP DM20C 222J5		
C886	4030012480	S.CER GRM31M2C2H121JV01L (GRM42-6 CH)	B	31.5/57.2
C887	4030011730	S.CER GRM31M2C2H101JV01L (GRM42-6 CH)	B	33.9/57.2
C889	4030014460	S.CER GRM31M2C2H820JV01L (GRM42-6 CH)	B	18/65.3
C890	4320001250	DIP DM19C 162J5		
C893	4030006880	S.CER C1608 JB 1H 472K-T	T	5.3/58.3
C894	4030011600	S.CER C1608 JB 1E 104K-T	T	2.6/58.3
C900	4030011600	S.CER C1608 JB 1E 104K-T	B	44/54.4

M.=Mounted side (T: Mounted on the Top side, B: Mounted on the Bottom side) S.=Surface mount

[PA UNIT]

REF NO.	PARTS NO.	DESCRIPTION	M.	H/V LOCATION
C901	4030006880	S.CER C1608 JB 1H 472K-T	B	46.8/54.4
C902	4010005870	CER HM95SJ SL 221J 500V 1		
C903	4030011190	S.CER GRM31M2C2H270JV01L (GRM42-6 CH)	B	30.9/42.7
C904	4030014460	S.CER GRM31M2C2H820JV01L (GRM42-6 CH)	B	28.4/42.7
C905	4010005870	CER HM95SJ SL 221J 500V 1		
C906	4030011510	S.CER GRM31M2C2H560JV01L (GRM42-6 CH)	B	17/44
C907	4030011510	S.CER GRM31M2C2H560JV01L (GRM42-6 CH)	B	10.8/49.5
C908	4030006880	S.CER C1608 JB 1H 472K-T	T	5.3/42.1
C909	4030011600	S.CER C1608 JB 1E 104K-T	B	2.6/42.1
C920	4030011600	S.CER C1608 JB 1E 104K-T	T	43.2/25.1
C921	4030006880	S.CER C1608 JB 1H 472K-T	B	47.1/25.4
C922	4010007590	CER HM15SJ SL 681J 500V 1		
C923	4030011730	S.CER GRM31M2C2H101JV01L (GRM42-6 CH)	B	31.4/27.3
C924	4010006410	CER HM13SJ SL 471J 500V 1		
C925	4030014460	S.CER GRM31M2C2H820JV01L (GRM42-6 CH)	B	15.7/29.5
C926	4010006410	CER HM13SJ SL 471J 500V 1		
C927	4010005930	CER HM11SJ SL 391J 500V 1		
C928	4010005930	CER HM11SJ SL 391J 500V 1		
C929	4030006880	S.CER C1608 JB 1H 472K-T	T	5.3/25.8
C930	4030011600	S.CER C1608 JB 1E 104K-T	T	2.6/25.8
C931	4030014460	S.CER GRM31M2C2H820JV01L (GRM42-6 CH)	B	34.1/27.3
C932	4030011730	S.CER GRM31M2C2H101JV01L (GRM42-6 CH)	B	33.3/32.4
C933	4030011730	S.CER GRM31M2C2H101JV01L (GRM42-6 CH)	B	29.7/30.9
C940	4030011600	S.CER C1608 JB 1E 104K-T	B	43.6/11.1
C941	4030006880	S.CER C1608 JB 1H 472K-T	B	43.6/14.2
C942	4030014460	S.CER GRM31M2C2H820JV01L (GRM42-6 CH)	B	39.5/119.2
C943	4030011210	S.CER GRM31M2C2H330JV01L (GRM42-6 CH)	B	28.9/111.7
C944	4030014460	S.CER GRM31M2C2H820JV01L (GRM42-6 CH)	B	24.7/118.4
C945	4030011170	S.CER GRM31M2C2H180JV01L (GRM42-6 CH)	B	16.5/118.1
C947	4030006880	S.CER C1608 JB 1H 472K-T	T	5.3/9.9
C948	4030011600	S.CER C1608 JB 1E 104K-T	T	2.6/9.9
C949	4030011050	S.CER GRM31M3C2H3R0CY21L (GRM42-6 CJ)	B	28.9/109.6
C960	4030010760	S.CER C1608 CH 1H 331J-T	T	18.1/130.2
C961	4030011600	S.CER C1608 JB 1E 104K-T	B	45.1/134.1
C962	4030006880	S.CER C1608 JB 1H 472K-T	B	39/137.8
C963	4030006880	S.CER C1608 JB 1H 472K-T	B	38.7/126.3
C964	4610002120	S.TRI TZB4Z100EB10R00 (TZBX4Z100BE110)	T	3.3/126.6
C966	4030006880	S.CER C1608 JB 1H 472K-T	B	21.2/131.2
C968	4030011340	S.CER C1608 CH 1H 471J-T	B	31/130.5
C969	4030011340	S.CER C1608 CH 1H 471J-T	B	31/133.6
C970	4030010760	S.CER C1608 CH 1H 331J-T	B	22/132.8
C971	4030011340	S.CER C1608 CH 1H 471J-T	B	35.8/133.6
C972	4030011790	S.CER GRM55RF52A684ZD01L (GRM44-1)	B	3.4/136.4
C973	4030007090	S.CER C1608 CH 1H 470J-T	B	8.3/129.8
C979	4030006880	S.CER C1608 JB 1H 472K-T	T	51.8/38.6
C987	4030006880	S.CER C1608 JB 1H 472K-T	B	28.9/3.3
C988	4030006880	S.CER C1608 JB 1H 472K-T	B	26.3/3.3
C989	4030006880	S.CER C1608 JB 1H 472K-T	B	25/2.6
C990	4030006880	S.CER C1608 JB 1H 472K-T	T	20.6/3
C991	4030006880	S.CER C1608 JB 1H 472K-T	T	20.6/4.2
C992	4030006880	S.CER C1608 JB 1H 472K-T	T	20.6/5.4
C993	4030006880	S.CER C1608 JB 1H 472K-T	T	20.6/6.6
C994	4030011600	S.CER C1608 JB 1E 104K-T	B	29.5/6.1
C995	4030006880	S.CER C1608 JB 1H 472K-T	B	23.7/3.4
C996	4030007090	S.CER C1608 CH 1H 470J-T	T	20.6/9
C997	4030007090	S.CER C1608 CH 1H 470J-T	T	20.6/7.8
C998	4030007090	S.CER C1608 CH 1H 470J-T	T	20.6/10.2
C999	4030006860	S.CER C1608 JB 1H 102K-T	T	56.8/9.5
C1000	4030006860	S.CER C1608 JB 1H 102K-T	B	55.5/5
C1001	4030011600	S.CER C1608 JB 1E 104K-T	B	51.6/1.7
C1002	4030006880	S.CER C1608 JB 1H 472K-T	B	27.6/2.6
C1003	4030011600	S.CER C1608 JB 1E 104K-T	T	49.8/7.6
C1004	4030011510	S.CER GRM31M2C2H560JV01L (GRM42-6 CH)	B	39.8/21.9
C1005	4030011550	S.CER GRM31M2C2H680JV01L (GRM42-6 CH)	B	16.8/91.9
C1006	4030014460	S.CER GRM31M2C2H820JV01L (GRM42-6 CH)	B	39/109.2
C1007	4030011550	S.CER GRM31M2C2H680JV01L (GRM42-6 CH)	B	18.1/62.1
C1009	4030011510	S.CER GRM31M2C2H560JV01L (GRM42-6 CH)	B	20.6/118.7
C1010	4030014460	S.CER GRM31M2C2H820JV01L (GRM42-6 CH)	B	27.1/119.5
C1121	4010006410	CER HM13SJ SL 471J 500V 1		
RL701	6330001550	REL JV-12-KT		
RL801	6330001721	REL ATN207-K1		
RL820	6330001721	REL ATN207-K1		
RL821	6330001721	REL ATN207-K1		
RL840	6330001721	REL ATN207-K1		
RL841	6330001721	REL ATN207-K1		

[PA UNIT]

REF NO.	PARTS NO.	DESCRIPTION	M.	H/V LOCATION
RL860	6330001721	REL ATN207-K1		
RL861	6330001721	REL ATN207-K1		
RL880	6330001721	REL ATN207-K1		
RL881	6330001721	REL ATN207-K1		
RL900	6330001721	REL ATN207-K1		
RL901	6330001721	REL ATN207-K1		
RL920	6330001721	REL ATN207-K1		
RL921	6330001721	REL ATN207-K1		
RL940	6330001721	REL ATN207-K1		
RL941	6330001721	REL ATN207-K1		
J2	6510023511	S.CON 28FLT-SM2-TB(LF)(SN) 2	T	80.1/6
J980	6510023511	S.CON 28FLT-SM2-TB(LF)(SN) 2	T	63.7/6
F1	5220000341	HOL FHA010-03F		
F2	5210000940	FUS 1205		
W701	8900013900	CAB OPC-1455		
W702	8900013910	CAB OPC-1456		
W801	7120000480	S.JUM MJP-0.4-T	B	8.3/100.9
W901	7120000480	S.JUM MJP-0.4-T	T	56.7/22
EP202	6910012350	S.BEA MMZ1608Y 102BT	B	136/51.3
EP703	6910012350	S.BEA MMZ1608Y 102BT	B	142.6/13.9
EP741	6910012350	S.BEA MMZ1608Y 102BT	B	76.4/11.9
EP742	6910012350	S.BEA MMZ1608Y 102BT	B	77.8/11.3
EP743	6910012350	S.BEA MMZ1608Y 102BT	B	59.8/99.5
EP747	6910012350	S.BEA MMZ1608Y 102BT	T	65/9.6
EP748	6910012350	S.BEA MMZ1608Y 102BT	T	63.8/9.6
EP751	6910012350	S.BEA MMZ1608Y 102BT	T	74.1/9.6
EP752	6910012350	S.BEA MMZ1608Y 102BT	B	63.4/5.2
EP753	6910012350	S.BEA MMZ1608Y 102BT	T	66.4/9.6
EP754	6910012350	S.BEA MMZ1608Y 102BT	B	59.3/115.8
EP756	6910012350	S.BEA MMZ1608Y 102BT	T	68.6/2.6
EP758	6910012350	S.BEA MMZ1608Y 102BT	T	70.3/9.6
EP759	6910012350	S.BEA MMZ1608Y 102BT	T	69.1/9.6
EP760	6910012350	S.BEA MMZ1608Y 102BT	T	60.6/10
EP761	6910012350	S.BEA MMZ1608Y 102BT	T	62.5/9.6
EP762	6910012350	S.BEA MMZ1608Y 102BT	B	61/4.6
EP763	6910012350	S.BEA MMZ1608Y 102BT	B	63.3/105.6
EP767	6910012350	S.BEA MMZ1608Y 102BT	B	76.4/5.2
EP772	6910012350	S.BEA MMZ1608Y 102BT	T	96.4/3.8
EP774	6910012350	S.BEA MMZ1608Y 102BT	T	72.8/9.6
EP775	6910012350	S.BEA MMZ1608Y 102BT	B	74.8/5.2
EP776	6910012350	S.BEA MMZ1608Y 102BT	B	73.2/5.2
EP777	6910012350	S.BEA MMZ1608Y 102BT	B	70/5.2
EP778	6910012350	S.BEA MMZ1608Y 102BT	B	71.6/5.2
EP779	6910012350	S.BEA MMZ1608Y 102BT	B	68.2/5.2

M.=Mounted side (T: Mounted on the Top side, B: Mounted on the Bottom side)
S.=Surface mount

[DRIVER UNIT]

REF NO.	PARTS NO.	DESCRIPTION	M.	H/V LOCATION
Q504	1590003061	S.FET PD55015-E	T	20/9.7
R102	7070000271	RES ERG1SJ 101 (100)		
C101	4030004750	S.CER C2012 JB 1H 103K-T	T	24.6/18.2
C102	4030011230	S.CER GRM31M2C2H390JV01L (GRM42-6 CH)	T	11.2/4.2
J101	6910016830	CON IMSA-9230B-1-04Z149-PT1		
J102	6910016830	CON IMSA-9230B-1-04Z149-PT1		
J103	6910016830	CON IMSA-9230B-1-04Z149-PT1		
J104	6910016830	CON IMSA-9230B-1-04Z149-PT1		
J107	6910016830	CON IMSA-9230B-1-04Z149-PT1		
MP1	8410002480	S.HEA 2429 PA HEATSINK	B	20/9.7

[DISPLAY UNIT]

REF NO.	PARTS NO.	DESCRIPTION	M.	H/V LOCATION
IC1	6910016730	S.DC XC9504B092ARN	B	44.4/9.4
IC101	1180001071	S.IC TA7805F(TE16L,Q)	B	90.3/6.9
IC151	1180002201	S.IC RN5FZ33BA-TR-F	B	99.9/4.8
IC301	1110002751	S.IC TA75S01F(TE85R,F)	B	113.8/7.5
IC506	1120003010	S.IC ANE253FH-V	B	69/38.5
IC651	1110005420	S.IC BA15532F-E2	B	4.1/25.6
IC2003	1140013140	S.IC HD64338020SB68HV(SX-2427C)	B	93/26.3
IC2007	1110005821	S.IC R3112N281A-TR-F	B	108.7/46.9
Q1	1550000090	S.FET RSQ035P03TR	B	39.4/9.8
Q51	1560001330	S.FET RSR025N03	B	52.1/10.6
Q301	1560001290	S.FET 2SK3065 T100	T	110.8/31.4
Q302	1590003940	S.TRA RN1105(TE85L,F)	T	116.7/10.2
Q303	1590003930	S.TRA UMD22N TR	T	113.1/11.5
Q651	1590001650	S.TRA XP4601(TX)	B	10.6/28.8
Q652	1590001650	S.TRA XP4601(TX)	B	11.1/20.6
Q653	1590001650	S.TRA XP4601(TX)	B	10.6/26.2
Q654	1590001650	S.TRA XP4601(TX)	B	11.1/17
Q701	1530002060	S.TRA 2SC4081 T106 R	T	19.1/50.3
Q721	1530002060	S.TRA 2SC4081 T106 R	T	22/5.8
Q741	1530002060	S.TRA 2SC4081 T106 R	T	94/50.1
Q761	1530002060	S.TRA 2SC4081 T106 R	T	104.2/50.1
Q771	1530002060	S.TRA 2SC4081 T106 R	T	18.4/25.1
Q781	1530002060	S.TRA 2SC4081 T106 R	T	5.3/23.6
Q802	1520000460	S.TRA 2SB1132 T100 R	B	58.8/21.6
Q851	1590002771	S.FET CPH3404-TL-E	B	39.9/18.4
Q2001	1590003940	S.TRA RN1105(TE85L,F)	B	81.6/23.7
Q2002	1590001870	S.TRA DTA114EE TL	B	80.1/29.7
Q2003	1590003480	S.TRA DTC114TE TL	B	82.2/32.3
D1	1790000970	S.DIO MA729(TX)	B	36.8/10.1
D51	1750000730	S.DIO MA25D1000L	B	51/8
D301	1790001250	S.DIO MA2S111-(TX)	B	111/32
D302	1790001520	S.ZEN MA8075-L(TX)	B	109.9/7.6
D601	1750000950	S.DIO MA732(TX)	B	51.5/39.8
D602	1750000950	S.DIO MA732(TX)	B	53.3/39.8
D801	1730002340	S.ZEN MA8047-M(TX)	B	35/40.4
D802	1730002340	S.ZEN MA8047-M(TX)	B	39.8/25.9
D803	1730002340	S.ZEN MA8047-M(TX)	B	39.5/22.8
D804	1730002340	S.ZEN MA8047-M(TX)	B	42/22.9
D2001	1750000950	S.DIO MA732(TX)	T	107.4/26.5
D2002	1790001670	S.DIO RB706F-40T106	B	76.6/16.8
D2003	1790001670	S.DIO RB706F-40T106	T	116.4/36.7
D2004	1750000370	S.DIO DA221 TL	T	100.6/41.8
D2005	1750000370	S.DIO DA221 TL	B	101.7/42.8
D2006	1750000370	S.DIO DA221 TL	B	107.3/5.9
X501	6050012150	S.XTA CR-806 SMD-49TA 4.433619MHz [EUR]	B	87/43.5
	6050012150	S.XTA CR-806 SMD-49TA 4.433619 MHz [FRA]		
	6050012150	S.XTA CR-806 SMD-49TA 4.433619 MHz [ESP]		
	6050012140	S.XTA CR-805 SMD-49TA 3.579545 MHz [USA]		
	6050012150	S.XTA CR-806 SMD-49TA 4.433619 MHz [EXP]		
	6050012150	S.XTA CR-806 SMD-49TA 4.433619 MHz [ITR]		
	6050012150	S.XTA CR-806 SMD-49TA 4.433619 MHz [UK]		
	6050012140	S.XTA CR-805 SMD-49TA 3.579545 MHz [KOR]		
	6050012150	S.XTA CR-806 SMD-49TA 4.433619 MHz [AUS]		
	6050012150	S.XTA CR-806 SMD-49TA 4.433619 MHz [CHN]		
X2001	6050011550	S.XTA CR-747 SMD-49TA 9.8304 MHz	B	106.5/27

[DISPLAY UNIT]

REF NO.	PARTS NO.	DESCRIPTION	M.	H/V LOCATION
L1	6190001561	S.COI CDRH5D18NP-101NC	B	68.4/6.3
L2	6190001561	S.COI CDRH5D18NP-101NC	B	34.6/5.2
L3	6200002041	S.COI NLV25T-101J	B	30.7/10.4
L51	6190001561	S.COI CDRH5D18NP-101NC	B	55.9/6.2
L53	6200002041	S.COI NLV25T-101J	B	60.9/10.9
L101	6200001831	S.COI NLV32T-100J	B	96/11.6
L151	6200001831	S.COI NLV32T-100J	B	96/8.6
L152	6200001831	S.COI NLV32T-100J	B	100.6/11.4
L251	6200003950	S.COI HF50ACC 322513-T	B	145.8/44
L252	6200003950	S.COI HF50ACC 322513-T	B	145.2/50.9
L301	6200002041	S.COI NLV25T-101J	B	109.6/16.7
L302	6200005011	S.COI NLV25T-100J	T	112.6/24
L303	6200002041	S.COI NLV25T-101J	T	112/20.3
L306	6200003261	S.COI NLV32T-101J	T	109.8/25.5
L307	6200002041	S.COI NLV25T-101J	T	115.4/26.6
L309	6200002041	S.COI NLV25T-101J	T	115.3/24
L310	6200002041	S.COI NLV25T-101J	T	115.4/21.5
L312	6200002041	S.COI NLV25T-101J	T	115.4/19
L313	6200002041	S.COI NLV25T-101J	T	115.7/16.3
L505	6200005521	S.COI NLV25T-470J	B	71.2/47.9
L506	6200005011	S.COI NLV25T-100J	B	67.9/20.2
L507	6200005011	S.COI NLV25T-100J	B	50.2/29
L508	6200005011	S.COI NLV25T-100J	B	49.3/24.3
L509	6200005011	S.COI NLV25T-100J	B	17.4/35.6
L601	6200002041	S.COI NLV25T-101J	B	70.6/25.2
L602	6200005011	S.COI NLV25T-100J	B	53.5/36.2
L603	6200005011	S.COI NLV25T-100J	B	51/43.3
L604	6200005011	S.COI NLV25T-100J	B	53.5/43.3
L605	6200005011	S.COI NLV25T-100J	B	50.9/36.2
L651	6200002041	S.COI NLV25T-101J	B	19.1/42.7
L701	6200002041	S.COI NLV25T-101J	B	21.1/37.5
L702	6200002041	S.COI NLV25T-101J	B	65.4/10.9
L703	6200002041	S.COI NLV25T-101J	B	27.9/11.3
L801	6200005011	S.COI NLV25T-100J	B	63.4/16.9
L802	6200002041	S.COI NLV25T-101J	B	19.1/47.5
L851	6200003950	S.COI HF50ACC 322513-T	B	33.2/17.2
L852	6200003950	S.COI HF50ACC 322513-T	B	35/21.3
L853	6200002041	S.COI NLV25T-101J	B	34.4/26.6
L854	6200002041	S.COI NLV25T-101J	B	34.4/24.1
L855	6200003950	S.COI HF50ACC 322513-T	B	36.4/17.2
R1	7030008141	S.RES ERA3YKD 224V (220K)	B	33.4/9.6
R2	7030005671	S.RES ERA3YKD 393V (39K)	B	33.4/11.6
R3	7030008051	S.RES ERA3YKD 184V (180K)	B	42.6/6.4
R4	7030005050	S.RES ERJ2GEJ 103 X (10K)	B	40.9/6.8
R5	7030005050	S.RES ERJ2GEJ 103 X (10K)	B	40.9/7.7
R51	7030008141	S.RES ERA3YKD 224V (220K)	B	49.7/10.8
R52	7030007911	S.RES ERA3YKD 563V (56K)	B	48.5/10.8
R53	7030006561	S.RES ERA3YED 223V (22K)	B	46.5/11.8
R54	7030005050	S.RES ERJ2GEJ 103 X (10K)	B	47.9/8.4
R55	7030005050	S.RES ERJ2GEJ 103 X (10K)	B	48.8/8.4
R201	7030010040	S.RES ERJ2GEJ-JPW	B	109.6/39
R202	7030010040	S.RES ERJ2GEJ-JPW	B	109.6/39
R251	7030005120	S.RES ERJ2GEJ 102 X (1K)	B	136.5/49.6
R252	7030000300	S.RES MCR10EZHZ 220 (221)	B	133.9/47.3
R253	7030000300	S.RES MCR10EZHZ 220 (221)	B	141.3/51.5
R254	7030000300	S.RES MCR10EZHZ 220 (221)	B	133.9/49
R255	7030000300	S.RES MCR10EZHZ 220 (221)	T	142.6/51.4
R301	7030005120	S.RES ERJ2GEJ 102 X (1K)	B	113.2/32
R302	7030005050	S.RES ERJ2GEJ 103 X (10K)	T	114/30.4
R303	7030005120	S.RES ERJ2GEJ 102 X (1K)	B	111/33.4
R304	7030007300	S.RES ERJ2GEJ 332 X (3.3K)	B	111.9/30.4
R305	7030007300	S.RES ERJ2GEJ 332 X (3.3K)	B	113.2/32.9
R306	7030005120	S.RES ERJ2GEJ 102 X (1K)	T	114.9/11
R307	7030005050	S.RES ERJ2GEJ 103 X (10K)	B	111.3/8.4
R308	7030005230	S.RES ERJ2GEJ 334 X (330K)	B	113.8/5.3
R309	7030005310	S.RES ERJ2GEJ 124 X (120K)	B	112/5.3
R310	7030008010	S.RES ERJ2GEJ 123 X (12K)	B	110.2/5.3
R521	7030008370	S.RES ERJ2GEJ 561 X (560)	B	61.8/46.2
R522	7030010040	S.RES ERJ2GEJ-JPW	B	65.3/47.4
R523	7030010040	S.RES ERJ2GEJ-JPW	B	65.4/48.7
R524	7030010900	S.RES ERJ3GEYJ 750 V (75)	B	63.1/48.9
R528	7030010040	S.RES ERJ2GEJ-JPW	B	60.8/42.6
R529	7030005050	S.RES ERJ2GEJ 103 X (10K)	B	58.6/43.8
R530	7030005080	S.RES ERJ2GEJ 823 X (82K)	B	60.8/43.6
R531	7030009290	S.RES ERJ2GEJ 562 X (5.6K)	B	76.3/42.9
R532	7030005050	S.RES ERJ2GEJ 103 X (10K)	B	60.8/37.2
R533	7030010040	S.RES ERJ2GEJ-JPW	B	56.5/32.3
R534	7030010040	S.RES ERJ2GEJ-JPW	B	60.8/36
R536	7030010040	S.RES ERJ2GEJ-JPW	B	62.6/29
R537	7030010040	S.RES ERJ2GEJ-JPW	B	64.6/29
R538	7030010040	S.RES ERJ2GEJ-JPW	B	66.6/29
R539	7030005720	S.RES ERJ2GEJ 563 X (56K)	B	69.6/29
R540	7030010040	S.RES ERJ2GEJ-JPW	B	68.6/29
R541	7310004650	S.TRI EVM-2WSX80 B53 (502)	B	53.3/49.2
R544	7030010040	S.RES ERJ2GEJ-JPW	B	60.8/39.6
R545	7030005720	S.RES ERJ2GEJ 563 X (56K)	B	60.8/32
R546	7030010040	S.RES ERJ2GEJ-JPW	B	60.8/34
R547	7030010040	S.RES ERJ2GEJ-JPW	B	59.2/34.8
R548	7030010040	S.RES ERJ2GEJ-JPW	B	60.8/33
R549	7030010040	S.RES ERJ2GEJ-JPW	B	63.6/29
R550	7030010040	S.RES ERJ2GEJ-JPW	B	65.6/29
R551	7030010040	S.RES ERJ2GEJ-JPW	B	67.6/29
R553	7030010040	S.RES ERJ2GEJ-JPW	B	59.5/43.8
R601	7030008410	S.RES ERJ2GEJ 392 X (3.9K)	B	72.7/24.9
R602	7030008410	S.RES ERJ2GEJ 392 X (3.9K)	B	74.5/24.9
R603	7030008410	S.RES ERJ2GEJ 392 X (3.9K)	B	75.4/24.9
R604	7030008410	S.RES ERJ2GEJ 392 X (3.9K)	B	77.2/24.9

M.=Mounted side (T: Mounted on the Top side, B: Mounted on the Bottom side) S.=Surface mount

[DISPLAY UNIT]

REF NO.	PARTS NO.	DESCRIPTION	M.	H/V LOCATION
R605	7030008410	S.RES ERJ2GEJ 392 X (3.9K)	B	75.3/30.2
R606	7030008410	S.RES ERJ2GEJ 392 X (3.9K)	B	76.3/24.9
R608	7030010040	S.RES ERJ2GEJ-JPW	B	48.8/36.8
R609	7030005040	S.RES ERJ2GEJ 472 X (4.7K)	B	48.4/44.4
R610	7030010040	S.RES ERJ2GEJ-JPW	B	48.8/41.7
R612	7030005040	S.RES ERJ2GEJ 472 X (4.7K)	B	48.8/42.6
R613	7030003470	S.RES ERJ3GEYJ 182 V (1.8K)	B	52.6/46.1
R614	7030003470	S.RES ERJ3GEYJ 182 V (1.8K)	B	50.7/46.3
R651	7030005050	S.RES ERJ2GEJ 103 X (10K)	B	5.5/19.6
R652	7030005220	S.RES ERJ2GEJ 223 X (22K)	B	8.1/25.7
R653	7030005060	S.RES ERJ2GEJ 333 X (33K)	B	5.5/21.4
R654	7030005070	S.RES ERJ2GEJ 683 X (68K)	B	8.1/23.9
R655	7030005090	S.RES ERJ2GEJ 104 X (100K)	B	4.1/30.7
R656	7030005110	S.RES ERJ2GEJ 224 X (220K)	B	8.1/27.4
R657	7030005060	S.RES ERJ2GEJ 333 X (33K)	B	1.8/30.3
R658	7030005090	S.RES ERJ2GEJ 104 X (100K)	B	4.1/29.8
R659	7030003600	S.RES ERJ3GEYJ 223 V (22K)	B	8.4/28.5
R660	7030005720	S.RES ERJ2GEJ 563 X (56K)	B	13.2/29.9
R661	7030005220	S.RES ERJ2GEJ 223 X (22K)	B	13.7/27.1
R662	7030007350	S.RES ERJ2GEJ 393 X (39K)	B	13.7/28.7
R663	7030005220	S.RES ERJ2GEJ 223 X (22K)	B	13.2/20.6
R664	7030007340	S.RES ERJ2GEJ 153 X (15K)	B	5.7/29.8
R665	7030003600	S.RES ERJ3GEYJ 223 V (22K)	B	8.9/20.6
R666	7030004980	S.RES ERJ2GEJ 101 X (100)	B	13.1/25.3
R667	7030004980	S.RES ERJ2GEJ 101 X (100)	B	11.1/18.8
R668	7030004980	S.RES ERJ2GEJ 101 X (100)	B	9.7/24.2
R669	7030004980	S.RES ERJ2GEJ 101 X (100)	B	13.6/16.2
R701	7030004990	S.RES ERJ2GEJ 221 X (220)	T	18.4/48
R702	7030007280	S.RES ERJ2GEJ 331 X (330)	T	19.7/48
R703	7030007290	S.RES ERJ2GEJ 222 X (2.2K)	T	25.1/41
R704	7030005040	S.RES ERJ2GEJ 472 X (4.7K)	T	16.6/17.2
R705	7030007340	S.RES ERJ2GEJ 153 X (15K)	T	18.7/6.4
R721	7030004990	S.RES ERJ2GEJ 221 X (220)	T	20.2/6.2
R722	7030007280	S.RES ERJ2GEJ 331 X (330)	T	23.8/5.6
R723	7030003480	S.RES ERJ3GEYJ 222 V (2.2K)	T	47.5/2.4
R724	7030003520	S.RES ERJ3GEYJ 472 V (4.7K)	T	61.8/2.4
R725	7030003580	S.RES ERJ3GEYJ 153 V (15K)	T	75.9/2.4
R741	7030004990	S.RES ERJ2GEJ 221 X (220)	T	92.2/49.7
R742	7030007280	S.RES ERJ2GEJ 331 X (330)	T	95.7/49.6
R743	7030007290	S.RES ERJ2GEJ 222 X (2.2K)	T	102.1/35
R744	7030005040	S.RES ERJ2GEJ 472 X (4.7K)	T	102.1/25.5
R745	7030007340	S.RES ERJ2GEJ 153 X (15K)	T	100.6/8.6
R761	7030004990	S.RES ERJ2GEJ 221 X (220)	T	103.1/48.2
R762	7030007280	S.RES ERJ2GEJ 331 X (330)	T	104.8/47.8
R771	7030004990	S.RES ERJ2GEJ 221 X (220)	T	18.7/28.9
R772	7030007280	S.RES ERJ2GEJ 331 X (330)	T	18.1/29.9
R781	7030004990	S.RES ERJ2GEJ 221 X (220)	T	3.5/22.4
R782	7030007280	S.RES ERJ2GEJ 331 X (330)	T	3.5/24.2
R801	7030005240	S.RES ERJ2GEJ 473 X (47K)	B	62/21.8
R802	7030007270	S.RES ERJ2GEJ 151 X (150)	B	62/20
R803	7030005120	S.RES ERJ2GEJ 102 X (1K)	B	62/23.6
R2002	7030005240	S.RES ERJ2GEJ 473 X (47K)	T	110.4/40.7
R2003	7030005050	S.RES ERJ2GEJ 103 X (10K)	T	24.6/24.1
R2004	7030005050	S.RES ERJ2GEJ 103 X (10K)	T	24.6/26.3
R2005	7030005050	S.RES ERJ2GEJ 103 X (10K)	T	24.6/23.2
R2006	7030005050	S.RES ERJ2GEJ 103 X (10K)	T	24.6/25.3
R2007	7030007290	S.RES ERJ2GEJ 222 X (2.2K)	T	107.6/24.4
R2008	7030005220	S.RES ERJ2GEJ 223 X (22K)	T	78.2/18.4
R2009	7030005240	S.RES ERJ2GEJ 473 X (47K)	T	107.8/33
R2010	7030005090	S.RES ERJ2GEJ 104 X (100K)	B	79.6/16.9
R2011	7030005160	S.RES ERJ2GEJ 105 X (1M)	B	103.3/26.9
R2012	7030008010	S.RES ERJ2GEJ 123 X (12K)	B	103.3/23.3
R2013	7030005240	S.RES ERJ2GEJ 473 X (47K)	B	96.7/37.9
R2014	7030005290	S.RES ERJ2GEJ 682 X (6.8K)	T	24.1/41
R2015	7030005050	S.RES ERJ2GEJ 103 X (10K)	B	106/44.6
R2016	7030005240	S.RES ERJ2GEJ 473 X (47K)	B	92.1/37.9
R2017	7030005290	S.RES ERJ2GEJ 682 X (6.8K)	T	33.4/3.7
R2018	7030005290	S.RES ERJ2GEJ 682 X (6.8K)	T	102.2/41.8
R2019	7030005240	S.RES ERJ2GEJ 473 X (47K)	B	84.8/33.8
R2020	7030003450	S.RES ERJ3GEYJ 122 V (1.2K)	B	91.2/43.1
R2021	7030005240	S.RES ERJ2GEJ 473 X (47K)	B	97.1/40.8
R2022	7030005240	S.RES ERJ2GEJ 473 X (47K)	B	92.3/42.3
R2023	7030005240	S.RES ERJ2GEJ 473 X (47K)	B	100.1/42.8
R2024	7030005240	S.RES ERJ2GEJ 473 X (47K)	B	94.3/42.3
R2025	7030005240	S.RES ERJ2GEJ 473 X (47K)	B	93.3/42.3
R2026	7030005240	S.RES ERJ2GEJ 473 X (47K)	B	72.4/16.7
R2027	7030005240	S.RES ERJ2GEJ 473 X (47K)	B	70.6/16.9
R2028	7030005240	S.RES ERJ2GEJ 473 X (47K)	B	98.9/42.8
R2029	7030005240	S.RES ERJ2GEJ 473 X (47K)	B	73.5/16.7
R2030	7030007270	S.RES ERJ2GEJ 151 X (150)	T	108/11.8
R2031	7030007280	S.RES ERJ2GEJ 331 X (330)	T	108.8/40.1
R2033	7030007270	S.RES ERJ2GEJ 151 X (150)	T	19.4/20.3
R2034	7030005120	S.RES ERJ2GEJ 102 X (1K)	B	32.1/28.3
R2035	7030005120	S.RES ERJ2GEJ 102 X (1K)	B	32.5/30.9
R2036	7030005240	S.RES ERJ2GEJ 473 X (47K)	B	94.9/37.9
R2037	7030005240	S.RES ERJ2GEJ 473 X (47K)	B	93.9/37.9
R2039	7030005240	S.RES ERJ2GEJ 473 X (47K)	B	107.6/23.5
R2040	7030007340	S.RES ERJ2GEJ 153 X (15K)	B	116.3/8.7
R2041	7030007340	S.RES ERJ2GEJ 153 X (15K)	B	116.2/7.7
R2042	7030005050	S.RES ERJ2GEJ 103 X (10K)	B	79.7/31.3
R2043	7030005090	S.RES ERJ2GEJ 104 X (100K)	B	81.9/30.4
C2	4030018960	S.CER C3216 JB 1C 106MT-N	B	62.2/7
C3	4030018960	S.CER C3216 JB 1C 106MT-N	B	77/9.8
C4	4030017420	S.CER ECJ0EC1H470J	B	35.3/10.6
C6	4030018960	S.CER C3216 JB 1C 106MT-N	B	28/6
C8	4030018960	S.CER C3216 JB 1C 106MT-N	B	30.1/6
C9	4030018960	S.CER C3216 JB 1C 106MT-N	B	39.1/4.4

[DISPLAY UNIT]

REF NO.	PARTS NO.	DESCRIPTION	M.	H/V LOCATION	
C51	4030017420	S.CER ECJ0EC1H470J	B	49.7/8.4	
C53	4030018960	S.CER C3216 JB 1C 106MT-N	B	51.6/4.3	
C55	4030018960	S.CER C3216 JB 1C 106MT-N	B	56.2/11	
C56	4030018960	S.CER C3216 JB 1C 106MT-N	B	61.9/3.6	
C57	4030017490	S.CER C1608 JB 1A 105K-T	B	43.9/11.8	
C101	4030018960	S.CER C3216 JB 1C 106MT-N	B	85.7/6.8	
C102	4030018960	S.CER C3216 JB 1C 106MT-N	B	94.7/4.6	
C103	4030016930	S.CER ECJ0EB1A104K	B	91.1/12.2	
C104	4030016930	S.CER ECJ0EB1A104K	B	89.5/12.2	
C151	4550006250	S.TAN TEESVA 1A 106M8R	B	97/4.6	
C152	4550006250	S.TAN TEESVA 1A 106M8R	B	100.7/7.7	
C153	4030016930	S.CER ECJ0EB1A104K	B	99.7/2.6	
C154	4030016930	S.CER ECJ0EB1A104K	B	99.6/9.3	
C251	4030017730	S.CER ECJ0EB1E471K	B	147.5/46.4	
C252	4030017730	S.CER ECJ0EB1E471K	B	146.5/48.3	
C253	4030017730	S.CER ECJ0EB1E471K	B	144.7/48.3	
C254	4030017730	S.CER ECJ0EB1E471K	B	144.4/46.4	
C255	4030017490	S.CER C1608 JB 1A 105K-T	T	147.1/51	
C256	4030017490	S.CER C1608 JB 1A 105K-T	B	134.1/45.7	
C301	4030017780	S.CER ECJ0EB1E472K	T	108.3/19.9	
C302	4030017780	S.CER ECJ0EB1E472K	T	108.2/28.7	
C303	4030006880	S.CER C1608 JB 1H 472K-T	T	113/27	
C304	4030017780	S.CER ECJ0EB1E472K	B	113.2/33.8	
C305	4030017780	S.CER ECJ0EB1E472K	T	114.9/12.6	
C306	4030017780	S.CER ECJ0EB1E472K	B	113.8/4.3	
C312	4030017780	S.CER ECJ0EB1E472K	T	108.2/29.6	
C315	4030017780	S.CER ECJ0EB1E472K	B	25.2/19.9	
C316	4030017780	S.CER ECJ0EB1E472K	B	26.1/19.9	
C317	4030017780	S.CER ECJ0EB1E472K	B	27/19.9	
C318	4030017780	S.CER ECJ0EB1E472K	B	23.9/19.8	
C319	4030017780	S.CER ECJ0EB1E472K	B	27.2/32.5	
C320	4030017780	S.CER ECJ0EB1E472K	B	26.3/32.5	
C321	4030017780	S.CER ECJ0EB1E472K	B	25.5/31.1	
C322	4030017780	S.CER ECJ0EB1E472K	T	24.6/27.3	
C501	4550007140	S.TAN TEESVD 1C 107M12R	B	53.3/20.9	
C502	4550007140	S.TAN TEESVD 1C 107M12R	B	45.3/20.9	
C513	4030016930	S.CER ECJ0EB1A104K	B	64.3/47.4	
C514	4030016930	S.CER ECJ0EB1A104K	B	63.3/47.4	
C515	4030017490	S.CER C1608 JB 1A 105K-T	B	61.5/44.9	
C516	4030018910	S.CER C1608 JB 0J 475K-T	B	67.7/48.9	
C517	4030017490	S.CER C1608 JB 1A 105K-T	B	75.6/47.9	
C518	4030017650	S.CER ECJ0EC1H270J	[EUR] [FRA] [ESP] [USA] [XPR] [ITR] [UK] [KOR] [AUS] [CHN]	B	73.4/47.4
C519	4030016930	S.CER ECJ0EB1A104K	B	76.9/48.4	
C520	4030016930	S.CER ECJ0EB1A104K	B	74.4/47.4	
C521	4030018960	S.CER C3216 JB 1C 106MT-N	B	65.6/20.6	
C522	4030016930	S.CER ECJ0EB1A104K	B	69.7/19.8	
C523	4030018970	S.CER C3225 JB 1C 226MT-N	B	53.4/28.9	
C524	4030017700	S.CER ECJ0EC1H151J	B	59/42.6	
C525	4030016930	S.CER ECJ0EB1A104K	B	55.4/30.3	
C526	4030018090	S.CER ECJ0EB1C822K	B	59.2/35.8	
C527	4030018100	S.CER ECJ0EB1H681K	B	59/45.9	
C528	4030017730	S.CER ECJ0EB1E471K	B	59/45	
C529	4030018970	S.CER C3225 JB 1C 226MT-N	B	58.4/40	
C530	4030016930	S.CER ECJ0EB1A104K	B	77.2/39.1	
C531	4030018970	S.CER C3225 JB 1C 226MT-N	B	81.3/35.9	
C532	4030016930	S.CER ECJ0EB1A104K	B	77.2/36.6	
C533	4030017490	S.CER C1608 JB 1A 105K-T	B	77/44.5	
C534	4030016970	S.CER ECJ0EB1C223K	B	77.5/42.5	
C536	4610001850	S.TRI TZB4R200AB10R00 (TZBX4R200BA110)	B	81/39.7	
C537	4030016930	S.CER ECJ0EB1A104K	B	77.2/40.1	
C538	4030016930	S.CER ECJ0EB1A104K	B	77.2/37.6	
C539	4030018910	S.CER C1608 JB 0J 475K-T	B	77.7/34.9	
C540	4030018910	S.CER C1608 JB 0J 475K-T	B	58.5/37	
C541	4030018970	S.CER C3225 JB 1C 226MT-N	B	59.2/28.9	
C542	4030018910	S.CER C1608 JB 0J 475K-T	B	77.7/33.6	
C543	4030018960	S.CER C3216 JB 1C 106MT-N	B	80/46.5	
C544	4030018910	S.CER C1608 JB 0J 475K-T	B	77.7/32.3	
C545	4030011600	S.CER C1608 JB 1E 104K-T	B	77/46.3	
C549	4030018960	S.CER C3216 JB 1C 106MT-N	B	71.7/28.8	
C550	4030018960	S.CER C3216 JB 1C 106MT-N	B	77/28.8	
C551	4030018960	S.CER C3216 JB 1C 106MT-N	B	73.8/28.8	
C559	4030017460	S.CER ECJ0EB1E102K	B	29.3/43.9	
C560	4030018960	S.CER C3216 JB 1C 106MT-N	B	17/33.2	
C561	4030017330	S.CER ECJ0EF1C104Z	B	7.3/30.7	
C562	4030017780	S.CER ECJ0EB1E472K	B	6.1/30.9	
C601	4030016930	S.CER ECJ0EB1A104K	B	73.6/24.9	
C602	4030016930	S.CER ECJ0EB1A104K	B	48.8/43.5	
C603	4030016930	S.CER ECJ0EB1A104K	B	55/39.4	
C604	4030018960	S.CER C3216 JB 1C 106MT-N	B	55.8/36.3	
C605	4030016930	S.CER ECJ0EB1A104K	B	50.9/48	
C606	4030018960	S.CER C3216 JB 1C 106MT-N	B	49/47.4	
C607	4030011600	S.CER C1608 JB 1E 104K-T	B	55.4/40.6	
C608	4030018960	S.CER C3216 JB 1C 106MT-N	B	55.8/43.7	
C609	4030011600	S.CER C1608 JB 1E 104K-T	B	50.6/31	

[DISPLAY UNIT]

REF NO.	PARTS NO.	DESCRIPTION	M.	H/V LOCATION
C654	4030017490	S.CER C1608 JB 1A 105K-T	B	3.5/20.4
C655	4030016790	S.CER ECJ0EB1C103K	B	8.0/30.3
C656	4030019090	S.CER C2012 JB 1C 225M-T	B	7.8/25.5
C657	4030018520	S.CER C1608 JB 0J 225M-T	B	7/20.6
C658	4030017650	S.CER ECJ0EC1H270J	B	5.5/20.5
C659	4030017780	S.CER ECJ0EB1E472K	B	15.2/20.3
C701	4030018960	S.CER C3216 JB 1C 106MT-N	B	4.6/32.4
C702	4030018960	S.CER C3216 JB 1C 106MT-N	B	48.9/19
C801	4030016930	S.CER ECJ0EB1A104K	B	62.9/19.7
C802	4030011600	S.CER C1608 JB 1E 104K-T	B	21.5/48.5
C851	4030017780	S.CER ECJ0EB1E472K	B	32.1/23.9
C852	4030018960	S.CER C3216 JB 1C 106MT-N	B	40.3/15.8
C853	4030016930	S.CER ECJ0EB1A104K	B	43.1/27.5
C2001	4030018520	S.CER C1608 JB 0J 225M-T	B	78.5/16.7
C2002	4030017780	S.CER ECJ0EB1E472K	T	114.8/34.7
C2003	4030017630	S.CER ECJ0EC1H120J	B	103.3/28.7
C2004	4030017630	S.CER ECJ0EC1H120J	B	103.3/25.1
C2005	4030016790	S.CER ECJ0EB1C103K	B	103.2/34.9
C2006	4030016930	S.CER ECJ0EB1A104K	B	98/37.9
C2007	4030018960	S.CER C3216 JB 1C 106MT-N	B	105.8/47.7
C2008	4030017030	S.CER ECJ0EB1A273K	B	109.7/44.6
C2009	4030016930	S.CER ECJ0EB1A104K	B	99/37.9
C2010	4030016930	S.CER ECJ0EB1A104K	B	100/37.9
C2011	4030016930	S.CER ECJ0EB1A104K	B	78.7/29.9
C2012	4030017780	S.CER ECJ0EB1E472K	B	95.8/37.9
C2013	4030017780	S.CER ECJ0EB1E472K	T	93/37.9
C2014	4030016930	S.CER ECJ0EB1A104K	T	110.4/41.7
C2015	4030016930	S.CER ECJ0EB1A104K	B	103.1/35.8
C2016	4030016930	S.CER ECJ0EB1A104K	B	82.7/28.4
J202	6510023801	S.CON S4B-ZR-SM4A-TF(LF)(SN)	B	115.9/39.4
J251	6510025770	S.CON 03-935H0-72BKA	B	154.2/45.8
J303	6510021431	S.CON S8B-ZR-SM4A-TF(LF)(SN)	B	115.9/20.9
J401	6510024840	S.CON 52746-1070	B	21.3/26.3
J601	6510024780	S.CON 52437-2472	B	45.1/42
J2001	6510024790	S.CON 52559-1072	B	96.9/47.6
DS805	5040003190	S.LED NSSW008B	T	29.5/39.4
DS806	5040003190	S.LED NSSW008B	T	29.4/31.4
DS807	5040003190	S.LED NSSW008B	T	29.4/24.1
DS808	5040003190	S.LED NSSW008B	T	29.5/16.1
DS2001	5040002930	S.LED SML-512MW T86	T	110.2/15.8
DS2002	5040002020	S.LED CL-170UR-CD-T 0	T	110.2/36.8
DS2004	5040002930	S.LED SML-512MW T86	T	11.4/20.5
S201	2230001160	S.SWI SPVP110100	T	157.4/34.3
S251	2220000330	S.SWI HSW0880-01-210	B	139.7/46.5
S701	2230001150	S.SWI LS9J2M-1FG-T	T	22.2/48.3
S702	2230001150	S.SWI LS9J2M-1FG-T	T	21.7/36.5
S703	2230001150	S.SWI LS9J2M-1FG-T	T	20.9/17
S704	2230001150	S.SWI LS9J2M-1FG-T	T	21.6/2.7
S721	2230001150	S.SWI LS9J2M-1FG-T	T	40.1/2.4
S722	2230001150	S.SWI LS9J2M-1FG-T	T	54.3/2.4
S723	2230001150	S.SWI LS9J2M-1FG-T	T	68.4/2.4
S724	2230001150	S.SWI LS9J2M-1FG-T	T	82.6/2.4
S741	2230001150	S.SWI LS9J2M-1FG-T	T	98.1/47.8
S742	2230001150	S.SWI LS9J2M-1FG-T	T	99.1/32.1
S743	2230001150	S.SWI LS9J2M-1FG-T	T	99.1/20.5
S744	2230001150	S.SWI LS9J2M-1FG-T	T	98.1/5.7
S761	2230001150	S.SWI LS9J2M-1FG-T	T	109.5/49.1
S762	2230001150	S.SWI LS9J2M-1FG-T	T	109.5/3.5
S763	2230001150	S.SWI LS9J2M-1FG-T	T	154.8/47.4
S764	2230001150	S.SWI LS9J2M-1FG-T	T	154.8/5.1
S781	2230001150	S.SWI LS9J2M-1FG-T	T	4.6/29
S782	2230001150	S.SWI LS9J2M-1FG-T	T	21.7/25.8
EP1	6910014730	S.BEA MPZ2012S331A-T	B	64.1/6.6

[VR UNIT]

REF NO.	PARTS NO.	DESCRIPTION	M.	H/V LOCATION
R1	7210003230	VAR TP96D00A-17F-10K BX2-2427		
R2	7030003860	S.RES ERJ3GE JPW V	T	1.3/32.6
R3	7030003860	S.RES ERJ3GE JPW V	T	2.3/30
J1	6510024850	S.CON 54550-1094	T	3.3/22.2
S1	2250000170	ENC TP90D96AE20-17F (1352)		
EP4	6910012350	S.BEA MMZ1608Y 102BT	T	2.7/32.6
EP5	6910012350	S.BEA MMZ1608Y 102BT	T	3.7/30
EP6	6910012350	S.BEA MMZ1608Y 102BT	T	.9/30
EP7	6910012350	S.BEA MMZ1608Y 102BT	T	.9/14.5
EP8	6910012350	S.BEA MMZ1608Y 102BT	T	3.7/14.5
EP9	6910012350	S.BEA MMZ1608Y 102BT	T	2.7/11.8
EP10	6910012350	S.BEA MMZ1608Y 102BT	T	2.3/14.5
EP11	6910012350	S.BEA MMZ1608Y 102BT	T	1.3/11.8

M.=Mounted side (T: Mounted on the Top side, B: Mounted on the Bottom side)
S.=Surface mount

[LOGIC UNIT]

REF NO.	PARTS NO.	DESCRIPTION	M.	H/V LOCATION
IC1	1130013281	S.IC TC58FVM6T5BTG65GCH (SX2427D-6)	T	27.9/30.2
IC2	1130011151	S.IC SN74AHC2G08HDC3 0	B	40.2/38.2
IC3	1130011151	S.IC SN74AHC2G08HDC3 0	B	40.6/32.4
IC4	1130012600	S.IC SN74AHC1G04DCKR	B	43.6/33.8
IC51	1130012842	S.IC CY7C1021DV33-10BVXIT	B	24.5/28.5
IC301	1140012541	S.IC ADSP-BF532SBBBCZ400	B	28.6/39.2
IC401	1110004770	S.IC BU9480F-E2	B	17.4/21.6
IC451	1110006570	S.IC TS462CPT	B	29.1/7.9
IC452	1110006570	S.IC TS462CPT	T	39.1/8.5
IC502	1110006570	S.IC TS462CPT	T	30.7/5.4
IC551	1190001611	S.IC AK4528VFP-E2/P	T	17.9/8.1
IC601	1110006570	S.IC TS462CPT	B	12.7/10.8
IC701	1130012600	S.IC SN74AHC1G04DCKR	B	2.7/15.9
IC1201	1130012792	S.IC CY22150KFZXCCT	B	44.5/4.5
IC1212	1140012170	S.IC BH7236AF-E2	T	57.7/7.3
IC1217	1130007181	S.IC TC7WU04FU(TE12L,F)	B	63.4/9.8
IC1218	1130012761	S.IC SN74AHC2G86HDC3 0	B	52.7/6.5
IC1226	1130010871	S.IC S1D13706F00A200	B	53.7/19.8
IC1251	1180002020	S.REG BA033FP-E2	T	79.5/5.2
IC1301	1130012691	S.IC R1EX24256ASA00A	T	81.4/36.2
IC1302	1140013137	S.IC HD6432375A23FQV(SX-2427B-7)	T	54.9/25.2
IC1303	1110005771	S.IC S-80942CNMC-G9C2G	T	81.2/10.4
IC1304	1130011551	S.IC RX-4581NB-F	B	71.9/7.2
IC1402	1130012781	S.IC SN74AHC2G04HDC3 0	T	79.1/18.9
IC2002	1130012842	S.IC CY7C1021DV33-10BVXIT	B	32.7/28.3
IC2101	1130012850	S.IC SN74LVC3G34DCUR	T	44.5/44.7
IC2102	1130012850	S.IC SN74LVC3G34DCUR	T	44.4/41.2
IC2201	1140012541	S.IC ADSP-BF532SBBBCZ400	B	28.6/17.7
Q201	1550000110	S.FET RTQ035P02TR	B	18.9/42.7
Q1101	1530002060	S.TRA 2SC4081 T106 R	T	82.1/20.3
Q1102	1590003940	S.TRA RN1105(TE85L,F)	T	81.8/22.7
Q1103	1510000510	S.TRA 2SA1576A T106R	T	81.8/16.4
Q1201	1590003940	S.TRA RN1105(TE85L,F)	T	44.8/13.2
D201	1750001280	S.DIO CUS02(TE85L,Q)	B	19.2/45.3
D1001	1750000370	S.DIO DA221 TL	B	64.5/36.8
D1002	1750000370	S.DIO DA221 TL	B	64.9/34.5
D1101	1790001250	S.DIO MA2S111-(TX)	T	81.9/18.4
D1106	1750000950	S.DIO MA732(TX)	T	80.1/29.6
D1107	1790001670	S.DIO RB706F-40T106	T	82.4/31.3
D1110	1790001670	S.DIO RB706F-40T106	T	75.7/32.3
D1111	1790001670	S.DIO RB706F-40T106	T	75.3/29.3
D1112	1790001670	S.DIO RB706F-40T106	B	79.2/29.1
D1113	1790001670	S.DIO RB706F-40T106	B	82.3/30.6
D1201	1790001250	S.DIO MA2S111-(TX)	B	83/40.4
D1301	1790000660	S.DIO MA728(TX)	B	77.5/2.9
D1304	1750000370	S.DIO DA221 TL	T	76.1/19.9
D1305	1750000370	S.DIO DA221 TL	T	75.8/16.8
D1306	1750000370	S.DIO DA221 TL	B	49.3/32.9
D1307	1750000370	S.DIO DA221 TL	B	51.4/33.3
D1311	1790001250	S.DIO MA2S111-(TX)	B	80.9/19.6
D1312	1790001250	S.DIO MA2S111-(TX)	B	83.1/18.5
D1313	1790001250	S.DIO MA2S111-(TX)	B	80/22.6
D1314	1790001240	S.DIO MA2S728-(TX)	B	81.7/22.4
D1331	1790001250	S.DIO MA2S111-(TX)	B	65.6/17.5
X1201	6050012150	S.XTA CR-806 SMD-49TA 4.433619 MHz [EUR]	B	61.3/3.1
	6050012150	S.XTA CR-806 SMD-49TA 4.433619 MHz [FRA]		
	6050012150	S.XTA CR-806 SMD-49TA 4.433619 MHz [ESP]		
	6050012140	S.XTA CR-805 SMD-49TA 3.579545 MHz [USA]		
	6050012150	S.XTA CR-806 SMD-49TA 4.433619 MHz [EXP]		
	6050012150	S.XTA CR-806 SMD-49TA 4.433619 MHz [ITR]		
	6050012150	S.XTA CR-806 SMD-49TA 4.433619 MHz [UK]		
	6050012140	S.XTA CR-805 SMD-49TA 3.579545 MHz [KOR]		
	6050012150	S.XTA CR-806 SMD-49TA 4.433619 MHz [AUS]		
	6050012150	S.XTA CR-806 SMD-49TA 4.433619 MHz [CHN]		
X1301	6050012190	S.XTA CR-809 SMD-49TA 1539744 MHz	B	60.4/30.8
L201	6200011900	S.COI LQH43CN100K03L	T	16/41.9
L202	6200009491	S.COI CDRH6D28NP-100NC	B	13.3/42.3
L551	6200005011	S.COI NLV25T-100J	T	11.2/10.5
L552	6200005011	S.COI NLV25T-100J	T	11.1/5.8
L1202	6200002041	S.COI NLV25T-101J	B	52.3/2.3
L1203	6200002041	S.COI NLV25T-101J	T	66.7/3.5
L1204	6200002041	S.COI NLV25T-101J	B	57.9/10.3
L2101	6200005011	S.COI NLV25T-100J	T	40.9/4.5
L2102	6200005011	S.COI NLV25T-100J	T	40.2/41.5
R2	7030005090	S.RES ERJ2GEJ 104 X (100K)	T	39.5/30.1
R3	7030005090	S.RES ERJ2GEJ 104 X (100K)	T	39.5/32.4
R4	7030005090	S.RES ERJ2GEJ 104 X (100K)	T	31.8/45.8
R5	7030005090	S.RES ERJ2GEJ 104 X (100K)	T	30.9/45.8

[LOGIC UNIT]

REF NO.	PARTS NO.	DESCRIPTION	M.	H/V LOCATION
R6	7030005090	S.RES ERJ2GEJ 104 X (100K)	T	30/45.8
R203	7030000010	S.RES MCR10EZHJ JPW (000)	T	20.7/45.6
R301	7030004980	S.RES ERJ2GEJ 101 X (100)	T	25.4/45.8
R302	7030005050	S.RES ERJ2GEJ 103 X (10K)	T	26.9/45.8
R303	7030005050	S.RES ERJ2GEJ 103 X (10K)	T	27.8/45.8
R306	7030005050	S.RES ERJ2GEJ 103 X (10K)	B	38.1/31.1
R307	7030005050	S.RES ERJ2GEJ 103 X (10K)	T	22/41.4
R308	7030005050	S.RES ERJ2GEJ 103 X (10K)	T	22/40.5
R310	7030005050	S.RES ERJ2GEJ 103 X (10K)	B	35.3/38
R312	7030010040	S.RES ERJ2GEJ-JPW	B	33.6/45.9
R313	7030010040	S.RES ERJ2GEJ-JPW	B	35.6/43.3
R314	7030010040	S.RES ERJ2GEJ-JPW	B	35.6/40.6
R413	7030004980	S.RES ERJ2GEJ 101 X (100)	B	18.1/16.8
R414	7030004980	S.RES ERJ2GEJ 101 X (100)	T	16.3/19.9
R415	7030004980	S.RES ERJ2GEJ 101 X (100)	B	19/16.8
R416	7030004980	S.RES ERJ2GEJ 101 X (100)	B	17.2/16.8
R462	7030004980	S.RES ERJ2GEJ 101 X (100)	B	33.8/7.4
R463	7030004980	S.RES ERJ2GEJ 101 X (100)	T	43.6/8.8
R464	7030004980	S.RES ERJ2GEJ 101 X (100)	B	26.2/5.7
R465	7030009270	S.RES ERJ2GEJ 821 X (820)	B	28.6/5.2
R467	7030004980	S.RES ERJ2GEJ 101 X (100)	B	31.3/4.3
R469	7030009270	S.RES ERJ2GEJ 821 X (820)	B	30.4/4.3
R470	7030009140	S.RES ERJ2GEJ 272 X (2.7K)	T	29/3.3
R471	7030009140	S.RES ERJ2GEJ 272 X (2.7K)	T	34/3.3
R472	7030005040	S.RES ERJ2GEJ 472 X (4.7K)	T	38.6/4.2
R473	7030005040	S.RES ERJ2GEJ 472 X (4.7K)	T	38.6/3.2
R474	7030009140	S.RES ERJ2GEJ 272 X (2.7K)	B	24.8/7.1
R475	7030009140	S.RES ERJ2GEJ 272 X (2.7K)	B	33.8/9.2
R476	7030005040	S.RES ERJ2GEJ 472 X (4.7K)	T	40.2/3.3
R507	7030004980	S.RES ERJ2GEJ 101 X (100)	T	26/3.5
R508	7030004980	S.RES ERJ2GEJ 101 X (100)	T	31.6/8.9
R510	7030005040	S.RES ERJ2GEJ 472 X (4.7K)	T	32.5/8.9
R511	7030005040	S.RES ERJ2GEJ 472 X (4.7K)	T	28.9/8.9
R512	7030004980	S.RES ERJ2GEJ 101 X (100)	T	29.8/8.9
R514	7030005050	S.RES ERJ2GEJ 103 X (10K)	T	34.9/8.8
R515	7030005050	S.RES ERJ2GEJ 103 X (10K)	T	34.9/7.9
R516	7030005040	S.RES ERJ2GEJ 472 X (4.7K)	T	39/12.8
R517	7030005040	S.RES ERJ2GEJ 472 X (4.7K)	T	36.5/11
R518	7030009140	S.RES ERJ2GEJ 272 X (2.7K)	T	36.4/5.6
R519	7030009140	S.RES ERJ2GEJ 272 X (2.7K)	T	26.4/5.6
R520	7030005040	S.RES ERJ2GEJ 472 X (4.7K)	T	41.3/12.8
R551	7030004980	S.RES ERJ2GEJ 101 X (100)	T	16.5/13.4
R553	7030004980	S.RES ERJ2GEJ 101 X (100)	T	14.7/13.4
R554	7030005090	S.RES ERJ2GEJ 104 X (100K)	T	15.4/3.2
R568	7030004980	S.RES ERJ2GEJ 101 X (100)	T	12.9/13.4
R569	7030004980	S.RES ERJ2GEJ 101 X (100)	T	15.6/13.4
R570	7030004980	S.RES ERJ2GEJ 101 X (100)	T	13.8/13.4
R571	7030009320	S.RES ERJ2GEJ 4R7 X (4.7)	B	20.7/8.4
R601	7030004980	S.RES ERJ2GEJ 101 X (100)	T	3/12.3
R602	7030007300	S.RES ERJ2GEJ 332 X (3.3K)	T	11.8/8.4
R603	7030005040	S.RES ERJ2GEJ 472 X (4.7K)	B	12.3/4.8
R604	7030005040	S.RES ERJ2GEJ 472 X (4.7K)	B	13.2/4.8
R605	7030007300	S.RES ERJ2GEJ 332 X (3.3K)	B	14.4/5.1
R606	7030007300	S.RES ERJ2GEJ 332 X (3.3K)	B	12.8/7.2
R607	7030005290	S.RES ERJ2GEJ 682 X (6.8K)	B	13.8/7.2
R608	7030005290	S.RES ERJ2GEJ 682 X (6.8K)	B	14.8/6.4
R609	7030005040	S.RES ERJ2GEJ 472 X (4.7K)	T	10.9/8.4
R610	7030005040	S.RES ERJ2GEJ 472 X (4.7K)	B	8.9/4.2
R611	7030005040	S.RES ERJ2GEJ 472 X (4.7K)	B	9.8/4.2
R612	7030007300	S.RES ERJ2GEJ 332 X (3.3K)	B	11.4/5.6
R613	7030007300	S.RES ERJ2GEJ 332 X (3.3K)	B	8.8/6.9
R614	7030005290	S.RES ERJ2GEJ 682 X (6.8K)	B	9.7/6.9
R615	7030005290	S.RES ERJ2GEJ 682 X (6.8K)	B	10.6/6.9
R618	7030005120	S.RES ERJ2GEJ 102 X (1K)	B	14.4/4.2
R619	7030005120	S.RES ERJ2GEJ 102 X (1K)	B	10.7/4.2
R701	7030005050	S.RES ERJ2GEJ 103 X (10K)	B	4.6/22.8
R702	7030005050	S.RES ERJ2GEJ 103 X (10K)	B	4.6/23.7
R703	7030005050	S.RES ERJ2GEJ 103 X (10K)	B	4.5/25.9
R705	7030005120	S.RES ERJ2GEJ 102 X (1K)	B	5/21
R706	7030005050	S.RES ERJ2GEJ 103 X (10K)	B	4.4/17.1
R707	7030007250	S.RES ERJ2GEJ 220 X (22)	B	4.4/15.5
R1001	7030005120	S.RES ERJ2GEJ 102 X (1K)	B	70.8/37
R1002	7030005050	S.RES ERJ2GEJ 103 X (10K)	B	65.9/32.3
R1003	7030005160	S.RES ERJ2GEJ 105 X (1M)	B	70.4/35.8
R1004	7030005240	S.RES ERJ2GEJ 473 X (47K)	B	66.1/18.5
R1006	7030005120	S.RES ERJ2GEJ 102 X (1K)	B	52/34.8
R1007	7030005120	S.RES ERJ2GEJ 102 X (1K)	B	53.2/32
R1008	7030005120	S.RES ERJ2GEJ 102 X (1K)	B	75.1/20.4
R1010	7030005240	S.RES ERJ2GEJ 473 X (47K)	B	76.7/19.8
R1012	7030005000	S.RES ERJ2GEJ 471 X (470)	B	66.5/33.9
R1013	7030005000	S.RES ERJ2GEJ 471 X (470)	B	66.5/36.4
R1015	7030005240	S.RES ERJ2GEJ 473 X (47K)	B	50.4/34.8
R1016	7030005240	S.RES ERJ2GEJ 473 X (47K)	B	51/31.7
R1018	7030007340	S.RES ERJ2GEJ 153 X (15K)	B	63.3/34.4
R1019	7030007340	S.RES ERJ2GEJ 153 X (15K)	B	62.9/36.1
R1101	7030008290	S.RES ERJ2GEJ 183 X (18K)	T	80.1/15.4
R1102	7030008010	S.RES ERJ2GEJ 123 X (12K)	T	79.9/21.9
R1103	7030005120	S.RES ERJ2GEJ 102 X (1K)	T	79.9/22.8
R1104	7030005120	S.RES ERJ2		

[LOGIC UNIT]

REF NO.	PARTS NO.	DESCRIPTION	M.	H/V LOCATION
R1116	7030005120	S.RES ERJ2GEJ 102 X (1K)	T	76.9/28.1
R1117	7030005120	S.RES ERJ2GEJ 102 X (1K)	B	82.7/22.2
R1118	7030007300	S.RES ERJ2GEJ 332 X (3.3K)	B	83/23.8
R1119	7030007300	S.RES ERJ2GEJ 332 X (3.3K)	B	83.8/22.2
R1120	7030005120	S.RES ERJ2GEJ 102 X (1K)	B	84.1/23.8
R1123	7030005160	S.RES ERJ2GEJ 105 X (1M)	B	66.9/24.4
R1124	7030005120	S.RES ERJ2GEJ 102 X (1K)	B	82/20
R1126	7030005160	S.RES ERJ2GEJ 105 X (1M)	B	66.9/23.5
R1127	7030010040	S.RES ERJ2GEJ-JPW	T	73.7/18.5
R1128	7030005120	S.RES ERJ2GEJ 102 X (1K)	B	83.2/20.1
R1129	7030007300	S.RES ERJ2GEJ 332 X (3.3K)	B	81.9/28.4
R1131	7030005090	S.RES ERJ2GEJ 104 X (100K)	B	78.5/26.1
R1132	7030005090	S.RES ERJ2GEJ 104 X (100K)	B	81.4/24.4
R1201	7030005160	S.RES ERJ2GEJ 105 X (1M)	B	62.7/7.6
R1202	7030005050	S.RES ERJ2GEJ 103 X (10K)	B	49.2/7.5
R1203	7030005050	S.RES ERJ2GEJ 103 X (10K)	B	49.2/8.4
R1204	7030005050	S.RES ERJ2GEJ 103 X (10K)	B	49.7/9.6
R1205	7030010040	S.RES ERJ2GEJ-JPW	B	49.2/3.1
R1206	7030007570	S.RES ERJ2GEJ 122 X (1.2K)	B	46.1/9.6
R1207	7030007570	S.RES ERJ2GEJ 122 X (1.2K)	B	43.9/9.6
R1208	7030007570	S.RES ERJ2GEJ 122 X (1.2K)	B	43.5/11.4
R1209	7030009710	S.RES ERJ2GEJ 203 X (20K)	B	48.8/9.6
R1210	7030007350	S.RES ERJ2GEJ 393 X (39K)	B	47.9/9.6
R1211	7030005050	S.RES ERJ2GEJ 103 X (10K)	B	48.9/11.4
R1212	7030005050	S.RES ERJ2GEJ 103 X (10K)	B	48/11.4
R1213	7030005050	S.RES ERJ2GEJ 103 X (10K)	B	47.1/11.4
R1214	7030009710	S.RES ERJ2GEJ 203 X (20K)	B	46.2/11.4
R1215	7030007350	S.RES ERJ2GEJ 393 X (39K)	B	45.3/11.4
R1216	7030005050	S.RES ERJ2GEJ 103 X (10K)	B	44.7/12.6
R1217	7030005050	S.RES ERJ2GEJ 103 X (10K)	B	44.7/13.5
R1218	7030005050	S.RES ERJ2GEJ 103 X (10K)	B	44.7/14.4
R1219	7030005040	S.RES ERJ2GEJ 472 X (4.7K)	B	74.4/41.1
R1220	7030009710	S.RES ERJ2GEJ 203 X (20K)	B	44.7/15.3
R1221	7030005040	S.RES ERJ2GEJ 472 X (4.7K)	B	79.9/41.6
R1222	7030005040	S.RES ERJ2GEJ 472 X (4.7K)	B	82.4/40.2
R1223	7030005040	S.RES ERJ2GEJ 472 X (4.7K)	B	74.4/39.3
R1224	7030005040	S.RES ERJ2GEJ 472 X (4.7K)	B	82.9/39.3
R1225	7030005240	S.RES ERJ2GEJ 473 X (47K)	B	83.1/35.7
R1226	7030005240	S.RES ERJ2GEJ 473 X (47K)	B	74.4/37.5
R1227	7030005240	S.RES ERJ2GEJ 473 X (47K)	B	73.8/38.4
R1228	7030005240	S.RES ERJ2GEJ 473 X (47K)	B	82.2/35.7
R1229	7030007350	S.RES ERJ2GEJ 393 X (39K)	B	43.5/15.4
R1230	7030004970	S.RES ERJ2GEJ 470 X (47)	B	49.2/2.2
R1231	7030005050	S.RES ERJ2GEJ 103 X (10K)	B	48.8/5.4
R1232	7030005220	S.RES ERJ2GEJ 223 X (22K)	B	40.3/3.2
R1235	7030007270	S.RES ERJ2GEJ 151 X (150)	T	66.2/5.9
R1236	7030007270	S.RES ERJ2GEJ 151 X (150)	T	66.2/7
R1237	7030007290	S.RES ERJ2GEJ 222 X (2.2K)	B	61.1/7.6
R1251	7030011250	S.RES ERJ1TY 390U (39)	T	70.3/6.4
R1301	7030005220	S.RES ERJ2GEJ 223 X (22K)	T	78.1/37.8
R1302	7030005050	S.RES ERJ2GEJ 103 X (10K)	T	78.1/36
R1303	7030005240	S.RES ERJ2GEJ 473 X (47K)	B	66/21.2
R1304	7030005240	S.RES ERJ2GEJ 473 X (47K)	B	66/20.3
R1305	7030009160	S.RES ERJ2GEJ 181 X (180)	T	68.5/25.9
R1306	7030005060	S.RES ERJ2GEJ 333 X (33K)	T	78.7/11.4
R1307	7030005040	S.RES ERJ2GEJ 472 X (4.7K)	B	68/21.9
R1308	7030005110	S.RES ERJ2GEJ 224 X (220K)	T	67.5/20
R1309	7030005110	S.RES ERJ2GEJ 224 X (220K)	T	69/19.4
R1310	7030005110	S.RES ERJ2GEJ 224 X (220K)	T	67.5/18.8
R1311	7030005110	S.RES ERJ2GEJ 224 X (220K)	T	69/18.2
R1312	7030005110	S.RES ERJ2GEJ 224 X (220K)	T	67.5/17.6
R1313	7030005110	S.RES ERJ2GEJ 224 X (220K)	T	69/17
R1314	7030005110	S.RES ERJ2GEJ 224 X (220K)	T	67.5/16.4
R1315	7030005110	S.RES ERJ2GEJ 224 X (220K)	T	69/15.8
R1316	7030005110	S.RES ERJ2GEJ 224 X (220K)	B	66.6/12.3
R1317	7030005110	S.RES ERJ2GEJ 224 X (220K)	B	65.7/12.3
R1318	7030005110	S.RES ERJ2GEJ 224 X (220K)	B	64.8/12.3
R1319	7030005110	S.RES ERJ2GEJ 224 X (220K)	B	63.9/12.3
R1320	7030005110	S.RES ERJ2GEJ 224 X (220K)	B	63/12.3
R1321	7030005110	S.RES ERJ2GEJ 224 X (220K)	B	62.1/12.3
R1322	7030005110	S.RES ERJ2GEJ 224 X (220K)	B	61.2/12.3
R1323	7030005110	S.RES ERJ2GEJ 224 X (220K)	B	60.3/12.1
R1324	7030005050	S.RES ERJ2GEJ 103 X (10K)	T	80.5/12.6
R1325	7030007350	S.RES ERJ2GEJ 393 X (39K)	T	78.1/9.8
R1326	7030005010	S.RES ERJ2GEJ 681 X (680)	B	78.9/2
R1327	7030005240	S.RES ERJ2GEJ 473 X (47K)	B	66/19.4
R1328	7030005050	S.RES ERJ2GEJ 103 X (10K)	B	75.9/6.4
R1329	7030005240	S.RES ERJ2GEJ 473 X (47K)	B	75.9/5
R1331	7030010040	S.RES ERJ2GEJ-JPW	B	75.9/3.2
R1332	7030005040	S.RES ERJ2GEJ 472 X (4.7K)	B	75.9/4.1
R1333	7030005110	S.RES ERJ2GEJ 224 X (220K)	B	67.4/26.9
R1334	7030005050	S.RES ERJ2GEJ 103 X (10K)	T	78.3/12.6
R1335	7030010040	S.RES ERJ2GEJ-JPW	T	78.5/5.1
R1337	7030005240	S.RES ERJ2GEJ 473 X (47K)	B	40.9/15.5
R1338	7030005240	S.RES ERJ2GEJ 473 X (47K)	T	40.9/16.4
R1339	7030007290	S.RES ERJ2GEJ 222 X (2.2K)	B	65.5/22.4
R1401	7030005240	S.RES ERJ2GEJ 473 X (47K)	B	62.7/24.2
R1402	7030005240	S.RES ERJ2GEJ 473 X (47K)	B	76.7/21.8
R1403	7030005240	S.RES ERJ2GEJ 473 X (47K)	B	78.3/22.1
R1404	7030005240	S.RES ERJ2GEJ 473 X (47K)	B	76.7/22.9
R1405	7030005240	S.RES ERJ2GEJ 473 X (47K)	T	50.7/12.9
R1406	7030005240	S.RES ERJ2GEJ 473 X (47K)	T	69/20.6
R1407	7030005240	S.RES ERJ2GEJ 473 X (47K)	T	41.7/33.4
R1408	7030005240	S.RES ERJ2GEJ 473 X (47K)	B	76.7/25.3
R1409	7030005240	S.RES ERJ2GEJ 473 X (47K)	B	78.3/24.7
R1410	7030005240	S.RES ERJ2GEJ 473 X (47K)	B	78.3/23.5
R1411	7030005240	S.RES ERJ2GEJ 473 X (47K)	B	76.7/24.1
R1412	7030005240	S.RES ERJ2GEJ 473 X (47K)	B	43.6/24.7
R1413	7030005240	S.RES ERJ2GEJ 473 X (47K)	T	42.4/17.9

[LOGIC UNIT]

REF NO.	PARTS NO.	DESCRIPTION	M.	H/V LOCATION
R1502	7030007300	S.RES ERJ2GEJ 332 X (3.3K)	B	80.9/28.4
R2101	7030005050	S.RES ERJ2GEJ 103 X (10K)	T	48.1/44.9
R2102	7030005050	S.RES ERJ2GEJ 103 X (10K)	T	47.7/42.7
R2103	7030005050	S.RES ERJ2GEJ 103 X (10K)	T	47.6/40.5
R2104	7030005050	S.RES ERJ2GEJ 103 X (10K)	T	47.7/43.7
R2105	7030005050	S.RES ERJ2GEJ 103 X (10K)	T	47.5/41.7
R2110	7030010040	S.RES ERJ2GEJ-JPW	B	21.4/22.5
R2112	7030005040	S.RES ERJ2GEJ 472 X (4.7K)	T	38.5/44.4
R2201	7030004980	S.RES ERJ2GEJ 101 X (100)	T	31.5/11.1
R2202	7030005050	S.RES ERJ2GEJ 103 X (10K)	T	30.6/11.1
R2203	7030005050	S.RES ERJ2GEJ 103 X (10K)	T	21.5/22.4
R2204	7030005050	S.RES ERJ2GEJ 103 X (10K)	T	35.2/15.5
R2205	7030005050	S.RES ERJ2GEJ 103 X (10K)	T	35.2/16.4
R2206	7030005050	S.RES ERJ2GEJ 103 X (10K)	T	21.5/21.5
R2214	7030005050	S.RES ERJ2GEJ 103 X (10K)	T	27.5/11.1
R2215	7030005050	S.RES ERJ2GEJ 103 X (10K)	T	28.4/11.1
R2216	7030010040	S.RES ERJ2GEJ-JPW	T	34.8/37.3
C1	4030016930	S.CER ECJ0EB1A104K	T	16.9/25.1
C2	4030016930	S.CER ECJ0EB1A104K	B	38.1/36
C3	4030016930	S.CER ECJ0EB1A104K	B	39.5/28.9
C4	4030016930	S.CER ECJ0EB1A104K	B	42.4/35.8
C5	4550007310	S.TAN F930J227MNMBSMA	T	40.8/23.4
C51	4030016930	S.CER ECJ0EB1A104K	B	19.2/27.4
C52	4030016930	S.CER ECJ0EB1A104K	B	19.2/28.3
C53	4550007310	S.TAN F930J227MNMBSMA	B	11.4/30.3
C54	4550007310	S.TAN F930J227MNMBSMA	T	7.1/8
C201	4030016930	S.CER ECJ0EB1A104K	B	19/40.2
C203	4030018960	S.CER C3216 JB 1C 106MT-N	T	18.8/45.5
C204	4030016930	S.CER ECJ0EB1A104K	T	11.9/40.2
C205	4030016930	S.CER ECJ0EB1A104K	T	11.9/41.8
C206	4030016930	S.CER ECJ0EB1A104K	B	8.8/43.4
C207	4030019460	S.CER C1608 JB 0J 106M-T	T	9.9/45
C302	4030016930	S.CER ECJ0EB1A104K	T	30.2/40.4
C303	4030016930	S.CER ECJ0EB1A104K	T	30.4/37.8
C304	4030016930	S.CER ECJ0EB1A104K	T	26.9/37.2
C305	4030016930	S.CER ECJ0EB1A104K	T	34.1/45.8
C306	4030016930	S.CER ECJ0EB1A104K	T	29.2/37.2
C307	4030016930	S.CER ECJ0EB1A104K	B	38.3/35
C308	4030016930	S.CER ECJ0EB1A104K	T	27.3/39.3
C309	4030016930	S.CER ECJ0EB1A104K	T	30.6/39.1
C310	4030016930	S.CER ECJ0EB1A104K	T	24.5/45.8
C311	4030016930	S.CER ECJ0EB1A104K	T	22/42.3
C312	4030016930	S.CER ECJ0EB1A104K	T	27.8/40.5
C313	4030016930	S.CER ECJ0EB1A104K	T	22/39.6
C314	4030016930	S.CER ECJ0EB1A104K	T	29.1/45.8
C315	4030016930	S.CER ECJ0EB1A104K	T	27.3/38.4
C316	4030016930	S.CER ECJ0EB1A104K	T	30.4/36.9
C317	4030016930	S.CER ECJ0EB1A104K	T	26.9/40.5
C318	4030016930	S.CER ECJ0EB1A104K	T	31.1/40.4
C319	4030016930	S.CER ECJ0EB1A104K	T	29.3/40.4
C320	4030016930	S.CER ECJ0EB1A104K	T	27.8/37.2
C413	4030018960	S.CER C3216 JB 1C 106MT-N	B	21.3/19.6
C414	4030016930	S.CER ECJ0EB1A104K	B	16.3/16.8
C415	4030018960	S.CER C3216 JB 1C 106MT-N	B	15.6/26.3
C461	4030016930	S.CER ECJ0EB1A104K	B	34.2/4.3
C462	4030018960	S.CER C3216 JB 1C 106MT-N	B	35.3/5.8
C463	4030018960	S.CER C3216 JB 1C 106MT-N	T	42/8.7
C464	4030016930	S.CER ECJ0EB1A104K	T	43.6/10.4
C465	4030017740	S.CER ECJ0EB1E821K	B	27.4/5.5
C466	4030017760	S.CER ECJ0EB1H222K	B	29.5/4.3
C467	4030017740	S.CER ECJ0EB1E821K	B	30.7/5.5
C468	4030018560	S.CER C2012 JB 1A 475K-T	T	31.8/2.6
C469	4030016930	S.CER ECJ0EB1A104K	B	24.8/8.7
C470	4030016930	S.CER ECJ0EB1A104K	B	33.8/8.3
C471	4030018560	S.CER C2012 JB 1A 475K-T	T	36.2/4.2
C472	4030018560	S.CER C2012 JB 1A 475K-T	T	36.2/2.5
C473	4030016930	S.CER ECJ0EB1A104K	T	40.2/4.2
C509	4030018960	S.CER C3216 JB 1C 106MT-N	T	24.2/5.5
C510	4030016930	S.CER ECJ0EB1A104K	T	26/4.4
C511	4030017760	S.CER ECJ0EB1H222K	T	30.7/8.9
C512	4030017690	S.CER ECJ0EC1H121J	T	32.1/7.7
C513	4030017690	S.CER ECJ0EC1H121J	T	29.4/7.7
C514	4030016930	S.CER ECJ0EB1A104K	T	36.4/5.5
C515	4030018860	S.CER ECJ0EB0J105K	T	36.5/9.2
C516	4030018860	S.CER ECJ0EB0J105K	T	36.5/8.3
C517	4030018860	S.CER ECJ0EB0J105K	T	36.5/10.1
C518	4030016930	S.CER ECJ0EB1A104K	T	26.1/6.8
C519	4030016930	S.CER ECJ0EB1A104K	T	41.3/11.9
C522	4030017780	S.CER ECJ0EB1E472K	B	38.9/9.8
C523	4030017780	S.CER ECJ0EB1E472K	B	38/2.8
C524	4030017780	S.CER ECJ0EB1E472K	T	3.8/2.6
C525	4030017780	S.CER ECJ0EB1E472K	T	22.4/2.7
C526	4030017780	S.CER ECJ0EB1E472K	T	42.9/3.8
C527	4030017780	S.CER ECJ0EB1E472K	B	2

[LOGIC UNIT]

REF NO.	PARTS NO.	DESCRIPTION	M.	H/V LOCATION
C606	4030018580	S.CER C1608 CH 1H 821J-T	B	9.6/5.6
C607	4030017440	S.CER ECJ0EC1H221J	B	13.3/8.4
C608	4030017440	S.CER ECJ0EC1H221J	B	14.8/8
C609	4030018860	S.CER ECJ0EB0J105K	B	15.8/14.5
C610	4030010760	S.CER C1608 CH 1H 331J-T	B	9.6/8.3
C611	4030010760	S.CER C1608 CH 1H 331J-T	B	11.8/7.7
C612	4030018960	S.CER C3216 JB 1C 106MT-N	B	7.5/13.1
C613	4550006780	S.TAN TEESVB2 0J 476M8R	B	20.6/2.7
C614	4550006780	S.TAN TEESVB2 0J 476M8R	T	3.1/6.6
C651	4030017460	S.CER ECJ0EB1E102K	B	65.5/31.4
C652	4030017460	S.CER ECJ0EB1E102K	B	66/16.4
C653	4030017460	S.CER ECJ0EB1E102K	B	77.1/20.9
C654	4030017430	S.CER ECJ0EC1H101J	B	77.2/28.2
C655	4030017430	S.CER ECJ0EC1H101J	B	76.5/27.1
C656	4030017430	S.CER ECJ0EC1H101J	B	76.1/26.2
C701	4030016930	S.CER ECJ0EB1A104K	B	3/13.5
C702	4030017780	S.CER ECJ0EB1E472K	B	4.4/18.8
C703	4030017780	S.CER ECJ0EB1E472K	B	7.5/26.1
C704	4030017780	S.CER ECJ0EB1E472K	B	19.7/26.2
C705	4030017430	S.CER ECJ0EC1H101J	B	4.6/21.9
C706	4030017430	S.CER ECJ0EC1H101J	B	4.6/24.6
C707	4030017430	S.CER ECJ0EC1H101J	B	3.9/27.2
C708	4030017430	S.CER ECJ0EC1H101J	B	6.6/26.1
C709	4030017430	S.CER ECJ0EC1H101J	T	2.5/20.1
C711	4550007310	S.TAN F930J227MNMBA	T	5.5/18.9
C715	4030017460	S.CER ECJ0EB1E102K	T	2.2/17.6
C716	4030017460	S.CER ECJ0EB1E102K	T	2.2/18.6
C717	4030017460	S.CER ECJ0EB1E102K	T	2.2/16.6
C1001	4030017780	S.CER ECJ0EB1E472K	B	76.7/18.9
C1002	4030017780	S.CER ECJ0EB1E472K	B	70.4/38.2
C1101	4030017780	S.CER ECJ0EB1E472K	T	79.9/23.7
C1102	4030017780	S.CER ECJ0EB1E472K	T	73.6/20.7
C1103	4030016930	S.CER ECJ0EB1A104K	T	81.8/14.5
C1106	4030017780	S.CER ECJ0EB1E472K	T	79.7/31.9
C1107	4030018900	S.CER ECJ0EB0J474K	B	80.1/25.5
C1108	4030018900	S.CER ECJ0EB0J474K	B	81.4/25.4
C1109	4030017780	S.CER ECJ0EB1E472K	T	79.7/26.3
C1110	4030017780	S.CER ECJ0EB1E472K	T	80.7/26.3
C1111	4030017780	S.CER ECJ0EB1E472K	T	81.7/26.3
C1112	4030017780	S.CER ECJ0EB1E472K	B	82.9/28.4
C1201	4030016930	S.CER ECJ0EB1A104K	B	50.6/4.3
C1202	4030017780	S.CER ECJ0EB1E472K	B	53.2/4.3
C1203	4030017650	S.CER ECJ0EC1H270J	B	62.7/6.7
C1204	4030016930	S.CER ECJ0EB1A104K	B	47.9/8
C1205	4030016930	S.CER ECJ0EB1A104K	B	45.2/9.6
C1206	4030016930	S.CER ECJ0EB1A104K	B	43.5/13.8
C1207	4030017430	S.CER ECJ0EC1H101J	B	47/9.6
C1208	4030017430	S.CER ECJ0EC1H101J	B	43.9/8.7
C1209	4030017430	S.CER ECJ0EC1H101J	B	44.4/11.4
C1210	4030017650	S.CER ECJ0EC1H270J	B	61.1/6.7
C1211	4030018860	S.CER ECJ0EB0J105K	B	60.2/10.5
C1212	4030016930	S.CER ECJ0EB1A104K	B	49.7/4.3
C1213	4030016930	S.CER ECJ0EB1A104K	B	49.2/6.6
C1214	4030016930	S.CER ECJ0EB1A104K	B	40.3/4.8
C1215	4030016930	S.CER ECJ0EB1A104K	B	64.2/19.3
C1216	4030016930	S.CER ECJ0EB1A104K	B	53.7/30.3
C1217	4030016930	S.CER ECJ0EB1A104K	B	57.5/29.2
C1218	4030016930	S.CER ECJ0EB1A104K	B	44.8/23.9
C1219	4030016930	S.CER ECJ0EB1A104K	B	46.3/13.2
C1220	4030016930	S.CER ECJ0EB1A104K	B	56/8.8
C1221	4030016930	S.CER ECJ0EB1A104K	B	60.5/13.7
C1222	4030016930	S.CER ECJ0EB1A104K	B	60.9/25.6
C1223	4030016930	S.CER ECJ0EB1A104K	T	52.7/12.3
C1225	4030018960	S.CER C3216 JB 1C 106MT-N	T	66.7/10.2
C1251	4030012610	S.CER C2012 JB 1C 474K-T	T	73.4/9.3
C1252	4550007320	S.TAN F930J226MAABMA	T	73.4/4.4
C1301	4030016930	S.CER ECJ0EB1A104K	T	80.1/40.3
C1302	4030018960	S.CER C3216 JB 1C 106MT-N	T	47.9/11.4
C1303	4030016790	S.CER ECJ0EB1C103K	T	67.9/30.4
C1304	4030016930	S.CER ECJ0EB1A104K	T	41.7/31.5
C1305	4030018960	S.CER C3216 JB 1C 106MT-N	T	44.3/37.2
C1306	4030016790	S.CER ECJ0EB1C103K	T	64/37.5
C1307	4030016930	S.CER ECJ0EB1A104K	T	48.4/12.9
C1308	4030016930	S.CER ECJ0EB1A104K	T	63.1/13.1
C1309	4030016930	S.CER ECJ0EB1A104K	T	46.1/37.2
C1310	4030016930	S.CER ECJ0EB1A104K	T	67/30.9
C1311	4030016930	S.CER ECJ0EB1A104K	T	67/25.7
C1312	4030017620	S.CER ECJ0EC1H100C	T	67.4/29.1
C1313	4030017620	S.CER ECJ0EC1H100C	T	67.4/28.2
C1314	4030016930	S.CER ECJ0EB1A104K	T	79/9.8
C1315	4030017030	S.CER ECJ0EB1A273K	T	83.3/10.8
C1316	4030016930	S.CER ECJ0EB1A104K	B	75.9/2.3
C1317	4030018960	S.CER C3216 JB 1C 106MT-N	B	84.4/3
C1319	4030018960	S.CER C3216 JB 1C 106MT-N	B	16.8/6.6
C2016	4030016930	S.CER ECJ0EB1A104K	B	37.7/29.3
C2017	4030016930	S.CER ECJ0EB1A104K	B	37.7/30.2
C2101	4030016930	S.CER ECJ0EB1A104K	T	44/43
C2102	4030016930	S.CER ECJ0EB1A104K	T	45.8/43
C2202	4030016930	S.CER ECJ0EB1A104K	T	27/16.5
C2204	4030016930	S.CER ECJ0EB1A104K	T	26.5/19.2
C2205	4030016930	S.CER ECJ0EB1A104K	T	30.2/19.7
C2206	4030016930	S.CER ECJ0EB1A104K	T	26.6/11.1
C2207	4030016930	S.CER ECJ0EB1A104K	T	27.7/19.7
C2208	4030016930	S.CER ECJ0EB1A104K	T	21.5/23.4
C2209	4030016930	S.CER ECJ0EB1A104K	T	29.8/17.6
C2210	4030016930	S.CER ECJ0EB1A104K	T	26.6/17.8
C2211	4030016930	S.CER ECJ0EB1A104K	T	32.4/11.1
C2212	4030016930	S.CER ECJ0EB1A104K	T	35.2/14.6
C2213	4030016930	S.CER ECJ0EB1A104K	T	29.3/16.4

[LOGIC UNIT]

REF NO.	PARTS NO.	DESCRIPTION	M.	H/V LOCATION
C2214	4030016930	S.CER ECJ0EB1A104K	T	35.2/17.3
C2215	4030016930	S.CER ECJ0EB1A104K	T	29.3/11.1
C2217	4030016930	S.CER ECJ0EB1A104K	T	29.8/18.5
C2218	4030016930	S.CER ECJ0EB1A104K	T	26.5/20.1
C2219	4030016930	S.CER ECJ0EB1A104K	T	30.2/16.4
C2220	4030016930	S.CER ECJ0EB1A104K	T	26.1/16.5
C2221	4030016930	S.CER ECJ0EB1A104K	T	27.9/16.5
C2222	4030016930	S.CER ECJ0EB1A104K	T	29.3/19.7
J651	6510024810	S.CON AXK6S60635P 2	B	71/24.9
J701	6510022070	S.CON AXK6S30635P 2	B	10.9/20.4
J1201	6510018891	S.CON 52559-1370(1390)	B	77.5/38.2
J2101	6510020130	S.CON AXN810535P	T	52.4/42.9
BT1301	3020000330	LIT ML920S/F9D		
EP2	6910012350	S.BEA MMZ1608Y 102BT	T	18.8/38.2
EP51	6910012350	S.BEA MMZ1608Y 102BT	B	18.1/29.7
EP201	6910014730	S.BEA MPZ2012S331A-T	T	13.3/40.6
EP301	6910012350	S.BEA MMZ1608Y 102BT	T	19.1/40
EP701	6910012350	S.BEA MMZ1608Y 102BT	B	5.6/15.3
EP2002	6910012350	S.BEA MMZ1608Y 102BT	B	38.2/27.6
EP2202	6910012350	S.BEA MMZ1608Y 102BT	T	19.1/22
EP2205	6910014730	S.BEA MPZ2012S331A-T	T	18.4/17.7
EP2217	6910015970	S.BEA MMZ1608B 301CT-AS	B	20.9/16.1

[CONNECT UNIT]

REF NO.	PARTS NO.	DESCRIPTION	M.	H/V LOCATION
J1	6510019971	S.CON 52808-1071	T	7.1/11.8
W1	8900016410	CAB OPC-1579A		

M.=Mounted side (T: Mounted on the Top side, B: Mounted on the Bottom side)
S.=Surface mount

[DDS UNIT]

REF NO.	PARTS NO.	DESCRIPTION	M.	H/V LOCATION
IC51	1190001811	S.IC AD9833BRMZ	T	38.7/3.5
IC52	1130012781	S.IC SN74AHC2G04HDC3 0	T	45/5.6
IC61	1130012610	S.IC SN74AHC1GU04DCKR	T	37.5/7.5
IC62	1130012850	S.IC SN74LVC3G34DCUR	T	51.3/24.7
IC251	1180002321	S.REG TK11218CMCL-G	B	29.5/16.2
IC301	1190002101	S.IC AD9951Y28Z	T	37.5/28.2
IC401	1110004080	S.IC UPC2709T-E3	T	50.1/47
IC451	1110006430	S.IC UPC1678GV-E1-A	T	34.1/50.2
IC801	1110006430	S.IC UPC1678GV-E1-A	T	18/13.7
IC901	1130012720	S.IC CD74HC4094PWR	T	5.4/64.7
Q1	1530002381	S.TRA 2SC4215-Y(Te85L,F)	T	20.4/3.1
Q101	1530002561	S.TRA 2SC4403-3-TL-E	T	26.5/6.4
Q151	1530003151	S.TRA 2SC4673D-TD-E	T	41.4/13.7
Q201	1530003432	S.TRA 2SC5226A-4-TL-E	T	43.4/19.4
Q211	1530003432	S.TRA 2SC5226A-4-TL-E	B	43.5/15.2
Q301	1590000680	S.TRA DTC114EU T106	B	45.3/32.3
Q901	1590003930	S.TRA UMD22N TR	T	4/58.7
Q902	1590003930	S.TRA UMD22N TR	T	4.1/55.1
Q903	1590003930	S.TRA UMD22N TR	T	7.2/55.1
Q904	1590003930	S.TRA UMD22N TR	T	7.2/58.7
Q905	1590003930	S.TRA UMD22N TR	T	4.1/70.7
Q906	1590003930	S.TRA UMD22N TR	T	4.1/74.2
Q907	1590003930	S.TRA UMD22N TR	T	7.1/70.7
Q908	1590003930	S.TRA UMD22N TR	T	7.1/74.2
Q1101	1530002060	S.TRA 2SC4081 T106 R	T	40.9/53.9
Q1102	1540000451	S.TRA 2SD1623T-TD-E	T	45.5/54.3
D301	1750000620	S.DIO MA717WK(TX)	B	44.8/35.9
D341	1790001621	S.DIO 1SV308(TPL3,F)	B	45.2/39.7
D451	1750000581	S.DIO 1SV307(TPH3,F)	T	44.2/47.7
D452	1750000581	S.DIO 1SV307(TPH3,F)	T	44/44.8
D453	1790001621	S.DIO 1SV308(TPL3,F)	T	43.3/36.6
D454	1750000581	S.DIO 1SV307(TPH3,F)	T	38.3/48.3
D456	1750000620	S.DIO MA717WK(TX)	B	35.1/42.8
D458	1750000581	S.DIO 1SV307(TPH3,F)	T	33.8/45.6
D459	1750000581	S.DIO 1SV307(TPH3,F)	T	31.3/38.8
D471	1750000620	S.DIO MA717WK(TX)	T	33.2/36.6
D501	1750000581	S.DIO 1SV307(TPH3,F)	B	26.2/42.6
D502	1750000581	S.DIO 1SV307(TPH3,F)	T	3/50.6
D551	1750000581	S.DIO 1SV307(TPH3,F)	T	25.9/45.1
D552	1750000581	S.DIO 1SV307(TPH3,F)	T	2.9/45.3
D601	1750000581	S.DIO 1SV307(TPH3,F)	T	27.2/39.9
D602	1750000581	S.DIO 1SV307(TPH3,F)	T	2.9/40.1
D651	1750000581	S.DIO 1SV307(TPH3,F)	T	27.2/34.8
D652	1750000581	S.DIO 1SV307(TPH3,F)	T	2.9/34.9
D701	1750000581	S.DIO 1SV307(TPH3,F)	T	27.2/29.5
D702	1750000581	S.DIO 1SV307(TPH3,F)	T	2.9/29.7
D751	1750000581	S.DIO 1SV307(TPH3,F)	T	27/24.4
D752	1750000581	S.DIO 1SV307(TPH3,F)	T	2.9/24.6
D801	1750000581	S.DIO 1SV307(TPH3,F)	T	28.3/21.6
D802	1750000581	S.DIO 1SV307(TPH3,F)	T	2.9/19.3
D1101	1750000301	S.DIO 1SS302(Te85R,F)	T	40.9/57.7
D1102	1160000080	S.DIO DAP202K T146	B	27.9/63
FI101	2010002660	S.XTA DSF334SAF 124.032 MHz(FL-391)	T	29.3/10.7
FI201	2040001860	S.SAW NSVS776	T	34.5/16.5
X1	6050012800	S.XTA CR-788B VC-TXCO 24.8064 MHz	T	13.8/3.7
L1	6200002641	S.COI NLV25T-R15J	T	26/3.7
L51	6200005011	S.COI NLV25T-100J	B	35.6/4.2
L52	6200005011	S.COI NLV25T-100J	B	38.8/3.8
L53	6200003241	S.COI NLV32T-221J	B	43.4/8.7
L54	6200009351	S.COI ELJRE R22GFA	T	34.6/8.6
L101	6200003540	S.COI MLF1608D R22K-T	T	24.2/8.8
L105	6200012650	S.COI MLF1608A 1R5J-T	T	23.7/5.2
L151	6200004470	S.COI MLF1608D R12K-T	T	44.7/12.8
L153	6200004150	S.COI MLF1608D 47NM-T	T	46.9/15.7
L201	6200004150	S.COI MLF1608D 47NM-T	T	44.5/21.5
L202	6200005661	S.COI ELJRE 10NGFA	B	37.5/12.4
L204	6200003540	S.COI MLF1608D R22K-T	T	41.5/19.3
L205	6200005711	S.COI ELJRE 27NGFA	B	47.1/21.7
L206	6200005701	S.COI ELJRE 22NGFA	B	46.2/20.4
L210	6200005701	S.COI ELJRE 22NGFA	B	47/19.1
L212	6200002581	S.COI NLV25T-033J	B	41.9/12.8
L213	6200005681	S.COI ELJRE 15NGFA	B	40.1/17.8
L301	6140002810	S.COI LR-317	T	48.5/30
L302	6140002810	S.COI LR-317	T	48.7/38.9
L303	6200004150	S.COI MLF1608D 47NM-T	B	41.9/35.7
L304	6200003960	S.COI MLF1608A 1R0K-T	T	50.4/33.2
	6200003960	S.COI MLF1608A 1R0K-T	[EUR]	
	6200003960	S.COI MLF1608A 1R0K-T	[FRA]	
	6200003960	S.COI MLF1608A 1R0K-T	[ESP]	
	6200003960	S.COI MLF1608A 1R0K-T	[USA]	
	6200003960	S.COI MLF1608A 1R0K-T	[EXP]	
	6200003960	S.COI MLF1608A 1R0K-T	[ITR]	
	6200003960	S.COI MLF1608A 1R0K-T	[UK]	
	6200003960	S.COI MLF1608A 1R0K-T	[KOR]	
	6200003960	S.COI MLF1608A 1R0K-T	[CHN]	
L321	6200009560	S.COI MLG1608B R10J-T	T	50.4/34.7
L322	6200011770	S.COI LQW18ANR10G00D	T	47.8/34.7
L323	6200005671	S.COI ELJRE 12NGFA	T	53.6/30.1
L331	6200009680	S.COI MLG1608B 47NJ-T	T	47.6/43.1
L332	6200009680	S.COI MLG1608B 47NJ-T	T	50.2/43.1

[DDS UNIT]

REF NO.	PARTS NO.	DESCRIPTION	M.	H/V LOCATION
L341	6200004470	S.COI MLF1608D R12K-T	B	41.1/37
L401	6200001981	S.COI NLV25T-1R0J	T	50.2/49.9
L411	6200009610	S.COI MLG1608B 39NJ-T	T	47.3/48.3
L456	6140002810	S.COI LR-317	T	40.1/44.9
L458	6200009680	S.COI MLG1608B 47NJ-T	B	37.5/42.1
L461	6200009660	S.COI MLG1608B 10NJ-T	B	39.3/41.7
L464	6200002631	S.COI NLV25T-R10J	T	28.8/50.6
L465	6200004470	S.COI MLF1608D R12K-T	T	42.9/39.5
L466	6200011580	S.COI LQW18AN33NG00D	T	39.1/41.1
L467	6200009670	S.COI MLG1608B 12NJ-T	T	27.7/47.1
L468	6200009590	S.COI MLG1608B 18NJ-T	T	26.1/48.3
L469	6200009580	S.COI MLG1608B 15NJ-T	T	33.6/41.3
L471	6140002810	S.COI LR-317	T	38.7/37.2
L472	6200009680	S.COI MLG1608B 47NJ-T	T	33.4/39.3
L473	6200009540	S.COI MLG1608B 22NJ-T	T	35.5/40.4
L501	6200002611	S.COI NLV25T-R47J	B	21.7/43.6
L502	6200002631	S.COI NLV25T-R10J	B	18.1/46.7
L503	6200002431	S.COI NLV25T-082J	B	15/46.4
L504	6200002411	S.COI NLV25T-056J	T	14.3/49.1
L505	6200002421	S.COI NLV25T-068J	T	11.2/50.2
L506	6200002421	S.COI NLV25T-068J	T	8.2/49.7
L507	6200002611	S.COI NLV25T-R47J	T	3.8/48.2
L551	6200002611	S.COI NLV25T-R47J	T	24.9/42.6
L552	6200002421	S.COI NLV25T-068J	T	20.3/43
L553	6200002411	S.COI NLV25T-056J	T	17.6/42.9
L554	6200002601	S.COI NLV25T-047J	T	14.7/45
L555	6200002601	S.COI NLV25T-047J	T	12/44.3
L556	6200002581	S.COI NLV25T-033J	T	9.2/45
L557	6200002611	S.COI NLV25T-R47J	T	4.5/42.8
L601	6200002611	S.COI NLV25T-R47J	T	25.3/37.4
L602	6200002601	S.COI NLV25T-047J	T	22.6/39.6
L603	6200002591	S.COI NLV25T-039J	T	19.7/39.1
L604	6200003891	S.COI NLV25T-027J	T	16.8/39.9
L605	6200002601	S.COI NLV25T-047J	T	14.1/37.9
L606	6200002601	S.COI NLV25T-047J	T	11.4/37.7
L607	6200002421	S.COI NLV25T-068J	T	8.6/37.7
L608	6200002601	S.COI NLV25T-047J	T	5.1/37.7
L651	6200002611	S.COI NLV25T-R47J	T	26/32.2
L652	6200002591	S.COI NLV25T-039J	T	22.4/32.5
L653	6200002591	S.COI NLV25T-039J	T	19.6/32.8
L654	6200002591	S.COI NLV25T-039J	T	14/34.6
L655	6200002591	S.COI NLV25T-039J	T	11.2/33.9
L656	6200002601	S.COI NLV25T-047J	T	16.7/32.5
L657	6200002581	S.COI NLV25T-033J	T	7.9/34.6
L658	6200002611	S.COI NLV25T-R47J	T	5.2/32.6
L701	6200002611	S.COI NLV25T-R47J	T	26/26.9
L702	6200002581	S.COI NLV25T-033J	T	22.9/29.2
L703	6200002581	S.COI NLV25T-033J	T	20.2/28.7
L704	6200003891	S.COI NLV25T-027J	T	17.3/29.5
L705	6200002591	S.COI NLV25T-039J	T	14.6/27.3
L706	6200002581	S.COI NLV25T-033J	T	11.8/27.3
L707	6200002581	S.COI NLV25T-033J	T	9.1/27.2
L708	6200002611	S.COI NLV25T-R47J	T	4.5/27.2
L751	6200002611	S.COI NLV25T-R47J	T	25.9/22
L752	6200003881	S.COI NLV25T-022J	T	22.4/22.2
L753	6200003891	S.COI NLV25T-027J	T	19.7/22.2
L754	6200002581	S.COI NLV25T-033J	T	16.9/22.5
L755	6200003891	S.COI NLV25T-027J	T	14.2/22.1
L756	6200003891	S.COI NLV25T-027J	T	11.4/23.5
L757	6200003881	S.COI NLV25T-022J	T	8.7/24.2
L758	6200002611	S.COI NLV25T-R47J	T	3.9/22.2
L801	6200002181	S.COI NLV25T-R12J	T	28.3/17.5
L803	6200005711	S.COI ELJRE 27NGFA	T	26.3/17.6
L804	6200009070	S.COI LQW18AN18NG00D	T	25/15.6
L805	6200009220	S.COI LQW18AN15NG00D	T	23.1/14.9
		(LQW1608A15NG00)		
L806	6200005641	S.COI ELJRE 6N8ZFA	T	21.5/19
L807	6200009670	S.COI MLG1608B 12NJ-T	T	18.7/18.2
L808	6200004720	S.COI MLF1608D R10K-T	T	17.9/10
L812	6200005711	S.COI ELJRE 27NGFA	T	14.8/14.4
L813	6200009070	S.COI LQW18AN18NG00D	T	15.7/17.2
		(LQW1608A18NG00)		
L814	6200009220	S.COI LQW18AN15NG00D	T	13.8/18.2
		(LQW1608A15NG00)		
L815	6200005641	S.COI ELJRE 6N8ZFA	T	10.1/18
L816	6200010700	S.COI LQW18AN12NG00D	T	6.6/17.8
L818	6200002181	S.COI NLV25T-R12J	T	4.6/17
L851	6200002181	S.COI NLV25T-R12J	B	26.8/30.6
L852	6200002611	S.COI NLV25T-R47J	B	26.4/34.1
L853	6200002181	S.COI NLV25T-R12J	B	3.4/22.8
L854	6200002611	S.COI NLV25T-R47J	B	5.4/26
L901	6200007420	S.COI ELJFC 101K-F	B	3.7/65.9
L953	6200002041	S.COI NLV25T-101J	B	56.4/44.6
L954	6200002041	S.COI NLV25T-101J	B	55.7/42.1
L955	6200002041	S.COI NLV25T-101J	B	55.9/39.6
L956	6200002041	S.COI NLV25T-101J	B	56.1/37.1
L957	6200002041	S.COI NLV25T-101J	B	55.9/34.6
L959	6200011300	S.COI EXCML16A270U	T	54.9/34.3
L960	6200002041	S.COI NLV25T-101J	B	56.6/30.3
L962	6200011300	S.COI EXCML16A270U	B	59.2/32.2
L963	6200011300	S.COI EXCML16A270U	B	60.4/32.2
L1001	6200003241	S.COI NLV32T-221J	B	53.7/50.8
L1002	6200003241	S.COI NLV32T-221J	B	47.9/55
L1103	6200002041	S.COI NLV25T-101J	B	42.2/61.2
L1105	6200002041	S.COI NLV25T-101J	B	40.8/71.8
L1106	6200002041	S.COI NLV25T-101J	T	36.4/62.3
L1107	6200002041	S.COI NLV25T-101J	B	34.9/74.7
L1110	6200002041	S.COI NLV25T-101J	T	32.4/62.3

M.=Mounted side (T: Mounted on the Top side, B: Mounted on the Bottom side) S.=Surface mount

[DDS UNIT]

REF NO.	PARTS NO.	DESCRIPTION	M.	H/V LOCATION
L1111	6200002041	S.COI NLV25T-101J	B	26.1/69.8
L1112	6200002041	S.COI NLV25T-101J	T	29.9/62.3
L1152	6200003590	S.COI EXCCL325U1	T	48.3/69.2
L1153	6200002041	S.COI NLV25T-101J	T	45.5/69.3
L1154	6200002041	S.COI NLV25T-101J	T	53.6/69.2
R2	7030007290	S.RES ERJ2GEJ 222 X (2.2K)	T	19.1/4.5
R3	7030005040	S.RES ERJ2GEJ 472 X (4.7K)	T	18.6/1.8
R4	7030004990	S.RES ERJ2GEJ 221 X (220)	T	22.2/2.6
R5	7030004980	S.RES ERJ2GEJ 101 X (100)	T	20.9/6.9
R8	7030003630	S.RES ERJ3GEYJ 393 V (39K)	B	13.6/7.1
R9	7030003610	S.RES ERJ3GEYJ 273 V (27K)	B	13.6/9.7
R10	7030005060	S.RES ERJ2GEJ 333 X (33K)	T	8/3.2
R11	7030010040	S.RES ERJ2GEJ-JPW	T	9.2/3.7
R51	7030005120	S.RES ERJ2GEJ 102 X (1K)	T	35.7/9.5
R52	7030005120	S.RES ERJ2GEJ 102 X (1K)	T	46.1/2.3
R53	7030005120	S.RES ERJ2GEJ 102 X (1K)	T	42.8/3.5
R54	7030005120	S.RES ERJ2GEJ 102 X (1K)	T	42.8/3.5
R61	7030005050	S.RES ERJ2GEJ 103 X (10K)	T	39.3/8.1
R62	7030005530	S.RES ERJ2GEJ 100 X (10)	T	49.3/23.1
R101	7030005000	S.RES ERJ2GEJ 471 X (470)	T	25.2/7.8
R102	7030004980	S.RES ERJ2GEJ 101 X (100)	T	22.1/7.4
R103	7030005570	S.RES ERJ2GEJ 820 X (82)	T	31.8/11.1
R104	7030004980	S.RES ERJ2GEJ 101 X (100)	T	33/11.5
R105	7030005570	S.RES ERJ2GEJ 820 X (82)	T	34.2/11.2
R106	7030005100	S.RES ERJ2GEJ 154 X (150K)	T	23.9/7.4
R121	7030005040	S.RES ERJ2GEJ 472 X (4.7K)	T	38.5/11.1
R150	7030005570	S.RES ERJ2GEJ 820 X (82)	T	45.8/10.7
R151	7030004980	S.RES ERJ2GEJ 101 X (100)	T	44.9/10.7
R154	7030005050	S.RES ERJ2GEJ 103 X (10K)	T	41.4/10.6
R155	7030005530	S.RES ERJ2GEJ 100 X (10)	T	46.3/12.6
R157	7030007270	S.RES ERJ2GEJ 151 X (150)	T	48.8/18.2
R158	7030009200	S.RES ERJ2GEJ 390 X (39)	T	48/16.7
R159	7030007270	S.RES ERJ2GEJ 151 X (150)	T	47.9/18.2
R160	7030005300	S.RES ERJ2GEJ 150 X (15)	T	44.2/15.9
R161	7030004980	S.RES ERJ2GEJ 101 X (100)	T	45.1/15.9
R162	7030005300	S.RES ERJ2GEJ 150 X (15)	T	45/14.6
R201	7030005530	S.RES ERJ2GEJ 100 X (10)	T	45.8/22
R202	7030000700	S.RES MCR10EZHJ 470 K (474)	T	45.6/18.8
R211	7030003400	S.RES ERJ3GEYJ 471 V (470)	B	37.3/17.8
R212	7030003440	S.RES ERJ3GEYJ 102 V (1K)	B	40.8/16.2
R213	7030003200	S.RES ERJ3GEYJ 100 V (10)	B	44.5/11.4
R214	7030003280	S.RES ERJ3GEYJ 470 V (47)	B	46.8/16.3
R301	7030005120	S.RES ERJ2GEJ 102 X (1K)	T	34.2/22.2
R303	7030010040	S.RES ERJ2GEJ-JPW	T	40/22.2
R304	7030005120	S.RES ERJ2GEJ 102 X (1K)	T	42/24.6
R305	7030005710	S.RES ERJ2GEJ 121 X (120)	T	44.1/28.9
R306	7030005120	S.RES ERJ2GEJ 102 X (1K)	T	31.5/25.6
R309	7030005120	S.RES ERJ2GEJ 102 X (1K)	T	31.2/29.4
R310	7030005120	S.RES ERJ2GEJ 102 X (1K)	T	31.2/30.5
R311	7030005120	S.RES ERJ2GEJ 102 X (1K)	T	31.2/31.5
R312	7030010040	S.RES ERJ2GEJ-JPW	T	32.9/31.7
R313	7030005710	S.RES ERJ2GEJ 121 X (120)	T	43.2/28.5
R314	7030009140	S.RES ERJ2GEJ 272 X (2.7K)	T	43/31.8
R315	7030005120	S.RES ERJ2GEJ 102 X (1K)	T	33.5/32.6
R316	7030005050	S.RES ERJ2GEJ 103 X (10K)	T	34.6/33.8
R317	7030004990	S.RES ERJ2GEJ 221 X (220)	T	43.9/31.8
R318	7030003860	S.RES ERJ3GE JPW V	[EUR] B	35.8/28.4
	7030003860	S.RES ERJ3GE JPW V	[FRA]	
	7030003860	S.RES ERJ3GE JPW V	[ESP]	
	7030003860	S.RES ERJ3GE JPW V	[USA]	
	7030003860	S.RES ERJ3GE JPW V	[EXP]	
	7030003860	S.RES ERJ3GE JPW V	[ITR]	
	7030003860	S.RES ERJ3GE JPW V	[KOR]	
	7030003860	S.RES ERJ3GE JPW V	[AUS]	
	7030003860	S.RES ERJ3GE JPW V	[CHN]	
R341	7030003440	S.RES ERJ3GEYJ 102 V (1K)	B	44.3/38.3
R342	7030003440	S.RES ERJ3GEYJ 102 V (1K)	B	45.9/41.2
R451	7030005120	S.RES ERJ2GEJ 102 X (1K)	T	44.5/46.2
R452	7030003860	S.RES ERJ3GE JPW V	B	48.6/44.6
R453	7030010090	S.RES ERJ2GEJ 180 X (18)	T	34.1/47.4
R454	7030008280	S.RES ERJ2GEJ 271 X (270)	T	32.9/47
R455	7030008280	S.RES ERJ2GEJ 271 X (270)	T	32.9/47.9
R456	7030010040	S.RES ERJ2GEJ-JPW	T	34.9/52.4
R457	7030005120	S.RES ERJ2GEJ 102 X (1K)	T	38.1/49.7
R458	7030004990	S.RES ERJ2GEJ 221 X (220)	T	31.6/43.6
R459	7030005090	S.RES ERJ2GEJ 104 X (100K)	T	42.1/50
R460	7030003680	S.RES ERJ3GEYJ 104 V (100K)	T	30.7/41
R461	7030005090	S.RES ERJ2GEJ 104 X (100K)	T	29.6/39.1
R462	7030003860	S.RES ERJ3GE JPW V	T	45/43.3
R463	7030003400	S.RES ERJ3GEYJ 471 V (470)	T	33.3/44
R464	7030004980	S.RES ERJ2GEJ 101 X (100)	T	40.8/47.9
R465	7030005570	S.RES ERJ2GEJ 820 X (82)	T	40.3/50
R467	7030005570	S.RES ERJ2GEJ 820 X (82)	T	40.8/48.8
R468	7030005570	S.RES ERJ2GEJ 820 X (82)	T	41.2/50
R469	7030003320	S.RES ERJ3GEYJ 101 V (100)	B	37.7/39.9
R471	7030005000	S.RES ERJ2GEJ 471 X (470)	T	41.6/37.7
R472	7030004990	S.RES ERJ2GEJ 221 X (220)	T	30.3/43.3
R473	7030007270	S.RES ERJ2GEJ 151 X (150)	T	31.7/34.5
R474	7030009200	S.RES ERJ2GEJ 390 X (39)	T	31.3/35.7
R475	7030007270	S.RES ERJ2GEJ 151 X (150)	T	30.1/35.3
R476	7030005000	S.RES ERJ2GEJ 471 X (470)	T	29.9/37.9
R477	7030003320	S.RES ERJ3GEYJ 101 V (100)	B	35.7/38.6
R501	7030003390	S.RES ERJ3GEYJ 391 V (390)	B	21/46.1
R502	7030009280	S.RES ERJ2GEJ 391 X	T	5.8/46.8
R503	7030005090	S.RES ERJ2GEJ 104 X (100K)	T	14.3/46.8
R505	7030005570	S.RES ERJ2GEJ 820 X (82)	T	6.5/48.6
R506	7030005570	S.RES ERJ2GEJ 820 X (82)	T	6/49.8

[DDS UNIT]

REF NO.	PARTS NO.	DESCRIPTION	M.	H/V LOCATION
R507	7030005570	S.RES ERJ2GEJ 820 X (82)	T	5.6/48.6
R551	7030009280	S.RES ERJ2GEJ 391 X	T	23.1/42
R552	7030009280	S.RES ERJ2GEJ 391 X	T	6.3/42
R553	7030005090	S.RES ERJ2GEJ 104 X (100K)	T	10.1/41.6
R554	7030009200	S.RES ERJ2GEJ 390 X (39)	T	6.4/45.7
R555	7030007270	S.RES ERJ2GEJ 101 X (150)	T	7.1/44.4
R556	7030007270	S.RES ERJ2GEJ 151 X (150)	T	6.2/44.3
R601	7030008280	S.RES ERJ2GEJ 271 X (270)	T	23.2/36.1
R602	7030009280	S.RES ERJ2GEJ 391 X	T	6.8/36.6
R603	7030005090	S.RES ERJ2GEJ 104 X (100K)	T	19.6/36.4
R604	7030004980	S.RES ERJ2GEJ 101 X (100)	T	20.8/36.1
R651	7030009280	S.RES ERJ2GEJ 391 X	T	24.2/31.2
R652	7030009280	S.RES ERJ2GEJ 391 X	T	6.3/30.5
R653	7030005090	S.RES ERJ2GEJ 104 X (100K)	T	9.9/31.2
R701	7030009280	S.RES ERJ2GEJ 391 X	T	23.8/25.8
R702	7030009280	S.RES ERJ2GEJ 391 X	T	6.5/26
R703	7030005090	S.RES ERJ2GEJ 104 X (100K)	T	19.9/26
R704	7030004980	S.RES ERJ2GEJ 101 X (100)	T	7.2/27.2
R705	7030005710	S.RES ERJ2GEJ 121 X (120)	T	6.7/28.4
R706	7030004980	S.RES ERJ2GEJ 101 X (100)	T	6.3/27.2
R751	7030009280	S.RES ERJ2GEJ 391 X	T	24.2/21
R752	7030009280	S.RES ERJ2GEJ 391 X	T	5.9/20.8
R753	7030005090	S.RES ERJ2GEJ 104 X (100K)	T	10.3/20.8
R755	7030004980	S.RES ERJ2GEJ 101 X (100)	T	6.6/22.6
R756	7030005580	S.RES ERJ2GEJ 560 X (56)	T	6.6/24.2
R757	7030004980	S.RES ERJ2GEJ 101 X (100)	T	5.7/23.3
R801	7030008280	S.RES ERJ2GEJ 271 X (270)	T	27.2/14.5
R805	7030005570	S.RES ERJ2GEJ 820 X (82)	T	13.9/10.3
R806	7030005570	S.RES ERJ2GEJ 820 X (82)	T	14.2/11.7
R807	7030005570	S.RES ERJ2GEJ 820 X (82)	T	13/11.3
R808	7030003390	S.RES ERJ3GEYJ 391 V (390)	B	3.6/17.9
R810	7030005090	S.RES ERJ2GEJ 104 X (100K)	T	27.2/15.4
R841	7030005710	S.RES ERJ2GEJ 121 X (120)	T	21.2/12.5
R851	7030009280	S.RES ERJ2GEJ 391 X	T	27.1/37.3
R852	7030008280	S.RES ERJ2GEJ 271 X (270)	T	5.7/13.7
R853	7030010090	S.RES ERJ2GEJ 180 X (18)	T	6.9/14
R854	7030008280	S.RES ERJ2GEJ 271 X (270)	T	6.9/13
R855	7030003390	S.RES ERJ3GEYJ 391 V (390)	B	5.5/29.5
R901	7030005120	S.RES ERJ2GEJ 102 X (1K)	T	2.1/62.6
R902	7030005120	S.RES ERJ2GEJ 102 X (1K)	T	2.2/60.9
R903	7030005120	S.RES ERJ2GEJ 102 X (1K)	T	2.2/58.7
R951	7030003360	S.RES ERJ3GEYJ 221 V (220)	B	59.2/6.9
R952	7030004990	S.RES ERJ2GEJ 221 X (220)	T	54/9.3
R953	7030003360	S.RES ERJ3GEYJ 221 V (220)	B	59.5/3.3
R954	7030004990	S.RES ERJ2GEJ 221 X (220)	T	53.1/8.9
R955	7030004990	S.RES ERJ2GEJ 221 X (220)	T	55.2/7.7
R956	7030003360	S.RES ERJ3GEYJ 221 V (220)	B	59.2/4.9
R957	7030003360	S.RES ERJ3GEYJ 221 V (220)	B	56.6/5
R958	7030004990	S.RES ERJ2GEJ 221 X (220)	T	47.2/6.1
R959	7030003360	S.RES ERJ3GEYJ 221 V (220)	B	57.9/5.1
R960	7030003280	S.RES ERJ3GEYJ 470 V (47)	B	57.5/49
R961	7030004990	S.RES ERJ2GEJ 221 X (220)	T	54.6/11.6
R962	7030003860	S.RES ERJ3GE JPW V	T	51.3/21
R1051	7030003860	S.RES ERJ3GE JPW V	B	10.8/73
R1101	7030005120	S.RES ERJ2GEJ 102 X (1K)	T	40.5/52.1
R1102	7030005050	S.RES ERJ2GEJ 103 X (10K)	T	42.1/52.1
R1103	7030004980	S.RES ERJ2GEJ 101 X (100)	T	39.3/63.4
R1104	7030005050	S.RES ERJ2GEJ 103 X (10K)	T	44.2/51.2
R1105	7030004980	S.RES ERJ2GEJ 101 X (100)	T	38.7/60.9
R1106	7030007290	S.RES ERJ2GEJ 222 X (2.2K)	T	31.8/59.6
R1107	7030007290	S.RES ERJ2GEJ 222 X (2.2K)	T	28.1/59.6
R1108	7030005240	S.RES ERJ2GEJ 473 X (47K)	T	46.9/8.5
R1109	7030005240	S.RES ERJ2GEJ 473 X (47K)	T	47.9/8.5
C1	4030016950	S.CER ECJ0EB1A473K	T	17.5/4.5
C2	4030017780	S.CER ECJ0EB1E472K	T	20.9/5
C3	4030017510	S.CER ECJ0EC1H680J	T	24.8/1.7
C4	4030017780	S.CER ECJ0EB1E472K	T	22.3/4.6
C5	4030017680	S.CER ECJ0EC1H820J	T	26/2
C6	4030017510	S.CER ECJ0EC1H680J	T	27.2/1.7
C7	4030016930	S.CER ECJ0EB1A104K	T	8/4.1
C8	4030016790	S.CER ECJ0EB1C103K	T	10.1/5.7
C51	4030017780	S.CER ECJ0EB1E472K	T	33.8/6.5
C52	4030017780	S.CER ECJ0EB1E472K	T	36.1/5.3
C53	4030017780	S.CER ECJ0EB1E472K	T	36.9/9.4
C54	4030016930	S.CER ECJ0EB1A104K	T	34.9/4.4
C55	4510008580	S.ELE EEE0JA470SR	T	30.6/3.9
C56	4030016930	S.CER ECJ0EB1A104K	T	34.9/2.8
C57	4030016930	S.CER ECJ0EB1A104K	T	42.8/5
C58	4030016930	S.CER ECJ0EB1A104K	T	41.5/9
C59	4030017720	S.CER ECJ0EB1H331K	T	41.9/6.6
C60	4030017690	S.CER ECJ0EC1H121J	T	42.2/7.8
C61	4030017720	S.CER ECJ0EB1H331K	T	42.8/6.6
C62	4030016930	S.CER ECJ0EB1A104K	T	35.6/6.5
C63	4030016930	S.CER ECJ0EB1A104K	T	49.3/22.2
C64	4030017710	S.CER ECJ0EC1H181J	T	34.7/6.5
C65	4030017710	S.CER ECJ0EC1H181J	T	33.4/8.9
C101	4030017580	S.CER ECJ0EC1H060C	T	26.4/8.7
C102	4030017660	S.CER ECJ0EC1H330J	T	23.1/2.6
C104	4030017780	S.CER ECJ0EB1E472K	T	20.9/7.8
C105	4030017460	S.CER ECJ0EB1E102K	T	24.8/6.5
C120	4030017780	S.CER ECJ0EB1E472K	T	37.3/11.5
C126	4030017780	S.CER ECJ0EB1E472		

[DDS UNIT]

REF NO.	PARTS NO.	DESCRIPTION	M.	H/V LOCATION
C156	4030017660	S.CER ECJ0EC1H330J	T	47/18.2
C157	4030007090	S.CER C1608 CH 1H 470J-T	B	53/15.3
C202	4030017590	S.CER ECJ0EC1H070C	T	43.8/17.2
C203	4030007060	S.CER C1608 CH 1H 270J-T	B	37.8/15.9
C204	4030016930	S.CER ECJ0EB1A104K	T	35.1/20.1
C206	4030017560	S.CER ECJ0EC1H2R5B	T	43.4/21.7
C207	4030007110	S.CER C1608 CH 1H 680J-T	B	44/21.7
C208	4030009910	S.CER C1608 CH 1H 040B-T	B	40.9/21.7
C209	4030007060	S.CER C1608 CH 1H 270J-T	B	43.1/20.4
C210	4030009910	S.CER C1608 CH 1H 040B-T	B	40.8/19.8
C211	4030017460	S.CER ECJ0EB1E102K	T	42.2/17.6
C216	4030017780	S.CER ECJ0EB1E472K	T	46.3/20.8
C217	4030007120	S.CER C1608 CH 1H 820J-T	B	43.9/19.1
C218	4030011770	S.CER C1608 CH 1H 060B-T	B	43.2/17.8
C219	4030007010	S.CER C1608 CH 1H 100D-T	B	46.2/17.8
C221	4030006880	S.CER C1608 JB 1H 472K-T	B	46/15
C222	4030009910	S.CER C1608 CH 1H 040B-T	B	40.7/14.7
C223	4030006880	S.CER C1608 JB 1H 472K-T	B	46/13.4
C224	4030018630	S.CER C2012 CH 1H 472J-T	B	39.2/11.4
C225	4030006860	S.CER C1608 JB 1H 102K-T	B	38.4/19.4
C251	4030011600	S.CER C1608 JB 1E 104K-T	B	27.6/12.2
C252	4030011600	S.CER C1608 JB 1E 104K-T	B	28.7/23.5
C253	4550007090	S.TAN TEESVA 1A 226M8R	B	29.6/21.7
C254	4030011600	S.CER C1608 JB 1E 104K-T	B	29.2/12.2
C255	4550007090	S.TAN TEESVA 1A 226M8R	B	29.5/19.3
C302	4030016930	S.CER ECJ0EB1A104K	T	36.2/22.2
C303	4030016930	S.CER ECJ0EB1A104K	T	37.3/22.2
C304	4030016930	S.CER ECJ0EB1A104K	T	38.2/22.2
C305	4030016930	S.CER ECJ0EB1A104K	T	39.1/22.2
C306	4030016930	S.CER ECJ0EB1A104K	T	43.6/24.6
C307	4030016930	S.CER ECJ0EB1A104K	T	31.2/28.3
C308	4030016930	S.CER ECJ0EB1A104K	T	43.6/25.5
C309	4030016930	S.CER ECJ0EB1A104K	T	43/26.7
C310	4030016930	S.CER ECJ0EB1A104K	T	43.9/26.7
C312	4030016930	S.CER ECJ0EB1A104K	T	43.4/30.6
C317	4030011600	S.CER C1608 JB 1E 104K-T	B	44/26.1
C318	4030006880	S.CER C1608 JB 1H 472K-T	B	39.2/25.4
C321	4030017420	S.CER ECJ0EC1H470J	T	51.2/30.2
C323	4030017510	S.CER ECJ0EC1H680J	T	48.6/33.3
C325	4030017660	S.CER ECJ0EC1H330J	T	48.8/35.7
C326	4030017640	S.CER ECJ0EC1H150J	T	53.1/32
C328	4030006880	S.CER C1608 JB 1H 472K-T	[EUR] B	39.7/29.6
	4030006880	S.CER C1608 JB 1H 472K-T	[FRA]	
	4030006880	S.CER C1608 JB 1H 472K-T	[ESP]	
	4030006880	S.CER C1608 JB 1H 472K-T	[USA]	
	4030006880	S.CER C1608 JB 1H 472K-T	[EXP]	
	4030006880	S.CER C1608 JB 1H 472K-T	[ITR]	
	4030006880	S.CER C1608 JB 1H 472K-T	[KOR]	
	4030006880	S.CER C1608 JB 1H 472K-T	[AUS]	
	4030006880	S.CER C1608 JB 1H 472K-T	[CHN]	
C331	4030017390	S.CER ECJ0EC1H180J	T	46.6/44.5
C333	4030017670	S.CER ECJ0EC1H390J	T	48.4/44.5
C335	4030017390	S.CER ECJ0EC1H180J	T	50.2/44.5
C341	4030007130	S.CER C1608 CH 1H 101J-T	[EUR] B	42.5/39.7
	4030007130	S.CER C1608 CH 1H 101J-T	[FRA]	
	4030007130	S.CER C1608 CH 1H 101J-T	[ESP]	
	4030007130	S.CER C1608 CH 1H 101J-T	[USA]	
	4030007130	S.CER C1608 CH 1H 101J-T	[EXP]	
	4030007130	S.CER C1608 CH 1H 101J-T	[ITR]	
	4030007090	S.CER C1608 CH 1H 470J-T	[UK]	
	4030007130	S.CER C1608 CH 1H 101J-T	[KOR]	
	4030007130	S.CER C1608 CH 1H 101J-T	[AUS]	
	4030007130	S.CER C1608 CH 1H 101J-T	[CHN]	
C342	4030007090	S.CER C1608 CH 1H 470J-T	B	43.7/42.1
C343	4030007140	S.CER C1608 CH 1H 121J-T	B	41.3/39
C344	4030007100	S.CER C1608 CH 1H 560J-T	B	42.7/34.3
C345	4030017510	S.CER ECJ0EC1H680J	T	45.5/37.9
C346	4030017510	S.CER ECJ0EC1H680J	T	45.7/39.7
C347	4030006860	S.CER C1608 JB 1H 102K-T	[EUR] B	48.4/31.7
	4030006860	S.CER C1608 JB 1H 102K-T	[FRA]	
	4030006860	S.CER C1608 JB 1H 102K-T	[ESP]	
	4030006860	S.CER C1608 JB 1H 102K-T	[USA]	
	4030006860	S.CER C1608 JB 1H 102K-T	[EXP]	
	4030006860	S.CER C1608 JB 1H 102K-T	[ITR]	
	4030006860	S.CER C1608 JB 1H 102K-T	[KOR]	
	4030006860	S.CER C1608 JB 1H 102K-T	[AUS]	
	4030006860	S.CER C1608 JB 1H 102K-T	[CHN]	
C401	4030017460	S.CER ECJ0EB1E102K	T	51.1/44.5
C402	4030017460	S.CER ECJ0EB1E102K	T	52.3/48.9
C403	4030017430	S.CER ECJ0EC1H101J	T	47.9/46.1
C411	4030017400	S.CER ECJ0EC1H220J	T	48.1/49.7
C412	4030017630	S.CER ECJ0EC1H120J	T	47.7/47.3
C413	4030017400	S.CER ECJ0EC1H220J	T	46.7/49.4
C451	4030017420	S.CER ECJ0EC1H470J	T	40.2/40.6
C453	4030017460	S.CER ECJ0EB1E102K	T	46.1/46.8
C454	4030017460	S.CER ECJ0EB1E102K	T	35.3/47.9
C456	4030016930	S.CER ECJ0EB1A104K	T	31.2/48
C457	4030017460	S.CER ECJ0EB1E102K	T	35.3/47
C458	4030017460	S.CER ECJ0EB1E102K	T	30.5/49.8
C459	4030017460	S.CER ECJ0EB1E102K	T	27/50.6
C460	4030017780	S.CER ECJ0EB1E472K	T	39.3/50
C461	4030006880	S.CER C1608 JB 1H 472K-T	T	30.7/42.2
C463	4030017420	S.CER ECJ0EC1H470J	T	40.6/41.8
C464	4030017690	S.CER ECJ0EC1H121J	T	41.5/40.2
C465	4030017400	S.CER ECJ0EC1H220J	T	37.7/41.8
C466	4030017570	S.CER ECJ0EC1H040B	T	38.1/40.6
C467	4030017400	S.CER ECJ0EC1H220J	T	37.2/40.6
C468	4030017360	S.CER ECJ0EC1H030B	T	29/48
C469	4030017370	S.CER ECJ0EC1H3R5B	T	29/47.1

[DDS UNIT]

REF NO.	PARTS NO.	DESCRIPTION	M.	H/V LOCATION
C470	4030017380	S.CER ECJ0EC1H050B	T	29/46.2
C471	4030017380	S.CER ECJ0EC1H050B	T	35.6/43.9
C472	4030017660	S.CER ECJ0EC1H330J	T	34.7/41.8
C473	4030017570	S.CER ECJ0EC1H040B	T	34/43
C474	4030017460	S.CER ECJ0EB1E102K	T	41.6/36.7
C475	4030017460	S.CER ECJ0EB1E102K	T	30.5/36.7
C476	4030017780	S.CER ECJ0EB1E472K	T	29.6/40
C477	4030017780	S.CER ECJ0EB1E472K	T	42.4/48.8
C478	4030006880	S.CER C1608 JB 1H 472K-T	B	39.8/39.1
C479	4030006880	S.CER C1608 JB 1H 472K-T	B	38/37.9
C480	4030017630	S.CER ECJ0EC1H120J	T	35.6/41.8
C481	4030017360	S.CER ECJ0EC1H030B	T	35.6/43
C501	4030007080	S.CER C1608 CH 1H 390J-T	B	19/42.6
C502	4030007120	S.CER C1608 CH 1H 820J-T	B	18.3/44.1
C503	4030007060	S.CER C1608 CH 1H 270J-T	B	16.1/43.8
C504	4030017780	S.CER ECJ0EB1E472K	T	16.1/49.3
C505	4030017660	S.CER ECJ0EC1H330J	T	12.6/47.2
C506	4030017620	S.CER ECJ0EC1H100C	T	12.1/48.4
C507	4030017500	S.CER ECJ0EC1H560J	T	11.4/47.2
C508	4030017580	S.CER ECJ0EC1H060C	T	10.5/48.4
C509	4030017420	S.CER ECJ0EC1H470J	T	10.2/47.2
C510	4030017350	S.CER ECJ0EC1H020B	T	8.9/47.5
C511	4030017670	S.CER ECJ0EC1H390J	T	7.7/47.2
C512	4030017780	S.CER ECJ0EB1E472K	T	5.5/50.7
C513	4030017780	S.CER ECJ0EB1E472K	T	15.9/46.8
C551	4030017650	S.CER ECJ0EC1H270J	T	22.5/45.4
C552	4030017500	S.CER ECJ0EC1H560J	T	21.1/45
C553	4030017650	S.CER ECJ0EC1H270J	T	19.2/45.4
C554	4030017780	S.CER ECJ0EB1E472K	T	15.6/43.2
C555	4030017670	S.CER ECJ0EC1H390J	T	14.5/42
C556	4030017350	S.CER ECJ0EC1H020B	T	14/43.2
C557	4030017420	S.CER ECJ0EC1H470J	T	13.1/42
C558	4030017590	S.CER ECJ0EC1H070C	T	10/43.2
C559	4030017420	S.CER ECJ0EC1H470J	T	8.9/42
C560	4030017630	S.CER ECJ0EC1H120J	T	8.4/43.2
C561	4030017660	S.CER ECJ0EC1H330J	T	7.9/42
C562	4030017780	S.CER ECJ0EB1E472K	T	4.9/45.3
C563	4030017780	S.CER ECJ0EB1E472K	T	11.7/41.6
C601	4030017780	S.CER ECJ0EB1E472K	T	24.7/39.9
C602	4030017400	S.CER ECJ0EC1H220J	T	23.3/37.6
C603	4030017360	S.CER ECJ0EC1H030B	T	21.9/37.8
C604	4030017630	S.CER ECJ0EC1H120J	T	13.3/40.4
C605	4030017620	S.CER ECJ0EC1H100C	T	11.6/40.4
C606	4030017660	S.CER ECJ0EC1H330J	T	18.4/36.9
C607	4030017600	S.CER ECJ0EC1H080C	T	17.7/38.1
C608	4030017650	S.CER ECJ0EC1H270J	T	17.2/36.9
C609	4030017640	S.CER ECJ0EC1H150J	T	16.1/38.1
C610	4030017640	S.CER ECJ0EC1H150J	T	15.9/36.9
C611	4030017440	S.CER ECJ0EC1H221J	T	12.1/39.5
C612	4030017510	S.CER ECJ0EC1H680J	T	10.2/40
C613	4030017620	S.CER ECJ0EC1H100C	T	8.2/40.1
C614	4030017640	S.CER ECJ0EC1H150J	T	5.4/40.3
C615	4030017670	S.CER ECJ0EC1H390J	T	6.8/39.9
C616	4030017780	S.CER ECJ0EB1E472K	T	6.8/38.2
C617	4030017780	S.CER ECJ0EB1E472K	T	22/36.4
C618	4030017650	S.CER ECJ0EC1H270J	T	3.3/37.1
C651	4030017620	S.CER ECJ0EC1H100C	T	24.6/34.8
C652	4030017450	S.CER ECJ0EB1E271K	T	23.7/34.8
C653	4030017590	S.CER ECJ0EC1H070C	T	21.7/35.2
C654	4030017680	S.CER ECJ0EC1H820J	T	20.4/34.8
C655	4030017600	S.CER ECJ0EC1H080C	T	19.2/35.2
C656	4030017420	S.CER ECJ0EC1H470J	T	17.9/34.8
C657	4030017630	S.CER ECJ0EC1H120J	T	16.5/35.2
C658	4030017340	S.CER ECJ0EC1H010B	T	13.3/32.8
C659	4030017360	S.CER ECJ0EC1H030B	T	9.4/32.6
C660	4030017640	S.CER ECJ0EC1H150J	T	14.6/32.3
C661	4030017650	S.CER ECJ0EC1H270J	T	12.8/31.6
C662	4030017400	S.CER ECJ0EC1H220J	T	8.5/31.6
C663	4030017380	S.CER ECJ0EC1H050B	T	8/32.8
C664	4030017460	S.CER ECJ0EB1E102K	T	5.4/34.9
C665	4030017390	S.CER ECJ0EC1H180J	T	7.6/31.6
C666	4030017780	S.CER ECJ0EB1E472K	T	11.5/31.2
C701	4030017460	S.CER ECJ0EB1E102K	T	25/29.3
C702	4030017640	S.CER ECJ0EC1H150J	T	23.6/27.2
C703	4030017540	S.CER ECJ0EC1HR75B	T	22.2/27.4
C704	4030017650	S.CER ECJ0EC1H270J	T	18.7/26.4
C705	4030017350	S.CER ECJ0EC1H020B	T	18.2/27.7
C706	4030017400	S.CER ECJ0EC1H220J	T	17.5/26.4
C707	4030017570	S.CER ECJ0EC1H040B	T	16.6/27.7
C708	4030017390	S.CER ECJ0EC1H180J	T	16.3/26.4
C709	4030017590	S.CER ECJ0EC1H070C	T	13.9/30
C710	4030017500	S.CER ECJ0EC1H560J	T	12.5/29.1
C711	4030017380	S.CER ECJ0EC1H050B	T	11.9/30
C712	4030017500	S.CER ECJ0EC1H560J	T	10.7/29.3
C713	4030017380	S.CER ECJ0EC1H050B	T	9.5/29.6
C714	4030017710	S.CER ECJ0EC1H181J	T	8.1/29.7
C715	4030017630	S.CER ECJ0EC1H120J	T	6.9/29.3
C716	4030017780	S.CER ECJ0EB1E472K	T	21.5/26
C717	4030017460	S.CER ECJ0EB1E102K	T	5.3/29.3
C751	4030017590	S.CER ECJ0EC1H070C	T	24.8/24.5
C752	4030017710	S.CER ECJ0EC1H181J	T	23.9/24.5
C753	4030017380	S.C		

[DDS UNIT]

REF NO.	PARTS NO.	DESCRIPTION	M.	H/V LOCATION
C761	4030017350	S.CER ECJ0EC1H020B	T	9.7/22.2
C762	4030017630	S.CER ECJ0EC1H120J	T	8.6/21.2
C763	4030017360	S.CER ECJ0EC1H030B	T	8.2/22.4
C764	4030017620	S.CER ECJ0EC1H100C	T	7.7/21.2
C765	4030017460	S.CER ECJ0EB1E102K	T	5.3/24.6
C766	4030017780	S.CER ECJ0EB1E472K	T	11.9/20.8
C802	4030017590	S.CER ECJ0EC1H070C	T	26.5/19.3
C803	4030017380	S.CER ECJ0EC1H050B	T	25.2/18.9
C804	4030017570	S.CER ECJ0EC1H040B	T	24.3/18.9
C806	4030017600	S.CER ECJ0EC1H080C	T	24.3/17.2
C807	4030017360	S.CER ECJ0EB1E102K	T	23.4/18.9
C808	4030017660	S.CER ECJ0EC1H330J	T	23/16.7
C809	4030017570	S.CER ECJ0EC1H040B	T	23/17.6
C810	4030017570	S.CER ECJ0EC1H040B	T	21.7/16.6
C811	4030017590	S.CER ECJ0EC1H070C	T	21.2/17.9
C812	4030017610	S.CER ECJ0EC1H090C	T	20.8/16.6
C813	4030017350	S.CER ECJ0EC1H020B	T	19.7/18.7
C814	4030017580	S.CER ECJ0EC1H060C	T	19.7/17
C815	4030017460	S.CER ECJ0EB1E102K	T	20.3/12.5
C816	4030017460	S.CER ECJ0EB1E102K	T	15.1/10.8
C817	4030017730	S.CER ECJ0EB1E471K	T	19/9
C824	4030017590	S.CER ECJ0EC1H070C	T	13/13
C825	4030017380	S.CER ECJ0EC1H050B	T	14.2/13.4
C826	4030017570	S.CER ECJ0EC1H040B	T	13/15.1
C827	4030017620	S.CER ECJ0EC1H100C	T	14.6/15.5
C828	4030017360	S.CER ECJ0EC1H030B	T	13.9/16.4
C829	4030017660	S.CER ECJ0EC1H330J	T	12.7/16.9
C830	4030017570	S.CER ECJ0EC1H040B	T	11.8/17.6
C831	4030017570	S.CER ECJ0EC1H040B	T	11.8/19.2
C832	4030017590	S.CER ECJ0EC1H070C	T	10.3/19.1
C833	4030017610	S.CER ECJ0EC1H090C	T	8.4/19.1
C834	4030017350	S.CER ECJ0EC1H020B	T	8/17.9
C835	4030017580	S.CER ECJ0EC1H060C	T	7/19.5
C838	4030017460	S.CER ECJ0EB1E102K	T	5.3/19.5
C839	4030017780	S.CER ECJ0EB1E472K	T	25.4/14.5
C840	4030017460	S.CER ECJ0EB1E102K	T	6.5/15.6
C841	4030006860	S.CER C1608 JB 1H 102K-T	B	5.1/15.3
C851	4030017780	S.CER ECJ0EB1E472K	T	4.5/14
C901	4030017780	S.CER ECJ0EB1E472K	T	2.4/68.4
C902	4030017430	S.CER ECJ0EC1H101J	T	16/53.2
C951	4030016930	S.CER ECJ0EB1A104K	T	52.3/38.2
C952	4030011600	S.CER C1608 JB 1E 104K-T	T	58.3/46.9
C953	4030016930	S.CER ECJ0EB1A104K	T	54/18.3
C954	4030017780	S.CER ECJ0EB1E472K	T	54.1/28.1
C955	4030016930	S.CER ECJ0EB1A104K	T	52.8/33.2
C956	4030016930	S.CER ECJ0EB1A104K	T	49.2/21
C957	4030016930	S.CER ECJ0EB1A104K	T	53.8/35.9
C958	4030017780	S.CER ECJ0EB1E472K	T	52.8/34.1
C959	4030017780	S.CER ECJ0EB1E472K	T	52.8/35
C960	4030016930	S.CER ECJ0EB1A104K	T	53.5/38.9
C961	4030016930	S.CER ECJ0EB1A104K	T	52.3/39.8
C962	4030016930	S.CER ECJ0EB1A104K	T	52.3/44.6
C963	4030016930	S.CER ECJ0EB1A104K	T	53.5/38
C964	4030017460	S.CER ECJ0EB1E102K	T	55/44.8
C966	4030016930	S.CER ECJ0EB1A104K	T	52.3/41.4
C967	4030016930	S.CER ECJ0EB1A104K	T	52.3/43
C968	4030018960	S.CER C3216 JB 1C 106MT-N	B	42/43.9
C969	4030006880	S.CER C1608 JB 1H 472K-T	B	48.2/23.1
C972	4030018970	S.CER C3225 JB 1C 226MT-N	B	42.2/3.5
C973	4030018970	S.CER C3225 JB 1C 226MT-N	B	29/2.7
C974	4030018970	S.CER C3225 JB 1C 226MT-N	B	32/2.7
C975	4550007140	S.TAN TEESVD 1C 107M12R	B	16.7/4.1
C976	4550007140	S.TAN TEESVD 1C 107M12R	B	23.5/10.5
C977	4550007140	S.TAN TEESVD 1C 107M12R	B	23.5/19.5
C978	4550007140	S.TAN TEESVD 1C 107M12R	B	32.3/10.5
C980	4030004720	S.CER C2012 JB 1H 102K-T	B	55.5/11
C981	4030016930	S.CER ECJ0EB1A104K	T	54.4/12.5
C982	4030006860	S.CER C1608 JB 1H 102K-T	B	14/67.1
C983	4030006860	S.CER C1608 JB 1H 102K-T	B	7.4/74
C991	4030006860	S.CER C1608 JB 1H 102K-T	B	10/68.1
C992	4030006860	S.CER C1608 JB 1H 102K-T	B	7.2/67.3
C993	4030006860	S.CER C1608 JB 1H 102K-T	B	4.2/74
C994	4030006860	S.CER C1608 JB 1H 102K-T	B	5.6/71.3
C995	4030006860	S.CER C1608 JB 1H 102K-T	B	2.2/59.2
C996	4030006860	S.CER C1608 JB 1H 102K-T	B	5/58.8
C997	4030006860	S.CER C1608 JB 1H 102K-T	B	2.9/55
C998	4030006860	S.CER C1608 JB 1H 102K-T	B	3.1/62.6
C1001	4030011600	S.CER C1608 JB 1E 104K-T	T	58.3/48.4
C1051	4030006880	S.CER C1608 JB 1H 472K-T	B	20.2/65.3
C1052	4030006880	S.CER C1608 JB 1H 472K-T	B	19.2/60.3
C1101	4030017780	S.CER ECJ0EB1E472K	T	38.9/52.1
C1102	4030017780	S.CER ECJ0EB1E472K	T	44.2/50.3
C1104	4030017780	S.CER ECJ0EB1E472K	T	42.2/62.2
C1105	4030017780	S.CER ECJ0EB1E472K	T	40.6/59.9
C1106	4030017780	S.CER ECJ0EB1E472K	T	40.4/55.9
C1107	4030017780	S.CER ECJ0EB1E472K	T	43.3/56.9
C1108	4030017460	S.CER ECJ0EB1E102K	T	40.1/62.2
C1109	4030006880	S.CER C1608 JB 1H 472K-T	B	35.1/76.9
C1110	4030017780	S.CER ECJ0EB1E472K	T	33.5/59.6
C1111	4030017780	S.CER ECJ0EB1E472K	T	29.7/59.6
C1112	4030017780	S.CER ECJ0EB1E472K	T	38.2/63.4
C1113	4030017780	S.CER ECJ0EB1E472K	T	37.1/59.7
C1114	4030017780	S.CER ECJ0EB1E472K	T	24.4/60.6
C1115	4030017780	S.CER ECJ0EB1E472K	T	35.3/59.8
C1116	4030017460	S.CER ECJ0EB1E102K	T	23.1/63.7
C1117	4030006860	S.CER C1608 JB 1H 102K-T	B	20.9/63.9
C1151	4030017780	S.CER ECJ0EB1E472K	T	50.5/66.3
C1152	4030017780	S.CER ECJ0EB1E472K	T	46.4/66.3
C1153	4030017780	S.CER ECJ0EB1E472K	T	43.7/68.2

[DDS UNIT]

REF NO.	PARTS NO.	DESCRIPTION	M.	H/V LOCATION
C1154	4030017780	S.CER ECJ0EB1E472K	T	52/66.3
C1155	4030017780	S.CER ECJ0EB1E472K	T	57.9/68.3
RL1101	6330001721	REL ATN207-K1		
J151	6510007020	CON TMP-J01X-V6		
J851	6510018450	CON TMP-S01X-B1		
J951	6510024880	S.CON 52689-3087	T	59.2/35.3
J952	6510024880	S.CON 52689-3087	T	59.2/12.4
J1001	6510003521	CON S04B-EH-S(LF)(SN)		
J1051	6450001791	CON HLJ7000-016010 2		
J1101	6450001641	CON TCS5044-01411177		
J1151	6450001841	CON TCS7568-4320177		
EP6	6910012350	S.BEA MMZ1608Y 102BT	B	12.9/11
EP251	6910012350	S.BEA MMZ1608Y 102BT	B	33.1/18.7
EP301	6910012350	S.BEA MMZ1608Y 102BT	B	49.7/25
EP302	6910012350	S.BEA MMZ1608Y 102BT	B	32.9/27.8
EP303	6910012350	S.BEA MMZ1608Y 102BT	B	32.9/26.1
EP305	6910012350	S.BEA MMZ1608Y 102BT	B	41/27.1
EP306	6910012350	S.BEA MMZ1608Y 102BT	B	36.6/26.3
			[EUR]	
			[FRA]	
			[ESP]	
			[USA]	
			[EXP]	
			[ITR]	
			[KOR]	
			[AUS]	
			[CHN]	
EP451	6910012350	S.BEA MMZ1608Y 102BT	B	39.9/47.8
EP809	6910012350	S.BEA MMZ1608Y 102BT	B	16.6/7.1
EP951	6910012350	S.BEA MMZ1608Y 102BT	B	53.3/24.3
EP952	6910012350	S.BEA MMZ1608Y 102BT	B	50.5/21.7
EP953	6910012350	S.BEA MMZ1608Y 102BT	T	54/43.4
EP954	6910012350	S.BEA MMZ1608Y 102BT	T	54/42.1
EP955	6910012350	S.BEA MMZ1608Y 102BT	T	54.2/40
EP956	6910012350	S.BEA MMZ1608Y 102BT	T	54.6/37
EP957	6910012350	S.BEA MMZ1608Y 102BT	B	39.5/46.1
EP958	6910012350	S.BEA MMZ1608Y 102BT	B	55.9/47.4
EP959	6910012350	S.BEA MMZ1608Y 102BT	B	56.7/32.5
EP960	6910012350	S.BEA MMZ1608Y 102BT	B	56.9/28.4
EP964	6910012350	S.BEA MMZ1608Y 102BT	B	53.3/22.2
EP981	6910012350	S.BEA MMZ1608Y 102BT	T	55.3/14.2
EP1003	6910018930	S.BEA MPZ2012S601A	T	57.2/50.3
EP1004	6910018930	S.BEA MPZ2012S601A	T	53.9/50
EP1051	6910012350	S.BEA MMZ1608Y 102BT	B	20.2/66.8
EP1052	6910012350	S.BEA MMZ1608Y 102BT	B	19.2/58.7
EP1100	6910012350	S.BEA MMZ1608Y 102BT	B	38.7/63.4
EP1101	6910012350	S.BEA MMZ1608Y 102BT	T	27.5/63.3
EP1102	6910012350	S.BEA MMZ1608Y 102BT	T	34.4/62.4
EP1103	6910012350	S.BEA MMZ1608Y 102BT	T	51.1/69.2
EP1104	6910012350	S.BEA MMZ1608Y 102BT	T	56.1/69.2
EP1105	6910014730	S.BEA MPZ2012S331A-T	B	41/67.9
EP1106	6910014730	S.BEA MPZ2012S331A-T	B	34.7/61.8
EP1107	6910014730	S.BEA MPZ2012S331A-T	B	31.4/61.8
EP1108	6910014730	S.BEA MPZ2012S331A-T	B	27/73.6
MP201	85100017200	PLA 2427 A-SHIELD PLATE Y800	B	43/14.7

M.=Mounted side (T: Mounted on the Top side, B: Mounted on the Bottom side)
S.=Surface mount

BOARD LAYOUTS

The combination of this side and the bottom side shows the board layout in the same configuration as the actual P.C.Board.

• LOGIC UNIT (TOP VIEW)

J2101		
1	3V	EMU 2
	GND	TMS
	GND	TCK
	TDO	TRST
9	GND	TDI 10

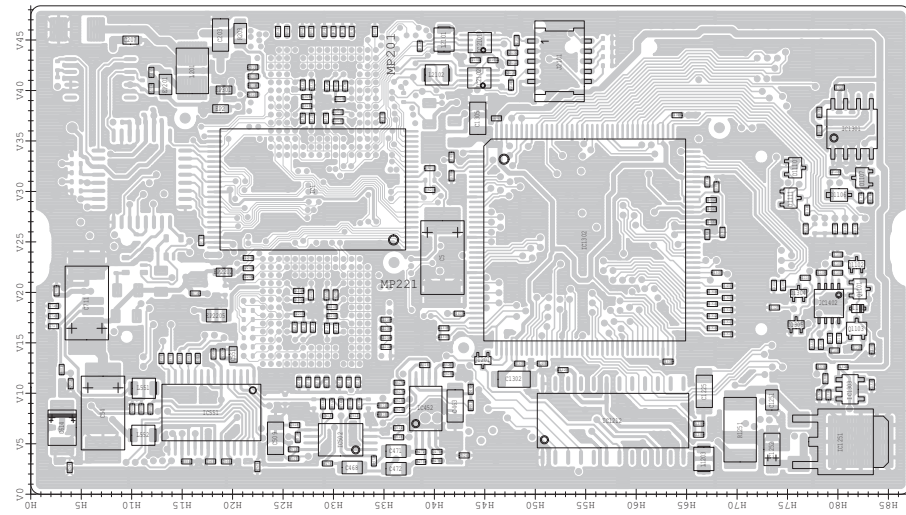

• PA UNIT (TOP VIEW)

J980		
1	FDAT	GND
2	MCK	PRES
	MST	GND
	3R3V	HFOR
	GND	HREF
	NC	P2R8
	AT13	P4R8
	THER	PR4S
	TB1V	PR3S
	TB2V	2M8L
	PHT8	VUFOR
	PT8V	PT8V
	ID4V	P4T8
28	IDRV	P2T8

J2		
1	ID1V	14V
	HCR8	14V
	ICH	14V
	ICI	14V
	GND	14V
	GND	14V
	GND	14V
	GND	14V
	GND	14V
	GND	14V
	8V	14V
	8V	14V
	14V	14V
	14V	14V
	14V	14V
	14V	14V
2		28

to MAIN unit J2004

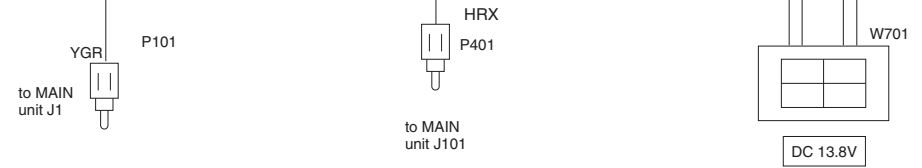
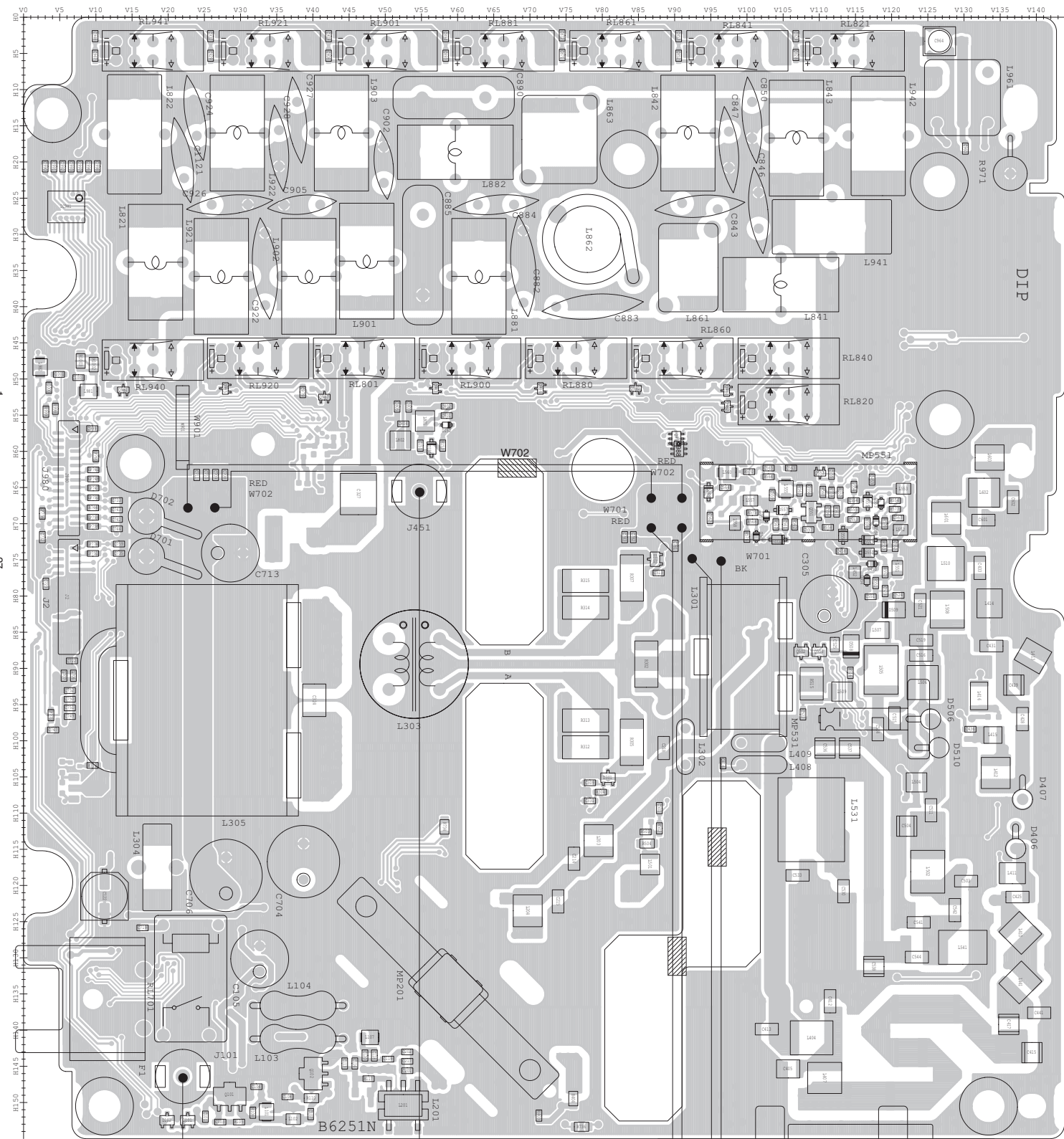

The combination of this side and the bottom side shows the board layout in the same configuration as the actual P.C.Board.

• PA UNIT
(BOTTOM VIEW)

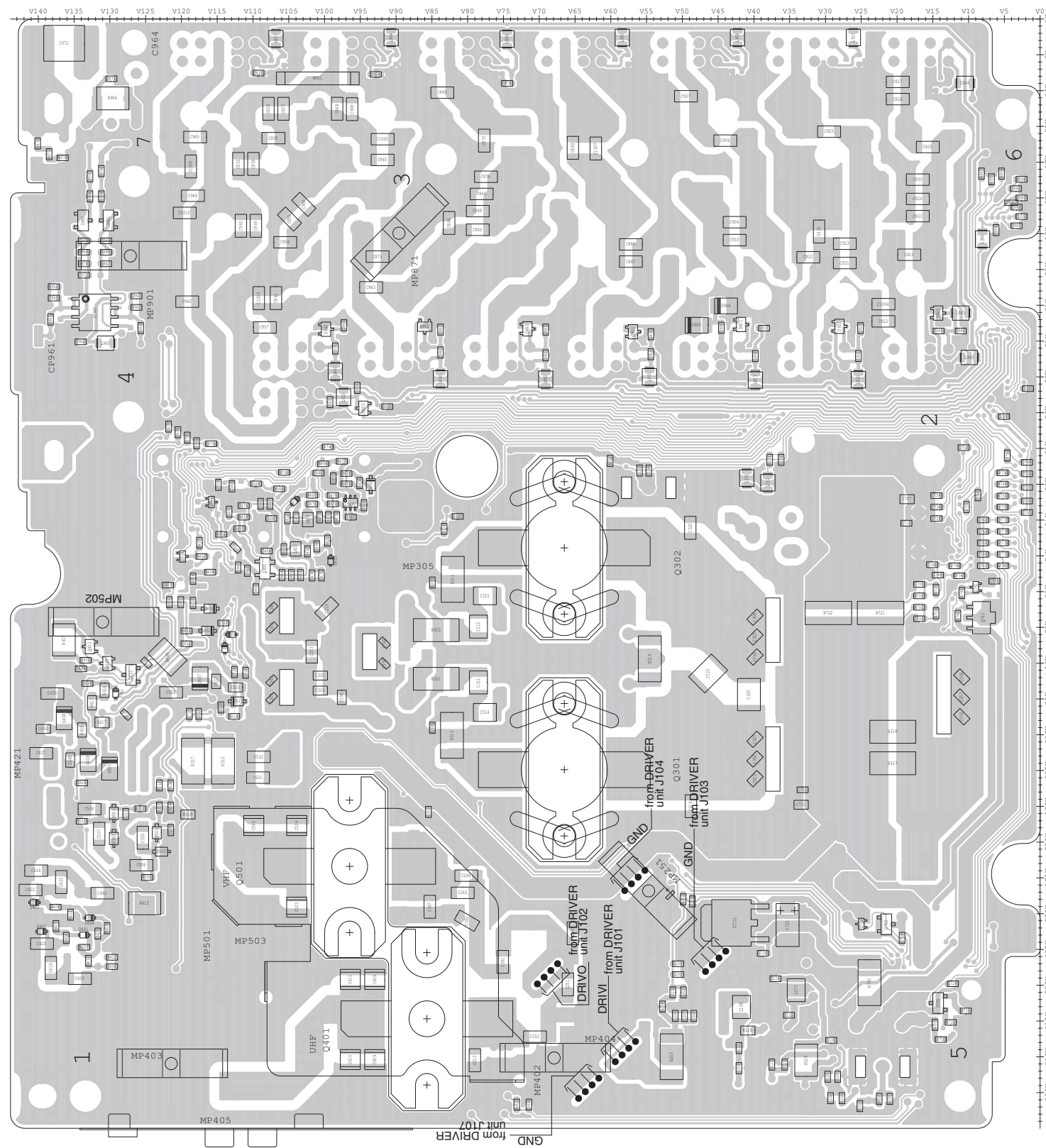

• LOGIC UNIT
(BOTTOM VIEW)

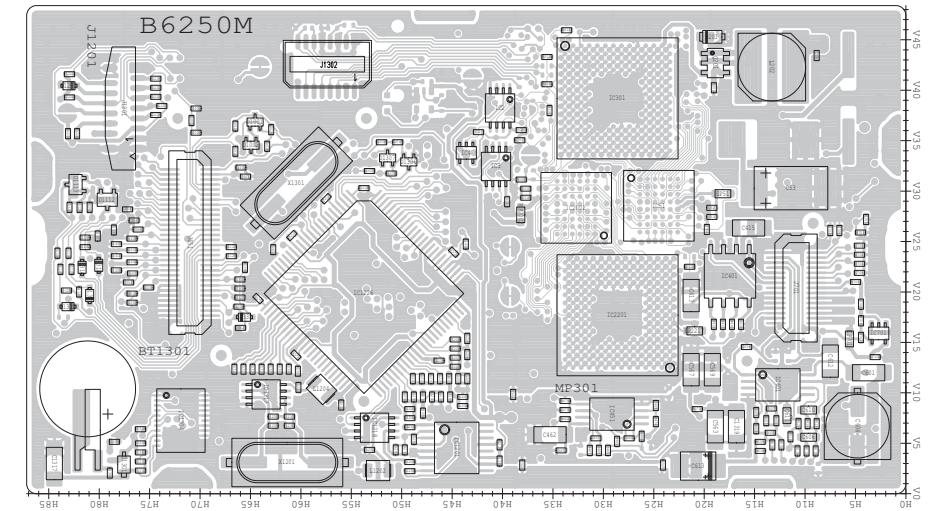

J651

60	1DST	VDL	1
	3DST	MMDK	
	PDT	SQSS	
	PCK	DOTK	
	TCNO	DASK	
	TCN1	WFML	
	PRES#	LTXD	
	LOST	LRXD	
	RS_RXD	CIV	
	RS_TXD	CIVE	
	MST	START	
	MDT	KEY	
	MCK	MUDL	
	NC	FORL	
	SNDS	REFL	
	SDSS	ALCL	
	2T8V	SNDL	
	4T8V	DPTL	
	TXS	THML	
	RXS	CPU_P12	
	POWS	RTKI	
	VOUT	CPU_P22	
	PWRK	CPU_P94	
	GND	CPU_P95	
	GND	IMR	
	GND	CPU_PF6	
	GND	MMSL	
	GND	NC	
	GND	IMR2	
31	GND	NC	30

to MAIN unit J2252

J701

15	GND	AFMS	16
	DSP02	MOSI	
	GND	SKC	
	DSP01	VSTB	
	GND	NC	
	DOUT	NC	
	GND	NC	
	NC	24M	
	GND	HV	
	GND	8V	
	GND	8V	
	GND	5V	
	DSP1	5V	
	GND	3V	
1	DSP12	3V	30

to MAIN unit J2251

• LOGIC UNIT (1/3)

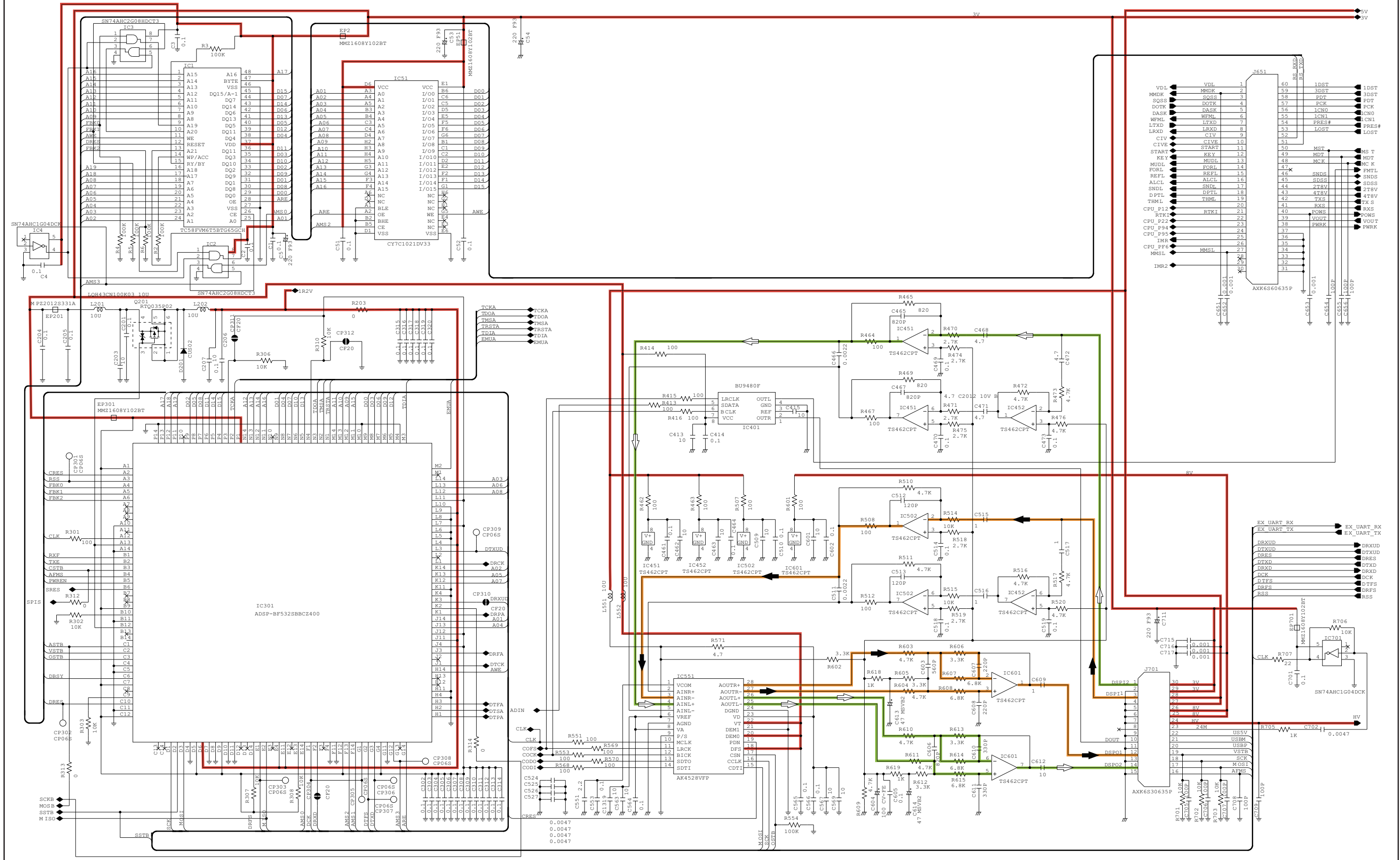

*; Refer to "PARTS LIST"

• LOGIC UNIT (3/3)

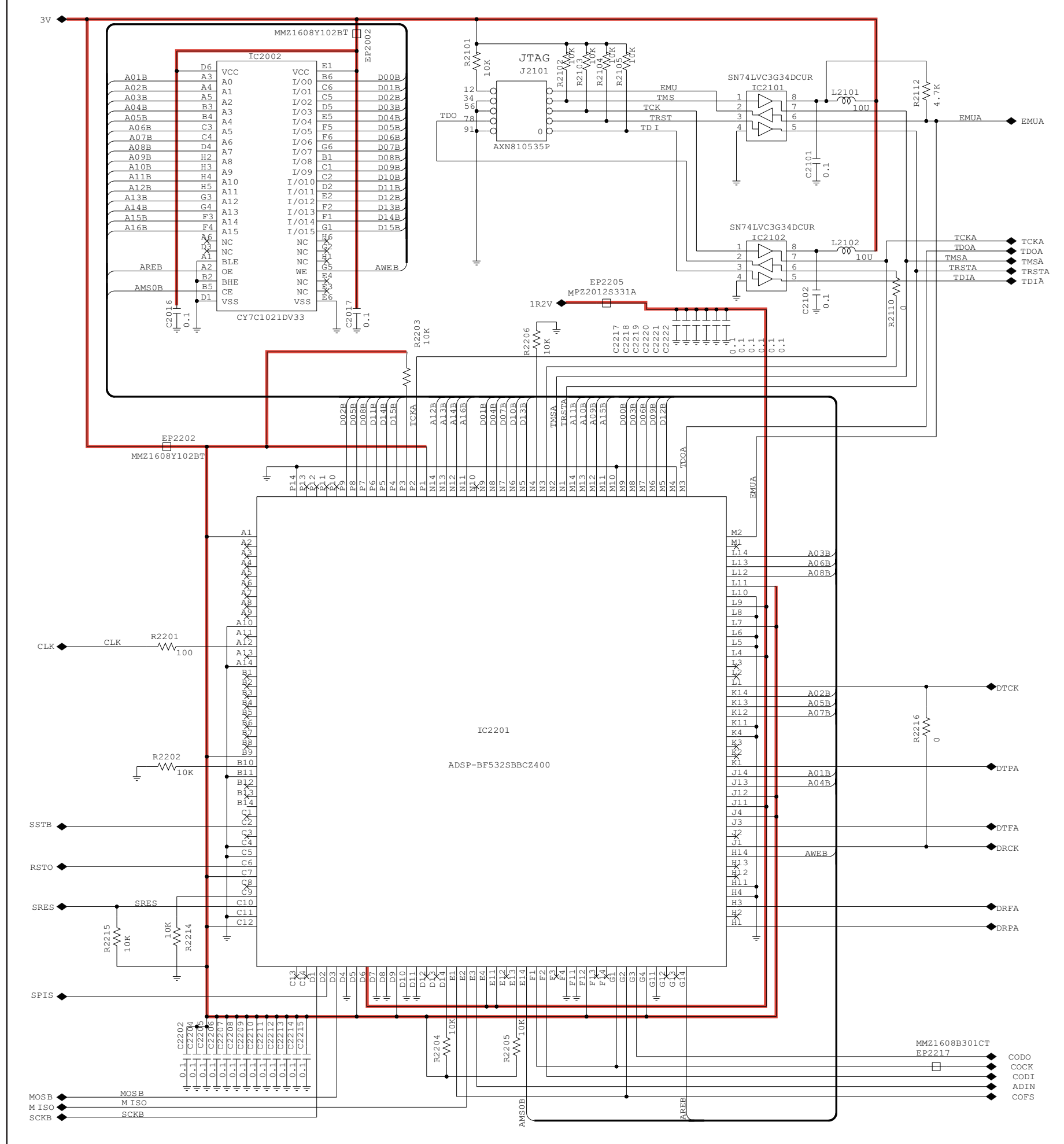

*; Refer to "PARTS LIST."

Oct. 2008



SERVICE MANUAL ADDENDUM

IC-7000

CONTENTS

PARTS LIST	1
BOARD LAYOUTS	26
VOLTAGE DIAGRAM	32

PARTS LIST

[MAIN UNIT]

REF NO.	PARTS NO.	DESCRIPTION	M.	H/V LOCATION	
IC401	1190002052	S.IC SPM5001-TL-E (7000)2 [EUR]	T	77.5/27.9	
	1190002052	S.IC SPM5001-TL-E (7000)2 [ESP]	T		
	1190002052	S.IC SPM5001-TL-E (7000)2 [USA]	T		
	1190002052	S.IC SPM5001-TL-E (7000)2 [EXP]	T		
	1190002052	S.IC SPM5001-TL-E (7000)2 [ITR]	T		
	1190002052	S.IC SPM5001-TL-E (7000)2 [UK]	T		
	1190002052	S.IC SPM5001-TL-E (7000)2 [CHN]	T		
	IC1	1110004080	S.IC UPC2709T-E3	T	75.6/12.7
	IC2	1110004101	S.IC TA4001F (TE85L,F)	T	64/18.8
	IC3	1110004091	S.IC TA4002F (TE85L,F)	T	48.3/17.4
IC401	1190002051	S.IC SPM5001-TL-E 1 [FRA]	T	77.5/27.9	
	1190002051	S.IC SPM5001-TL-E 1 [KOR]	T		
	1190002051	S.IC SPM5001-TL-E 1 [AUS]	T		
IC421	1110004080	S.IC UPC2709T-E3	T	86.4/19.4	
IC801	1110004080	S.IC UPC2709T-E3	T	86/57.4	
IC1101	1110006730	S.IC NJM2594V-TE1-#ZZZB	T	5/83.3	
IC1201	1130006221	S.IC TC4W53FU(TE12L,F)	T	24.2/81.6	
IC1202	1130006221	S.IC TC4W53FU(TE12L,F)	T	19.8/81.4	
IC1203	1110006570	S.IC TS462CPT	T	12.8/81.7	
IC1301	1110005461	S.IC TA4107F(TE12L,F)	T	13.7/63.4	
IC1401	1110006541	S.IC LA1225M-TLM-E	B	23.4/82.2	
IC1501	1110006530	S.IC TA4019F(TE12L,F)	B	74.8/39	
IC1502	1110005040	S.IC M52342FP 600C	B	79.7/57	
IC1601	1110005320	S.IC NJM13403V-TE1-#ZZZB	T	8.6/41.5	
IC1801	1180002020	S.REG BA033FP-E2	B	22.8/106.5	
IC1901	1180001251	S.IC TA7808F(TE16L,Q)	B	10.4/55.2	
IC1951	1190002120	S.IC XC9201D09AKR	B	41.9/107.8	
IC1952	1180002020	S.REG BA033FP-E2	B	14.7/125.8	
IC2001	1180001251	S.IC TA7808F(TE16L,Q)	B	8.5/19	
IC2007	1110006570	S.IC TS462CPT	T	15.8/121	
IC2101	1110005320	S.IC NJM13403V-TE1-#ZZZB	T	28.5/118	
IC2102	1110005320	S.IC NJM13403V-TE1-#ZZZB	T	49.5/111.9	
IC2103	1110005140	S.IC NJM3403AV-TE1-#ZZZB	T	49.5/121.2	
IC2151	1130012720	S.IC CD74HC4094PWR	T	47.1/95.9	
IC2152	1130012720	S.IC CD74HC4094PWR	T	37.9/95.9	
IC2153	1130012720	S.IC CD74HC4094PWR	T	28.1/95.8	
IC2154	1130012720	S.IC CD74HC4094PWR	T	28.2/101.5	
IC2155	1110006680	S.IC BH2211FV-E2	T	38.2/118.1	
IC2156	1130009100	S.IC BU4052BCFV-E2	T	10.1/107.6	
IC2231	1110006640	S.IC NJM2244M-TE1-#ZZZB	T	34.7/109.4	
IC2251	1130008511	S.IC TC7W53FU(TE12L,F)	T	16.7/89.5	
IC2501	1110006570	S.IC TS462CPT	B	12.7/91.7	
IC2551	1110006570	S.IC TS462CPT	B	49.2/122	
IC2601	1130006221	S.IC TC4W53FU(TE12L,F)	B	63.2/123.9	
IC2602	1110003091	IC LA4425A-E			
Q101	1530003091	S.TRA 2SC4213-B(TE85R,F)	T	11.2/17.5	
Q102	1590003940	S.TRA RN1105(TE85L,F)	T	20.7/5.6	
Q103	1590003930	S.TRA UMD22N TR	T	38.4/20.2	
Q201	1590003940	S.TRA RN1105(TE85L,F)	T	16.1/31.1	
Q202	1590003940	S.TRA RN1105(TE85L,F)	T	23.5/28.5	
Q204	1590003940	S.TRA RN1105(TE85L,F)	B	44.7/38.6	
Q205	1590003940	S.TRA RN1105(TE85L,F)	T	42.9/61.5	
Q206	1590003940	S.TRA RN1105(TE85L,F)	B	24.5/55	
Q207	1590003940	S.TRA RN1105(TE85L,F)	B	24.5/51.9	
Q208	1590003940	S.TRA RN1105(TE85L,F)	B	24.2/48.8	
Q209	1590003940	S.TRA RN1105(TE85L,F)	B	23.5/45.7	
Q210	1590003940	S.TRA RN1105(TE85L,F)	B	42.9/41.4	
Q211	1530003851	S.TRA 2SC5551F-TD-E 0	T	27.6/30.1	
Q301	1530003851	S.TRA 2SC5551F-TD-E 0	T	56.7/32.4	
Q402	1590003930	S.TRA UMD22N TR	T	82.8/22.8	
Q403	1590003930	S.TRA UMD22N TR	T	69.7/23.6	
Q502	1530003851	S.TRA 2SC5551F-TD-E 0	T	83/37.1	
Q701	1580000780	S.FET 3SK195(TE85L,F)	T	62/56.5	
Q702	1580000780	S.FET 3SK195(TE85L,F)	T	54.6/51.8	
Q901	1580000780	S.FET 3SK195(TE85L,F)	T	36.6/65.7	
Q902	1580000780	S.FET 3SK195(TE85L,F)	T	35.9/73.2	
Q1001	1580000780	S.FET 3SK195(TE85L,F)	T	17.9/76	
Q1201	1590003930	S.TRA UMD22N TR	T	28/78.6	
Q1401	1530002060	S.TRA 2SC4081 T106 R	B	42.5/74.3	
Q1402	1530002060	S.TRA 2SC4081 T106 R	B	36.7/80.1	
Q1501	1590003530	S.TRA BCR08PN 0	T	30.6/78.5	
Q1521	1530002060	S.TRA 2SC4081 T106 R	B	86.6/48.6	
Q1601	1530003091	S.TRA 2SC4213-B(TE85R,F)	T	8.3/52.9	
Q1602	1590001870	S.TRA DTA114EE TL	T	4.5/53	
Q1603	1590003940	S.TRA RN1105(TE85L,F)	T	2.8/40.7	
Q1604	1510000771	S.TRA 2SA1586-GR(TE85L,F)	T	5.1/32.7	
Q1606	1560001260	S.FET 2SK3018 T106	T	12.5/36.8	
Q1701	1540000441	S.TRA 2SD1619T-TD-E	B	52.4/48.2	
Q1702	1590003940	S.TRA RN1105(TE85L,F)	B	54.3/52.1	
Q1703	1540000441	S.TRA 2SD1619T-TD-E	B	52.4/67.4	
Q1704	1590003940	S.TRA RN1105(TE85L,F)	B	54.1/72.9	
Q1901	1590003930	S.TRA UMD22N TR	T	35.8/78.5	
Q1902	1590003930	S.TRA UMD22N TR	T	33.3/78.5	
Q1903	1590003930	S.TRA UMD22N TR	B	23.6/17	
Q1904	1590003930	S.TRA UMD22N TR	B	32.9/87.9	
Q1905	1590003930	S.TRA UMD22N TR	B	46/40.9	
Q1906	1590003930	S.TRA UMD22N TR	B	26.3/30.8	
Q1907	1590003930	S.TRA UMD22N TR	T	40.9/78.5	
Q1908	1590003930	S.TRA UMD22N TR	T	38.3/78.5	
Q1909	1590003930	S.TRA UMD22N TR	B	22.1/11.8	
Q1960	1550000090	S.FET RSQ035P03TR	B	37.9/103.6	

[MAIN UNIT]

REF NO.	PARTS NO.	DESCRIPTION	M.	H/V LOCATION
Q2150	1590003930	S.TRA UMD22N TR	T	48.4/100.1
Q2151	1520000460	S.TRA 2SB1132 T100 R	T	55.3/103.8
Q2152	1520000460	S.TRA 2SB1132 T100 R	T	21.3/111
Q2153	1520000460	S.TRA 2SB1132 T100 R	T	49.8/104.5
Q2154	1590003930	S.TRA UMD22N TR	T	44.7/100.1
Q2155	1590003930	S.TRA UMD22N TR	T	39.9/100.1
Q2156	1590003940	S.TRA RN1105(TE85L,F)	T	58.9/104.5
Q2157	1590003940	S.TRA RN1105(TE85L,F)	T	25.4/109.7
Q2158	1590003940	S.TRA RN1105(TE85L,F)	T	45.5/107.1
Q2159	1590003930	S.TRA UMD22N TR	T	6.7/118.2
Q2160	1590003930	S.TRA UMD22N TR	T	7.7/122.2
Q2231	1590003940	S.TRA RN1105(TE85L,F)	T	4.7/121.7
Q2232	1590003930	S.TRA UMD22N TR	T	57.3/114.8
Q2233	1590003930	S.TRA UMD22N TR	T	54.7/115.7
Q2301	1530002060	S.TRA 2SC4081 T106 R	T	30.6/109
Q2401	1540000441	S.TRA 2SD1619T-TD-E	B	80.1/26.4
Q2601	1560001260	S.FET 2SK3018 T106	B	36.2/124.6
Q2602	1560001221	S.FET ECH8301-TL-E	B	37.3/127.6
Q2603	1530002060	S.TRA 2SC4081 T106 R	T	65.3/111.3
Q2605	1590003940	S.TRA RN1105(TE85L,F)	T	11.7/112.7
Q2606	1540000451	S.TRA 2SD1623T-TD-E	B	89.5/119.9
Q2607	1590003940	S.TRA RN1105(TE85L,F)	B	65.4/120.5
Q2608	1590003940	S.TRA RN1105(TE85L,F)	B	45/128.6
D1	1750000581	S.DIO 1SV307(TPH3,F)	T	70.1/16.6
D2	1750000581	S.DIO 1SV307(TPH3,F)	T	70.3/14.8
D3	1750000581	S.DIO 1SV307(TPH3,F)	T	45.2/19.8
D4	1750000581	S.DIO 1SV307(TPH3,F)	T	41.9/19
D5	1750000581	S.DIO 1SV307(TPH3,F)	T	70.3/18.3
D6	1790000620	S.DIO MA77(TX) 0	B	79.8/17.1
D7	1790000620	S.DIO MA77(TX) 0	T	78/15.8
D8	1790000620	S.DIO MA77(TX) 0	B	81.5/10.6
D9	1790000620	S.DIO MA77(TX) 0	T	79/11.5
D10	1750000581	S.DIO 1SV307(TPH3,F)	T	42.4/20.9
D101	1750000581	S.DIO 1SV307(TPH3,F)	T	13.3/25.5
D102	1750000581	S.DIO 1SV307(TPH3,F)	T	15.7/19.2
D103	1750000581	S.DIO 1SV307(TPH3,F)	T	20.3/8.7
D104	1750000581	S.DIO 1SV307(TPH3,F)	T	34.7/17.9
D105	1750000581	S.DIO 1SV307(TPH3,F)	T	23.1/12.7
D106	1750000581	S.DIO 1SV307(TPH3,F)	T	29.6/21
D107	1750000581	S.DIO 1SV307(TPH3,F)	T	44/23.6
D108	1750000950	S.DIO MA732(TX)	B	27.1/18.2
D109	1750000950	S.DIO MA732(TX)	B	24.7/20.3
D110	1790001240	S.DIO MA2S728-(TX)	B	51.6/26.4
D111	1790001240	S.DIO MA2S728-(TX)	B	51.6/24.7
D112	1750000581	S.DIO 1SV307(TPH3,F)	T	15.7/20.9
D113	1750000581	S.DIO 1SV307(TPH3,F)	T	10.2/19.7
D114	1790001250	S.DIO MA2S111-(TX)	T	35.7/21.3
D203	1750000581	S.DIO 1SV307(TPH3,F)	T	19.3/35.7
D204	1750000581	S.DIO 1SV307(TPH3,F)	T	25.7/58.2
D205	1750000581	S.DIO 1SV307(TPH3,F)	T	25.7/56.3
D208	1750000581	S.DIO 1SV307(TPH3,F)	T	25.7/53.4
D209	1750000581	S.DIO 1SV307(TPH3,F)	T	25.7/50.6
D210	1750000581	S.DIO 1SV307(TPH3,F)	T	25.7/47.7
D211	1750000581	S.DIO 1SV307(TPH3,F)	T	25.7/44.8
D212	1750000581	S.DIO 1SV307(TPH3,F)	T	25.7/39.2
D213	1750000581	S.DIO 1SV307(TPH3,F)	T	25.7/41.5
D214	1750000581	S.DIO 1SV307(TPH3,F)	T	47.7/59.3
D215	1750000581	S.DIO 1SV307(TPH3,F)	T	47.7/56.3
D216	1750000581	S.DIO 1SV307(TPH3,F)	T	47.9/53.6
D217	1750000581	S.DIO 1SV307(TPH3,F)	T	47.8/49.7
D218	1750000581	S.DIO 1SV307(TPH3,F)	B	41.7/47.2
D219	1750000581	S.DIO 1SV307(TPH3,F)	B	38.9/41.6
D220	1750000581	S.DIO 1SV307(TPH3,F)	B	44.6/28.5
D221	1750000581	S.DIO 1SV307(TPH3,F)	B	40.4/36
D301	1750000581	S.DIO 1SV307(TPH3,F)	T	47.3/28.5
D302	1750000581	S.DIO 1SV307(TPH3,F)	T	49.5/30.3
D303	1750000581	S.DIO 1SV307(TPH3,F)	T	64.1/29.9
D304	1750000581	S.DIO 1SV307(TPH3,F)	T	62.4/35.2
D305	1750000581	S.DIO 1SV307(TPH3,F)	T	73.3/35.2
D306	1750000581	S.DIO 1SV307(TPH3,F)	T	64.5/25.7
D401	1790001240	S.DIO MA2S728-(TX)	T	86.6/24.9
D501	1750000531	S.DIO 1SV271(TPH3,F)	T	90.6/32.2
D502	1750000581	S.DIO 1SV307(TPH3,F)	T	86.2/31.4
D503	1750000581	S.DIO 1SV307(TPH3,F)	T	89.4/29.7
D504	1750000531	S.DIO 1SV271(TPH3,F)	T	89.7/37.7
D505	1750000581	S.DIO 1SV307(TPH3,F)	T	86.7/40.1
D506	1750000581	S.DIO 1SV307(TPH3,F)	B	87.2/35.5
D601	1750000581	S.DIO 1SV307(TPH3,F)	B	90/38.5
D602	1750000581	S.DIO 1SV307(TPH3,F)	T	92.4/41.5
D603	1750000581	S.DIO		

[MAIN UNIT]

REF NO.	PARTS NO.	DESCRIPTION	M.	H/V LOCATION
D1302	1750000581	S.DIO 1SV307(TPH3,F)	T	13.9/70.8
D1521	1750000531	S.DIO 1SV271(TPH3,F)	B	79.4/40.7
D1522	1750000531	S.DIO 1SV271(TPH3,F)	B	79.4/42.4
D1601	1790001240	S.DIO MA2S728-(TX)	T	15.1/48.7
D1602	1790001240	S.DIO MA2S728-(TX)	T	18.3/53.1
D1604	1790001250	S.DIO MA2S111-(TX)	T	7.7/31.5
D1605	1790001250	S.DIO MA2S111-(TX)	T	7.7/32.8
D1606	1790001250	S.DIO MA2S111-(TX)	T	14.1/44.8
D1607	1790001250	S.DIO MA2S111-(TX)	T	14.1/43.5
D1608	1790001250	S.DIO MA2S111-(TX)	T	14.1/42.2
D1609	1790001330	S.ZEN MA8036-L(TX)	T	7.5/29.9
D1610	1790001250	S.DIO MA2S111-(TX)	T	12.3/34.9
D1701	1790001670	S.DIO RB706F-40T106	B	50.2/52.2
D1702	1790001670	S.DIO RB706F-40T106	B	51.8/71.8
D1951	1750001110	S.DIO SM240A-T	B	36.2/99.9
D2151	1790001250	S.DIO MA2S111-(TX) [USA]	T	39/87.1
	1790001250	S.DIO MA2S111-(TX) [KOR]		
	1790001250	S.DIO MA2S111-(TX) [AUS]		
D2153	1790001250	S.DIO MA2S111-(TX) [USA]	T	36.5/87.1
	1790001250	S.DIO MA2S111-(TX) [KOR]		
D2154	1790001250	S.DIO MA2S111-(TX)	T	36.5/88.4
D2155	1790001250	S.DIO MA2S111-(TX)	T	36.6/89.7
D2156	1790001250	S.DIO MA2S111-(TX)	T	39/90.5
D2157	1790001250	S.DIO MA2S111-(TX) [EUR]	T	48.5/87.1
	1790001250	S.DIO MA2S111-(TX) [ESP]		
	1790001250	S.DIO MA2S111-(TX) [USA]		
	1790001250	S.DIO MA2S111-(TX) [EXP]		
	1790001250	S.DIO MA2S111-(TX) [ITR]		
	1790001250	S.DIO MA2S111-(TX) [UK]		
	1790001250	S.DIO MA2S111-(TX) [KOR]		
	1790001250	S.DIO MA2S111-(TX) [AUS]		
	1790001250	S.DIO MA2S111-(TX) [CHN]		
D2158	1790001250	S.DIO MA2S111-(TX)	T	48.5/88.4
D2159	1790001250	S.DIO MA2S111-(TX)	T	48.5/89.7
D2160	1790001250	S.DIO MA2S111-(TX)	T	48.5/91
D2162	1790001250	S.DIO MA2S111-(TX) [USA] only	T	46/88.4
D2163	1790001250	S.DIO MA2S111-(TX) [EUR]	T	46/89.7
	1790001250	S.DIO MA2S111-(TX) [FRA]		
	1790001250	S.DIO MA2S111-(TX) [ESP]		
	1790001250	S.DIO MA2S111-(TX) [ITR]		
	1790001250	S.DIO MA2S111-(TX) [UK]		
D2166	1790001250	S.DIO MA2S111-(TX) [ESP]	T	29.4/88.2
	1790001250	S.DIO MA2S111-(TX) [ITR]		
	1790001250	S.DIO MA2S111-(TX) [KOR]		
D2168	1790001250	S.DIO MA2S111-(TX) [EUR]	T	29.4/90.6
	1790001250	S.DIO MA2S111-(TX) [ESP]		
	1790001250	S.DIO MA2S111-(TX) [ITR]		
	1790001250	S.DIO MA2S111-(TX) [UK]		
	1790001250	S.DIO MA2S111-(TX) [AUS]		
D2169	1790001250	S.DIO MA2S111-(TX) [EUR]	T	26.9/87.1
	1790001250	S.DIO MA2S111-(TX) [ESP]		
	1790001250	S.DIO MA2S111-(TX) [USA]		
	1790001250	S.DIO MA2S111-(TX) [EXP]		
	1790001250	S.DIO MA2S111-(TX) [ITR]		
	1790001250	S.DIO MA2S111-(TX) [UK]		
	1790001250	S.DIO MA2S111-(TX) [KOR]		
	1790001250	S.DIO MA2S111-(TX) [CHN]		
D2170	1790001250	S.DIO MA2S111-(TX) [EUR]	T	26.9/88.4
	1790001250	S.DIO MA2S111-(TX) [USA]		
	1790001250	S.DIO MA2S111-(TX) [EXP]		
	1790001250	S.DIO MA2S111-(TX) [UK]		
	1790001250	S.DIO MA2S111-(TX) [AUS]		
	1790001250	S.DIO MA2S111-(TX) [KOR]		
	1790001250	S.DIO MA2S111-(TX) [CHN]		
D2171	1790001250	S.DIO MA2S111-(TX) [FRA]	T	26.9/89.7
	1790001250	S.DIO MA2S111-(TX) [ESP]		
	1790001250	S.DIO MA2S111-(TX) [EXP]		
	1790001250	S.DIO MA2S111-(TX) [UK]		
	1790001250	S.DIO MA2S111-(TX) [AUS]		
	1790001250	S.DIO MA2S111-(TX) [CHN]		
D2172	1790001250	S.DIO MA2S111-(TX)	T	26.9/91
D2173	1790001250	S.DIO MA2S111-(TX)	T	6.4/120.2
D2174	1790001250	S.DIO MA2S111-(TX)	T	52/88.2
D2175	1790001250	S.DIO MA2S111-(TX)	T	52/87
D2201	1730002340	S.ZEN MA8047-M(TX)	T	10.5/122.8
D2205	1790001010	S.ZEN MA8043-L(TX)	T	13.5/115.2
D2211	1790001010	S.ZEN MA8043-L(TX)	T	21.5/118
D2231	1160000070	S.DIO DAN202K T146	T	57.6/117.8
D2232	1790001670	S.DIO RB706F-40T106	T	56.8/112.2
D2401	1160000070	S.DIO DAN202K T146	B	85.7/27.2
D2402	1790001250	S.DIO MA2S111-(TX)	T	63.5/113.2
D2551	1790001140	S.ZEN MA8039-L(TX)	B	45.3/116.5
D2601	1160000070	S.DIO DAN202K T146	B	42/126.3
D2602	1790001250	S.DIO MA2S111-(TX)	B	41.2/128.5
FI2	2040001420	S.LC LFB32440MSC1-955 (LFSC25N12B0)	T	59.3/13.9
FI3	2040001420	S.LC LFB32440MSC1-955 (LFSC25N12B0)	T	53.3/13.4
FI601	2010002640	S.XTA DSF753SDF 124.487 MHz (FL-374)	T	81/43.7
FI901	2020002011	S.CER CFUKG455KF4A-R0	T	44.7/69.7
FI1001	2020002011	S.CER CFUKG455KF4A-R0	T	27.8/66.9
FI1401	2020001810	S.CER SFECV10M7FA00-R0 (SFECV10.7MA5S)	B	37.5/76.4
FI1402	2020001810	S.CER SFECV10M7FA00-R0 (SFECV10.7MA5S)	B	29.5/77.5
FI1501	2040001561	SAW TSB6321DL [EUR]		
	2040001561	SAW TSB6321DL [FRA]		
	2040001561	SAW TSB6321DL [ESP]		

[MAIN UNIT]

REF NO.	PARTS NO.	DESCRIPTION	M.	H/V LOCATION
FI1501	2040001571	SAW TSB6221DL [USA]		
	2040001561	SAW TSB6321DL [EXP]		
	2040001561	SAW TSB6321DL [ITR]		
	2040001561	SAW TSB6321DL [UK]		
	2040001571	SAW TSB6221DL [KOR]		
	2040001561	SAW TSB6321DL [AUS]		
	2040001561	SAW TSB6321DL [CHN]		
FI1502	2020001720	S.CER SFSKA5M50CF00-R1 (SFSCC5.5MC2-T) [EUR]	B	69.3/57.8
	2020001720	S.CER SFSKA5M50CF00-R1 (SFSCC5.5MC2-T) [FRA]		
	2020001720	S.CER SFSKA5M50CF00-R1 (SFSCC5.5MC2-T) [ESP]		
	2020001700	S.CER SFSKA4M50CF00-R1 (SFSCC4.5MC2-T) [USA]		
	2020001720	S.CER SFSKA5M50CF00-R1 (SFSCC5.5MC2-T) [EXP]		
	2020001720	S.CER SFSKA5M50CF00-R1 (SFSCC5.5MC2-T) [ITR]		
	2020001720	S.CER SFSKA5M50CF00-R1 (SFSCC5.5MC2-T) [UK]		
	2020001700	S.CER SFSKA4M50CF00-R1 (SFSCC4.5MC2-T) [KOR]		
	2020001720	S.CER SFSKA5M50CF00-R1 (SFSCC5.5MC2-T) [AUS]		
	2020001720	S.CER SFSKA5M50CF00-R1 (SFSCC5.5MC2-T) [CHN]		
FI1503	2020001730	S.CER TPSKA5M50B00-R1 (TPSCC5.5MB-TC1) [EUR]	B	73.5/78.7
	2020001730	S.CER TPSKA5M50B00-R1 (TPSCC5.5MB-TC1) [FRA]		
	2020001730	S.CER TPSKA5M50B00-R1 (TPSCC5.5MB-TC1) [ESP]		
	2020001710	S.CER TPSKA4M50B00-R1 (TPSCC4.5M0-TC1) [USA]		
	2020001730	S.CER TPSKA5M50B00-R1 (TPSCC5.5MB-TC1) [EXP]		
	2020001730	S.CER TPSKA5M50B00-R1 (TPSCC5.5MB-TC1) [ITR]		
	2020001730	S.CER TPSKA5M50B00-R1 (TPSCC5.5MB-TC1) [UK]		
	2020001710	S.CER TPSKA4M50B00-R1 (TPSCC4.5M0-TC1) [KOR]		
	2020001730	S.CER TPSKA5M50B00-R1 (TPSCC5.5MB-TC1) [AUS]		
	2020001730	S.CER TPSKA5M50B00-R1 (TPSCC5.5MB-TC1) [CHN]		
L3	6200004480	S.COI MLF1608D R82K-T	T	76.4/10.1
L4	6200002041	S.COI NLV25T-101J	T	75.6/18.9
L5	6200004780	S.COI MLF1608A 1R5K-T	T	67.4/18.6
L7	6200011320	S.COI ELJQE 56NJ 2 [AUS] only		
L8	6200010910	S.COI LQW18AN56NG00D	T	57/16.6
L10	6200010910	S.COI LQW18AN56NG00D	T	57.3/17.9
L11	6200011780	S.COI LQW18ANR18G00D	T	56.5/20
L12	6200011680	S.COI LQW18ANR12G00D	T	53.8/19.8
L13	6200011780	S.COI LQW18ANR18G00D	T	52.8/18.5
L14	6200009590	S.COI MLG1608B 18NJ-T	T	57.3/11.4
L16	6200005721	S.COI ELJRE 33NGFA [EUR]	T	49.6/19.8
	6200005721	S.COI ELJRE 33NGFA [FRA]		
	6200005721	S.COI ELJRE 33NGFA [ESP]		
	6200005721	S.COI ELJRE 33NGFA [USA]		
	6200005721	S.COI ELJRE 33NGFA [EXP]		
	6200005721	S.COI ELJRE 33NGFA [ITR]		
	6200006991	S.COI ELJRE 56NGFA [UK]		
	6200005721	S.COI ELJRE 33NGFA [KOR]		
	6200005721	S.COI ELJRE 33NGFA [AUS]		
	6200005721	S.COI ELJRE 33NGFA [CHN]		
L18	6200005041	S.COI NLV25T-220J	T	73.4/9.5
L19	6200002041	S.COI NLV25T-101J	T	66.9/14.8
L21	6200006671	S.COI ELJRE 68NGFA	B	80.4/14.6
L22	6200002861	S.COI NLV25T-4R7J	B	79.7/20.2
L23	6200002861	S.COI NLV25T-4R7J	B	84/9.2
L24	6200011520	S.COI SLF7045T-102MR14-PF	B	8.8/69
L101	6200002041	S.COI NLV25T-101J	T	15.7/17
L102	6200002041	S.COI NLV25T-101J	T	20.4/10.9
L103	6200010800	S.COI C2520C-4R7G-A	T	24.4/7.4
L104	6200010800	S.COI C2520C-4R7G-A	T	27.9/10
L105	6200002041	S.COI NLV25T-101J	T	28.1/12.8
L106	6200002041	S.COI NLV25T-101J	B	17.5/16.3
L107	6200002041	S.COI NLV25T-101J	B	31.6/21.6
L108	6200002041	S.COI NLV25T-101J	T	25.2/20.8
L109	6200001831	S.COI NLV32T-100J	T	28.5/15.6
L110	6200003121	S.COI NLV32T-8R2J	T	21.1/15.1
L112	6200002041	S.COI NLV25T-101J	B	43.5/23
L113	6200002041	S.COI NLV25T-101J	T	7.2/17.6
L114	6200002041	S.COI NLV25T-101J	T	7.2/15
L116	6200003131	S.COI NLV32T-120J	T	28.5/18.6
L117	6200001831	S.COI NLV32T-100J	T	21.1/18.1
L204	6200002041	S.COI NLV25T-101J	T	18.7/32.9
L205	6200010740	S.COI C2520C-R27G-A	T	20.2/38.1
L207	6200010680	S.COI C2520C-R22G-A (0.22U)	T	21.8/41.3
L213	6200005011	S.COI NLV25T-100J	T	22.7/34.9
L215	6200010330	S.COI C2012C-R18G-A	B	27.7/38.6
L217	6200009990	S.COI C2012C-R22G-A	T	22.7/32.5
L218	6200005011	S.COI NLV25T-100J	B	25.6/43.3
L219	6200011050	S.COI C2012C-R12G-A	B	29/41.4
L220	6200010320	S.COI C2012C-R15G-A	B	34.1/37.9

M.=Mounted side (T: Mounted on the Top side, B: Mounted on the Bottom side) S.=Surface mount

[MAIN UNIT]

REF NO.	PARTS NO.	DESCRIPTION	M.	H/V LOCATION
L221	6200002041	S.COI NLV25T-101J	T	15.1/52.6
L222	6200002041	S.COI NLV25T-101J	T	45.6/61.4
L223	6200002041	S.COI NLV25T-101J	B	40.4/55.3
L224	6200002041	S.COI NLV25T-101J	B	27.5/55.7
L225	6200002041	S.COI NLV25T-101J	B	27.4/52
L226	6200002861	S.COI NLV25T-4R7J	T	40.3/57.6
L227	6200003711	S.COI NLV25T-2R7J	T	29.1/55.5
L228	6200002861	S.COI NLV25T-4R7J	T	44.6/54.7
L229	6200004671	S.COI NLV25T-3R9J	T	35.1/51.5
L230	6200002041	S.COI NLV25T-101J	B	40.4/52.2
L231	6200002041	S.COI NLV25T-101J	B	40.4/49.4
L232	6200002041	S.COI NLV25T-101J	B	27.1/49.1
L233	6200002041	S.COI NLV25T-101J	B	26.4/46.2
L234	6200010780	S.COI C2520C-1R0G-A	T	35.5/48.5
L235	6200010530	S.COI C2520C-R56G-A (0.56U)	B	32.9/49.5
L236	6200010950	S.COI C2520C-1R5G-A (1.5U)	T	43.4/50.4
L237	6200010450	S.COI C2520C-R82G-A (0.82U)	B	32.9/46.3
L238	6200002041	S.COI NLV25T-101J	B	43.9/45
L239	6200002041	S.COI NLV25T-101J	B	38.8/39.5
L240	6200002041	S.COI NLV25T-101J	T	29.5/42.1
L241	6200010870	S.COI C2520C-R33G-A (0.33U)	B	35.1/41.6
L242	6200005011	S.COI NLV25T-100J	T	33.5/29.9
L243	6140004601	S.COI LR-518A	T	28.4/35.2
L244	6200010960	S.COI C2520C-R47G-A (0.47U)	B	39.7/44.1
L245	6200005011	S.COI NLV25T-100J	B	41.2/28.3
L246	6200009990	S.COI C2012C-R22G-A	B	30.7/36.4
L247	6200010320	S.COI C2012C-R15G-A	B	42.1/38.7
L248	6200005011	S.COI NLV25T-100J	B	43.8/36.3
L301	6200002041	S.COI NLV25T-101J	T	36.1/27.4
L302	6200002041	S.COI NLV25T-101J	T	52.6/31.8
L303	6200002041	S.COI NLV25T-101J	T	52.3/35.4
L304	6140004591	S.COI LR-517A	T	56.4/39
L305	6200002041	S.COI NLV25T-101J	T	52.8/29.3
L306	6200002041	S.COI NLV25T-101J	T	61.7/39.3
L307	6200002041	S.COI NLV25T-101J	T	60.9/32
L308	6200002041	S.COI NLV25T-101J	T	64.9/33.1
L309	6200009070	S.COI LQW18AN18NG00D (LQW1608A18NG00)	T	49.3/24
L310	6200010650	S.COI C2520C-R12G-A (0.12U)	T	65.7/38.2
L311	6200009220	S.COI LQW18AN15NG00D (LQW1608A15NG00)	T	53.5/23.2
L312	6200010660	S.COI C2520C-R15G-A (0.15U)	T	69.6/34.3
L313	6200011730	S.COI LQW18AN10NG00D	T	61.5/25.7
L314	6200002041	S.COI NLV25T-101J	T	72.5/37.3
L315	6200002041	S.COI NLV25T-101J	T	75.8/31.9
L402	6140004610	S.COI LR-520	T	70.8/27.9
L403	6200002041	S.COI NLV25T-101J	T	81.1/19.7
L404	6130002961	S.COI #617DB-1327=P3	T	84.4/27.9
L406	6130002961	S.COI #617DB-1327=P3	T	77.6/24.2
L421	6200004590	S.COI MLF1608D R18K-T	T	86.4/21.7
L501	6200004660	S.COI MLF1608A 1R8K-T	T	93.4/35.7
L503	6200004660	S.COI MLF1608A 1R8K-T	T	83.2/31.1
L507	6200001981	S.COI NLV25T-1R0J	T	78.7/34.4
L508	6200010650	S.COI C2520C-R12G-A (0.12U)	T	86.3/34.4
L509	6200004660	S.COI MLF1608A 1R8K-T	T	93.1/38.7
L511	6200004150	S.COI MLF1608D 47NM-T	T	92.7/37.2
L512	6200009610	S.COI MLG1608B 39NJ-T	B	89.6/32.8
L601	6200004660	S.COI MLF1608A 1R8K-T	B	85.7/38.6
L603	6200004660	S.COI MLF1608A 1R8K-T	T	89.3/42.2
L604	6150005330	S.COI LS-548 PKI-4185	T	90.5/46.2
L605	6200004660	S.COI MLF1608A 1R8K-T	T	93.1/39.9
L607	6200011800	S.COI C2520C-47NG-A	B	85.6/43.5
L609	6200011800	S.COI C2520C-47NG-A	B	81.5/46
L610	6200004660	S.COI MLF1608A 1R8K-T	B	78.1/44.8
L611	6200004660	S.COI MLF1608A 1R8K-T	T	68/46.3
L612	6150005330	S.COI LS-548 PKI-4185	T	72.2/42.4
L701	6150005350	S.COI LS-550 PKI-4187	T	62.9/48.6
L702	6150005340	S.COI LS-549 PKI-4186	T	54.8/45.4
L703	6150005350	S.COI LS-550 PKI-4187	T	55.3/59.5
L704	6200004940	S.COI MLF1608D R27K-T	T	62.3/59.6
L705	6200009920	S.COI C2012C-R10G-A	T	61.8/41.7
L801	6140002810	S.COI LR-317	T	68.6/61.3
L802	6200005190	S.COI MLF1608D R56K-T	T	89/58.4
L803	6140002810	S.COI LR-317	T	79.6/60.1
L804	6200005011	S.COI NLV25T-100J	T	57.5/69.1
L805	6200009871	S.COI MLF1608D 120J	T	57.6/71.9
L806	6200004741	S.COI NLV25T-1R2J	T	63.1/71.2
L807	6200004741	S.COI NLV25T-1R2J	T	63.2/66.7
L808	6200004100	S.COI MLF1608D 68NM-T	T	86.1/61.6
L901	6200003520	S.COI ELJFB 102K-F	B	37.6/72.4
L904	6150005360	S.COI LS-551 PKI-4188-1	T	51.6/70.9
L905	6200003520	S.COI ELJFB 102K-F	B	40.2/59.9
L906	6200003520	S.COI ELJFB 102K-F	B	33.6/62.4
L908	6200003520	S.COI ELJFB 102K-F	B	31.5/69.7
L1003	6200003520	S.COI ELJFB 102K-F	B	12.9/75.3
L1102	6200002041	S.COI NLV25T-101J	T	7.1/89.7
L1301	6200002041	S.COI NLV25T-101J	T	8.3/55.8
L1302	6200002041	S.COI NLV25T-101J	T	11.8/58.5
L1303	6200002041	S.COI NLV25T-101J	T	4.8/55.8
L1401	6200002041	S.COI NLV25T-101J	B	43.3/79.6
L1402	6200004790	S.COI MLF1608D R47K-T	B	44.1/70.4
L1403	6200002041	S.COI NLV25T-101J	B	43/77.1
L1404	6200003711	S.COI NLV25T-2R7J	B	18.2/80.4
L1405	6200002041	S.COI NLV25T-101J	B	17.7/85
L1491	6200010870	S.COI C2520C-R33G-A (0.33U) [EUR]	B	84.9/30.7
	6200010870	S.COI C2520C-R33G-A (0.33U) [FRA]		
	6200010870	S.COI C2520C-R33G-A (0.33U) [ESP]		
	6200010740	S.COI C2520C-R27G-A [USA]		
	6200010870	S.COI C2520C-R33G-A (0.33U) [EXP]		

[MAIN UNIT]

REF NO.	PARTS NO.	DESCRIPTION	M.	H/V LOCATION
L1491	6200010870	S.COI C2520C-R33G-A (0.33U) [ITR]		
	6200010870	S.COI C2520C-R33G-A (0.33U) [UK]		
	6200010740	S.COI C2520C-R27G-A [KOR]		
	6200010870	S.COI C2520C-R33G-A (0.33U) [AUS]		
	6200010870	S.COI C2520C-R33G-A (0.33U) [CHN]		
L1492	6200010870	S.COI C2520C-R33G-A (0.33U) [EUR]	B	80.6/33.1
	6200010870	S.COI C2520C-R33G-A (0.33U) [FRA]		
	6200010870	S.COI C2520C-R33G-A (0.33U) [ESP]		
	6200010740	S.COI C2520C-R27G-A [USA]		
	6200010870	S.COI C2520C-R33G-A (0.33U) [EXP]		
	6200010870	S.COI C2520C-R33G-A (0.33U) [ITR]		
	6200010870	S.COI C2520C-R33G-A (0.33U) [UK]		
	6200010740	S.COI C2520C-R27G-A [KOR]		
	6200010870	S.COI C2520C-R33G-A (0.33U) [AUS]		
	6200010870	S.COI C2520C-R33G-A (0.33U) [CHN]		
L1501	6200005011	S.COI NLV25T-100J	B	91.1/27.1
L1502	6200012170	S.COI MLG1608SR18J-T	B	79.4/38.2
L1503	6200012170	S.COI MLG1608SR18J-T	B	82/37.5
L1504	6200005011	S.COI NLV25T-100J	B	75.6/43.4
L1505	6200005190	S.COI MLF1608D R56K-T	B	73.2/48.5
L1506	6150005080	S.COI LS-535 (4KMH) [EUR]	T	68.7/55.4
	6150005080	S.COI LS-535 (4KMH) [FRA]		
	6150005080	S.COI LS-535 (4KMH) [ESP]		
	6150005070	S.COI LS-534 (4KMH) [USA]		
	6150005080	S.COI LS-535 (4KMH) [EXP]		
	6150005080	S.COI LS-535 (4KMH) [ITR]		
	6150005080	S.COI LS-535 (4KMH) [UK]		
	6150005070	S.COI LS-534 (4KMH) [KOR]		
	6150005080	S.COI LS-535 (4KMH) [AUS]		
	6150005080	S.COI LS-535 (4KMH) [CHN]		
L1507	6200005031	S.COI NLV25T-180J	B	71.7/62.2
L1508	6200005021	S.COI NLV25T-150J	B	77.3/79.5
L1951	6180003610	S.COI 7E10L-101M 100U 0	B	34.6/10.9
L1952	6180003610	S.COI 7E10L-101M 100U 0	B	54.7/113.3
L1953	6180003610	S.COI 7E10L-101M 100U 0	B	14/111.9
L1954	6180003610	S.COI 7E10L-101M 100U 0	B	24.4/119.8
L2001	6200005011	S.COI NLV25T-100J	B	72.5/16.4
L2002	6200002041	S.COI NLV25T-101J	B	84.5/3.8
L2003	6200002041	S.COI NLV25T-101J	B	81.1/4.3
L2004	6200002041	S.COI NLV25T-101J	B	76.3/20.4
L2006	6200002041	S.COI NLV25T-101J	B	64.2/12.8
L2007	6200002041	S.COI NLV25T-101J	B	70.9/3.8
L2008	6200002041	S.COI NLV25T-101J	B	67.9/6.1
L2009	6200005011	S.COI NLV25T-100J	B	70.8/10.6
L2010	6200002041	S.COI NLV25T-101J	B	60.7/13.7
L2011	6200011300	S.COI EXCML16A270U	T	86.6/9.1
L2012	6200011300	S.COI EXCML16A270U	B	84.7/21.9
L2013	6200002041	S.COI NLV25T-101J	B	71.8/19.4
L2015	6200002041	S.COI NLV25T-101J	B	52.5/10.4
L2016	6200002041	S.COI NLV25T-101J	B	59.2/11.2
L2017	6200002041	S.COI NLV25T-101J	B	57/14
L2018	6200002041	S.COI NLV25T-101J	B	19.7/129.4
L2019	6200002041	S.COI NLV25T-101J	B	22.2/126.9
L2020	6200002041	S.COI NLV25T-101J	B	27.9/131.3
L2021	6200005011	S.COI NLV25T-100J	B	27.9/126.6
L2022	6200002041	S.COI NLV25T-101J	B	22.6/127.6
L2023	6200002041	S.COI NLV25T-101J	B	23.2/131.3
L2024	6200002041	S.COI NLV25T-101J	T	12.7/128.2
L2025	6200002041	S.COI NLV25T-101J	B	87.5/6.2
L2026	6200002041	S.COI NLV25T-101J	B	77.6/5
L2027	6200002041	S.COI NLV25T-101J	B	76.5/12.2
L2028	6200002041	S.COI NLV25T-101J	B	67.4/10.3
L2029	6200002041	S.COI NLV25T-101J	B	64/10.3
L2030	6200002041	S.COI NLV25T-101J	B	67.5/3.6
L2031	6200002041	S.COI NLV25T-101J	B	76.5/14.7
L2032	6200002041	S.COI NLV25T-101J	B	66.1/15.3
L2033	6200011300	S.COI EXCML16A270U	B	69.6/14.3
L2034	6200009300	S.COI ELJPA 100KF 10U	B	67.8/19.5
L2035	6200002041	S.COI NLV25T-101J	B	59.8/18.4
L2036	6200002041	S.COI NLV25T-101J	B	64.1/3.8
L2037	6200002041	S.COI NLV25T-101J	B	88.3/3.7
L2041	6180003610	S.COI 7E10L-101M 100U 0	B	62.6/86.9
L2042	6200002861	S.COI NLV25T-4R7J	B	62.9/79.3
L2053	6200002041	S.COI NLV25T-101J	B	28.7/90.9
L2151	6200002041	S.COI NLV25T-101J	B	36.9/121
L2152	6200002041	S.COI NLV25T-101J	B	52.3/14.7
L2201	6200005011	S.COI NLV25T-100J	T	27.3/125.8
L2202	6200005011	S.COI NLV25T-100J	T	17/124.3
L2231	6200002041	S.COI NLV25T-101J	T	34/104.2
L2256	6200002041	S.COI NLV25T-101J	T	15/103.4
L2257	6200002041	S.COI NLV25T-101J	T	10.5/89.7
L2260	6200002041	S.COI NLV25T-101J	T	68.5/110.9
L2263	6200002041	S.COI NLV25T-101J	T	62.3/99.4
L2264	6200002041	S.COI NLV25T-101J	T	62.3/96.9
L2265	6200002041	S.COI NLV25T-101J	T	62.4/94.3
L2266	6200002041	S.COI NLV25T-101J	T	62.4/91.5
L2267	6200002041	S.COI NLV25T-101J	T	66/89.6
L2268	6200002041	S.COI NLV25T-101J	T	62.4/87.1
L2272	6200002041	S.COI NLV25T-101J	T	71.1/90.2
L2402	6200002041	S.COI NLV25T-101J	B	89.4/98
L2403	6200002041	S.COI NLV25T-101J	B	89.2/84
L2404	6200002041			

[MAIN UNIT]

REF NO.	PARTS NO.	DESCRIPTION	M.	H/V LOCATION
R1	7030011400	S.RES ERJ2GEJ 5R6 X (5.6)	T	79.7/17
R2	7030009270	S.RES ERJ2GEJ 821 X (820)	T	81.3/17
R3	7030009270	S.RES ERJ2GEJ 821 X (820)	T	79.7/17.9
R5	7030010090	S.RES ERJ2GEJ 180 X (18)	T	74.2/16.7
R6	7030008280	S.RES ERJ2GEJ 271 X (270)	T	74.8/15.8
R7	7030008280	S.RES ERJ2GEJ 271 X (270)	T	73.2/15.8
R8	7030009200	S.RES ERJ2GEJ 390 X (39)	T	73/18.5
R9	7030003400	S.RES ERJ3GEJ 471 V (470)	T	69.9/13.3
R10	7030005120	S.RES ERJ2GEJ 102 X (1K)	T	72.8/14.9
R11	7030005300	S.RES ERJ2GEJ 150 X (15)	T	62.1/15.9
R12	7030010040	S.RES ERJ2GEJ-JPW	T	62.9/13.8
R13	7030005090	S.RES ERJ2GEJ 104 X (100K)	T	66.8/20.6
R15	7030005090	S.RES ERJ2GEJ 104 X (100K)	T	70.4/10.4
R16	7030003860	S.RES ERJ3GE JPW V	T	62.4/12.3
R17	7030005090	S.RES ERJ2GEJ 104 X (100K)	T	76.4/15.8
R18	7030007270	S.RES ERJ2GEJ 151 X (150)	T	44.2/17.2
R19	7030003860	S.RES ERJ3GE JPW V	T	50.4/14.6
R20	7030009530	S.RES ERJ2GEJ 270 X (27)	T	69.5/19.7
R21	7030009530	S.RES ERJ2GEJ 270 X (27)	T	65.4/22.8
R22	7030010040	S.RES ERJ2GEJ-JPW	T	78.1/13.8
R23	7030007290	S.RES ERJ2GEJ 222 X (2.2K)	T	79.8/13.8
R24	7030005010	S.RES ERJ2GEJ 681 X (680)	T	78.1/12.9
R25	7030005120	S.RES ERJ2GEJ 102 X (1K)	B	79.2/18.5
R27	7030005120	S.RES ERJ2GEJ 102 X (1K)	B	81.3/8.5
R29	7030004980	S.RES ERJ2GEJ 101 X (100)	T	73.1/11.3
R30	7030009160	S.RES ERJ2GEJ 181 X (180)	T	46.4/15.4
R31	7030007270	S.RES ERJ2GEJ 151 X (150)	T	42.6/17.1
R32	7030009200	S.RES ERJ2GEJ 390 X (39)	T	44.1/18.2
R35	7030003860	S.RES ERJ3GE JPW V	T	59.9/17.8
	7030003860	S.RES ERJ3GE JPW V	[EUR]	
	7030003860	S.RES ERJ3GE JPW V	[FRA]	
	7030003860	S.RES ERJ3GE JPW V	[ESP]	
	7030003860	S.RES ERJ3GE JPW V	[USA]	
	7030003860	S.RES ERJ3GE JPW V	[EXP]	
	7030003860	S.RES ERJ3GE JPW V	[ITR]	
	7030003860	S.RES ERJ3GE JPW V	[UK]	
	7030003860	S.RES ERJ3GE JPW V	[KOR]	
	7030003860	S.RES ERJ3GE JPW V	[CHN]	
R101	7030005050	S.RES ERJ2GEJ 103 X (10K)	T	13.2/16
R102	7030005120	S.RES ERJ2GEJ 102 X (1K)	T	11.9/14.6
R103	7030005050	S.RES ERJ2GEJ 103 X (10K)	T	10.3/14.6
R104	7030005090	S.RES ERJ2GEJ 104 X (100K)	T	15.7/13.4
R105	7030005580	S.RES ERJ2GEJ 560 X (56)	T	15.7/22.2
R106	7030005000	S.RES ERJ2GEJ 471 X (470)	T	13.2/20.5
R107	7030005000	S.RES ERJ2GEJ 471 X (470)	T	10.8/22.1
R108	7030005000	S.RES ERJ2GEJ 471 X (470)	T	10.8/21.2
R111	7030005000	S.RES ERJ2GEJ 471 X (470)	T	10.8/21.2
R112	7030005090	S.RES ERJ2GEJ 104 X (100K)	T	25.6/12.5
R113	7030005090	S.RES ERJ2GEJ 104 X (100K)	T	26.8/10.4
R114	7030009280	S.RES ERJ2GEJ 391 X	B	33.1/23.4
R115	7030009280	S.RES ERJ2GEJ 391 X	B	34.1/22.2
R116	7030009280	S.RES ERJ2GEJ 391 X	T	22.3/21.3
R117	7030009280	S.RES ERJ2GEJ 391 X	T	20.7/21.3
R118	7030009280	S.RES ERJ2GEJ 391 X	B	40.9/23.2
R119	7030009280	S.RES ERJ2GEJ 391 X	B	40.9/23.2
R120	7030005090	S.RES ERJ2GEJ 104 X (100K)	B	50.3/23.5
R121	7030005090	S.RES ERJ2GEJ 104 X (100K)	T	44/22.2
R122	7030009280	S.RES ERJ2GEJ 391 X	T	7.8/20.3
R123	7030009280	S.RES ERJ2GEJ 391 X	T	7.8/19.4
R125	7030009280	S.RES ERJ2GEJ 391 X	T	35.5/20.2
R126	7030009280	S.RES ERJ2GEJ 391 X	T	27.4/8
R127	7030009280	S.RES ERJ2GEJ 391 X	T	25.4/4.8
R128	7030009280	S.RES ERJ2GEJ 391 X	T	35.5/19.3
R202	7030005090	S.RES ERJ2GEJ 104 X (100K)	T	18.1/31.2
R203	7030005090	S.RES ERJ2GEJ 104 X (100K)	T	42.9/59.9
R204	7030005090	S.RES ERJ2GEJ 104 X (100K)	B	42.9/54.3
R205	7030009280	S.RES ERJ2GEJ 391 X	T	19.4/54.2
R206	7030005090	S.RES ERJ2GEJ 104 X (100K)	B	42.9/51.4
R207	7030005090	S.RES ERJ2GEJ 104 X (100K)	B	42.9/50.5
R208	7030005090	S.RES ERJ2GEJ 104 X (100K)	B	46.4/45
R216	7030005090	S.RES ERJ2GEJ 104 X (100K)	B	44.2/43.3
R217	7030005050	S.RES ERJ2GEJ 103 X (10K)	T	18.1/30.3
R218	7030004970	S.RES ERJ2GEJ 470 X (47)	T	21.9/29.9
R225	7030005050	S.RES ERJ2GEJ 103 X (10K)	T	19.1/29.1
R226	7030009280	S.RES ERJ2GEJ 391 X	T	17.6/54.2
R227	7030005120	S.RES ERJ2GEJ 102 X (1K)	T	30.9/30.9
R228	7030009140	S.RES ERJ2GEJ 272 X (2.7K)	T	30.9/29.1
R301	7030009280	S.RES ERJ2GEJ 391 X	T	44.5/28.8
R302	7030009280	S.RES ERJ2GEJ 391 X	T	38.6/27.8
R303	7030004970	S.RES ERJ2GEJ 470 X (47)	T	52.5/38.9
R304	7030004980	S.RES ERJ2GEJ 101 X (100)	T	55.1/35.6
R305	7030005120	S.RES ERJ2GEJ 102 X (1K)	T	59.9/33.8
R306	7030008280	S.RES ERJ2GEJ 271 X (270)	T	55.3/28.7
R307	7030004980	S.RES ERJ2GEJ 101 X (100)	T	56.7/35.6
R308	7030007290	S.RES ERJ2GEJ 222 X (2.2K)	T	59.2/30.1
R309	7030008280	S.RES ERJ2GEJ 271 X (270)	T	58.5/29.1
R310	7030005090	S.RES ERJ2GEJ 104 X (100K)	T	50.1/31.7
R311	7030009280	S.RES ERJ2GEJ 391 X	T	65.3/31.3
R312	7030009280	S.RES ERJ2GEJ 391 X	T	63.7/31.3
R314	7030009280	S.RES ERJ2GEJ 391 X	T	73.3/32.5
R315	7030009280	S.RES ERJ2GEJ 391 X	T	74.8/33.8
R401	7030010040	S.RES ERJ2GEJ-JPW	T	75/29.5
R402	7030010040	S.RES ERJ2GEJ-JPW	T	75/27.7
R403	7030004980	S.RES ERJ2GEJ 101 X (100)	T	76.7/29.6
R404	7030010040	S.RES ERJ2GEJ-JPW	T	71.9/23.1
R405	7030004980	S.RES ERJ2GEJ 101 X (100)	T	86.8/23.8
R406	7030005580	S.RES ERJ2GEJ 560 X (56)	T	71.1/30.6
R407	7030005580	S.RES ERJ2GEJ 560 X (56)	T	71.9/24.9
R408	7030010040	S.RES ERJ2GEJ-JPW	T	83.3/19.2
R411	7030007260	S.RES ERJ2GEJ 330 X (33)	T	80/29.5

[MAIN UNIT]

REF NO.	PARTS NO.	DESCRIPTION	M.	H/V LOCATION
R412	7030007260	S.RES ERJ2GEJ 330 X (33)	T	80/26.8
R414	7030004980	S.RES ERJ2GEJ 101 X (100)	T	78.3/29.6
R416	7030010090	S.RES ERJ2GEJ 180 X (18)	T	88.3/24.4
R417	7030008280	S.RES ERJ2GEJ 271 X (270)	T	89.2/25.3
R418	7030008280	S.RES ERJ2GEJ 271 X (270)	T	88/22.8
R421	7030010090	S.RES ERJ2GEJ 180 X (18)	B	88.5/20.9
R422	7030008280	S.RES ERJ2GEJ 271 X (270)	B	90.1/20.2
R423	7030008280	S.RES ERJ2GEJ 271 X (270)	B	90.1/19.3
R424	7030005530	S.RES ERJ2GEJ 100 X (10)	T	88.5/21.6
R501	7030005120	S.RES ERJ2GEJ 102 X (1K)	T	91.3/35.6
R502	7030005120	S.RES ERJ2GEJ 102 X (1K)	T	92.9/34.4
R509	7030005580	S.RES ERJ2GEJ 560 X (56)	T	83.4/33.1
R510	7030010040	S.RES ERJ2GEJ-JPW	T	83.4/34.1
R512	7030004980	S.RES ERJ2GEJ 101 X (100)	T	81.7/34.1
R517	7030010040	S.RES ERJ2GEJ-JPW	B	80/31
R518	7030007290	S.RES ERJ2GEJ 222 X (2.2K)	T	79.5/37
R519	7030007290	S.RES ERJ2GEJ 222 X (2.2K)	T	79.5/38.8
R520	7030005120	S.RES ERJ2GEJ 102 X (1K)	T	89.1/39.2
R521	7030005000	S.RES ERJ2GEJ 471 X (470)	T	84.2/40.4
R523	7030005120	S.RES ERJ2GEJ 102 X (1K)	T	91.3/34.7
R524	7030005120	S.RES ERJ2GEJ 102 X (1K)	B	86.9/37
R601	7030005000	S.RES ERJ2GEJ 471 X (470)	B	88.5/40
R602	7030005000	S.RES ERJ2GEJ 471 X (470)	T	91/39.6
R603	7030005000	S.RES ERJ2GEJ 471 X (470)	T	89.1/41
R604	7030005000	S.RES ERJ2GEJ 471 X (470)	B	78.6/45.9
R605	7030010040	S.RES ERJ2GEJ-JPW	T	68.2/45.2
R606	7030005090	S.RES ERJ2GEJ 104 X (100K)	T	67.1/47.4
R607	7030005120	S.RES ERJ2GEJ 102 X (1K)	T	66.6/45.2
R701	7030005220	S.RES ERJ2GEJ 223 X (22K)	T	61.1/52.3
R702	7030005120	S.RES ERJ2GEJ 102 X (1K)	T	64.2/43.9
R703	7030004970	S.RES ERJ2GEJ 470 X (47)	T	50.8/44.1
R705	7030004990	S.RES ERJ2GEJ 221 X (220)	T	59/51.5
R706	7030009270	S.RES ERJ2GEJ 821 X (820)	T	64.5/55.9
R707	7030004980	S.RES ERJ2GEJ 101 X (100)	T	59.5/57
R708	7030007290	S.RES ERJ2GEJ 222 X (2.2K)	T	63.9/58.6
R709	7030005210	S.RES ERJ2GEJ 822 X (8.2K)	T	59.5/55.1
R710	7030005120	S.RES ERJ2GEJ 102 X (1K)	T	59.8/62.5
R711	7030009140	S.RES ERJ2GEJ 272 X (2.7K)	T	50.5/51.4
R712	7030005120	S.RES ERJ2GEJ 102 X (1K)	T	51.2/50.5
R713	7030005050	S.RES ERJ2GEJ 103 X (10K)	T	57.1/51.5
R715	7030004970	S.RES ERJ2GEJ 470 X (47)	T	52.1/54.1
R716	7030005710	S.RES ERJ2GEJ 121 X (120)	T	51.3/57.5
R717	7030007300	S.RES ERJ2GEJ 332 X (3.3K)	T	52.1/51.4
R718	7510001461	S.THE NTCG16 3NH 471JT	T	63.3/54
R801	7030008280	S.RES ERJ2GEJ 271 X (270)	T	86.8/55.2
R802	7030005120	S.RES ERJ2GEJ 102 X (1K)	T	65.3/60.9
R803	7030005120	S.RES ERJ2GEJ 102 X (1K)	T	71.9/64.9
R804	7030005530	S.RES ERJ2GEJ 100 X (10)	T	91.1/57.1
R805	7030010090	S.RES ERJ2GEJ 180 X (18)	T	84.7/54.3
R806	7030008280	S.RES ERJ2GEJ 271 X (270)	T	85.2/55.2
R807	7030005120	S.RES ERJ2GEJ 102 X (1K)	T	62.8/64.6
R808	7030004970	S.RES ERJ2GEJ 470 X (47)	T	62.3/69.4
R809	7030008280	S.RES ERJ2GEJ 271 X (270)	T	82.8/60.6
R810	7030010090	S.RES ERJ2GEJ 180 X (18)	T	84.4/60.6
R811	7030008280	S.RES ERJ2GEJ 271 X (270)	T	82.8/59.7
R904	7030003860	S.RES ERJ3GE JPW V	T	36.5/68.1
R905	7030004980	S.RES ERJ2GEJ 101 X (100)	T	39.2/64.6
R906	7030007290	S.RES ERJ2GEJ 222 X (2.2K)	T	39.2/66.5
R908	7030005000	S.RES ERJ2GEJ 471 X (470)	T	35.6/61.9
R909	7030008410	S.RES ERJ2GEJ 392 X (3.9K)	T	34.2/68.4
R912	7030005210	S.RES ERJ2GEJ 822 X (8.2K)	T	34.2/66.6
R913	7030007300	S.RES ERJ2GEJ 332 X (3.3K)	T	40.5/75
R914	7030009290	S.RES ERJ2GEJ 562 X (5.6K)	T	35.6/75.4
R915	7030007290	S.RES ERJ2GEJ 222 X (2.2K)	T	36.6/70.9
R916	7030005050	S.RES ERJ2GEJ 103 X (10K)	T	37.2/75.4
R917	7030004970	S.RES ERJ2GEJ 470 X (47)	T	34.2/69.3
R918	7030007290	S.RES ERJ2GEJ 222 X (2.2K)	B	31.4/72.1
R919	7030004980	S.RES ERJ2GEJ 101 X (100)	T	31.5/72.1
R1009	7030009290	S.RES ERJ2GEJ 562 X (5.6K)	T	25.8/72.9
R1018	7030007290	S.RES ERJ2GEJ 222 X (2.2K)	T	20.3/75
R1019	7030005050	S.RES ERJ2GEJ 103 X (10K)	T	20.3/76.9
R1020	7030005000	S.RES ERJ2GEJ 471 X (470)	T	12.7/77.6
R1022	7510001461	S.THE NTCG16 3NH 471JT	T	14.8/76.8
R1023	7030008370	S.RES ERJ2GEJ 561 X (560)	T	15.2/77.8
R1024	7030004980	S.RES ERJ2GEJ 101 X (100)	T	12.7/74.9
R1025	7030007260	S.RES ERJ2GEJ 330 X (33)	T	12.7/76.7
R1027	7030005120	S.RES ERJ2GEJ 102 X (1K)	T	4.6/87.8
R1201	7030005000	S.RES ERJ2GEJ 471 X (470)	T	25.7/77.6
R1202	7030005240	S.RES ERJ2GEJ 473 X (47K)	T	24.7/8.5
R1203	7030005240	S.RES ERJ2GEJ 473 X (47K)	T	25.6/78.5
R1204	7030005240	S.RES ERJ2GEJ 473 X (47K)	T	20.2/79.2
R1205	7030005000	S.RES ERJ2GEJ 471 X (470)	T	20.2/78.3
R1206	7030005090	S.RES ERJ2GEJ 104 X (100K)	T	21.8/79.2
R1207	7030005240	S.RES ERJ2GEJ 473 X (47K)	T	17.9/83.6
R1208	7030004980	S.RES ERJ2GEJ 101 X (100)	T	9.4/79.8
R1209	7030004980	S.RES ERJ2GEJ 101 X (100)	T	16.4/79.9
R1211	7030005120	S.RES ERJ2GEJ 102 X (1K)</		

[MAIN UNIT]

REF NO.	PARTS NO.	DESCRIPTION	M.	H/V LOCATION
R1306	7030005120	S.RES ERJ2GEJ 102 X (1K)	T	10.9/56.8
R1308	7030007300	S.RES ERJ2GEJ 332 X (3.3K)	T	12.9/67.3
R1309	7030005120	S.RES ERJ2GEJ 102 X (1K)	T	11.3/66.4
R1310	7510001451	S.THE NTCG16 4BH 472JT	T	12.2/68.4
R1401	7030005120	S.RES ERJ2GEJ 102 X (1K)	B	45.3/72.3
R1402	7030008010	S.RES ERJ2GEJ 123 X (12K)	B	43.6/72.3
R1403	7030007290	S.RES ERJ2GEJ 222 X (2.2K)	B	44.5/73.4
R1404	7030007280	S.RES ERJ2GEJ 331 X (330)	B	44.5/75.2
R1405	7030004970	S.RES ERJ2GEJ 470 X (47)	B	42/71.5
R1406	7030005290	S.RES ERJ2GEJ 682 X (6.8K)	B	38.7/79.9
R1407	7030005120	S.RES ERJ2GEJ 102 X (1K)	B	38.7/77.9
R1408	7030007280	S.RES ERJ2GEJ 331 X (330)	B	38.7/80.8
R1409	7030004970	S.RES ERJ2GEJ 470 X (47)	B	34.6/80
R1414	7030007340	S.RES ERJ2GEJ 153 X (15K)	B	20.2/76.4
R1416	7030008410	S.RES ERJ2GEJ 392 X (3.9K)	B	19.4/83
R1420	7030004990	S.RES ERJ2GEJ 221 X (220)	B	25/76.8
R1421	7030007270	S.RES ERJ2GEJ 151 X (150)	B	23.2/75.9
R1422	7030004990	S.RES ERJ2GEJ 221 X (220)	B	23.2/76.8
R1501	7030010040	S.RES ERJ2GEJ-JPW	B	72.4/38.2
R1502	7030005100	S.RES ERJ2GEJ 154 X (150K)	B	86.4/55.3
R1503	7030005100	S.RES ERJ2GEJ 154 X (150K)	B	85.7/54.1
R1504	7030004970	S.RES ERJ2GEJ 470 X (47)	B	72.4/40.3
R1505	7030007290	S.RES ERJ2GEJ 222 X (2.2K)	B	71.8/53.9
R1506	7030007350	S.RES ERJ2GEJ 393 X (39K)	B	85.7/52.3
R1507	7030007350	S.RES ERJ2GEJ 393 X (39K)	B	85.7/53.2
R1508	7030005220	S.RES ERJ2GEJ 223 X (22K)	B	74.2/61.6
R1509	7030006610	S.RES ERJ2GEJ 394 X (390K)	B	85.9/59
R1510	7030005050	S.RES ERJ2GEJ 103 X (10K)	[USA]	76.6/61.9
R1511	7030005590	S.RES ERJ2GEJ 680 X (68)	B	85.8/60.8
R1512	7030005120	S.RES ERJ2GEJ 102 X (1K)	B	71.5/73.7
R1513	7030007280	S.RES ERJ2GEJ 331 X (330)	B	73.1/73.7
R1514	7030007290	S.RES ERJ2GEJ 222 X (2.2K)	B	73.4/53
R1515	7030007290	S.RES ERJ2GEJ 222 X (2.2K)	B	71.8/53
R1516	7030004970	S.RES ERJ2GEJ 470 X (47)	B	82.5/35.3
R1521	7030005090	S.RES ERJ2GEJ 104 X (100K)	B	86.5/50.3
R1522	7030005240	S.RES ERJ2GEJ 473 X (47K)	B	86.7/46.8
R1523	7030005120	S.RES ERJ2GEJ 102 X (1K)	B	77.3/39.5
R1524	7030005120	S.RES ERJ2GEJ 102 X (1K)	B	81.9/40.3
R1525	7030007300	S.RES ERJ2GEJ 332 X (3.3K)	B	81.9/42.2
R1526	7030005120	S.RES ERJ2GEJ 102 X (1K)	B	83.5/40.5
R1602	7030005120	S.RES ERJ2GEJ 102 X (1K)	T	6.3/54
R1603	7030010040	S.RES ERJ2GEJ-JPW	T	13/49.6
R1604	7030007290	S.RES ERJ2GEJ 222 X (2.2K)	T	13/50.5
R1605	7030005090	S.RES ERJ2GEJ 104 X (100K)	T	8.8/46.9
R1606	7030005070	S.RES ERJ2GEJ 683 X (68K)	T	6.1/46.6
R1607	7030005070	S.RES ERJ2GEJ 683 X (68K)	T	5.1/42.1
R1608	7030005090	S.RES ERJ2GEJ 104 X (100K)	T	10.4/47.8
R1609	7030007320	S.RES ERJ2GEJ 225 X (2.2M)	T	10.4/46
R1610	7030005060	S.RES ERJ2GEJ 333 X (33K)	T	4.5/43.5
R1611	7030005230	S.RES ERJ2GEJ 334 X (330K)	T	8.8/47.8
R1612	7030005060	S.RES ERJ2GEJ 333 X (33K)	T	3.4/42.3
R1613	7030003860	S.RES ERJ3GE JPW V	T	6.7/48.7
R1614	7030007310	S.RES ERJ2GEJ 155 X (1.5M)	T	6.1/45.7
R1615	7030005040	S.RES ERJ2GEJ 472 X (4.7K)	T	4.2/35.4
R1616	7030005090	S.RES ERJ2GEJ 104 X (100K)	T	6.7/35.4
R1617	7030005720	S.RES ERJ2GEJ 563 X (56K)	T	3.4/38.2
R1618	7310005020	S.TRI RH03ADC14X (10K) 1	T	3.5/46.3
R1619	7030005080	S.RES ERJ2GEJ 823 X (82K)	[EUR]	2.6/43.3
	7030005080	S.RES ERJ2GEJ 823 X (82K)	[FRA]	
	7030005080	S.RES ERJ2GEJ 823 X (82K)	[ESP]	
	7030005080	S.RES ERJ2GEJ 823 X (82K)	[USA]	
	7030005080	S.RES ERJ2GEJ 823 X (82K)	[EXP]	
	7030005080	S.RES ERJ2GEJ 823 X (82K)	[ITR]	
	7030005080	S.RES ERJ2GEJ 823 X (82K)	[UK]	
	7030005080	S.RES ERJ2GEJ 823 X (82K)	[KOR]	
	7030005720	S.RES ERJ2GEJ 563 X (56K)	[AUS]	
	7030005080	S.RES ERJ2GEJ 823 X (82K)	[CHN]	
R1620	7030008290	S.RES ERJ2GEJ 183 X (18K)	T	3.4/37.3
R1621	7030005160	S.RES ERJ2GEJ 105 X (1M)	T	6.7/37.2
R1622	7030010040	S.RES ERJ2GEJ-JPW	T	5/37.3
R1623	7030005000	S.RES ERJ2GEJ 471 X (470)	T	12/46.8
R1624	7030007250	S.RES ERJ2GEJ 220 X (22)	T	14.9/38.3
R1625	7030004990	S.RES ERJ2GEJ 221 X (220)	T	13.6/32.6
R1626	7030005050	S.RES ERJ2GEJ 103 X (10K)	T	10.3/34.5
R1627	7030007320	S.RES ERJ2GEJ 225 X (2.2M)	T	10.3/35.4
R1628	7030005120	S.RES ERJ2GEJ 102 X (1K)	T	4.9/30.8
R1629	7030005050	S.RES ERJ2GEJ 103 X (10K)	T	4.9/29.9
R1630	7030004980	S.RES ERJ2GEJ 101 X (100)	T	8.3/45.7
R1631	7030005090	S.RES ERJ2GEJ 104 X (100K)	T	9.8/37.2
R1634	7030005040	S.RES ERJ2GEJ 472 X (4.7K)	T	10.3/33.6
R1636	7030007320	S.RES ERJ2GEJ 225 X (2.2M)	T	13/31.7
R1637	7030007320	S.RES ERJ2GEJ 225 X (2.2M)	T	12/45.9
R1638	7030008280	S.RES ERJ2GEJ 271 X (270)	T	10.9/48.8
R1639	7030005120	S.RES ERJ2GEJ 102 X (1K)	T	14.6/50.5
R1640	7030005090	S.RES ERJ2GEJ 104 X (100K)	T	10.9/31.6
R1641	7030007320	S.RES ERJ2GEJ 225 X (2.2M)	T	13/30.7
R1642	7030005120	S.RES ERJ2GEJ 102 X (1K)	T	22.9/55.1
R1701	7030009320	S.RES ERJ2GEJ 4R7 X (4.7)	T	48/45.3
R1702	7030007280	S.RES ERJ2GEJ 331 X (330)	B	52.1/44.7
R1703	7030007280	S.RES ERJ2GEJ 331 X (330)	B	53.7/43.8
R1704	7030007280	S.RES ERJ2GEJ 331 X (330)	B	53.7/44.7
R1705	7030009320	S.RES ERJ2GEJ 4R7 X (4.7)	T	48/46.2
R1706	7030007280	S.RES ERJ2GEJ 331 X (330)	B	53.6/64.2
R1707	7030007280	S.RES ERJ2GEJ 331 X (330)	B	55.6/64.8
R1708	7030007280	S.RES ERJ2GEJ 331 X (330)	B	55.6/65.7
R1901	7030005090	S.RES ERJ2GEJ 104 X (100K)	B	20/13.9
R1902	7030011290	S.RES ERJ12YJR8U (1.8)	B	12.4/45.8
R1952	7030009980	S.RES ERJ12RSJR15U	B	42.6/102.3
R1953	7030009980	S.RES ERJ12RSJR15U	B	42.6/98.6

[MAIN UNIT]

REF NO.	PARTS NO.	DESCRIPTION	M.	H/V LOCATION
R1954	7030005170	S.RES ERJ2GEJ 474 X (470K)	B	42.7/111.3
R1955	7030005511	S.RES ERA3YED 303V (30K)	B	44.8/107.3
R1956	7030005110	S.RES ERJ2GEJ 224 X (220K)	B	33.7/105.1
R1957	7030007350	S.RES ERJ2GEJ 393 X (39K)	B	35.3/104.2
R1958	7030005720	S.RES ERJ2GEJ 563 X (56K)	B	35.3/103.3
R1981	7030008240	S.RES ERJ12Y0R00U	B	83.1/109
R2002	7030010040	S.RES ERJ2GEJ-JPW	B	36.9/12.7
R2003	7030008240	S.RES ERJ12Y0R00U	T	55.7/7.9
R2004	7030004990	S.RES ERJ2GEJ 221 X (220)	B	59.8/9.2
R2005	7030004990	S.RES ERJ2GEJ 221 X (220)	B	59.1/3
R2006	7030004990	S.RES ERJ2GEJ 221 X (220)	B	60.7/3.7
R2007	7030004990	S.RES ERJ2GEJ 221 X (220)	B	60.7/4.6
R2008	7030010040	S.RES ERJ2GEJ-JPW	B	34/17.6
R2010	7030010040	S.RES ERJ2GEJ-JPW	B	32.5/15.1
R2011	7030006210	S.RES ERJ12YJ4R7U (4.7)	B	13.1/26.3
R2012	7030005120	S.RES ERJ2GEJ 102 X (1K)	B	32.4/17.3
R2101	7030005090	S.RES ERJ2GEJ 104 X (100K)	T	26/113.8
R2102	7030005090	S.RES ERJ2GEJ 104 X (100K)	T	33.1/114.3
R2103	7030005090	S.RES ERJ2GEJ 104 X (100K)	T	30.7/123.2
R2104	7030005090	S.RES ERJ2GEJ 104 X (100K)	T	28.1/123.2
R2105	7030005090	S.RES ERJ2GEJ 104 X (100K)	T	32.3/118.7
R2106	7030005720	S.RES ERJ2GEJ 563 X (56K)	T	25/115.5
R2107	7030005720	S.RES ERJ2GEJ 563 X (56K)	T	31.5/114.6
R2108	7030005100	S.RES ERJ2GEJ 154 X (150K)	T	30.7/122.3
R2109	7030007350	S.RES ERJ2GEJ 393 X (39K)	T	27.1/122.3
R2110	7030005090	S.RES ERJ2GEJ 104 X (100K)	T	44.3/111.8
R2111	7030005090	S.RES ERJ2GEJ 104 X (100K)	T	44.7/110
R2112	7030005090	S.RES ERJ2GEJ 104 X (100K)	T	54.1/110.8
R2113	7030005090	S.RES ERJ2GEJ 104 X (100K)	T	54.1/111.7
R2114	7030005100	S.RES ERJ2GEJ 154 X (150K)	T	44.7/112.7
R2115	7030005100	S.RES ERJ2GEJ 154 X (150K)	T	44.7/109.1
R2116	7030005100	S.RES ERJ2GEJ 154 X (150K)	T	54.4/109.9
R2117	7030005100	S.RES ERJ2GEJ 154 X (150K)	T	54.1/112.6
R2118	7030005090	S.RES ERJ2GEJ 104 X (100K)	T	54.1/120.6
R2119	7030005090	S.RES ERJ2GEJ 104 X (100K)	T	54.1/121.8
R2120	7030008300	S.RES ERJ2GEJ 184 X (180K)	T	44.8/122.1
R2121	7030008300	S.RES ERJ2GEJ 184 X (180K)	T	42.9/121.3
R2122	7030005100	S.RES ERJ2GEJ 154 X (150K)	T	54.1/119.7
R2123	7030006610	S.RES ERJ2GEJ 394 X (390K)	T	54.2/122.8
R2124	7030005110	S.RES ERJ2GEJ 224 X (220K)	T	44.8/123
R2125	7030005110	S.RES ERJ2GEJ 224 X (220K)	T	44.8/119.4
R2126	7030010040	S.RES ERJ2GEJ-JPW	T	33.1/16.4
R2128	7030005000	S.RES ERJ2GEJ 471 X (470)	T	32.3/123.2
R2129	7030005000	S.RES ERJ2GEJ 471 X (470)	T	54.1/118.8
R2131	7030005090	S.RES ERJ2GEJ 104 X (100K)	B	39.8/122
R2132	7030005090	S.RES ERJ2GEJ 104 X (100K)	T	42.8/115.1
R2133	7030005090	S.RES ERJ2GEJ 104 X (100K)	T	40.6/114.1
R2134	7030005090	S.RES ERJ2GEJ 104 X (100K)	T	36.5/114.1
R2135	7030005090	S.RES ERJ2GEJ 104 X (100K)	T	34.9/114.2
R2136	7030005000	S.RES ERJ2GEJ 471 X (470)	T	26.5/123.2
R2137	7030005230	S.RES ERJ2GEJ 334 X (330K)	T	43.3/123.7
R2138	7030005230	S.RES ERJ2GEJ 334 X (330K)	T	42.9/122.2
R2139	7030004980	S.RES ERJ2GEJ 101 X (100)	T	25/116.4
R2140	7030004980	S.RES ERJ2GEJ 101 X (100)	T	32/115.5
R2141	7030010040	S.RES ERJ2GEJ-JPW	T	44.7/113.6
R2142	7030010040	S.RES ERJ2GEJ-JPW	T	52.7/108.9
R2143	7030010040	S.RES ERJ2GEJ-JPW	T	56/109.9
R2144	7030010040	S.RES ERJ2GEJ-JPW	T	51.3/115.1
R2145	7030010040	S.RES ERJ2GEJ-JPW	T	58.1/123.6
R2146	7030010040	S.RES ERJ2GEJ-JPW	T	46.3/124
R2147	7030010040	S.RES ERJ2GEJ-JPW	T	46/118.5
R2151	7030005240	S.RES ERJ2GEJ 473 X (47K)	T	52.3/101.7
R2152	7030005120	S.RES ERJ2GEJ 102 X (1K)	T	56.5/107.1
R2153	7030005240	S.RES ERJ2GEJ 473 X (47K)	T	24.8/112.5
R2154	7030005120	S.RES ERJ2GEJ 102 X (1K)	T	25.6/111.6
R2155	7030005240	S.RES ERJ2GEJ 473 X (47K)	T	46.1/104.6
R2156	7030005120	S.RES ERJ2GEJ 102 X (1K)	T	46.1/105.5
R2157	7030005530	S.RES ERJ2GEJ 100 X (10)	B	33.3/120.8
R2158	7030005530	S.RES ERJ2GEJ 100 X (10)	B	33.3/119.8
R2159	7030005530	S.RES ERJ2GEJ 100 X (10)	B	35.1/118.3
R2160	7030005530	S.RES ERJ2GEJ 100 X (10)	B	40.7/94.3
R2161	7030005530	S.RES ERJ2GEJ 100 X (10)	B	40.7/95.2
R2162	7030005530	S.RES ERJ2GEJ 100 X (10)	B	30.2/93.8
R2163	7030005530	S.RES ERJ2GEJ 100 X (10)	B	30.9/95.9
R2164	7030005530	S.RES ERJ2GEJ 100 X (10)	B	30.2/94.7
R2165	7030005530	S.RES ERJ2GEJ 100 X (10)	B	29.3/95.9
R2166	7030005530	S.RES ERJ2GEJ 100 X (10)	T	51.8/93.3
R2167	7030005530	S.RES ERJ2GEJ 100 X (10)	T	51.8/94.2
R2168	7030005530	S.RES ERJ2GEJ 100 X (10)	T	51.8/95.1
R2169	7030005120	S.RES ERJ2GEJ 102 X (1K)	T	8.8/118.5
R2170	7030005170	S.RES ERJ2GEJ 474 X (470K)	T	5/104.5
R2171	7030005240	S.RES ERJ2GEJ 473 X (47K)	T	9.7/114.2
R2172	703000			

[MAIN UNIT]

REF NO.	PARTS NO.	DESCRIPTION	M.	H/V LOCATION
R2215	7030005040	S.RES ERJ2GEJ 472 X (4.7K)	T	11.1/120.6
R2217	7030007280	S.RES ERJ2GEJ 331 X (330)	T	24.9/121.5
R2218	7030007270	S.RES ERJ2GEJ 151 X (150)	T	15.5/127.5
R2219	7030007280	S.RES ERJ2GEJ 331 X (330)	T	17.7/126.1
R2220	7030008280	S.RES ERJ2GEJ 271 X (270)	T	16.1/126.1
R2221	7030005050	S.RES ERJ2GEJ 103 X (10K)	T	9.5/120.5
R2230	7030010900	S.RES ERJ3GEVJ 750 V (75)	T	40.4/105.8
R2231	7030005050	S.RES ERJ2GEJ 103 X (10K)	T	4.5/118.2
R2232	7030005050	S.RES ERJ2GEJ 103 X (10K)	T	54.7/117.5
R2251	7030004990	S.RES ERJ2GEJ 221 X (220)	T	6.1/96.9
R2254	7030004990	S.RES ERJ2GEJ 221 X (220)	B	6.8/100.7
R2255	7030004990	S.RES ERJ2GEJ 221 X (220)	B	6.8/101.6
R2256	7030004990	S.RES ERJ2GEJ 221 X (220)	B	6.8/102.5
R2257	7030004990	S.RES ERJ2GEJ 221 X (220)	B	75.3/109
R2258	7030004990	S.RES ERJ2GEJ 221 X (220)	B	70.9/106.5
R2259	7030004990	S.RES ERJ2GEJ 221 X (220)	B	75.3/107.8
R2260	7030004990	S.RES ERJ2GEJ 221 X (220)	B	71/105.6
R2261	7030004990	S.RES ERJ2GEJ 221 X (220)	B	75.3/106.6
R2262	7030004990	S.RES ERJ2GEJ 221 X (220)	B	71.4/104.5
R2263	7030004990	S.RES ERJ2GEJ 221 X (220)	B	75.6/104.5
R2264	7030004990	S.RES ERJ2GEJ 221 X (220)	B	72.2/103.6
R2267	7030004990	S.RES ERJ2GEJ 221 X (220)	T	78.6/104.1
R2268	7030004990	S.RES ERJ2GEJ 221 X (220)	T	78.6/103.2
R2269	7030004990	S.RES ERJ2GEJ 221 X (220)	T	78.6/102.3
R2270	7030004970	S.RES ERJ2GEJ 470 X (47)	T	76.6/101.8
R2271	7030004990	S.RES ERJ2GEJ 221 X (220)	T	76.6/100.9
R2272	7030004990	S.RES ERJ2GEJ 221 X (220)	B	78.1/97.8
R2273	7030004990	S.RES ERJ2GEJ 221 X (220)	B	78.1/98.9
R2274	7030005000	S.RES ERJ2GEJ 471 X (470)	T	14.1/89.7
R2277	7030005090	S.RES ERJ2GEJ 104 X (100K)	T	19.2/89.5
R2278	7030005090	S.RES ERJ2GEJ 104 X (100K)	T	19.2/90.4
R2279	7030005120	S.RES ERJ2GEJ 102 X (1K)	T	66.2/107
R2280	7030004980	S.RES ERJ2GEJ 101 X (100)	B	69.7/110.2
R2281	7030004990	S.RES ERJ2GEJ 221 X (220)	T	7.1/101.5
R2301	7030007250	S.RES ERJ2GEJ 220 X (22)	T	28.3/106.6
R2302	7030008290	S.RES ERJ2GEJ 183 X (18K)	T	28.9/108
R2303	7030005710	S.RES ERJ2GEJ 121 X (120)	T	31.2/110.8
R2304	7030010900	S.RES ERJ3GEVJ 750 V (75)	T	77.7/112
R2311	7030006101	S.RES ERA3YED 183V (18K)	B	67.6/107.1
R2312	7030006571	S.RES ERA3YED 392V (3.9K)	B	68.5/108.3
R2401	7030005000	S.RES ERJ2GEJ 471 X (470)	B	78.7/29.6
R2402	7030005050	S.RES ERJ2GEJ 103 X (10K)	B	81.3/29.6
R2405	7030010040	S.RES ERJ2GEJ-JPW	T	91.9/5.8
R2406	7030004990	S.RES ERJ2GEJ 221 X (220)	B	90.3/100.7
R2408	7030004970	S.RES ERJ2GEJ 470 X (47)	B	90.3/99.8
R2409	7030004990	S.RES ERJ2GEJ 221 X (220)	B	87.1/68.1
R2410	7030004990	S.RES ERJ2GEJ 221 X (220)	B	90.3/65.5
R2411	7030004990	S.RES ERJ2GEJ 221 X (220)	B	87.3/67.2
R2412	7030004990	S.RES ERJ2GEJ 221 X (220)	B	91.3/68.5
R2413	7030004990	S.RES ERJ2GEJ 221 X (220)	B	87.3/66.3
R2414	7030004990	S.RES ERJ2GEJ 221 X (220)	B	90.3/64.6
R2415	7030004990	S.RES ERJ2GEJ 221 X (220)	B	87.3/65.4
R2416	7030004990	S.RES ERJ2GEJ 221 X (220)	B	90.3/63.7
R2417	7030010040	S.RES ERJ2GEJ-JPW	B	51.4/141.2
R2418	7030010040	S.RES ERJ2GEJ-JPW	T	93.7/7.8
R2501	7030005090	S.RES ERJ2GEJ 104 X (100K)	B	8.3/93.3
R2502	7030005090	S.RES ERJ2GEJ 104 X (100K)	B	8/95.1
R2503	7030008410	S.RES ERJ2GEJ 392 X (3.9K)	B	8/91.5
R2505	7030008410	S.RES ERJ2GEJ 392 X (3.9K)	B	10.6/89.2
R2506	7030005720	S.RES ERJ2GEJ 563 X (56K)	B	9.4/90
R2507	7030004980	S.RES ERJ2GEJ 101 X (100)	B	16.4/89.9
R2508	7030005120	S.RES ERJ2GEJ 102 X (1K)	B	10.4/88.3
R2509	7030005120	S.RES ERJ2GEJ 102 X (1K)	B	15.7/88.3
R2510	7030005120	S.RES ERJ2GEJ 102 X (1K)	B	17.4/92.8
R2513	7030005000	S.RES ERJ2GEJ 471 X (470)	B	15.8/94
R2551	7030005120	S.RES ERJ2GEJ 102 X (1K)	B	42.9/123.2
R2552	7030005120	S.RES ERJ2GEJ 102 X (1K)	B	42.9/122.3
R2555	7030004980	S.RES ERJ2GEJ 101 X (100)	B	51.4/119.3
R2556	7030005040	S.RES ERJ2GEJ 472 X (4.7K)	B	44.5/125.2
R2559	7030010040	S.RES ERJ2GEJ-JPW	B	49.5/124.6
R2560	7030008410	S.RES ERJ2GEJ 392 X (3.9K)	B	49.5/125.5
R2561	7030008410	S.RES ERJ2GEJ 392 X (3.9K)	B	52.9/124.7
R2562	7030008410	S.RES ERJ2GEJ 392 X (3.9K)	B	53.9/122.8
R2564	7030005090	S.RES ERJ2GEJ 104 X (100K)	B	46.1/126.1
R2565	7030009280	S.RES ERJ2GEJ 391 X	B	41.8/116.9
R2566	7030005050	S.RES ERJ2GEJ 103 X (10K)	B	59/126.8
R2567	7030005050	S.RES ERJ2GEJ 103 X (10K)	B	60.6/126.8
R2568	7030005040	S.RES ERJ2GEJ 472 X (4.7K)	B	47.8/124.7
R2569	7030005040	S.RES ERJ2GEJ 472 X (4.7K)	B	46.1/125.2
R2601	7030010040	S.RES ERJ2GEJ-JPW	B	66.7/123.4
R2602	7030005000	S.RES ERJ2GEJ 471 X (470)	B	57.2/122.6
R2603	7030005240	S.RES ERJ2GEJ 473 X (47K)	B	63.4/121.7
R2604	7030008400	S.RES ERJ2GEJ 182 X (1.8K)	B	66.7/124.3
R2605	7030005120	S.RES ERJ2GEJ 102 X (1K)	B	65.5/126
R2607	7030010040	S.RES ERJ2GEJ-JPW	T	40.5/132.1
R2608	7030009320	S.RES ERJ2GEJ 4R7 X (4.7)	B	83.9/132.7
R2611	7030005050	S.RES ERJ2GEJ 103 X (10K)	B	33.9/124.8
R2612	7030005090	S.RES ERJ2GEJ 104 X (100K)	B	38.4/125.4
R2613	7030005080	S.RES ERJ2GEJ 823 X (82K)	B	38.4/123.6
R2614	7030005120	S.RES ERJ2GEJ 102 X (1K)	B	34.7/126.6
R2617	7030005040	S.RES ERJ2GEJ 472 X (4.7K)	T	63.3/111.1
R2618	7030007340	S.RES ERJ2GEJ 153 X (15K)	T	69.3/116.6
R2619	7030005060	S.RES ERJ2GEJ 333 X (33K)	T	63.3/112.1
R2620	7030005120	S.RES ERJ2GEJ 102 X (1K)	T	78.1/100.3
R2621	7030005120	S.RES ERJ2GEJ 102 X (1K)	T	78.1/99.4
R2623	7030005240	S.RES ERJ2GEJ 473 X (47K)	T	9.8/112.9
R2624	7030004970	S.RES ERJ2GEJ 470 X (47)	B	86.8/122
R2628	7030005240	S.RES ERJ2GEJ 473 X (47K)	B	61.8/121.7

[MAIN UNIT]

REF NO.	PARTS NO.	DESCRIPTION	M.	H/V LOCATION
C5	4030017460	S.CER ECJ0EB1E102K	B	47.5/30.7
C6	4030018960	S.CER C3216 JB 1C 106MT-N	T	66.3/12
C7	4030017330	S.CER ECJ0EF1C104Z	T	73.1/12.2
C8	4030017330	S.CER ECJ0EF1C104Z	T	77.2/9.1
C9	4030017330	S.CER ECJ0EF1C104Z	T	73.1/14
C10	4030017330	S.CER ECJ0EF1C104Z	T	74.8/14.9
C11	4030017330	S.CER ECJ0EF1C104Z	T	73/17.6
C12	4030017330	S.CER ECJ0EF1C104Z	T	76.4/16.7
C13	4030017330	S.CER ECJ0EF1C104Z	T	72.6/16.7
C14	4030017460	S.CER ECJ0EB1E102K	T	67.7/16.5
C15	4030017460	S.CER ECJ0EB1E102K	T	63.7/14.7
C16	4030017460	S.CER ECJ0EB1E102K	T	63.7/15.6
C17	4030017460	S.CER ECJ0EB1E102K	T	62.3/18.8
C18	4030017620	S.CER ECJ0EC1H100C	T	60.7/18.9
C21	4030017730	S.CER ECJ0EB1E471K	T	64.5/13.8
C25	4030017580	S.CER ECJ0EC1H060C	T	55.2/17.8
C26	4030017660	S.CER ECJ0EC1H330J	T	55.2/18.7
C27	4030017780	S.CER ECJ0EB1E472K	T	51.6/20.5
C28	4030017530	S.CER ECJ0EC1H0R5B	T	53.8/17.1
C29	4030017590	S.CER ECJ0EC1H070C	T	51.7/19.6
C30	4030017730	S.CER ECJ0EB1E471K	T	45.8/17.5
C31	4030017530	S.CER ECJ0EC1H0R5B	T	53.8/16.2
C32	4030017660	S.CER ECJ0EC1H330J	T	52.1/17.4
C33	4030017580	S.CER ECJ0EC1H060C	T	52.2/16.5
C34	4030017380	S.CER ECJ0EC1H050B	T	56/15
C35	4030017380	S.CER ECJ0EC1H050B	T	55.9/12.4
C36	4030017730	S.CER ECJ0EB1E471K	T	51/15.6
C37	4030017780	S.CER ECJ0EB1E472K	T	70.4/11.3
C38	4030017780	S.CER ECJ0EB1E472K	T	45.8/18.4
C40	4030017730	S.CER ECJ0EB1E471K	T	73.1/13.1
C41	4030017730	S.CER ECJ0EB1E471K	T	66.9/19.6
C42	4030017730	S.CER ECJ0EB1E471K	T	70.4/12.2
C43	4030017420	S.CER ECJ0EC1H470J	T	45.8/16.6
C44	4030017420	S.CER ECJ0EC1H470J	T	48/11.7
C50	4030017640	S.CER ECJ0EC1H150J	B	80.4/13.6
C51	4030017640	S.CER ECJ0EC1H150J	B	79.9/11.8
C52	4030017430	S.CER ECJ0EC1H101J	B	79.9/12.7
C53	4030016930	S.CER ECJ0EB1A104K	B	79.6/22
C54	4030016930	S.CER ECJ0EB1A104K	T	79.8/12.9
C55	4030016930	S.CER ECJ0EB1A104K	T	78.1/17.9
C56	4030018860	S.CER ECJ0EB0J105K	B	65.5/22.7
C58	4030017710	S.CER ECJ0EC1H181J	T	72.2/19.4
C59	4030017710	S.CER ECJ0EC1H181J	T	65.4/23.7
C101	4030017330	S.CER ECJ0EF1C104Z	T	10.3/15.5
C102	4030017330	S.CER ECJ0EF1C104Z	T	13.2/16.9
C103	4030017330	S.CER ECJ0EF1C104Z	T	13.2/17.8
C104	4030017330	S.CER ECJ0EF1C104Z	T	3.3/29.9
C105	4030017330	S.CER ECJ0EF1C104Z	T	13.2/19.6
C106	4030017850	S.CER C2012 CH 1H 272J-T	T	23.7/10.9
C107	4030017330	S.CER ECJ0EF1C104Z	T	19.2/12.9
C108	4030017330	S.CER ECJ0EF1C104Z	T	36.5/16.6
C109	4030017330	S.CER ECJ0EF1C104Z	T	25.2/14
C110	4030017800	S.CER C1608 CH 1H 561J-T	T	27.8/7.7
C111	4030018590	S.CER C1608 CH 1H 122J-T	T	29.1/5
C112	4030017330	S.CER ECJ0EF1C104Z	T	23.8/5.3
C114	4030018600	S.CER C1608 CH 1H 152J-T	T	25.1/15
C115	4030008490	S.CER C2012 JB 1H 682K-T	T	24.8/16.7
C116	4030017850	S.CER C2012 CH 1H 272J-T	T	24.8/18.4
C117	4030017330	S.CER ECJ0EF1C104Z	T	19.8/7
C118	4030017330	S.CER ECJ0EF1C104Z	T	38.2/17.5
C119	4030017780	S.CER ECJ0EB1E472K	T	7.8/22.2
C120	4030017330	S.CER ECJ0EF1C104Z	T	7.8/21.3
C121	4030017330	S.CER ECJ0EF1C104Z	T	5.7/12.9
C122	4030017330	S.CER ECJ0EF1C104Z	T	13.2/18.7
C123	4030017330	S.CER ECJ0EF1C104Z	T	15.4/14.3
C124	4030017330	S.CER ECJ0EF1C104Z	T	16.3/15.3
C125	4030017460	S.CER ECJ0EB1E102K	T	40/21.7
C126	4030017460	S.CER ECJ0EB1E102K	T	37/22.3
C127	4030017460	S.CER ECJ0EB1E102K	B	19.2/23
C208	4030017330	S.CER ECJ0EF1C104Z	T	19.7/31.2
C209	4030017680	S.CER ECJ0EC1H820J	T	18.5/41.4
C210	4030017610	S.CER ECJ0EC1H090C	T	18.5/40.5
C211	4030017700	S.CER ECJ0EC1H151J	T	18.5/42.3
C212	4030017650	S.CER ECJ0EC1H270J	T	23.2/39.2
C213	4030017510	S.CER ECJ0EC1H680J	T	21.8/43.4
C214	4030018820	S.CER ECJ0EB1H561K	T	31.7/54.4
C215	4030017440	S.CER ECJ0EC1H221J	T	37/54.6
C226	4030017330	S.CER ECJ0EF1C104Z	T	24.1/43.4
C227	4030017330	S.CER ECJ0EF1C104Z	T	19.7/30.3
C228	4030017430	S.CER ECJ0EC1H101J	T	28.1/39.2
C229	4030017440	S.CER ECJ0EC1H221J	T	29.7/39.2
C237	4030017500	S.CER ECJ0EC1H560J	T	28.1/38.2
C238	4030017330	S.CER ECJ0EF1C104Z	T	21.9/30.9
C239	4030017330	S.CER ECJ0EF1C104Z	B	24.7/41.4
C240	4030017400	S.CER ECJ0EC1H220J	B	28.1/43.6
C241	4030017580	S.CER ECJ0EC1H060C		

[MAIN UNIT]

REF NO.	PARTS NO.	DESCRIPTION	M.	H/V LOCATION
C255	4030018580	S.CER C1608 CH 1H 821J-T	T	32.6/55.9
C256	4030010760	S.CER C1608 CH 1H 331J-T	T	38.1/52.1
C257	4030018610	S.CER C1608 CH 1H 182J-T	T	34.4/53.4
C258	4030017870	S.CER C1608 CH 1H 681J-T	T	40.7/52.2
C259	4030018590	S.CER C1608 CH 1H 122J-T	T	37.1/53.4
C260	4030017870	S.CER C1608 CH 1H 681J-T	T	40.7/47.9
C261	4030017780	S.CER ECJ0EB1E472K	B	37.9/56.2
C262	4030017780	S.CER ECJ0EB1E472K	B	37.9/53.8
C263	4030017330	S.CER ECJ0EF1C104Z	B	24.5/50.2
C264	4030017330	S.CER ECJ0EF1C104Z	B	23.9/47.1
C265	4030011280	S.CER C1608 CH 1H 271J-T	B	36.4/46
C266	4030017700	S.CER ECJ0EC1H151J	B	31/44.1
C267	4030018590	S.CER C1608 CH 1H 122J-T	B	36.4/49.6
C268	4030018580	S.CER C1608 CH 1H 821J-T	B	31.7/42.9
C269	4030017710	S.CER ECJ0EC1H181J	B	36.5/47.1
C270	4030017430	S.CER ECJ0EC1H101J	B	32.6/44.1
C271	4030011330	S.CER C1608 CH 1H 391J-T	B	36.4/48.3
C272	4030011280	S.CER C1608 CH 1H 271J-T	B	36.3/43.8
C273	4030011330	S.CER C1608 CH 1H 391J-T	B	38.8/47.3
C274	4030017730	S.CER ECJ0EB1E471K	B	34.2/43.7
C275	4030017780	S.CER ECJ0EB1E472K	B	42.9/49.6
C276	4030017780	S.CER ECJ0EB1E472K	B	39.2/46.2
C278	4030017330	S.CER ECJ0EF1C104Z	T	30.9/31.8
C279	4030017330	S.CER ECJ0EF1C104Z	T	31/43.8
C281	4030017330	S.CER ECJ0EF1C104Z	T	33/31.7
C282	4030017580	S.CER ECJ0EC1H060C	B	31.5/39.2
C283	4030017330	S.CER ECJ0EF1C104Z	B	35.8/35.8
C284	4030017780	S.CER ECJ0EB1E472K	B	42.6/43.3
C285	4030017380	S.CER ECJ0EC1H050B	B	33.1/39.5
C286	4030017510	S.CER ECJ0EC1H680J	B	34.7/39.5
C287	4030017690	S.CER ECJ0EC1H121J	B	36.5/37.8
C288	4030017680	S.CER ECJ0EC1H820J	B	34.2/36.3
C289	4030017420	S.CER ECJ0EC1H470J	B	36.3/36.7
C290	4030018600	S.CER C1608 CH 1H 152J-T	B	38.8/37.6
C291	4030017680	S.CER ECJ0EC1H820J	B	37.9/36.5
C292	4030017330	S.CER ECJ0EF1C104Z	T	30.9/30
C293	4030017780	S.CER ECJ0EB1E472K	B	38.1/34.8
C294	4030017440	S.CER ECJ0EC1H221J	T	38.6/49.6
C295	4030017510	S.CER ECJ0EC1H680J	T	40.4/51.2
C301	4030017330	S.CER ECJ0EF1C104Z	T	47/30.1
C302	4030017330	S.CER ECJ0EF1C104Z	B	56.1/30.7
C303	4030017330	S.CER ECJ0EF1C104Z	T	51.5/33.6
C305	4030017330	S.CER ECJ0EF1C104Z	T	59.9/34.7
C307	4030017330	S.CER ECJ0EF1C104Z	T	59.9/35.6
C308	4030017330	S.CER ECJ0EF1C104Z	T	60.7/36.5
C309	4030017330	S.CER ECJ0EF1C104Z	T	62.8/36.9
C310	4030017330	S.CER ECJ0EF1C104Z	T	60.9/30.1
C311	4030017330	S.CER ECJ0EF1C104Z	T	50.1/32.6
C312	4030017330	S.CER ECJ0EF1C104Z	T	64.5/36.1
C313	4030017380	S.CER ECJ0EC1H050B	T	46.4/23
C314	4030017660	S.CER ECJ0EC1H330J	T	64.8/35.2
C315	4030017340	S.CER ECJ0EC1H010B	T	49.2/22.9
C316	4030017630	S.CER ECJ0EC1H120J	T	66.1/36.1
C317	4030017600	S.CER ECJ0EC1H080C	T	51.4/23.8
C318	4030017680	S.CER ECJ0EF1H820J	T	66.4/35.2
C319	4030017570	S.CER ECJ0EC1H040B	T	53/24.3
C320	4030017570	S.CER ECJ0EC1H040B	T	69.6/37.1
C321	4030017580	S.CER ECJ0EC1H060C	T	58.6/24.4
C322	4030017670	S.CER ECJ0EC1H390J	T	69/32.2
C323	4030017590	S.CER ECJ0EC1H070C	T	60.4/24.2
C324	4030017330	S.CER ECJ0EF1C104Z	T	74.7/38.6
C325	4030017360	S.CER ECJ0EC1H030B	T	62/24.6
C326	4030017780	S.CER ECJ0EB1E472K	T	47.6/47.1
C401	4030017330	S.CER ECJ0EF1C104Z	T	71/30.8
C413	4030017330	S.CER ECJ0EF1C104Z	T	80.6/23.9
C415	4030017330	S.CER ECJ0EF1C104Z	T	71.9/24
C418	4030017330	S.CER ECJ0EF1C104Z	T	67.4/24.8
C422	4030017330	S.CER ECJ0EF1C104Z	T	80/28.6
C423	4030017330	S.CER ECJ0EF1C104Z	T	67.4/23.9
C424	4030017330	S.CER ECJ0EF1C104Z	T	83.2/21
C425	4030017330	S.CER ECJ0EF1C104Z	T	86.9/27.6
C426	4030017330	S.CER ECJ0EF1C104Z	T	78.6/19.8
C427	4030017330	S.CER ECJ0EF1C104Z	T	80/27.7
C429	4030017460	S.CER ECJ0EB1E102K	T	81.8/25.3
C431	4030017330	S.CER ECJ0EF1C104Z	T	88.5/26.7
C432	4030017780	S.CER ECJ0EB1E472K	B	88.5/19.3
C433	4030017780	S.CER ECJ0EB1E472K	T	88.8/20.3
C434	4030017780	S.CER ECJ0EB1E472K	T	86.7/22.9
C511	4030017460	S.CER ECJ0EB1E102K	T	41.8/26.8
C512	4030017780	S.CER ECJ0EB1E472K	T	93.6/33.5
C513	4030017330	S.CER ECJ0EF1C104Z	T	88.4/28.3
C514	4030017330	S.CER ECJ0EF1C104Z	B	88.3/31.7
C515	4030017780	S.CER ECJ0EB1E472K	T	81.7/33.2
C516	4030017580	S.CER ECJ0EC1H060C	T	86.1/38.7
C518	4030017570	S.CER ECJ0EC1H040B	T	86.9/36.5
C525	4030017330	S.CER ECJ0EF1C104Z	T	81.8/32.3
C526	4030016790	S.CER ECJ0EB1C103K	T	77.9/38.2
C527	4030017330	S.CER ECJ0EF1C104Z	T	79.5/37.9
C528	4030017330	S.CER ECJ0EF1C104Z	T	89.7/35.1
C529	4030017670	S.CER ECJ0EC1H390J	T	91.3/33.8
C530	4030017460	S.CER ECJ0EB1E102K	B	87.7/34.1
C602	4030017570	S.CER ECJ0EC1H040B	B	85.7/39.6
C603	4030017780	S.CER ECJ0EB1E472K	T	89.1/40.1
C604	4030017780	S.CER ECJ0EB1E472K	T	94/46.5
C605	4030017620	S.CER ECJ0EC1H100C	T	86/44.2
C606	4030017620	S.CER ECJ0EC1H100C	B	85.7/41.4
C608	4030017550	S.CER ECJ0EC1H1R5B	B	82.7/43.8
C609	4030017580	S.CER ECJ0EC1H060C	B	78.6/46.8
C610	4030017620	S.CER ECJ0EC1H100C	B	80.7/48.1

[MAIN UNIT]

REF NO.	PARTS NO.	DESCRIPTION	M.	H/V LOCATION
C611	4030017780	S.CER ECJ0EB1E472K	B	85.1/37.5
C612	4030017610	S.CER ECJ0EC1H090C	T	79.5/40.5
C613	4030017620	S.CER ECJ0EC1H100C	T	76.5/43.7
C614	4030017780	S.CER ECJ0EB1E472K	T	69.6/38.8
C615	4030017780	S.CER ECJ0EB1E472K	T	64.3/43
C616	4030017780	S.CER ECJ0EB1E472K	T	77.4/39.5
C617	4030017620	S.CER ECJ0EC1H100C	B	85.7/40.5
C618	4030017620	S.CER ECJ0EC1H100C	B	80.7/49
C701	4030017330	S.CER ECJ0EF1C104Z	T	59/50.6
C702	4030017330	S.CER ECJ0EF1C104Z	T	63/45
C703	4510008630	S.ELE 16 CE 47 FE	B	59/44.9
C704	4030017780	S.CER ECJ0EB1E472K	T	58.6/42.9
C705	4030017600	S.CER ECJ0EC1H080C	T	59.6/45.1
C707	4030017330	S.CER ECJ0EF1C104Z	T	64.2/52.9
C708	4030017460	S.CER ECJ0EB1E102K	T	64.5/55
C709	4030017780	S.CER ECJ0EB1E472K	T	60.7/58.6
C710	4030017780	S.CER ECJ0EB1E472K	T	62.3/58.6
C711	4030017460	S.CER ECJ0EB1E102K	T	57.1/50.6
C712	4030017600	S.CER ECJ0EC1H080C	T	52.4/50.2
C714	4030017460	S.CER ECJ0EB1E102K	T	56.2/49.7
C715	4030017780	S.CER ECJ0EB1E472K	T	52.1/53.2
C716	4030017340	S.CER ECJ0EC1H010B	T	55.3/55.1
C717	4030017780	S.CER ECJ0EB1E472K	T	51.2/52.3
C718	4030017780	S.CER ECJ0EB1E472K	T	56.9/55.1
C719	4030017340	S.CER ECJ0EC1H010B	T	61.1/53.9
C720	4030017380	S.CER ECJ0EC1H050B	T	59.3/42
C721	4030017780	S.CER ECJ0EB1E472K	T	51.2/49.6
C801	4030017330	S.CER ECJ0EF1C104Z	T	71.5/64
C803	4030017780	S.CER ECJ0EB1E472K	T	65.3/61.8
C804	4030017330	S.CER ECJ0EF1C104Z	T	91.9/58
C805	4030017460	S.CER ECJ0EB1E102K	T	83.5/55.8
C807	4030017330	S.CER ECJ0EF1C104Z	T	60.6/66.7
C808	4030017870	S.CER C1608 CH 1H 681J-T	T	60.3/65.5
C809	4030018630	S.CER C2012 CH 1H 472J-T	T	57.4/66.8
C810	4030017700	S.CER ECJ0EC1H151J	T	63.9/68.5
C811	4030017700	S.CER ECJ0EC1H151J	T	63.9/69.4
C812	4030017700	S.CER ECJ0EC1H151J	T	60.1/69.4
C813	4030017700	S.CER ECJ0EC1H151J	T	60.1/68.5
C814	4030017330	S.CER ECJ0EF1C104Z	T	88.5/57.1
C815	4030017460	S.CER ECJ0EB1E102K	T	86.6/60.6
C816	4030017400	S.CER ECJ0EC1H220J	T	85.7/59.7
C817	4030017400	S.CER ECJ0EC1H220J	T	84/61.7
C818	4030018590	S.CER C1608 CH 1H 122J-T	T	54.6/65.6
C819	4030017850	S.CER C2012 CH 1H 272J-T	T	51.6/65.8
C901	4030017330	S.CER ECJ0EF1C104Z	T	38.4/71.3
C910	4030017710	S.CER ECJ0EC1H181J	T	39.2/65.6
C911	4030017700	S.CER ECJ0EC1H151J	T	47.9/74.7
C913	4030017330	S.CER ECJ0EF1C104Z	T	38.2/61.1
C914	4030017330	S.CER ECJ0EF1C104Z	T	39.2/63.6
C916	4030017330	S.CER ECJ0EF1C104Z	T	33.9/61.9
C917	4030017780	S.CER ECJ0EB1E472K	T	35.6/63.2
C918	4030017330	S.CER ECJ0EF1C104Z	T	34.2/67.5
C920	4030017460	S.CER ECJ0EB1E102K	T	38.4/74.2
C921	4030017330	S.CER ECJ0EF1C104Z	T	34.2/70.2
C922	4030017330	S.CER ECJ0EF1C104Z	T	29.4/73
C923	4030017330	S.CER ECJ0EF1C104Z	T	29.9/72.1
C924	4030017780	S.CER ECJ0EB1E472K	T	41.2/74.1
C925	4030017700	S.CER ECJ0EC1H151J	B	31.4/73
C1001	4030017780	S.CER ECJ0EB1E472K	T	31.7/71.2
C1009	4030017780	S.CER ECJ0EB1E472K	T	25.8/72
C1016	4030017330	S.CER ECJ0EF1C104Z	T	25.8/73.8
C1018	4030017460	S.CER ECJ0EB1E102K	T	20.3/76
C1019	4030017330	S.CER ECJ0EF1C104Z	T	15.2/75.7
C1020	4030017330	S.CER ECJ0EF1C104Z	T	12.7/75.8
C1021	4030017330	S.CER ECJ0EF1C104Z	T	4.6/78.9
C1022	4510008630	S.ELE 16 CE 47 FE	B	6.1/86
C1023	4510008630	S.ELE 16 CE 47 FE	B	5.7/77.4
C1101	4030017490	S.CER C1608 JB 1A 105K-T	T	2.5/78.9
C1102	4030017330	S.CER ECJ0EF1C104Z	T	4.6/78
C1104	4030017490	S.CER C1608 JB 1A 105K-T	T	2.5/87.8
C1105	4030018960	S.CER C3216 JB 1C 106MT-N	T	2.9/89.7
C1108	4030017330	S.CER ECJ0EF1C104Z	T	2.3/91.3
C1201	4030017330	S.CER ECJ0EF1C104Z	T	26.6/80.6
C1202	4030017330	S.CER ECJ0EF1C104Z	T	28.7/80.5
C1203	4030017330	S.CER ECJ0EF1C104Z	T	18.6/79.2
C1204	4030018960	S.CER C3216 JB 1C 106MT-N	T	9/76.9
C1206	4030017780	S.CER ECJ0EB1E472K	T	14.3/79.4
C1207	4030017780	S.CER ECJ0EB1E472K	T	12.7/78.5
C1208	4030018800	S.CER ECJ0EB1H182K	T	12.9/85
C1209	4030018820	S.CER ECJ0EB1H561K	T	12.9/84.1
C1210	4030017780	S.CER ECJ0EB1E472K	T	11.3/84.1
C1211	4030017490	S.CER C1608 JB 1A 105K-T	T	9.2/84.5
C1212	4030017490	S.CER C1608 JB 1A 105K-T	T	6.7/87.8
C1213	4030017330	S.CER ECJ0EF1C104Z	T	21.8/78.3
C1301	4030017330	S.CER ECJ0EF1C104Z	T	15.2/73.6
C1302	4030017330	S.CER ECJ0EF1C104Z	T	15.1/67.3
C1303	4030018860	S.CER ECJ0EB0J105K	T	11.3/67.3
C1304	4030017330	S.CER ECJ0EF1C104Z	T	14.3/69.2
C1305	4030017330	S.CER ECJ0EF1C104Z	T	1

[MAIN UNIT]

REF NO.	PARTS NO.	DESCRIPTION	M.	H/V LOCATION
C1404	4030017700	S.CER ECJ0EC1H151J	B	41.9/70.5
C1405	4030017780	S.CER ECJ0EB1E472K	B	43.6/71.4
C1406	4030017780	S.CER ECJ0EB1E472K	B	42/72.4
C1407	4030017780	S.CER ECJ0EB1E472K	B	44.6/74.3
C1408	4030017780	S.CER ECJ0EB1E472K	B	40.3/79
C1409	4030017780	S.CER ECJ0EB1E472K	B	34.7/79
C1411	4030018860	S.CER ECJ0EB0J105K	B	27/79.9
C1412	4030016950	S.CER ECJ0EB1A473K	B	27/80.8
C1413	4030017490	S.CER C1608 JB 1A 105K-T	B	20.7/77.4
C1414	4030016950	S.CER ECJ0EB1A473K	B	25/77.8
C1415	4510008640	S.ELE 6 CE 100 FE	B	13.2/81.2
C1416	4030016950	S.CER ECJ0EB1A473K	B	20.2/78.5
C1418	4030017350	S.CER ECJ0EC1H020B	B	23/86.6
C1419	4030018390	S.CER ECJ0EB1A563K	B	23/87.5
C1420	4030017420	S.CER ECJ0EC1H470J	B	17.8/83
C1421	4030018960	S.CER C3216 JB 1C 106MT-N	B	19.8/87.3
C1422	4030017640	S.CER ECJ0EC1H150J	B	17.8/82.1
C1423	4610001970	S.TRI TZC3P200A110R00	T	3.8/72.5
C1491	4030017670	S.CER ECJ0EC1H390J [EUR]	B	88.2/29.3
	4030017670	S.CER ECJ0EC1H390J [FRA]		
	4030017670	S.CER ECJ0EC1H390J [ESP]		
	4030017400	S.CER ECJ0EC1H220J [USA]		
	4030017670	S.CER ECJ0EC1H390J [EXP]		
	4030017670	S.CER ECJ0EC1H390J [ITR]		
	4030017670	S.CER ECJ0EC1H390J [UK]		
	4030017400	S.CER ECJ0EC1H220J [KOR]		
	4030017670	S.CER ECJ0EC1H390J [AUS]		
	4030017670	S.CER ECJ0EC1H390J [CHN]		
C1493	4030017660	S.CER ECJ0EC1H330J	B	86.1/33.7
C1494	4030017670	S.CER ECJ0EC1H390J [EUR]	B	83.6/34
	4030017670	S.CER ECJ0EC1H390J [FRA]		
	4030017670	S.CER ECJ0EC1H390J [ESP]		
	4030017420	S.CER ECJ0EC1H470J [USA]		
	4030017670	S.CER ECJ0EC1H390J [EXP]		
	4030017670	S.CER ECJ0EC1H390J [ITR]		
	4030017670	S.CER ECJ0EC1H390J [UK]		
	4030017420	S.CER ECJ0EC1H470J [KOR]		
	4030017670	S.CER ECJ0EC1H390J [AUS]		
	4030017670	S.CER ECJ0EC1H390J [CHN]		
C1495	4030011280	S.CER C1608 CH 1H 271J-T [EUR]	B	84/32.9
	4030011280	S.CER C1608 CH 1H 271J-T [FRA]		
	4030011280	S.CER C1608 CH 1H 271J-T [ESP]		
	4030010760	S.CER C1608 CH 1H 331J-T [USA]		
	4030011280	S.CER C1608 CH 1H 271J-T [EXP]		
	4030011280	S.CER C1608 CH 1H 271J-T [ITR]		
	4030011280	S.CER C1608 CH 1H 271J-T [UK]		
	4030010760	S.CER C1608 CH 1H 331J-T [KOR]		
	4030011280	S.CER C1608 CH 1H 271J-T [AUS]		
	4030011280	S.CER C1608 CH 1H 271J-T [CHN]		
C1496	4030017660	S.CER ECJ0EC1H330J	B	79.3/35.3
C1498	4030017670	S.CER ECJ0EC1H390J [EUR]	B	79.3/36.2
	4030017670	S.CER ECJ0EC1H390J [FRA]		
	4030017670	S.CER ECJ0EC1H390J [ESP]		
	4030017400	S.CER ECJ0EC1H220J [USA]		
	4030017670	S.CER ECJ0EC1H390J [EXP]		
	4030017670	S.CER ECJ0EC1H390J [ITR]		
	4030017670	S.CER ECJ0EC1H390J [UK]		
	4030017400	S.CER ECJ0EC1H220J [KOR]		
	4030017670	S.CER ECJ0EC1H390J [AUS]		
	4030017670	S.CER ECJ0EC1H390J [CHN]		
C1501	4030017410	S.CER ECJ0EC1H240J	B	79.3/37.1
C1503	4030017330	S.CER ECJ0EF1C104Z	B	78.9/61.9
C1504	4030017510	S.CER ECJ0EB1H680J	B	80.9/36.4
C1506	4030017780	S.CER ECJ0EB1E472K	B	92.1/28.8
C1507	4030017410	S.CER ECJ0EC1H240J	B	82.5/36.4
C1508	4030017780	S.CER ECJ0EB1E472K	B	77.3/38.6
C1509	4030017780	S.CER ECJ0EB1E472K	B	72.4/39.1
C1510	4030017780	S.CER ECJ0EB1E472K	B	72.4/41.2
C1511	4030016790	S.CER ECJ0EB1C103K	B	86.4/56.2
C1512	4030017780	S.CER ECJ0EB1E472K	B	77/41.6
C1513	4030018900	S.CER ECJ0EB0J474K	B	73.6/55.1
C1514	4030017780	S.CER ECJ0EB1E472K	B	73.5/42.1
C1515	4030018960	S.CER C3216 JB 1C 106MT-N	B	68.3/53.7
C1516	4030017330	S.CER ECJ0EF1C104Z	B	77.3/49
C1517	4030017730	S.CER ECJ0EB1E471K	B	73.4/53.9
C1518	4030016790	S.CER ECJ0EB1C103K	B	85.7/51.4
C1519	4030018960	S.CER C3216 JB 1C 106MT-N	B	69.3/47.4
C1520	4510008630	S.ELE 16 CE 47 FE	B	91/45.4
C1521	4030017680	S.CER ECJ0EC1H820J	B	85.9/58
C1522	4030017670	S.CER ECJ0EC1H390J	T	73.2/55.3
C1523	4030017330	S.CER ECJ0EF1C104Z	T	31.2/80.4
C1524	4030017420	S.CER ECJ0EC1H470J [EUR]	B	73.6/60.5
	4030017420	S.CER ECJ0EC1H470J [FRA]		
	4030017420	S.CER ECJ0EC1H470J [ESP]		
	4030017510	S.CER ECJ0EC1H680J [USA]		
	4030017420	S.CER ECJ0EC1H470J [EXP]		
	4030017420	S.CER ECJ0EC1H470J [ITR]		
	4030017420	S.CER ECJ0EC1H470J [UK]		
	4030017510	S.CER ECJ0EC1H680J [KOR]		
	4030017420	S.CER ECJ0EC1H470J [AUS]		
	4030017420	S.CER ECJ0EC1H470J [CHN]		
C1525	4030018900	S.CER ECJ0EB0J474K	B	85.8/59.9
C1526	4030018960	S.CER C3216 JB 1C 106MT-N	B	69.3/51.5
C1531	4030017490	S.CER C1608 JB 1A 105K-T	B	82.8/48.3
C1532	4030017780	S.CER ECJ0EB1E472K	B	81.9/41.3
C1533	4030017780	S.CER ECJ0EB1E472K	B	81.9/39.4
C1534	4030017780	S.CER ECJ0EB1E472K	B	83.5/38.5
C1601	4030017780	S.CER ECJ0EB1E472K	T	6.3/52.2
C1604	4030017780	S.CER ECJ0EB1E472K	T	5.6/50.8

[MAIN UNIT]

REF NO.	PARTS NO.	DESCRIPTION	M.	H/V LOCATION
C1605	4030017330	S.CER ECJ0EF1C104Z	T	8.8/48.7
C1607	4030017780	S.CER ECJ0EB1E472K	T	14.7/46
C1609	4030017490	S.CER C1608 JB 1A 105K-T	T	14.1/33.6
C1610	4030017330	S.CER ECJ0EF1C104Z	T	12.1/44.7
C1611	4030017330	S.CER ECJ0EF1C104Z	T	14.6/41.1
C1613	4030017330	S.CER ECJ0EF1C104Z	T	18.9/47.1
C1614	4030017730	S.CER ECJ0EB1E471K	T	15/36.1
C1615	4030017420	S.CER ECJ0EC1H470J	T	10.4/46.9
C1616	4550007260	S.TAN F931C475MAABMA	T	9.6/50.5
C1618	4030017430	S.CER ECJ0EC1H101J	T	12.7/26.3
C1701	4030017490	S.CER C1608 JB 1A 105K-T	B	55.1/50.4
C1702	4030017490	S.CER C1608 JB 1A 105K-T	B	55/69.6
C1801	4030017330	S.CER ECJ0EF1C104Z	B	18.4/105
C1802	4510008630	S.ELE 16 CE 47 FE	B	14.4/101.2
C1803	4030018960	S.CER C3216 JB 1C 106MT-N	B	22.3/112.1
C1804	4030017330	S.CER ECJ0EF1C104Z	B	22.8/110.6
C1901	4030017330	S.CER ECJ0EF1C104Z	T	36.2/80.4
C1902	4030017330	S.CER ECJ0EF1C104Z	T	33.7/80.4
C1903	4030017330	S.CER ECJ0EF1C104Z	B	23.3/18.8
C1904	4030017330	S.CER ECJ0EF1C104Z	B	32.5/89.8
C1905	4030017330	S.CER ECJ0EF1C104Z	B	25.9/33.8
C1906	4030017330	S.CER ECJ0EF1C104Z	B	25.9/32.9
C1907	4030017330	S.CER ECJ0EF1C104Z	T	41.6/80.3
C1908	4030017330	S.CER ECJ0EF1C104Z	T	38.4/80.7
C1909	4030017330	S.CER ECJ0EF1C104Z	B	21.6/13.9
C1910	4030017460	S.CER ECJ0EB1E102K	B	45.4/25.4
C1916	4030018960	S.CER C3216 JB 1C 106MT-N	B	14.7/50.5
C1917	4030018960	S.CER C3216 JB 1C 106MT-N	B	5.3/52.7
C1951	4030018960	S.CER C3216 JB 1C 106MT-N	B	48.1/103.1
C1952	4030018960	S.CER C3216 JB 1C 106MT-N	B	48.1/98.9
C1953	4030018960	S.CER C3216 JB 1C 106MT-N	B	48.1/96.8
C1954	4030018960	S.CER C3216 JB 1C 106MT-N	B	48.6/105.2
C1955	4030018960	S.CER C3216 JB 1C 106MT-N	B	48.1/101
C1956	4030018960	S.CER C3216 JB 1C 106MT-N	B	60.9/118.7
C1957	4030017330	S.CER ECJ0EF1C104Z	B	63.8/116.7
C1958	4030018910	S.CER C1608 JB 0J 475K-T	B	20.9/125.7
C1959	4550007090	S.TAN TEESVA 1A 226M8R	B	11.6/120.2
C1960	4030010210	S.CER C3216 JB 1C 105M-T	B	47.3/109.7
C1961	4030017730	S.CER ECJ0EB1E471K	B	44/110
C1962	4030017440	S.CER ECJ0EC1H221J	B	44.6/108.4
C1963	4030017500	S.CER ECJ0EC1H560J	B	35.3/105.1
C1964	4030017330	S.CER ECJ0EF1C104Z	B	44.3/111.3
C1965	4030018960	S.CER C3216 JB 1C 106MT-N	B	7.4/108
C1966	4030017330	S.CER ECJ0EF1C104Z	B	10.1/103
C1968	4030018960	S.CER C3216 JB 1C 106MT-N	B	31.7/103.6
C1969	4030018970	S.CER C3225 JB 1C 226MT-N	B	30.8/100.9
C1970	4030018970	S.CER C3225 JB 1C 226MT-N	B	30.8/97.9
C1971	4030017330	S.CER ECJ0EF1C104Z	B	45.9/111.3
C1972	4030017330	S.CER ECJ0EF1C104Z	B	47.6/106.7
C1973	4030017330	S.CER ECJ0EF1C104Z	B	32.1/105.1
C2001	4030017780	S.CER ECJ0EB1E472K	T	33.2/10.3
C2002	4030017330	S.CER ECJ0EF1C104Z	B	71.7/14.6
C2003	4030017780	S.CER ECJ0EB1E472K	B	58.8/15.8
C2004	4030017780	S.CER ECJ0EB1E472K	B	83/5.9
C2005	4030017780	S.CER ECJ0EB1E472K	B	69/16.4
C2006	4030017330	S.CER ECJ0EF1C104Z	B	83/6.8
C2007	4030017780	S.CER ECJ0EB1E472K	B	84.6/5.9
C2008	4030017330	S.CER ECJ0EF1C104Z	B	56.7/10.1
C2009	4030017330	S.CER ECJ0EF1C104Z	B	75.4/18.6
C2010	4030017780	S.CER ECJ0EB1E472K	B	75.6/6.6
C2011	4030017330	S.CER ECJ0EF1C104Z	B	75/7.7
C2012	4030017780	S.CER ECJ0EB1E472K	B	63.1/15.5
C2013	4030017330	S.CER ECJ0EF1C104Z	B	88.9/2
C2014	4030017780	S.CER ECJ0EB1E472K	B	32.5/11.8
C2015	4030017780	S.CER ECJ0EB1E472K	B	32.5/12.7
C2016	4030017780	S.CER ECJ0EB1E472K	B	19/131.2
C2017	4030017330	S.CER ECJ0EF1C104Z	T	86.4/10.2
C2018	4030017780	S.CER ECJ0EB1E472K	B	42.7/17.7
C2019	4030017780	S.CER ECJ0EB1E472K	T	24.7/126.7
C2020	4030017330	S.CER ECJ0EF1C104Z	B	84.1/23.1
C2021	4030017780	S.CER ECJ0EB1E472K	B	32.5/16
C2022	4030017780	S.CER ECJ0EB1E472K	B	30.3/130.2
C2024	4030017780	S.CER ECJ0EB1E472K	B	28.7/128.2
C2025	4030017780	S.CER ECJ0EB1E472K	B	45/12.5
C2026	4030018960	S.CER C3216 JB 1C 106MT-N	B	10.1/23.4
C2027	4030018960	S.CER C3216 JB 1C 106MT-N	B	10.1/14.6
C2028	4030017330	S.CER ECJ0EF1C104Z	B	51.7/12.7
C2029	4030017330	S.CER ECJ0EF1C104Z	B	58.1/9.4
C2030	4030017330	S.CER ECJ0EF1C104Z	B	55.8/15.8
C2032	4030017780	S.CER ECJ0EB1E472K	B	27.4/129
C2033	4030017330	S.CER ECJ0EF1C104Z	B	71.1/21.9
C2034	4030017780	S.CER ECJ0EB1E472K	B	64.8/5.6
C2035	4030017780	S.CER ECJ0EB1E472K	B	25.6/130.2
C2036	4030017330	S.CER ECJ0EF1C104Z	B	88.2/8
C2037	4030017330	S.CER ECJ0EF1C104Z	B	76.4/16.6
C2038	4030017780	S.CER ECJ0EB1E472K	T	14.5/126.4
C2039	4030017780	S.CER ECJ0EB1E472K	B	80.2/6.7
C2040	4030017780	S.CER ECJ0EB1E472K	B	64.6/17.7
C2041	4030017330	S.CER ECJ0EF1C104Z	B	75.2/10.5
C2042	4030017330	S.CER ECJ0EF1C104Z	B	62.7/18.1
C2043	4030017780	S.CER ECJ0EB1E472K	B	55.4/8.8
C2044	4030017780	S.CER ECJ0EB1E472K	B	62.7/19.5
C2045	4030017780	S.CER ECJ0EB1E472K	B	64.3/21.8
C2046	4030017780	S.CER ECJ0EB1E472K	B	63.6/14.6

[MAIN UNIT]

REF NO.	PARTS NO.	DESCRIPTION	M.	H/V LOCATION
C2052	4030017780	S.CER ECJ0EB1E472K	T	21.6/108
C2053	4030017780	S.CER ECJ0EB1E472K	T	49.8/107.5
C2054	4030018960	S.CER C3216 JB 1C 106MT-N	B	55.3/83.4
C2055	4030018960	S.CER C3216 JB 1C 106MT-N	B	28.1/88.5
C2058	4030018960	S.CER C3216 JB 1C 106MT-N	B	16.4/95.5
C2062	4550007710	S.TAN TEESVBE 1A 476M8R	B	26.6/13
C2063	4030017730	S.CER ECJ0EB1E471K	B	46/13.7
C2064	4030018960	S.CER C3216 JB 1C 106MT-N	B	61.1/23
C2065	4030016930	S.CER ECJ0EB1A104K	B	73.3/1.2
C2066	4030016930	S.CER ECJ0EB1A104K	B	75.1/1.2
C2067	4030017430	S.CER ECJ0EC1H101J	B	56.9/19.9
C2068	4030017460	S.CER ECJ0EB1E102K	B	59.1/26.1
C2069	4030017730	S.CER ECJ0EB1E471K	B	46.6/12.1
C2101	4030017330	S.CER ECJ0EF1C104Z	T	28.3/13.8
C2102	4030017330	S.CER ECJ0EF1C104Z	T	44.7/110.9
C2103	4030018960	S.CER C3216 JB 1C 106MT-N	T	28.8/112.2
C2104	4030017330	S.CER ECJ0EF1C104Z	T	56.1/123.5
C2105	4030018960	S.CER C3216 JB 1C 106MT-N	T	54.7/125
C2156	4030017330	S.CER ECJ0EF1C104Z	T	36.2/122.1
C2157	4030017330	S.CER ECJ0EF1C104Z	B	34.4/91
C2158	4030017330	S.CER ECJ0EF1C104Z	B	27.4/93.7
C2159	4030017330	S.CER ECJ0EF1C104Z	T	22.4/94.4
C2160	4030017330	S.CER ECJ0EF1C104Z	B	38.2/88.8
C2161	4030018960	S.CER C3216 JB 1C 106MT-N	T	36.8/123.6
C2162	4030018960	S.CER C3216 JB 1C 106MT-N	B	37.7/90.4
C2163	4030017780	S.CER ECJ0EB1E472K	T	4.6/116.5
C2164	4030018960	S.CER C3216 JB 1C 106MT-N	T	6.5/114.9
C2166	4030012610	S.CER C2012 JB 1C 474K-T	T	5.2/106.8
C2167	4030018960	S.CER C3216 JB 1C 106MT-N	T	4.9/109.9
C2168	4030012610	S.CER C2012 JB 1C 474K-T	T	16.5/116.8
C2169	4030016930	S.CER ECJ0EB1A104K	T	14/124.2
C2201	4030017780	S.CER ECJ0EB1E472K	T	24.7/125.8
C2203	4030018520	S.CER C1608 JB 0J 225M-T	T	16/118.4
C2204	4030017330	S.CER ECJ0EF1C104Z	T	11.1/119.7
C2205	4030018960	S.CER C3216 JB 1C 106MT-N	T	12.4/117.1
C2206	4030017780	S.CER ECJ0EB1E472K	T	21.7/115.6
C2208	4030017730	S.CER ECJ0EB1E471K	T	19/116.9
C2211	4030018960	S.CER C3216 JB 1C 106MT-N	T	22.4/119.9
C2212	4030018960	S.CER C3216 JB 1C 106MT-N	T	23.2/124.3
C2213	4550007140	S.TAN TEESVD 1C 107M12R	T	37.6/138.5
C2214	4030018910	S.CER C1608 JB 0J 475K-T	T	20.9/122.6
C2231	4030017330	S.CER ECJ0EF1C104Z	T	38.2/105.6
C2232	4030018960	S.CER C3216 JB 1C 106MT-N	T	38.1/104
C2233	4030017780	S.CER ECJ0EB1E472K	T	4.7/123.2
C2234	4550007310	S.TAN F930J227MNBMA	T	70.1/130.6
C2235	4030018960	S.CER C3216 JB 1C 106MT-N	T	40.9/108.8
C2236	4030018960	S.CER C3216 JB 1C 106MT-N	T	39.8/111.1
C2237	4030017460	S.CER ECJ0EB1E102K	T	60.6/123.3
C2254	4030017330	S.CER ECJ0EF1C104Z	T	7.6/92.5
C2255	4030017330	S.CER ECJ0EF1C104Z	B	2.4/98.1
C2256	4030017330	S.CER ECJ0EF1C104Z	B	2.6/95.6
C2257	4030017330	S.CER ECJ0EF1C104Z	T	9.9/87.9
C2260	4030017330	S.CER ECJ0EF1C104Z	T	18.5/103.6
C2261	4030017330	S.CER ECJ0EF1C104Z	T	6.7/104.4
C2262	4030017330	S.CER ECJ0EF1C104Z	T	58.5/100.3
C2264	4030017330	S.CER ECJ0EF1C104Z	T	61.8/88.9
C2266	4030017330	S.CER ECJ0EF1C104Z	T	72/85.2
C2268	4030017330	S.CER ECJ0EF1C104Z	T	68.5/89.4
C2269	4030017330	S.CER ECJ0EF1C104Z	B	78.4/92.4
C2270	4030017780	S.CER ECJ0EB1E472K	T	61.8/89.8
C2272	4030017330	S.CER ECJ0EF1C104Z	T	56.2/92.2
C2274	4030017330	S.CER ECJ0EF1C104Z	T	55.8/95
C2275	4030017330	S.CER ECJ0EF1C104Z	B	68.1/99.3
C2276	4030017330	S.CER ECJ0EF1C104Z	B	64.2/100.6
C2277	4030017330	S.CER ECJ0EF1C104Z	T	63.6/103.4
C2278	4030017330	S.CER ECJ0EF1C104Z	T	63.6/107.9
C2279	4030017330	S.CER ECJ0EF1C104Z	T	62.7/108.8
C2280	4030017420	S.CER ECJ0EC1H470J	T	51.8/37.9
C2281	4030017330	S.CER ECJ0EF1C104Z	T	68.5/90.3
C2282	4030017330	S.CER ECJ0EF1C104Z	B	80.4/93
C2283	4030017330	S.CER ECJ0EF1C104Z	B	81.6/92.1
C2285	4030017330	S.CER ECJ0EF1C104Z	T	50.8/99
C2286	4030017330	S.CER ECJ0EF1C104Z	T	14.1/88.8
C2301	4030018910	S.CER C1608 JB 0J 475K-T	T	30.8/106.9
C2302	4030018910	S.CER C1608 JB 0J 475K-T	T	27.8/109.4
C2303	4550007310	S.TAN F930J227MNBMA	T	84.4/110.3
C2311	4030017330	S.CER ECJ0EF1C104Z	B	68.1/110.2
C2312	4030018910	S.CER C1608 JB 0J 475K-T	B	67.3/104.9
C2401	4030017330	S.CER ECJ0EF1C104Z	B	90.8/103.8
C2402	4030017330	S.CER ECJ0EF1C104Z	B	81.2/100.7
C2403	4030017780	S.CER ECJ0EB1E472K	B	77.2/28.8
C2405	4030017330	S.CER ECJ0EF1C104Z	T	74.2/79.3
C2406	4030017460	S.CER ECJ0EB1E102K	B	88.5/99.7
C2407	4030017330	S.CER ECJ0EF1C104Z	T	74.1/78.2
C2408	4030017330	S.CER ECJ0EF1C104Z	B	84.9/96.1
C2409	4030017330	S.CER ECJ0EF1C104Z	T	75.6/77.6
C2410	4030017330	S.CER ECJ0EF1C104Z	B	88.5/85.8
C2411	4030017330	S.CER ECJ0EF1C104Z	B	81.1/96.4
C2412	4510008630	S.ELE 16 CE 47 FE	B	62.1/30.4
C2413	4030017330	S.CER ECJ0EF1C104Z	B	88.5/93.7
C2414	4030017780	S.CER ECJ0EB1E472K	T	84/95.6
C2415	4030017780	S.CER ECJ0EB1E472K	B	88.3/28
C2417	4030017330	S.CER ECJ0EF1C104Z	B	88.3/27.1
C2418	4030017330	S.CER ECJ0EF1C104Z	B	82.6/94
C2419	4030017330	S.CER ECJ0EF1C104Z	B	88.5/86.7
C2422	4030017330	S.CER ECJ0EF1C104Z	T	84.8/87.3
C2423	4030017420	S.CER ECJ0EC1H470J	B	62.1/141.2
C2424	4510008630	S.ELE 16 CE 47 FE	B	69.2/31.3
C2426	4030017330	S.CER ECJ0EF1C104Z	B	68.8/82.1

[MAIN UNIT]

REF NO.	PARTS NO.	DESCRIPTION	M.	H/V LOCATION
C2427	4030012600	S.CER C2012 JB 1A 105M-T	T	85.1/91.4
C2501	4030017330	S.CER ECJ0EF1C104Z	B	8/94.2
C2502	4030018960	S.CER C3216 JB 1C 106MT-N	B	11.5/95.2
C2503	4030016970	S.CER ECJ0EB1C223K	B	14.9/89.3
C2505	4030016940	S.CER ECJ0EB1A393K	B	17.4/91.4
C2506	4030017780	S.CER ECJ0EB1E472K	B	18.2/93.8
C2507	4030017490	S.CER C1608 JB 1A 105K-T	B	12.7/89.2
C2551	4030017330	S.CER ECJ0EF1C104Z	B	42.9/124.1
C2552	4030018960	S.CER C3216 JB 1C 106MT-N	B	47.8/118.8
C2553	4030016970	S.CER ECJ0EB1C223K	B	51.3/124.7
C2554	4030018390	S.CER ECJ0EB1A563K	B	53.9/121.9
C2555	4030017760	S.CER ECJ0EB1H222K	B	53.9/121
C2556	4030017770	S.CER ECJ0EB1E332K	B	52.8/123.8
C2557	4030017330	S.CER ECJ0EF1C104Z	B	41.7/120.8
C2558	4030018960	S.CER C3216 JB 1C 106MT-N	B	42.9/118.4
C2561	4030018960	S.CER C3216 JB 1C 106MT-N	B	56.5/124.3
C2562	4030018960	S.CER C3216 JB 1C 106MT-N	B	53.4/126.4
C2563	4550007110	S.TAN SY6-1A107M-RC	B	75.3/122.8
C2564	4030018080	S.CER ECJ0EB1H182K	B	47.8/125.6
C2565	4030017430	S.CER ECJ0EC1H101J	B	44.6/122.6
C2566	4030018090	S.CER ECJ0EB1C822K	B	46.2/124.3
C2601	4030017330	S.CER ECJ0EF1C104Z	B	59.7/125.1
C2603	4030010210	S.CER C3216 JB 1C 105M-T	B	87.5/126
C2604	4030016970	S.CER ECJ0EB1C223K	B	89.1/128.6
C2605	4030017330	S.CER ECJ0EF1C104Z	B	83.9/133.7
C2606	4510009250	S.ELE EEEFK1C471P	T	69.2/137.4
C2607	4510008650	S.ELE EEEFK1C221P	T	58.5/138.3
C2608	4030017330	S.CER ECJ0EF1C104Z	B	87.5/128.6
C2610	4510009250	S.ELE EEEFK1C471P	T	6.2/65.3
C2612	4030017330	S.CER ECJ0EF1C104Z	B	33.9/123.9
C2613	4510009250	S.ELE EEEFK1C471P	T	31.7/131.5
C2616	4030017780	S.CER ECJ0EB1E472K	B	31.6/134.3
C2617	4030017780	S.CER ECJ0EB1E472K	T	33.5/126
C2618	4030017430	S.CER ECJ0EC1H101J	B	31.6/133.4
C2619	4030017780	S.CER ECJ0EB1E472K	T	67.7/112.6
C2620	4510008630	S.ELE 16 CE 47 FE	B	82.9/119.1
C2621	4510008500	S.ELE EEE1CA101WP	T	49.2/138.3
C2622	4510008500	S.ELE EEE1CA101WP	T	60.1/130.4
C2624	4030017330	S.CER ECJ0EF1C104Z	B	38.4/124.5
CP1601	6910009670	S.CHE HK3-S-T	T	11.7/54.7
J1	6510007020	CON TMP-J01X-V6		
J101	6510007020	CON TMP-J01X-V6		
J401	6510007020	CON TMP-J01X-V6		
J801	6510007020	CON TMP-J01X-V6		
J2002	6510019971	S.CON 52808-1071	T	39/12.6
J2003	6510024861	S.CON 5406721-2	T	18.7/137.8
J2004	6510023511	S.CON 28FLT-SM2-TB(LF)(SN) 2	T	82.4/4.9
J2005	6510023511	S.CON 28FLT-SM2-TB(LF)(SN) 2	T	66/4.9
J2231	6510018961	S.CON B2B-PH-SM4-TF(LF)(SN)	T	51.6/129.5
J2251	6510022881	S.CON AXK5S30347YG	T	12.3/96.6
J2252	6510024820	S.CON AXK5S60340P 2	T	72.4/101.1
J2401	6510025770	S.CON 03-935H0-72BKA	B	57.7/136.6
J2402	6510025770	S.CON 03-935H0-72BKA	B	47/136.6
J2403	6510019371	S.CON B3B-ZR-SM4-TF(LF)(SN)	T	94.8/1.8
J2405	6510024880	S.CON 52689-3087	T	90.3/93.8
J2406	6510024880	S.CON 52689-3087	T	90.3/70.9
J2407	6510025770	S.CON 03-935H0-72BKA	B	68.4/136.6
J2601	6510014961	S.CON B2B-ZR-SM4-TF(LF)(SN)	T	42.6/128.8
J2602	6510025770	S.CON 03-935H0-72BKA	B	36.3/136.6
W1	9029701008	WIR 72/98/020/X98/X98		
W601	9029701008	WIR 72/98/020/X98/X98		
EP104	6910012350	S.BEA MMZ1608Y 102BT	T	61.2/28.2
EP511	6910012350	S.BEA MMZ1608Y 102BT	T	44.1/26.5
EP1951	6910014730	S.BEA MPZ2012S331A-T	B	61.3/116.7
EP1952	6910014730	S.BEA MPZ2012S331A-T	B	26.8/113.3
EP1953	6910014730	S.BEA MPZ2012S331A-T	B	9.9/104.5
EP1954	6910014730	S.BEA MPZ2012S331A-T	B	50.3/107.3
EP2001	6910012350	S.BEA MMZ1608Y 102BT	B	74.2/5.3
EP2002	6910012350	S.BEA MMZ1608Y 102BT	B	34.7/12.6
EP2003	6910012350	S.BEA MMZ1608Y 102BT	B	33.5/13.8
EP2004	6910012350	S.BEA MMZ1608Y 102BT	B	39.5/15.9
EP2006	6910014730	S.BEA MPZ2012S331A-T	B	42.2/13.3
EP2007	6910012350	S.BEA MMZ1608Y 102BT	B	45.2/11
EP2008	6910012350	S.BEA MMZ1608Y 102BT	B	45.1/14.8
EP2231	6910012350	S.BEA MMZ1608Y 102BT	T	59.8/125.7
EP2251	6910012350	S.BEA MMZ1608Y 102BT	T	4.5/95.5
EP2252	6910012350	S.BEA MMZ1608Y 102BT	T	7.5/95.8
EP2253	6910012350	S.BEA MMZ1608Y 102BT	T	66.1/109.3
EP2254	6910012350	S.BEA MMZ1608Y 102BT	T	65.7/108.1
EP2255	6910012350	S.BEA MMZ1608Y 102BT	T	17.8/101.5
EP2256	6910012350	S.BEA MMZ1608Y 102BT	T	65.1/106
EP2257	6910012350	S.BEA MMZ1608Y 102BT	T	65.1/104.8
EP2258	6910012350	S.BEA MMZ1608Y 102BT	B	77.9/93.4
EP2259	6910012350	S.BEA MMZ1608Y 102BT	B	68.1/10

[MAIN UNIT]

REF NO.	PARTS NO.	DESCRIPTION	M.	H/V LOCATION
EP2271	6910012350	S.BEA MMZ1608Y 102BT	T	74.6/91.1
EP2402	6910012350	S.BEA MMZ1608Y 102BT	B	51.1/129.6
EP2403	6910012350	S.BEA MMZ1608Y 102BT	B	48.4/129.6
EP2404	6910012350	S.BEA MMZ1608Y 102BT	B	68.5/129.3
EP2405	6910012350	S.BEA MMZ1608Y 102BT	B	62.1/134.9
EP2408	6910012350	S.BEA MMZ1608Y 102BT	B	91.3/102.7
EP2409	6910012350	S.BEA MMZ1608Y 102BT	T	85.3/101.2
EP2410	6910012350	S.BEA MMZ1608Y 102BT	T	84.7/98.3
EP2411	6910012350	S.BEA MMZ1608Y 102BT	T	85.2/79.2
EP2412	6910012350	S.BEA MMZ1608Y 102BT	T	82.5/78.4
EP2413	6910012350	S.BEA MMZ1608Y 102BT	B	72.4/129.3
EP2414	6910012350	S.BEA MMZ1608Y 102BT	B	89.3/91
EP2415	6910012350	S.BEA MMZ1608Y 102BT	T	84.9/100
EP2416	6910012350	S.BEA MMZ1608Y 102BT	T	80/77.6
EP2417	6910012350	S.BEA MMZ1608Y 102BT	B	87.2/78.8
EP2602	6910014730	S.BEA MPZ2012S331A-T	T	35.9/125.6
EP2604	6910014730	S.BEA MPZ2012S331A-T	B	31.6/135.7
EP2605	6910014730	S.BEA MPZ2012S331A-T	T	42.9/135.4
EP2606	6910014730	S.BEA MPZ2012S331A-T	T	41.3/133.7
MP201	8510017210	PLA 2427 B-SHIELD PLATE Y801	B	23.1/59.8
W101	8970024640	CBL 1.5D175MM C24/C31		
W401	8970024650	CBL 1.5D 200MM (SX2427 A5-6G1)		

[PA UNIT]

REF NO.	PARTS NO.	DESCRIPTION	M.	H/V LOCATION
IC471	1110005630	S.IC UPC3215TB-E3-A	B	67.6/96.4
IC701	1180002010	S.REG BA08FP-E2	B	126.3/41.9
IC960	1110002700	S.IC NJM2904M-TE1-#FMZB	B	41/132.1
IC981	1130012720	S.IC CD74HC4094PWR	T	26.2/5.9
Q101	1560001091	S.FET 2SK2854(T2LICOM,F)	T	149.2/28.5
Q102	1560001241	S.FET RD01MUS1-T113	T	146/40.1
Q301	1560001391	FET RD70HHF1-101		
Q302	1560001391	FET RD70HHF1-101		
Q401	1560001401	FET RD60HUF1-101		
Q402	1590000680	S.TRA DTC114EUA T106	B	87.7/132.8
Q403	1590000680	S.TRA DTC114EUA T106	B	90/130.3
Q451	1580000691	S.FET 3SK291(TE85R,F)	B	76.7/108.3
Q452	1590003940	S.TRA RN1105(TE85L,F)	B	67.5/115.8
Q453	1590003940	S.TRA RN1105(TE85L,F)	B	75.1/119.8
Q501	1560001591	FET RD70HVF1C-121		
Q502	1590000680	S.TRA DTC114EUA T106	T	87.7/107.5
Q503	1590000680	S.TRA DTC114EUA T106	T	87.7/110
Q551	1580000691	S.FET 3SK291(TE85R,F)	T	68.4/108.9
Q552	1590003940	S.TRA RN1105(TE85L,F)	T	63/110.1
Q700	1590003940	S.TRA RN1105(TE85L,F)	B	126.4/25
Q741	1590003940	S.TRA RN1105(TE85L,F)	B	79.4/9
Q742	1520000460	S.TRA 2SB1132 T100 R	B	83.6/8.2
Q980	1590003940	S.TRA RN1105(TE85L,F)	T	51.3/84.6
Q981	1590003940	S.TRA RN1105(TE85L,F)	T	51.5/13.8
Q982	1590003940	S.TRA RN1105(TE85L,F)	T	53.8/97.3
Q983	1590003940	S.TRA RN1105(TE85L,F)	T	51.2/56.9
Q984	1590003940	S.TRA RN1105(TE85L,F)	T	51.6/97.2
Q985	1590003940	S.TRA RN1105(TE85L,F)	T	51.3/27.9
Q986	1590003940	S.TRA RN1105(TE85L,F)	T	51.3/71.4
Q987	1590003940	S.TRA RN1105(TE85L,F)	T	52.5/41.6
Q988	1590003930	S.TRA UMD22N TR	T	58.2/90.2
D101	1750000301	S.DIO 1SS302(TE85R,F)	T	152.4/22.7
D102	1750000301	S.DIO 1SS302(TE85R,F)	T	152.4/19.8
D151	1750000581	S.DIO 1SV307(TPH3,F)	T	59.5/56.4
D152	1790001250	S.DIO MA2S111-(TX)	T	56.3/58.5
D301	1160000060	S.DIO DAN202U T106	T	105.1/80.8
D302	1160000060	S.DIO DAN202U T106	T	74.9/87.3
D401	1790001240	S.DIO MA2S728-(TX)	B	128/133.6
D402	1790001240	S.DIO MA2S728-(TX)	B	127.5/139.5
D403	1790001240	S.DIO MA2S728-(TX)	B	123.4/140.5
D404	1790001240	S.DIO MA2S728-(TX)	B	125.6/132.8
D406	1710001061	DIO L407CDB		
D407	1710001061	DIO L407CDB		
D408	1750000511	S.DIO UX9401F-STD/TR	B	97.7/136.4
D409	1750000511	S.DIO UX9401F-STD/TR	B	103.5/133
D410	1750000511	S.DIO UX9401F-STD/TR	B	104.7/130
D411	1790001250	S.DIO MA2S111-(TX)	B	94.2/129.2
D412	1160000070	S.DIO DAN202K T146	B	91.6/127
D451	1750000581	S.DIO 1SV307(TPH3,F)	B	85.5/116.3
D452	1750000581	S.DIO 1SV307(TPH3,F)	B	82.4/116
D453	1720000701	S.VAR 1SV305(TPL3,F)	T	75.5/117.3
D454	1720000701	S.VAR 1SV305(TPL3,F)	T	77.8/116.6
D455	1720000701	S.VAR 1SV305(TPL3,F)	B	75.6/99.1
D456	1720000701	S.VAR 1SV305(TPL3,F)	B	67.3/104.1
D461	1750000581	S.DIO 1SV307(TPH3,F)	B	65/93.5
D462	1750000581	S.DIO 1SV307(TPH3,F)	T	65.6/94.7
D501	1790000970	S.DIO MA729(TX)	B	113.7/123.4
D502	1790000970	S.DIO MA729(TX)	B	116.3/122.8
D503	1790000970	S.DIO MA729(TX)	B	114.5/129.4
D504	1790000970	S.DIO MA729(TX)	B	111/129.4
D506	1710001061	DIO L407CDB		
D507	1750000511	S.DIO UX9401F-STD/TR	B	92.1/117.4
D508	1750000511	S.DIO UX9401F-STD/TR	T	86.9/114.4
D509	1750000511	S.DIO UX9401F-STD/TR	T	81.9/120.3
D510	1710001061	DIO L407CDB		
D511	1750000581	S.DIO 1SV307(TPH3,F)	B	95.3/112.2
D551	1750000581	S.DIO 1SV307(TPH3,F)	T	74/116.7
D552	1750000581	S.DIO 1SV307(TPH3,F)	T	72.2/116.7
D553	1750000610	S.VAR MA2SV0500L 0	T	67.2/118.5
D554	1750000610	S.VAR MA2SV0500L 0	T	69.6/117.8
D555	1750000581	S.DIO 1SV307(TPH3,F)	T	66.9/116.7
D556	1720000590	S.VAR MA357(TX) 0	T	71.6/113.3
D557	1750000581	S.DIO 1SV307(TPH3,F)	T	68.1/104.9
D558	1720000590	S.VAR MA357(TX) 0	T	72.2/104.3
D559	1750000610	S.VAR MA2SV0500L 0	T	68.9/102.7
D560	1750000610	S.VAR MA2SV0500L 0	T	71.7/101.3
D701	1790000700	DIO DSA3A1		
D702	1790000700	DIO DSA3A1		
D703	1160000070	S.DIO DAN202K T146	B	126.5/21.5
D704	1790001240	S.DIO MA2S728-(TX)	B	87.9/113.9
D705	1160000070	S.DIO DAN202K T146	B	137.5/14.2
D706	1790001240	S.DIO MA2S728-(TX)	B	86/113
D801	1750000301	S.DIO 1SS302(TE85R,F)	B	42.7/41.8
D820	1750000301	S.DIO 1SS302(TE85R,F)	B	54.3/94.5
D840	1750000301	S.DIO 1SS302(TE85R,F)	B	43.3/99.8
D860	1750000301	S.DIO 1SS302(TE85R,F)	B	43/86
D880	1750000301	S.DIO 1SS302(TE85R,F)	B	43.3/71.6
D900	1750000301	S.DIO 1SS302(TE85R,F)	B	43.7/56.9
D920	1750000301	S.DIO 1SS302(TE85R,F)	B	42.9/28
D940	1750000301	S.DIO 1SS302(TE85R,F)	B	41.1/14.2
D961	1790000491	S.DIO HSM88ASTR-E	B	28.1/130.2
D962	1790000491	S.DIO HSM88ASTR-E	B	28.1/133.7
D964	1750000511	S.DIO UX9401F-STD/TR	B	40.1/43.9
D965	1750000511	S.DIO UX9401F-STD/TR	B	42.8/48

M.=Mounted side (T: Mounted on the Top side, B: Mounted on the Bottom side)
S.=Surface mount

[PA UNIT]

REF NO.	PARTS NO.	DESCRIPTION	M.	H/V LOCATION
L101	6200005051	S.COI NLV25T-330J	T	151.3/33.6
L102	6200008570	S.COI LQW2BHN6N8D03L	T	152.3/37.3
L103	6180000990	COI LAL 04NA 101K		
L104	6180000990	COI LAL 04NA 101K		
L105	6200003950	S.COI HF50ACC 322513-T	B	135.7/34.1
L107	6200002631	S.COI NLV25-FR10J	T	141/47.9
L108	6200003031	S.COI NLV32T-FR47J	B	138/41.7
L151	6200003941	S.COI NLV25T-5R6J	B	64.1/41
L152	6200005521	S.COI NLV25T-470J	B	64.8/38
L201	6140004580	S.COI LR-515	T	150.4/52.5
L203	6200010040	S.COI AS100340-10N	T	113.8/79.5
L204	6200010040	S.COI AS100340-10N	T	123.5/69.7
L301	6140003410	COI LR-383		
L302	2040000490	COI EXC-ELDR25C		
L303	6140003590	COI LR-400 (TR10X5X5 6H3)		
L304	6140004570	COI LR-507		
L305	6140004560	COI LR-506		
L404	6200010060	S.COI AS080647-56N	T	141/108.9
L407	6200010170	S.COI AS080447-33N	T	146.6/110.7
L408	2040000490	COI EXC-ELDR25C		
L409	2040000490	COI EXC-ELDR25C		
L410	6200010040	S.COI AS100340-10N	T	126.5/137.8
L411	6200010420	S.COI FHW1210HC 1R0JGT <JJE>	T	118.3/136.7
L412	6200010160	S.COI AS080440-22N	T	104.4/134.4
L413	6200010150	S.COI AS080340-15N	T	88.2/139.5
L414	6200010150	S.COI AS080340-15N	T	81/133.5
L415	6200012960	S.COI 0.45-1.4-4TLL 12.1N <COMO>	T	99.2/134
L416	6200013000	S.COI 0.25-1.9-13TL 135N <COMO>	T	93.8/132.1
L417	6200007790	S.COI LQW2BHN15J03L	B	98.3/131.1
L441	6200010040	S.COI AS100340-10N	T	133.4/137.8
L451	6200005621	S.COI ELJRE 4N7ZFA	B	81.5/120.1
L452	6200012660	S.COI 0.30-1.0-4TR 9.1N <COMO>	T	76.7/119.4
L453	6200007230	S.COI LQW2BHN15N03L	B	74/104
L454	6200007230	S.COI LQW2BHN15N03L	B	69.9/102.3
L501	6200010780	S.COI C2520C-1R0G-A	T	117.1/86.6
L502	6200010060	S.COI AS080647-56N	T	118.1/125
L504	6200010780	S.COI C2520C-1R0G-A	T	105.7/123.4
L505	6200010070	S.COI AS080747-68N	T	90.2/118.5
L506	6200010170	S.COI AS080447-33N	T	91.9/124.3
L507	6200012910	S.COI 0.35-1.6-8TL 45.5N <COMO>	T	84.7/118
L508	6200010050	S.COI AS080547-47N	T	81.8/127.7
L509	6200010780	S.COI C2520C-1R0G-A	T	93.2/113.1
L510	6200010050	S.COI AS080547-47N	T	75.5/127.5
L531	6110003980	COI LA-604		
L541	6200010070	S.COI AS080747-68N	T	128.5/129.8
L551	6200007700	S.COI LQW2BHN22N03L	T	76.1/120.8
L552	6200007720	S.COI LQW2BHN33N03L	T	70.8/121.2
L553	6200008090	S.COI LQW2BHN68N03L	T	65.1/121.6
L554	6200003640	S.COI MLF1608E 100K-T	T	64.9/114.8
L555	6200003711	S.COI NLV25T-2R7J	T	65.2/105.4
L556	6200003640	S.COI MLF1608E 100K-T	B	64.9/109.6
L557	6200007760	S.COI LQW2BHN82N03L	T	66.8/100.5
L558	6200007710	S.COI LQW2BHN27N03L	T	69.9/98.3
L560	6200002611	S.COI NLV25T-FR47J	T	62.9/97.7
L601	6200010040	S.COI AS100340-10N	T	69.2/127.5
L602	6200010160	S.COI AS080440-22N	T	65.7/132.8
L603	6200010150	S.COI AS080340-15N	T	60.8/133.5
L705	6200003550	S.COI MLF1608A 4R7K-T	B	68.2/10.3
L706	6200011300	S.COI EXCML16A270U	T	91/6.9
L707	6200011300	S.COI EXCML16A270U	T	91/5.6
L801	6200011410	S.COI C2520C-82NG-A	T	55.8/55.5
L802	6200010650	S.COI C2520C-1R12G-A (0.12U)	T	58.5/52.1
L803	6200007420	S.COI ELJFC 101K-F	B	50.4/39.8
L820	6200006430	S.COI ELJFC 180K-F	B	52.8/97.3
L821	6140002020	COI LR-229 (T50-10)		
L822	6140003540	COI LR-396		
L823	6200006430	S.COI ELJFC 180K-F	B	2.7/106.8
L840	6200007420	S.COI ELJFC 101K-F	B	49.2/98.5
L841	6140001820	COI LR-218 (T50-10)		
L842	6140001800	COI LR-216 (T50-2)		
L843	6140001800	COI LR-216 (T50-2)		
L844	6200007420	S.COI ELJFC 101K-F	B	2.6/90.7
L860	6200004440	S.COI ELJFC 4R7M-F	B	50.3/83.8
L861	6110003550	COI LA-547 (LA-214A)		
L862	6110003570	COI LA-550		
L863	6110003540	COI LA-548 (LA-215A)		
L864	6200004440	S.COI ELJFC 4R7M-F	B	2.8/74.5
L880	6200007420	S.COI ELJFC 101K-F	B	50.3/69.1
L881	6140002570	COI LR-294 (T50-2)		
L882	6140002580	COI LR-295 (T50-2)		
L883	6200007420	S.COI ELJFC 101K-F	B	2.6/58.4
L900	6200008600	S.COI ELJFC 560K-F	B	50/54.6
L901	6140002560	COI LR-293 (T50-10)		
L902	6140002560	COI LR-293 (T50-10)		
L903	6140002560	COI LR-293 (T50-10)		
L904	6200008600	S.COI ELJFC 560K-F	B	2.6/42.3
L920	6200007420	S.COI ELJFC 101K-F	B	50.4/25.4
L921	6140001780	COI LR-214 (T50-2)		
L922	6140001780	COI LR-214 (T50-2)		
L923	6200007420	S.COI ELJFC 101K-F	B	2.6/26.1
L940	6200007390	S.COI ELJFC 120K-F	B	47.3/9.9
L941	6140003450	COI LR-387 (T50-10)		
L942	6140003460	COI LR-388 (T50-10)		
L943	6200007420	S.COI ELJFC 101K-F	B	41.1/11.1
L944	6200007390	S.COI ELJFC 120K-F	B	9/10.5
L960	6200007420	S.COI ELJFC 101K-F	B	45.3/130.6
L961	6140003490	COI LR-391 (TR10X5X5 3A6)		
L980	6200007420	S.COI ELJFC 101K-F	B	30.7/8
L981	6200007420	S.COI ELJFC 101K-F	T	51.7/9

[PA UNIT]

REF NO.	PARTS NO.	DESCRIPTION	M.	H/V LOCATION
L982	6200007420	S.COI ELJFC 101K-F	T	48.3/2.3
R101	7030003370	S.RES ERJ3GEYJ 271 V (270)	B	150.9/21
R102	7030003230	S.RES ERJ3GEYJ 180 V (18)	B	150.9/22.5
R103	7030003370	S.RES ERJ3GEYJ 271 V (270)	B	151.9/25.2
R104	7030003300	S.RES ERJ3GEYJ 680 V (68)	B	150.8/27.7
R105	7030003420	S.RES ERJ3GEYJ 681 V (680)	T	152.7/29.8
R106	7030003480	S.RES ERJ3GEYJ 222 V (2.2K)	B	147.8/29.7
R107	7030003530	S.RES ERJ3GEYJ 562 V (5.6K)	B	147.8/28.3
R108	7030003400	S.RES ERJ3GEYJ 471 V (470)	T	151.4/31.7
R109	7030008190	S.RES ERJ12YJ330U (33)	B	145.5/32.7
R110	7030000230	S.RES MCR10EZJH 56 (560)	T	149.4/39.8
R111	7030003410	S.RES ERJ3GEYJ 561 V (560)	B	143.8/42.1
R112	7030003510	S.RES ERJ3GEYJ 392 V (3.9K)	B	146.1/37.5
R113	7030003540	S.RES ERJ3GEYJ 682 V (6.8K)	B	146.1/35.7
R116	7030000340	S.RES MCR10EZJH 470 (471)	B	141.3/40.8
R117	7030003860	S.RES ERJ3GE JPW V	T	146.7/47.7
R151	7030003380	S.RES ERJ3GEYJ 331 V (330)	B	61.6/87.8
R152	7030003440	S.RES ERJ3GEYJ 102 V (1K)	B	61.7/60.1
R153	7030003520	S.RES ERJ3GEYJ 472 V (4.7K)	T	59.2/57.9
R201	7030003320	S.RES ERJ3GEYJ 101 V (100)	B	123/49.9
R202	7030003520	S.RES ERJ3GEYJ 472 V (4.7K)	B	136/49.8
R204	7030003440	S.RES ERJ3GEYJ 102 V (1K)	B	138/52.8
R205	7030010420	S.RES ERJ1TYJ 560U (56)	B	145/51.5
R301	7030009300	S.RES ERJ1WYOR00U	B	92.2/84.4
R302	7030010520	S.RES ERJ1TYJ 101U (100)	T	89.4/86.1
R303	7030009300	S.RES ERJ1WYOR00U	B	85.4/84.4
R304	7030003320	S.RES ERJ3GEYJ 101 V (100)	T	107.1/79.8
R305	7030010410	S.RES ERJ1TYJ 220U (22)	T	100.2/84.1
R306	7030003320	S.RES ERJ3GEYJ 101 V (100)	B	71.2/83.3
R307	7030010410	S.RES ERJ1TYJ 220U (22)	T	77.5/84.1
R308	7030003480	S.RES ERJ3GEYJ 222 V (2.2K)	B	99/84.9
R309	7030003480	S.RES ERJ3GEYJ 222 V (2.2K)	B	78.7/84.9
R310	7030007630	S.RES MCR100JZH 0.68 (R68)	B	100.1/82.2
R311	7030007630	S.RES MCR100JZH 0.68 (R68)	B	78.3/82.1
R312	7030011250	S.RES ERJ1TY 390U (39)	T	100.9/77.7
R313	7030010540	S.RES ERJ1TYJ 330U (33)	T	97.2/77.7
R314	7030010540	S.RES ERJ1TYJ 330U (33)	T	81.6/77.7
R315	7030011250	S.RES ERJ1TY 390U (39)	T	77.9/77.7
R317	7030010950	S.RES ERJ1TYJ 100U (10)	B	104/20.6
R318	7030010950	S.RES ERJ1TYJ 100U (10)	B	99.6/20.6
R319	7030010660	S.RES ERJ1TYJ 6R8U (6.8)	B	89.4/54.5
R402	7030003320	S.RES ERJ3GEYJ 101 V (100)	B	151.7/73.1
R403	7030003520	S.RES ERJ3GEYJ 472 V (4.7K)	T	151.8/71.2
R404	7030000260	S.RES MCR10EZJH 100 (101)	T	149.4/76
R405	7030003540	S.RES ERJ3GEYJ 682 V (6.8K)	B	126.7/137.5
R406	7030003860	S.RES ERJ3GE JPW V	B	128.4/136.1
R407	7030003440	S.RES ERJ3GEYJ 102 V (1K)	B	129.7/133.6
R408	7030003860	S.RES ERJ3GE JPW V	B	124.1/137.6
R409	7030003440	S.RES ERJ3GEYJ 102 V (1K)	B	127/130.4
R410	7030003440	S.RES ERJ3GEYJ 102 V (1K)	B	131.6/133
R411	7030003540	S.RES ERJ3GEYJ 682 V (6.8K)	B	125.1/135.5
R412	7030003500	S.RES ERJ3GEYJ 332 V (3.3K)	B	131.1/129.7
R413	7030007160	S.RES ERJ12YJ3R3U (3.3)	B	123.5/125.1
R415	7030008350	S.RES ERJ12YJ390U	B	86.7/136.4
R416	7030000140	S.RES MCR10EZJH 10 (100)	B	93.8/130.7
R417	7030000140	S.RES MCR10EZJH 10 (100)	B	95.5/132.5
R418	7030000010	S.RES MCR10EZJH JPW (000)	B	99.3/133.9
R451	7030003470	S.RES ERJ3GEYJ 182 V (1.8K)	B	81.5/121.7
R452	7030004040	S.RES ERJ3GEYJ 4R7 V (4.7)	B	85.5/119.3
R453	7030003260	S.RES ERJ3GEYJ 330 V (33)	B	81.6/118.4
R454	7030003860	S.RES ERJ3GE JPW V	B	77.3/116
R455	7030003640	S.RES ERJ3GEYJ 473 V (47K)	B	73.2/117.5
R456	7030003700	S.RES ERJ3GEYJ 154 V (150K)	B	72/114.4
R457	7030003750	S.RES ERJ3GEYJ 394 V (390K)	B	71.2/111.9
R458	7030003710	S.RES ERJ3GEYJ 184 V (180K)	B	73.8/112.4
R459	7030003740	S.RES ERJ3GEYJ 334 V (330K)	B	69.6/111.3
R460	7030003740	S.RES ERJ3GEYJ 334 V (330K)	B	76.6/112.1
R461	7030003270	S.RES ERJ3GEYJ 390 V (39)	B	77.7/103.3
R462	7030003680	S.RES ERJ3GEYJ 104 V (100K)	B	72.9/99.6
R463	7030003520	S.RES ERJ3GEYJ 472 V (4.7K)	B	74.4/102.4
R464	7030003210	S.RES ERJ3GEYJ 120 V (12)	B	74.1/105.7
R465	7030003680	S.RES ERJ3GEYJ 104 V (100K)	B	66.5/101.7
R466	7030003860	S.RES ERJ3GE JPW V	B	62.1/100.2
R467	7030003640	S.RES ERJ3GEYJ 473 V (47K)	B	75.1/117.2
R468	7030008240	S.RES ERJ12YOR00U	B	89.1/121.9
R470	7030003320	S.RES ERJ3GEYJ 101 V (100)	B	67.7/98.8
R471	7030003270	S.RES ERJ3GEYJ 390 V (39)	B	69.6/98.3
R472	7030003340	S.RES ERJ3GEYJ 151 V (150)	B	69.6/99.5
R473	7030003340	S.RES ERJ3GEYJ 151 V (150)	B	69.6/100.7
R474	7030003340	S.RES ERJ3GEYJ 151 V (150)	B	63.5/96.9
R475	7030003340	S.RES ERJ3GEYJ 151 V (150)	B	64.9/96.9
R476	7030003270	S.RES ERJ3GEYJ 390 V (39)	B	64.8/95.1
R477	7030003360	S.RES ERJ3GEYJ 221 V (220)	B	61.8/97.6
R502	7030003320	S.RES ERJ3GEYJ 101 V (100)	T	112.1/87.9
R503	7030003520	S.RES ERJ3GEYJ 472 V (4.7K)	T	112.6/86
R504	7030000260	S.RES MCR10EZJH 100 (101)	T	114.2/86.2
R505	7030003540	S.RES ERJ3GEYJ 682 V (6.8K)	B	119.9/124.8
R507	7030003440	S.RES ERJ3GEYJ 102 V (1K)	B	110.

[PA UNIT]

REF NO.	PARTS NO.	DESCRIPTION	M.	H/V LOCATION
R519	7030000010	S.RES MCR10EZJH JPW (000)	B	111.1/119.1
R551	7030003470	S.RES ERJ3GEYJ 182 V (1.8K)	T	78.2/117.8
R552	7030004040	S.RES ERJ3GEYJ 4R7 V (4.7)	T	76.7/119.1
R553	7030003260	S.RES ERJ3GEYJ 330 V (33)	T	73/118.9
R554	7030003680	S.RES ERJ3GEYJ 104 V (100K)	T	66.8/120.4
R555	7030003440	S.RES ERJ3GEYJ 102 V (1K)	T	68.1/114.7
R556	7030003680	S.RES ERJ3GEYJ 104 V (100K)	T	69.9/116.6
R557	7030003740	S.RES ERJ3GEYJ 334 V (330K)	T	65.7/112.9
R558	7030003710	S.RES ERJ3GEYJ 184 V (180K)	T	70.5/111.2
R559	7030003720	S.RES ERJ3GEYJ 224 V (220K)	T	65.7/111.7
R560	7030003720	S.RES ERJ3GEYJ 224 V (220K)	T	65.6/110.5
R561	7030003740	S.RES ERJ3GEYJ 334 V (330K)	T	68.3/112.4
R562	7030003270	S.RES ERJ3GEYJ 390 V (39)	T	70.1/106.6
R563	7030003420	S.RES ERJ3GEYJ 681 V (680)	T	65.4/107.3
R564	7030003210	S.RES ERJ3GEYJ 120 V (12)	T	63.5/103
R565	7030003440	S.RES ERJ3GEYJ 102 V (1K)	B	65.6/106.3
R567	7030003680	S.RES ERJ3GEYJ 104 V (100K)	T	70.1/104
R568	7030003680	S.RES ERJ3GEYJ 104 V (100K)	T	69.7/100.7
R570	7030003380	S.RES ERJ3GEYJ 331 V (330)	T	62.8/100.3
R575	7030003520	S.RES ERJ3GEYJ 472 V (4.7K)	T	68.4/100.7
R576	7030003540	S.RES ERJ3GEYJ 682 V (6.8K)	T	71.8/100
R577	7030003520	S.RES ERJ3GEYJ 472 V (4.7K)	T	68/120.4
R578	7030003540	S.RES ERJ3GEYJ 682 V (6.8K)	T	69.9/119
R701	7030003500	S.RES ERJ3GEYJ 332 V (3.3K)	B	82.2/16.9
R702	7030003500	S.RES ERJ3GEYJ 332 V (3.3K)	B	83/14.5
R703	7030003500	S.RES ERJ3GEYJ 332 V (3.3K)	B	80.6/16.9
R704	7030003500	S.RES ERJ3GEYJ 332 V (3.3K)	B	79.7/14.5
R705	7030009300	S.RES ERJ1WYOR00U	B	134.6/23.8
R721	7030011240	S.RES LRF3W-LF-01-R020F	B	83/22.3
R722	7030011240	S.RES LRF3W-LF-01-R020F	B	83/29.6
R723	7030004040	S.RES ERJ3GEYJ 4R7 V (4.7)	B	140.5/14.7
R733	7030009591	S.RES ERA3YED 472V (4.7K)	B	138.6/10.4
R734	7510001470	S.THE NTCG20 4AG 473JT	T	111.9/58.2
R735	7030009591	S.RES ERA3YED 472V (4.7K)	B	140.2/12.5
R736	7510001470	S.THE NTCG20 4AG 473JT	T	153.3/77.1
R742	7030003640	S.RES ERJ3GEYJ 473 V (47K)	B	83.4/11.5
R743	7030003440	S.RES ERJ3GEYJ 102 V (1K)	B	80.2/10.9
R744	7030003860	S.RES ERJ3GE JPW V	T	67.8/9.6
R749	7030003860	S.RES ERJ3GE JPW V	B	65/5.2
R750	7030003860	S.RES ERJ3GE JPW V	B	66.6/5.2
R773	7030003860	S.RES ERJ3GE JPW V	T	103.4/9.5
R960	7030003860	S.RES ERJ3GE JPW V	B	43.2/125.7
R961	7030003380	S.RES ERJ3GEYJ 331 V (330)	B	42/138.3
R962	7030003440	S.RES ERJ3GEYJ 102 V (1K)	B	37.4/137.8
R963	7030003440	S.RES ERJ3GEYJ 102 V (1K)	B	40.3/126.3
R964	7030003860	S.RES ERJ3GE JPW V	B	24.8/131.2
R965	7030003640	S.RES ERJ3GEYJ 473 V (47K)	B	32.6/130.5
R966	7030008190	S.RES ERJ12YJ330U (33)	B	11.1/129.6
R967	7030003640	S.RES ERJ3GEYJ 473 V (47K)	B	34.2/130.5
R968	7030003860	S.RES ERJ3GE JPW V	B	24.8/132.8
R969	7030003600	S.RES ERJ3GEYJ 223 V (22K)	B	32.6/133.6
R970	7030003680	S.RES ERJ3GEYJ 104 V (100K)	B	34.2/133.6
R971	7540000130	ABS 2P-50A-301		
R972	7030003620	S.RES ERJ3GEYJ 333 V (33K)	B	17.4/140.1
R973	7030003620	S.RES ERJ3GEYJ 333 V (33K)	B	18.9/138.5
R974	7030003620	S.RES ERJ3GEYJ 333 V (33K)	B	19.4/136.6
R994	7030003560	S.RES ERJ3GEYJ 103 V (10K)	B	22.4/6.8
R995	7030003560	S.RES ERJ3GEYJ 103 V (10K)	B	22.4/6.8
R996	7030003560	S.RES ERJ3GEYJ 103 V (10K)	B	21.6/5.4
R997	7030003560	S.RES ERJ3GEYJ 103 V (10K)	B	21.6/8.2
R998	7030003320	S.RES ERJ3GEYJ 101 V (100)	T	54.1/4.4
R999	7030003320	S.RES ERJ3GEYJ 101 V (100)	T	54.5/3.1
R1000	7030003320	S.RES ERJ3GEYJ 101 V (100)	T	51.2/3.5
R1001	7030003320	S.RES ERJ3GEYJ 101 V (100)	T	49.3/4.9
R1002	7030000280	S.RES MCR10EZJH 150 (151)	T	48/9.7
R1003	7030000290	S.RES MCR10EZJH 180 (181)	T	47.5/7.9
C101	4030011600	S.CER C1608 JB 1E 104K-T	T	151.9/25.1
C102	4030011600	S.CER C1608 JB 1E 104K-T	B	150.8/29.3
C103	4030011340	S.CER C1608 CH 1H 471J-T	T	152.7/27.2
C104	4030011600	S.CER C1608 JB 1E 104K-T	T	147.8/32.2
C105	4510004591	ELE 16 ME 470 HC		
C106	4030011600	S.CER C1608 JB 1E 104K-T	B	142.7/29.2
C107	4030011600	S.CER C1608 JB 1E 104K-T	T	151.6/39.7
C108	4030011600	S.CER C1608 JB 1E 104K-T	T	149.2/36.5
C109	4030007130	S.CER C1608 CH 1H 101J-T	B	146.6/42.1
C112	4030011600	S.CER C1608 JB 1E 104K-T	B	139.2/35.1
C113	4030011600	S.CER C1608 JB 1E 104K-T	T	144.6/44.4
C114	4030011600	S.CER C1608 JB 1E 104K-T	B	134.1/37
C116	4030007060	S.CER C1608 CH 1H 270J-T	T	144.6/45.8
C118	4030007130	S.CER C1608 CH 1H 101J-T	T	143.5/48.5
C119	4030007130	S.CER C1608 CH 1H 101J-T	T	144/50.4
C120	4030007020	S.CER C1608 CH 1H 120J-T	T	143.5/47.2
C122	4510008500	S.ELE EEE1CA101WP	T	121.5/11.2
C151	4030011600	S.CER C1608 JB 1E 104K-T	T	59.2/54.8
C152	4030006880	S.CER C1608 JB 1H 472K-T	B	61.6/36.2
C153	4030011600	S.CER C1608 JB 1E 104K-T	B	63.1/56
C154	4030006860	S.CER C1608 JB 1H 102K-T	B	63.1/54.7
C201	4030006860	S.CER C1608 JB 1H 102K-T	T	145.6/53
C202	4030006860	S.CER C1608 JB 1H 102K-T	T	143/53
C204	4030011600	S.CER C1608 JB 1E 104K-T	B	139.3/48.4
C205	4030006860	S.CER C1608 JB 1H 102K-T	B	123.3/48.6
C206	4030017810	S.CER C1608 CH 1H 102J-T	B	133.5/50.6
C207	4030017810	S.CER C1608 CH 1H 102J-T	B	139.3/49.7
C208	4030011600	S.CER C1608 JB 1E 104K-T	B	132/50.6
C209	4030007170	S.CER C1608 CH 1H 221J-T	B	139.3/51
C214	4030018940	S.CER GRM31A7U2J331JW31D	T	116.3/76.1
C215	4030018930	S.CER GRM31A7U2J221JW31D	T	122.2/73.9

[PA UNIT]

REF NO.	PARTS NO.	DESCRIPTION	M.	H/V LOCATION
C217	4030011600	S.CER C1608 JB 1E 104K-T	T	144.3/53
C218	4030018930	S.CER GRM31A7U2J221JW31D	T	101/88.5
C219	4030018930	S.CER GRM31A7U2J221JW31D	B	82.4/99.7
C251	4030011180	S.CER GRM31M2C2H220JV01L (GRM42-6 CH)	B	134.9/66
C252	4030011180	S.CER GRM31M2C2H220JV01L (GRM42-6 CH)	B	142.2/70.6
C253	4030011080	S.CER GRM31M2C2H6R0DV01L (GRM42-6 CH)	B	145.5/79
C254	4030011160	S.CER GRM31M2C2H150JV01L (GRM42-6 CH)	B	127.7/65.3
C261	4030012480	S.CER GRM31M2C2H121JV01L (GRM42-6 CH)	B	131.7/75.1
C262	4030018940	S.CER GRM31A7U2J331JW31D	B	126/80.1
C263	4030018770	S.CER C3216 CH 2J 102J-T	B	122.1/80.7
C266	4030018950	S.CER GRM31A7U2J681JW31D	B	119.7/80.2
C267	4030018930	S.CER GRM31A7U2J221JW31D	B	124/85.3
C301	4030001100	S.CER GRM216B11H102KA01D (GRM40 B)	B	91.7/100.6
C302	4030001020	S.CER GRM216C21H121JA01D (GRM40 CH)	B	93.8/100.6
C303	4030011600	S.CER C1608 JB 1E 104K-T	B	110.8/85.5
C304	4030017320	S.CER GRM21BB11H104KA01L (GRM40-034)	B	94.8/97.6
C305	4510004591	ELE 16 ME 470 HC		
C306	4030004720	S.CER C2012 JB 1H 102K-T	[EUR] B	83.6/39.8
	4030004720	S.CER C2012 JB 1H 102K-T	[FRA]	
	4030004720	S.CER C2012 JB 1H 102K-T	[ESP]	
	4030004720	S.CER C2012 JB 1H 102K-T	[USA]	
	4030004720	S.CER C2012 JB 1H 102K-T	[EXP]	
	4030004720	S.CER C2012 JB 1H 102K-T	[ITR]	
	4030004720	S.CER C2012 JB 1H 102K-T	[UK]	
	4030004720	S.CER C2012 JB 1H 102K-T	[KOR]	
	4030006860	S.CER C1608 JB 1H 102K-T	[AUS]	
	4030004720	S.CER C2012 JB 1H 102K-T	[CHN]	
	4030004720	S.CER C2012 JB 1H 102K-T	[EUR]	
C307	4030004720	S.CER C2012 JB 1H 102K-T	B	100.6/39.8
	4030004720	S.CER C2012 JB 1H 102K-T	[FRA]	
	4030004720	S.CER C2012 JB 1H 102K-T	[ESP]	
	4030004720	S.CER C2012 JB 1H 102K-T	[USA]	
	4030004720	S.CER C2012 JB 1H 102K-T	[EXP]	
	4030004720	S.CER C2012 JB 1H 102K-T	[ITR]	
	4030004720	S.CER C2012 JB 1H 102K-T	[UK]	
	4030004720	S.CER C2012 JB 1H 102K-T	[KOR]	
	4030006860	S.CER C1608 JB 1H 102K-T	[AUS]	
	4030004720	S.CER C2012 JB 1H 102K-T	[CHN]	
C308	4030004720	S.CER C2012 JB 1H 102K-T	B	91.9/10.9
	4030004720	S.CER C2012 JB 1H 102K-T	[FRA]	
	4030004720	S.CER C2012 JB 1H 102K-T	[ESP]	
	4030004720	S.CER C2012 JB 1H 102K-T	[USA]	
	4030004720	S.CER C2012 JB 1H 102K-T	[EXP]	
	4030004720	S.CER C2012 JB 1H 102K-T	[ITR]	
	4030004720	S.CER C2012 JB 1H 102K-T	[UK]	
	4030004720	S.CER C2012 JB 1H 102K-T	[KOR]	
	4030006860	S.CER C1608 JB 1H 102K-T	[AUS]	
	4030004720	S.CER C2012 JB 1H 102K-T	[CHN]	
C309	4030011600	S.CER C1608 JB 1E 104K-T	T	105.8/78.3
C311	4030018750	S.CER C3225 CH 2J 682K-T	B	92.7/78.5
C312	4030018750	S.CER C3225 CH 2J 682K-T	B	84.9/78.5
C313	4030011600	S.CER C1608 JB 1E 104K-T	T	76.8/87.8
C314	4030018750	S.CER C3225 CH 2J 682K-T	B	96.9/77.6
C315	4030018750	S.CER C3225 CH 2J 682K-T	B	80.6/77.6
C319	4030011730	S.CER GRM31M2C2H101JV01L (GRM42-6 CH)	B	110/48.8
C320	4030011730	S.CER GRM31M2C2H101JV01L (GRM42-6 CH)	B	71.1/48.9
C323	4030003810	S.MIC UC342H 1200J-T	B	91.4/46.4
C324	4320001050	S.MIC UC342H 3900J-T	T	94.4/40.2
C325	4320001070	S.MIC UC342H 3300J-T	B	94.4/40.7
C327	4030011790	S.CER GRM55RF52A684ZD01L (GRM44-1)	T	65.9/46.3
C331	4030011600	S.CER C1608 JB 1E 104K-T	T	108.3/78.3
C332	4030011600	S.CER C1608 JB 1E 104K-T	B	69.5/81.4
C333	4030018940	S.CER GRM31A7U2J331JW31D	B	88.4/101.8
C340	4030006860	S.CER C1608 JB 1H 102K-T	B	82.3/107.3
C341	4030006860	S.CER C1608 JB 1H 102K-T	B	92.4/107.4
C342	4030006860	S.CER C1608 JB 1H 102K-T	B	87.1/91.6
C350	4030004720	S.CER C2012 JB 1H 102K-T	[EUR] B	103.4/39.8
	4030004720	S.CER C2012 JB 1H 102K-T	[FRA]	
	4030004720	S.CER C2012 JB 1H 102K-T	[ESP]	
	4030004720	S.CER C2012 JB 1H 102K-T	[USA]	
	4030004720	S.CER C2012 JB 1H 102K-T	[EXP]	
	4030004720	S.CER C2012 JB 1H 102K-T	[ITR]	
	4030004720	S.CER C2012 JB 1H 102K-T	[UK]	
	4030004720	S.CER C2012 JB 1H 102K-T	[KOR]	
	4030004720	S.CER C2012 JB 1H 102K-T	[CHN]	
C351	4030004720	S.CER C2012 JB 1H 102K-T	B	106.1/39.8
	4030004720	S.CER C2012 JB 1H 102K-T	[FRA]	
	4030004720	S.CER C2012 JB 1H 102K-T	[ESP]	
	4030004720	S.CER C2012 JB 1H 102K-T	[USA]	
	4030004720	S.CER C2012 JB 1H 102K-T	[EXP]	
	4030004720	S.CER C2012 JB 1H 102K-T	[ITR]	
	4030004720	S.CER C2012 JB 1H 102K-T	[UK]	
	4030004720	S.CER C2012 JB 1H 102K-T	[KOR]	
	4030004720	S.CER C2012 JB 1H 102K-T	[CHN]	
C353	4030004720	S.CER C2012 JB 1H 102K-T	B	86.3/39.8
	4030004720	S.CER C2012 JB 1H 102K-T	[FRA]	
	4030004720	S.CER C2012 JB 1H 102K-T	[ESP]	

[PA UNIT]

REF NO.	PARTS NO.	DESCRIPTION	M.	H/V LOCATION
C353	4030004720	S.CER C2012 JB 1H 102K-T [ITR]		
	4030004720	S.CER C2012 JB 1H 102K-T [UK]		
	4030004720	S.CER C2012 JB 1H 102K-T [KOR]		
	4030004720	S.CER C2012 JB 1H 102K-T [CHN]		
C354	4030004720	S.CER C2012 JB 1H 102K-T [EUR]	B	89.1/39.8
	4030004720	S.CER C2012 JB 1H 102K-T [FRA]		
	4030004720	S.CER C2012 JB 1H 102K-T [ESP]		
	4030004720	S.CER C2012 JB 1H 102K-T [USA]		
C356	4030004720	S.CER C2012 JB 1H 102K-T [EXP]		
	4030004720	S.CER C2012 JB 1H 102K-T [ITR]		
	4030004720	S.CER C2012 JB 1H 102K-T [UK]		
	4030004720	S.CER C2012 JB 1H 102K-T [KOR]		
C357	4030004720	S.CER C2012 JB 1H 102K-T [CHN]	B	94.7/10.9
	4030004720	S.CER C2012 JB 1H 102K-T [EUR]		
	4030004720	S.CER C2012 JB 1H 102K-T [FRA]		
	4030004720	S.CER C2012 JB 1H 102K-T [ESP]		
C358	4030004720	S.CER C2012 JB 1H 102K-T [USA]		
	4030004720	S.CER C2012 JB 1H 102K-T [EXP]		
	4030004720	S.CER C2012 JB 1H 102K-T [ITR]		
	4030004720	S.CER C2012 JB 1H 102K-T [UK]		
C359	4030004720	S.CER C2012 JB 1H 102K-T [KOR]	B	94.9/107.4
	4030006860	S.CER C1608 JB 1H 102K-T [CHN]		
	4030006860	S.CER C1608 JB 1H 102K-T [EUR]		
	4030006860	S.CER C1608 JB 1H 102K-T [FRA]		
C360	4030006860	S.CER C1608 JB 1H 102K-T [ESP]		
	4030006860	S.CER C1608 JB 1H 102K-T [USA]		
	4030006860	S.CER C1608 JB 1H 102K-T [EXP]		
	4030006860	S.CER C1608 JB 1H 102K-T [ITR]		
C403	4030006860	S.CER C1608 JB 1H 102K-T [UK]	B	89.6/133.4
	4030006860	S.CER C1608 JB 1H 102K-T [KOR]	B	151.7/71.4
	4030006860	S.CER C1608 JB 1H 102K-T [CHN]		
	4030011740	S.CER GRM32N2C2H201JV01L (GRM42-2 CH)	T	145.3/105.7
C406	4030006860	S.CER C1608 JB 1H 102K-T	B	132.4/129.7
C408	4030018040	S.CER ERF22X 6C2H 180J D01L	B	134.2/93
C409	4030018040	S.CER ERF22X 6C2H 180J D01L	B	145.4/93
C410	4030018260	S.CER ERF22X 6C2H 150J D01L	B	145.4/96.4
C411	4030018260	S.CER ERF22X 6C2H 150J D01L	B	134.2/96.4
C412	4030018770	S.CER C3216 CH 2J 102J-T	T	136/111.5
C413	4030018770	S.CER C3216 CH 2J 102J-T	T	139.8/102.7
C415	4030018410	S.CER ERF22X 6C2H 2R0C D01L	T	143.1/139.4
C416	4030006880	S.CER C1608 JB 1H 472K-T	T	103.1/96.7
C417	4030018040	S.CER ERF22X 6C2H 180J D01L	T	139.2/136.2
C418	4030011120	S.CER GRM31M2C2H100JV01L (GRM42-6 CH)	B	134.1/134.2
C419	4030011020	S.CER GRM31M4C2H1R0CY21L (GRM42-6 CK)	B	132.6/138.2
C420	4030011080	S.CER GRM31M2C2H6R0DV01L (GRM42-6 CH)	B	129.2/139.5
C421	4030011020	S.CER GRM31M4C2H1R0CY21L (GRM42-6 CK)	B	120.6/136.8
C422	4030011120	S.CER GRM31M2C2H100JV01L (GRM42-6 CH)	B	121.7/141.1
C423	4030007090	S.CER C1608 CH 1H 470J-T	B	127.8/131.7
C424	4030011090	S.CER GRM31M2C2H7R0DV01L (GRM42-6 CH)	B	119/140.3
C425	4030011180	S.CER GRM31M2C2H220JV01L (GRM42-6 CH)	T	121.6/137.4
C426	4030006860	S.CER C1608 JB 1H 102K-T	B	106.7/133.9
C427	4030011020	S.CER GRM31M4C2H1R0CY21L (GRM42-6 CK) [EUR]	B	102.6/139.6
	4030011020	S.CER GRM31M4C2H1R0CY21L (GRM42-6 CK) [FRA]		
	4030011020	S.CER GRM31M4C2H1R0CY21L (GRM42-6 CK) [ESP]		
	4030011020	S.CER GRM31M4C2H1R0CY21L (GRM42-6 CK) [USA]		
	4030011020	S.CER GRM31M4C2H1R0CY21L (GRM42-6 CK) [EXP]		

[PA UNIT]

REF NO.	PARTS NO.	DESCRIPTION	M.	H/V LOCATION
C427	4030011020	S.CER GRM31M4C2H1R0CY21L (GRM42-6 CK) [ITR]		
	4030011040	S.CER GRM31M4C2H2R0CY21L (GRM42-6 CK) [UK]		
	4030011020	S.CER GRM31M4C2H1R0CY21L (GRM42-6 CK) [KOR]		
	4030011020	S.CER GRM31M4C2H1R0CY21L (GRM42-6 CK) [AUS]		
	4030011020	S.CER GRM31M4C2H1R0CY21L (GRM42-6 CK) [CHN]		
C428	4030011090	S.CER GRM31M2C2H7R0DV01L (GRM42-6 CH)	T	97/138.1
C429	4030017940	S.CER ERF22X 6C2H 680J D01L	T	92.3/136.9
C430	4030019410	S.CER GRM31A7U2J471JW31D	B	94.2/138
C431	4030011070	S.CER GRM31M2C2H5R0CY21L (GRM42-6 CH)	T	86.9/133.8
C432	4030004820	S.CER C2012 CH 1H 050C-T	B	99.2/139.3
C433	4030011090	S.CER GRM31M2C2H7R0DV01L (GRM42-6 CH)	T	76.1/132.2
C434	4030006860	S.CER C1608 JB 1H 102K-T	B	89.9/124.9
C435	4030006860	S.CER C1608 JB 1H 102K-T	B	97.2/127.7
C436	4030006860	S.CER C1608 JB 1H 102K-T	T	98.4/130.9
C438	4030006850	S.CER C1608 JB 1H 471K-T	B	90.8/134
C439	4030006860	S.CER C1608 JB 1H 102K-T	B	92.8/133.1
C440	4030004710	S.CER C2012 JB 1H 471K-T	B	103.5/135.5
C441	4030011090	S.CER GRM31M2C2H7R0DV01L (GRM42-6 CH)	T	137.6/140.4
C443	4030011020	S.CER GRM31M4C2H1R0CY21L (GRM42-6 CK)	B	122.1/131
C444	4030006860	S.CER C1608 JB 1H 102K-T	B	59.3/117.9
C452	4030007020	S.CER C1608 CH 1H 120J-T	B	87.3/119.3
C453	4030006860	S.CER C1608 JB 1H 102K-T	T	63.9/117.3
C456	4030009350	S.CER C1608 CH 1H 3R5B-T	B	78.2/118.4
C458	4030006860	S.CER C1608 JB 1H 102K-T	T	73.8/113.1
C461	4030011600	S.CER C1608 JB 1E 104K-T	B	68.8/113.3
C462	4030011600	S.CER C1608 JB 1E 104K-T	B	77.1/110.8
C463	4030006860	S.CER C1608 JB 1H 102K-T	B	79.1/109.6
C464	4030011600	S.CER C1608 JB 1E 104K-T	B	77.7/105.9
C465	4030011600	S.CER C1608 JB 1E 104K-T	B	67.7/108.9
C466	4030006860	S.CER C1608 JB 1H 102K-T	B	77.7/104.6
C467	4030006860	S.CER C1608 JB 1H 102K-T	B	67.7/107.6
C468	4030007020	S.CER C1608 CH 1H 120J-T	B	73.7/101.1
C470	4030011600	S.CER C1608 JB 1E 104K-T	B	77.7/101.7
C471	4030006860	S.CER C1608 JB 1H 102K-T	B	77.7/100.4
C472	4030009500	S.CER C1608 CH 1H 0R5B-T	B	69.7/105.2
C473	4030007040	S.CER C1608 CH 1H 180J-T	B	69.7/104
C474	4030009530	S.CER C1608 CH 1H 030B-T	B	67.7/101.7
C475	4030006860	S.CER C1608 JB 1H 102K-T	B	66.5/98.8
C476	4030006860	S.CER C1608 JB 1H 102K-T	B	68/111.3
C477	4030006860	S.CER C1608 JB 1H 102K-T	B	79.1/121.9
C478	4030006860	S.CER C1608 JB 1H 102K-T	B	57.7/120.5
C479	4030006860	S.CER C1608 JB 1H 102K-T	B	56.9/121.8
C480	4030007090	S.CER C1608 CH 1H 470J-T	B	63.4/100.8
C481	4030006860	S.CER C1608 JB 1H 102K-T	B	69.6/96.3
C482	4030006860	S.CER C1608 JB 1H 102K-T	B	67.9/94.5
C483	4030006860	S.CER C1608 JB 1H 102K-T	B	64.2/98.8
C484	4030007010	S.CER C1608 CH 1H 100D-T	B	64.3/108.1
C485	4030017810	S.CER C1608 CH 1H 102J-T	B	78.8/107.4
C501	4030006860	S.CER C1608 JB 1H 102K-T	T	109.3/87.9
C503	4030011070	S.CER GRM31M2C2H5R0CY21L (GRM42-6 CH)	T	119.4/130.3
C504	4030017960	S.CER ERF22X 6C2H 330J D01L	T	111.8/122.1
C505	4030011040	S.CER GRM31M4C2H2R0CY21L (GRM42-6 CK)	B	114.4/125.4
C506	4030011120	S.CER GRM31M2C2H100JV01L (GRM42-6 CH)	B	118.2/125.6
C507	4030011040	S.CER GRM31M4C2H2R0CY21L (GRM42-6 CK)	B	113.8/131.5
C508	4030011070	S.CER GRM31M2C2H5R0CY21L (GRM42-6 CH)	B	110.4/132.8
C509	4030007150	S.CER C1608 CH 1H 151J-T	B	110.2/121.5
C511	4030018770	S.CER C3216 CH 2J 102J-T	T	109.6/125.4
C513	4030006860	S.CER C1608 JB 1H 102K-T	B	97.1/117.6
C514	4030011170	S.CER GRM31M2C2H180JV01L (GRM42-6 CH)	T	98.4/118.1
C515	4030018770	S.CER C3216 CH 2J 102J-T	T	96.9/120.4
C516	4030011100	S.CER GRM31M2C2H8R0DV01L (GRM42-6 CH)	T	88.2/124.1
C517	4030004880	S.CER C2012 CH 1H 120J-T	B	92.5/115.1
C518	4030018770	S.CER C3216 CH 2J 102J-T	B	94.1/121.4
C519	4030011190	S.CER GRM31M2C2H270JV01L (GRM42-6 CH)	T	86.1/124.1
C520	4030004870	S.CER C2012 CH 1H 100D-T	B	93.4/112.4
C521	4030011290	S.CER GRM31M2C2H240JV01L (GRM42-6 CH)	T	81.2/123.9
C522	4030006850	S.CER C1608 JB 1H 471K-T	T	96.3/107.7
C523	4030006860	S.CER C1608 JB 1H 102K-T	T	79.3/119.1
C524	4030006910	S.CER C1608 CH 1H 0R5C-T	T	79.9/120.9
C525	4030004720	S.CER C2012 JB 1H 102K-T	T	86.7/112.1
C526	4030007150	S.CER C1608 CH 1H 151J-T	B	113.3/121.5
C527	4030007150	S.CER C1608 CH 1H 151J-T	B	111.1/127.8
C528	4030006860	S.CER C1608 JB 1H 102K-T	B	96.2/114.5
C530	4030011230	S.CER GRM31M2C2H390JV01L (GRM42-6 CH)	T	120.8/113.3
C531	4030018770	S.CER C3216 CH 2J 102J-T	B	106/109.3
C532	4030018770	S.CER C3216 CH 2J 102J-T	B	103.1/109.2
C533	4030018770	S.CER C3216 CH 2J 102J-T	T	118.6/107
C534	4030017880	S.CER ERF22X 6C2H 560J D01L (GRM111)	B	112.7/103.9

M.=Mounted side (T: Mounted on the Top side, B: Mounted on the Bottom side) S.=Surface mount

[PA UNIT]

REF NO.	PARTS NO.	DESCRIPTION	M.	H/V LOCATION
C535	4030017880	S.CER ERF22X 6C2H 560J D01L (GRM111)	B	124.1/103.9
C536	4030017980	S.CER ERF22X 6C2H 470J D01L	T	101/110.8
C537	4030017940	S.CER ERF22X 6C2H 680J D01L	T	101/114.2
C538	4030017880	S.CER ERF22X 6C2H 560J D01 (GRM111)	T	131.2/117.5
C541	4030011060	S.CER GRM31M2C2H4R0CY21L (GRM42-6 CH)	T	125.1/123.7
C542	4030012480	S.CER GRM31M2C2H121JV01L (GRM42-6 CH)	T	123.4/128.7
C544	4030011730	S.CER GRM31M2C2H101JV01L (GRM42-6 CH)	T	129.9/123.5
C545	4030017940	S.CER ERF22X 6C2H 680J D01L	B	112.7/109.9
C551	4030006880	S.CER C1608 JB 1H 472K-T	T	80.1/117.1
C552	4030006860	S.CER C1608 JB 1H 102K-T	T	73/120.5
C553	4030006850	S.CER C1608 JB 1H 471K-T	T	69.4/114.7
C554	4030006860	S.CER C1608 JB 1H 102K-T	T	66.8/114.7
C555	4030006860	S.CER C1608 JB 1H 102K-T	T	63.1/111.7
C556	4030011600	S.CER C1608 JB 1E 104K-T	T	68.3/111.2
C557	4030006860	S.CER C1608 JB 1H 102K-T	T	70.8/108.5
C558	4030006860	S.CER C1608 JB 1H 102K-T	T	65.4/108.6
C559	4030006860	S.CER C1608 JB 1H 102K-T	T	66/103.5
C560	4030006860	S.CER C1608 JB 1H 102K-T	B	65.3/112.9
C561	4030006850	S.CER C1608 JB 1H 471K-T	T	70.1/105.3
C562	4030006860	S.CER C1608 JB 1H 102K-T	T	69.2/94.9
C563	4030006860	S.CER C1608 JB 1H 102K-T	T	62.3/106.1
C564	4030006860	S.CER C1608 JB 1H 102K-T	T	65/97
C565	4030006860	S.CER C1608 JB 1H 102K-T	T	62.3/103
C567	4030006860	S.CER C1608 JB 1H 102K-T	T	69.2/120.9
C601	4030011070	S.CER GRM31M2C2H5R0CY21L (GRM42-6 CH)	T	69.5/132.7
C602	4030011090	S.CER GRM31M2C2H7R0DV01L (GRM42-6 CH)	T	67/136.8
C701	4030017320	S.CER GRM21BB11H104KA01L (GRM40-034)	B	109.8/33.4
C702	4030006860	S.CER C1608 JB 1H 102K-T	B	107.7/33.2
C703	4030011600	S.CER C1608 JB 1E 104K-T	B	83.8/16.9
C704	4510004601	ELE 16 ME 1000 HC		
C705	4030011600	S.CER C1608 JB 1E 104K-T	B	79/16.9
C706	4510004601	ELE 16 ME 1000 HC		
C707	4030017320	S.CER GRM21BB11H104KA01L (GRM40-034)	B	67.1/18.6
C708	4030006900	S.CER C1608 JB 1H 103K-T	T	63.2/27.8
C709	4030006860	S.CER C1608 JB 1H 102K-T	T	63.2/26.5
C710	4030006850	S.CER C1608 JB 1H 471K-T	T	63.2/25.2
C711	4030007170	S.CER C1608 CH 1H 221J-T	T	63.2/23.9
C712	4030007170	S.CER C1608 CH 1H 221J-T	B	70.4/18.7
C713	4510004591	ELE 16 ME 470 HC		
C715	4030006860	S.CER C1608 JB 1H 102K-T	B	97.1/118.9
C718	4030011600	S.CER C1608 JB 1E 104K-T	B	128.4/19.3
C719	4030011600	S.CER C1608 JB 1E 104K-T	T	125.8/16.4
C720	4030011600	S.CER C1608 JB 1E 104K-T	B	130.5/38.7
C722	4030007130	S.CER C1608 CH 1H 101J-T	T	88.9/17
C723	4030007130	S.CER C1608 CH 1H 101J-T	T	78.3/3.1
C724	4030011340	S.CER C1608 CH 1H 471J-T	B	134.8/12.2
C725	4550007350	S.TAN F931C226MCMCMBMA	B	126.6/35.3
C726	4030006860	S.CER C1608 JB 1H 102K-T	B	91.3/111
C727	4030006860	S.CER C1608 JB 1H 102K-T	B	84.4/114.1
C728	4030006860	S.CER C1608 JB 1H 102K-T	B	91.2/112.6
C729	4030006860	S.CER C1608 JB 1H 102K-T	B	65.1/114.8
C732	4030011600	S.CER C1608 JB 1E 104K-T	T	71.8/2.6
C733	4030011600	S.CER C1608 JB 1E 104K-T	T	66.8/12.9
C734	4030006860	S.CER C1608 JB 1H 102K-T	B	63.5/1.8
C735	4030011600	S.CER C1608 JB 1E 104K-T	T	74.1/13.2
C736	4030011600	S.CER C1608 JB 1E 104K-T	B	67.3/1.8
C737	4030011600	S.CER C1608 JB 1E 104K-T	B	65.4/1.8
C738	4030011600	S.CER C1608 JB 1E 104K-T	B	68.2/14.5
C739	4030011600	S.CER C1608 JB 1E 104K-T	B	69.8/14.5
C741	4030011600	S.CER C1608 JB 1E 104K-T	B	78.5/6.4
C742	4030011600	S.CER C1608 JB 1E 104K-T	T	69.4/12.9
C743	4030006860	S.CER C1608 JB 1H 102K-T	T	68.1/12.9
C744	4030011600	S.CER C1608 JB 1E 104K-T	T	70.7/12.9
C745	4030011600	S.CER C1608 JB 1E 104K-T	B	77.7/14.3
C746	4030011600	S.CER C1608 JB 1E 104K-T	B	76.2/15.1
C747	4030011600	S.CER C1608 JB 1E 104K-T	T	98.5/4.1
C749	4030011600	S.CER C1608 JB 1E 104K-T	T	96.6/6.4
C750	4030006880	S.CER C1608 JB 1H 472K-T	T	94.2/6.4
C751	4030006860	S.CER C1608 JB 1H 102K-T	T	95.4/6.4
C752	4030011600	S.CER C1608 JB 1E 104K-T	T	93/6.4
C753	4030006880	S.CER C1608 JB 1H 472K-T	B	59.9/10.7
C754	4030006860	S.CER C1608 JB 1H 102K-T	B	66.6/14.5
C755	4030006860	S.CER C1608 JB 1H 102K-T	B	58.5/119.2
C757	4030011600	S.CER C1608 JB 1E 104K-T	B	76.4/8
C759	4030006880	S.CER C1608 JB 1H 472K-T	T	72.8/13.2
C760	4030006880	S.CER C1608 JB 1H 472K-T	B	74.8/8
C761	4030006880	S.CER C1608 JB 1H 472K-T	B	73.2/8
C762	4030006880	S.CER C1608 JB 1H 472K-T	B	70/8
C763	4030006880	S.CER C1608 JB 1H 472K-T	B	71.6/8
C764	4030006880	S.CER C1608 JB 1H 472K-T	B	61.9/1.8
C765	4030011600	S.CER C1608 JB 1E 104K-T	B	68.9/1.8
C766	4030006860	S.CER C1608 JB 1H 102K-T	B	66.5/8.7
C781	4030006860	S.CER C1608 JB 1H 102K-T	T	73/90.1
C782	4030006900	S.CER C1608 JB 1H 103K-T	T	71.8/84.3
C783	4030006880	S.CER C1608 JB 1H 472K-T	T	71.8/83.1
C801	4030007070	S.CER C1608 CH 1H 330J-T	T	55/58.5
C802	4030009470	S.CER C1608 CH 1H R75C-T	T	53.7/58.5
C803	4030007100	S.CER C1608 CH 1H 560J-T	T	53.8/53.2
C804	4030007030	S.CER C1608 CH 1H 150J-T	T	56.2/52.5
C805	4030007080	S.CER C1608 CH 1H 390J-T	T	53.8/51.6

[PA UNIT]

REF NO.	PARTS NO.	DESCRIPTION	M.	H/V LOCATION
C806	4030006880	S.CER C1608 JB 1H 472K-T	B	47.1/39.8
C807	4030011600	S.CER C1608 JB 1E 104K-T	B	43.2/38.6
C808	4030011600	S.CER C1608 JB 1E 104K-T	B	43.1/44.5
C820	4030011600	S.CER C1608 JB 1E 104K-T	B	54.1/91.2
C821	4030006880	S.CER C1608 JB 1H 472K-T	B	53.5/99.2
C822	4030011510	S.CER GRM31M2C2H560JV01L (GRM42-6 CH)	B	42.2/21.9
C823	4030011190	S.CER GRM31M2C2H270JV01L (GRM42-6 CH)	B	32.9/18.3
C824	4030012480	S.CER GRM31M2C2H121JV01L (GRM42-6 CH)	B	25.1/17.1
C825	4030011240	S.CER GRM31M2C2H470JV01L (GRM42-6 CH)	B	17.9/15.7
C826	4030011550	S.CER GRM31M2C2H680JV01L (GRM42-6 CH)	B	11.2/19.9
C827	4030011510	S.CER GRM31M2C2H560JV01L (GRM42-6 CH)	B	8.8/19.9
C828	4030006880	S.CER C1608 JB 1H 472K-T	T	5.2/106.7
C829	4030011600	S.CER C1608 JB 1E 104K-T	T	2.6/106.7
C830	4030011210	S.CER GRM31M2C2H330JV01L (GRM42-6 CH)	B	22.4/17.1
C831	4030006880	S.CER C1608 JB 1H 472K-T	B	7.5/109.2
C832	4030006880	S.CER C1608 JB 1H 472K-T	B	51.5/95.4
C833	4030011730	S.CER GRM31M2C2H101JV01L (GRM42-6 CH)	B	27.5/17.1
C835	4030012480	S.CER GRM31M2C2H121JV01L (GRM42-6 CH)	B	16.6/107.1
C836	4030012480	S.CER GRM31M2C2H121JV01L (GRM42-6 CH)	B	12.5/107.8
C837	4030012480	S.CER GRM31M2C2H121JV01L (GRM42-6 CH)	B	12.5/105.7
C840	4030011600	S.CER C1608 JB 1E 104K-T	B	42.8/97.3
C841	4030006880	S.CER C1608 JB 1H 472K-T	B	46/98.5
C842	4030011730	S.CER GRM31M2C2H101JV01L (GRM42-6 CH)	B	39/106.8
C843	4010008160	CER HM13SJ SL 431J 500V 1		
C844	4030011730	S.CER GRM31M2C2H101JV01L (GRM42-6 CH)	B	25.9/102.9
C845	4030014460	S.CER GRM31M2C2H820JV01L (GRM42-6 CH)	B	19.7/91.9
C846	4010005370	CER HM11SJ SL 331J 500V 1		
C847	4010005930	CER HM11SJ SL 391J 500V 1		
C848	4030011190	S.CER GRM31M2C2H270JV01L (GRM42-6 CH)	B	12.5/98.2
C849	4030011180	S.CER GRM31M2C2H220JV01L (GRM42-6 CH)	B	12.6/96.1
C850	4010005930	CER HM11SJ SL 391J 500V 1		
C851	4030012480	S.CER GRM31M2C2H121JV01L (GRM42-6 CH)	B	20.2/112
C852	4030006880	S.CER C1608 JB 1H 472K-T	T	5.3/90.5
C853	4030011600	S.CER C1608 JB 1E 104K-T	T	2.6/90.5
C854	4030006880	S.CER C1608 JB 1H 472K-T	B	7.7/92.8
C855	4030011730	S.CER GRM31M2C2H101JV01L (GRM42-6 CH)	B	27.9/104.9
C856	4030011510	S.CER GRM31M2C2H560JV01L (GRM42-6 CH)	B	31.2/105.5
C857	4030012480	S.CER GRM31M2C2H121JV01L (GRM42-6 CH)	B	43.1/108.3
C858	4030011730	S.CER GRM31M2C2H101JV01L (GRM42-6 CH)	B	20.2/109.9
C860	4030011600	S.CER C1608 JB 1E 104K-T	B	43.4/83.8
C861	4030006880	S.CER C1608 JB 1H 472K-T	B	46.6/83.8
C863	4030011170	S.CER GRM31M2C2H180JV01L (GRM42-6 CH)	B	37.5/93.5
C864	4030011510	S.CER GRM31M2C2H560JV01L (GRM42-6 CH)	B	28.5/82.6
C865	4030011110	S.CER GRM31M2C2H9R0DV01L (GRM42-6 CH)	B	29.4/78.6
C866	4030011230	S.CER GRM31M2C2H390JV01L (GRM42-6 CH)	B	24.4/78
C868	4030011240	S.CER GRM31M2C2H470JV01L (GRM42-6 CH)	B	26.8/78.6
C869	4030011180	S.CER GRM31M2C2H220JV01L (GRM42-6 CH)	B	10.3/83.5
C870	4030011170	S.CER GRM31M2C2H180JV01L (GRM42-6 CH)	B	17/77.7
C871	4030006880	S.CER C1608 JB 1H 472K-T	T	5.2/74.4
C872	4030011600	S.CER C1608 JB 1E 104K-T	T	2.5/74.4
C873	4030011070	S.CER GRM31M2C2H5R0CY21L (GRM42-6 CH)	B	33.2/92.6
C874	4030006880	S.CER C1608 JB 1H 472K-T	B	9/74.5
C876	4030011160	S.CER GRM31M2C2H150JV01L (GRM42-6 CH)	B	22/77.4
C880	4030011600	S.CER C1608 JB 1E 104K-T	B	43.4/69.1
C881	4030006880	S.CER C1608 JB 1H 472K-T	B	47/69.1
C882	4010007590	CER HM15SJ SL 681J 500V 1		
C883	4010007590	CER HM15SJ SL 681J 500V 1		
C884	4010005930	CER HM11SJ SL 391J 500V 1		
C885	4320000320	DIP DM20C 222J5		
C886	4030012480	S.CER GRM31M2C2H121JV01L (GRM42-6 CH)	B	31.5/57.2
C887	4030011730	S.CER GRM31M2C2H101JV01L (GRM42-6 CH)	B	33.9/57.2
C889	4030014460	S.CER GRM31M2C2H820JV01L (GRM42-6 CH)	B	18/65.3
C890	4320001250	DIP DM19C 162J5		
C893	4030006880	S.CER C1608 JB 1H 472K-T	T	5.3/58.3
C894	4030011600	S.CER C1608 JB 1E 104K-T	T	2.6/58.3
C900	4030011600	S.CER C1608 JB 1E 104K-T	B	44/54.4

M.=Mounted side (T: Mounted on the Top side, B: Mounted on the Bottom side) S.=Surface mount

[PA UNIT]

REF NO.	PARTS NO.	DESCRIPTION	M.	H/V LOCATION
C901	4030006880	S.CER C1608 JB 1H 472K-T	B	46.8/54.4
C902	4010005870	CER HM95SJ SL 221J 500V 1		
C903	4030011190	S.CER GRM31M2C2H270JV01L (GRM42-6 CH)	B	30.9/42.7
C904	4030014460	S.CER GRM31M2C2H820JV01L (GRM42-6 CH)	B	28.4/42.7
C905	4010005870	CER HM95SJ SL 221J 500V 1		
C906	4030011510	S.CER GRM31M2C2H560JV01L (GRM42-6 CH)	B	17/44
C907	4030011510	S.CER GRM31M2C2H560JV01L (GRM42-6 CH)	B	10.8/49.5
C908	4030006880	S.CER C1608 JB 1H 472K-T	T	5.3/42.1
C909	4030011600	S.CER C1608 JB 1E 104K-T	B	2.6/42.1
C920	4030011600	S.CER C1608 JB 1E 104K-T	T	43.2/25.1
C921	4030006880	S.CER C1608 JB 1H 472K-T	B	47.1/25.4
C922	4010007590	CER HM15SJ SL 681J 500V 1		
C923	4030011730	S.CER GRM31M2C2H101JV01L (GRM42-6 CH)	B	31.4/27.3
C924	4010006410	CER HM13SJ SL 471J 500V 1		
C925	4030014460	S.CER GRM31M2C2H820JV01L (GRM42-6 CH)	B	15.7/29.5
C926	4010006410	CER HM13SJ SL 471J 500V 1		
C927	4010005930	CER HM11SJ SL 391J 500V 1		
C928	4010005930	CER HM11SJ SL 391J 500V 1		
C929	4030006880	S.CER C1608 JB 1H 472K-T	T	5.3/25.8
C930	4030011600	S.CER C1608 JB 1E 104K-T	T	2.6/25.8
C931	4030014460	S.CER GRM31M2C2H820JV01L (GRM42-6 CH)	B	34.1/27.3
C932	4030011730	S.CER GRM31M2C2H101JV01L (GRM42-6 CH)	B	33.3/32.4
C933	4030011730	S.CER GRM31M2C2H101JV01L (GRM42-6 CH)	B	29.7/30.9
C940	4030011600	S.CER C1608 JB 1E 104K-T	B	43.6/11.1
C941	4030006880	S.CER C1608 JB 1H 472K-T	B	43.6/14.2
C942	4030014460	S.CER GRM31M2C2H820JV01L (GRM42-6 CH)	B	39.5/119.2
C943	4030011210	S.CER GRM31M2C2H330JV01L (GRM42-6 CH)	B	28.9/111.7
C944	4030014460	S.CER GRM31M2C2H820JV01L (GRM42-6 CH)	B	24.7/118.4
C945	4030011170	S.CER GRM31M2C2H180JV01L (GRM42-6 CH)	B	16.5/118.1
C947	4030006880	S.CER C1608 JB 1H 472K-T	T	5.3/9.9
C948	4030011600	S.CER C1608 JB 1E 104K-T	T	2.6/9.9
C949	4030011050	S.CER GRM31M3C2H3R0CY21L (GRM42-6 CJ)	B	28.9/109.6
C960	4030010760	S.CER C1608 CH 1H 331J-T	T	18.1/130.2
C961	4030011600	S.CER C1608 JB 1E 104K-T	B	45.1/134.1
C962	4030006880	S.CER C1608 JB 1H 472K-T	B	39/137.8
C963	4030006880	S.CER C1608 JB 1H 472K-T	B	38.7/126.3
C964	4610002120	S.TRI TZB4Z100EB10R00 (TZBX4Z100BE110)	T	3.3/126.6
C966	4030006880	S.CER C1608 JB 1H 472K-T	B	21.2/131.2
C968	4030011340	S.CER C1608 CH 1H 471J-T	B	31/130.5
C969	4030011340	S.CER C1608 CH 1H 471J-T	B	31/133.6
C970	4030010760	S.CER C1608 CH 1H 331J-T	B	22/132.8
C971	4030011340	S.CER C1608 CH 1H 471J-T	B	35.8/133.6
C972	4030011790	S.CER GRM55RF52A684ZD01L (GRM44-1)	B	3.4/136.4
C973	4030007090	S.CER C1608 CH 1H 470J-T	B	8.3/129.8
C979	4030006880	S.CER C1608 JB 1H 472K-T	T	51.8/38.6
C987	4030006880	S.CER C1608 JB 1H 472K-T	B	28.9/3.3
C988	4030006880	S.CER C1608 JB 1H 472K-T	B	26.3/3.3
C989	4030006880	S.CER C1608 JB 1H 472K-T	B	25/2.6
C990	4030006880	S.CER C1608 JB 1H 472K-T	T	20.6/3
C991	4030006880	S.CER C1608 JB 1H 472K-T	T	20.6/4.2
C992	4030006880	S.CER C1608 JB 1H 472K-T	T	20.6/5.4
C993	4030006880	S.CER C1608 JB 1H 472K-T	T	20.6/6.6
C994	4030011600	S.CER C1608 JB 1E 104K-T	B	29.5/6.1
C995	4030006880	S.CER C1608 JB 1H 472K-T	B	23.7/3.4
C996	4030007090	S.CER C1608 CH 1H 470J-T	T	20.6/9
C997	4030007090	S.CER C1608 CH 1H 470J-T	T	20.6/7.8
C998	4030007090	S.CER C1608 CH 1H 470J-T	T	20.6/10.2
C999	4030006860	S.CER C1608 JB 1H 102K-T	T	56.8/9.5
C1000	4030006860	S.CER C1608 JB 1H 102K-T	B	55.5/5
C1001	4030011600	S.CER C1608 JB 1E 104K-T	B	51.6/1.7
C1002	4030006880	S.CER C1608 JB 1H 472K-T	B	27.6/2.6
C1003	4030011600	S.CER C1608 JB 1E 104K-T	T	49.8/7.6
C1004	4030011510	S.CER GRM31M2C2H560JV01L (GRM42-6 CH)	B	39.8/21.9
C1005	4030011550	S.CER GRM31M2C2H680JV01L (GRM42-6 CH)	B	16.8/91.9
C1006	4030014460	S.CER GRM31M2C2H820JV01L (GRM42-6 CH)	B	39/109.2
C1007	4030011550	S.CER GRM31M2C2H680JV01L (GRM42-6 CH)	B	18.1/62.1
C1009	4030011510	S.CER GRM31M2C2H560JV01L (GRM42-6 CH)	B	20.6/118.7
C1010	4030014460	S.CER GRM31M2C2H820JV01L (GRM42-6 CH)	B	27.1/119.5
C1121	4010006410	CER HM13SJ SL 471J 500V 1		
RL701	6330001550	REL JV-12-KT		
RL801	6330001721	REL ATN207-K1		
RL820	6330001721	REL ATN207-K1		
RL821	6330001721	REL ATN207-K1		
RL840	6330001721	REL ATN207-K1		
RL841	6330001721	REL ATN207-K1		

[PA UNIT]

REF NO.	PARTS NO.	DESCRIPTION	M.	H/V LOCATION
RL860	6330001721	REL ATN207-K1		
RL861	6330001721	REL ATN207-K1		
RL880	6330001721	REL ATN207-K1		
RL881	6330001721	REL ATN207-K1		
RL900	6330001721	REL ATN207-K1		
RL901	6330001721	REL ATN207-K1		
RL920	6330001721	REL ATN207-K1		
RL921	6330001721	REL ATN207-K1		
RL940	6330001721	REL ATN207-K1		
RL941	6330001721	REL ATN207-K1		
J2	6510023511	S.CON 28FLT-SM2-TB(LF)(SN) 2	T	80.1/6
J980	6510023511	S.CON 28FLT-SM2-TB(LF)(SN) 2	T	63.7/6
F1	5220000341	HOL FHA010-03F		
F2	5210000940	FUS 1205		
W701	8900013900	CAB OPC-1455		
W702	8900013910	CAB OPC-1456		
W801	7120000480	S.JUM MJP-0.4-T	B	8.3/100.9
W901	7120000480	S.JUM MJP-0.4-T	T	56.7/22
EP202	6910012350	S.BEA MMZ1608Y 102BT	B	136/51.3
EP703	6910012350	S.BEA MMZ1608Y 102BT	B	142.6/13.9
EP741	6910012350	S.BEA MMZ1608Y 102BT	B	76.4/11.9
EP742	6910012350	S.BEA MMZ1608Y 102BT	B	77.8/11.3
EP743	6910012350	S.BEA MMZ1608Y 102BT	B	59.8/99.5
EP747	6910012350	S.BEA MMZ1608Y 102BT	T	65/9.6
EP748	6910012350	S.BEA MMZ1608Y 102BT	T	63.8/9.6
EP751	6910012350	S.BEA MMZ1608Y 102BT	T	74.1/9.6
EP752	6910012350	S.BEA MMZ1608Y 102BT	B	63.4/5.2
EP753	6910012350	S.BEA MMZ1608Y 102BT	T	66.4/9.6
EP754	6910012350	S.BEA MMZ1608Y 102BT	B	59.3/115.8
EP756	6910012350	S.BEA MMZ1608Y 102BT	T	68.6/2.6
EP758	6910012350	S.BEA MMZ1608Y 102BT	T	70.3/9.6
EP759	6910012350	S.BEA MMZ1608Y 102BT	T	69.1/9.6
EP760	6910012350	S.BEA MMZ1608Y 102BT	T	60.6/10
EP761	6910012350	S.BEA MMZ1608Y 102BT	T	62.5/9.6
EP762	6910012350	S.BEA MMZ1608Y 102BT	B	61/4.6
EP763	6910012350	S.BEA MMZ1608Y 102BT	B	63.3/105.6
EP767	6910012350	S.BEA MMZ1608Y 102BT	B	76.4/5.2
EP772	6910012350	S.BEA MMZ1608Y 102BT	T	96.4/3.8
EP774	6910012350	S.BEA MMZ1608Y 102BT	T	72.8/9.6
EP775	6910012350	S.BEA MMZ1608Y 102BT	B	74.8/5.2
EP776	6910012350	S.BEA MMZ1608Y 102BT	B	73.2/5.2
EP777	6910012350	S.BEA MMZ1608Y 102BT	B	70/5.2
EP778	6910012350	S.BEA MMZ1608Y 102BT	B	71.6/5.2
EP779	6910012350	S.BEA MMZ1608Y 102BT	B	68.2/5.2

M.=Mounted side (T: Mounted on the Top side, B: Mounted on the Bottom side)
S.=Surface mount

[DRIVER UNIT]

REF NO.	PARTS NO.	DESCRIPTION	M.	H/V LOCATION
Q504	1590003061	S.FET PD55015-E	T	20/9.7
R102	7070000271	RES ERG1SJ 101 (100)		
C101	4030004750	S.CER C2012 JB 1H 103K-T	T	24.6/18.2
C102	4030011230	S.CER GRM31M2C2H390JV01L (GRM42-6 CH)	T	11.2/4.2
J101	6910016830	CON IMSA-9230B-1-04Z149-PT1		
J102	6910016830	CON IMSA-9230B-1-04Z149-PT1		
J103	6910016830	CON IMSA-9230B-1-04Z149-PT1		
J104	6910016830	CON IMSA-9230B-1-04Z149-PT1		
J107	6910016830	CON IMSA-9230B-1-04Z149-PT1		
MP1	8410002480	S.HEA 2429 PA HEATSINK	B	20/9.7

[DISPLAY UNIT]

REF NO.	PARTS NO.	DESCRIPTION	M.	H/V LOCATION
IC1	6910016730	S.DC XC9504B092ARN	B	44.4/9.4
IC101	1180001071	S.IC TA7805F(TE16L,Q)	B	90.3/6.9
IC151	1180002201	S.IC RN5FZ33BA-TR-F	B	99.9/4.8
IC301	1110002751	S.IC TA75S01F(TE85R,F)	B	113.8/7.5
IC506	1120003010	S.IC ANE253FH-V	B	69/38.5
IC651	1110005420	S.IC BA15532F-E2	B	4.1/25.6
IC2003	1140013140	S.IC HD64338020SB68HV(SX-2427C)	B	93/26.3
IC2007	1110005821	S.IC R3112N281A-TR-F	B	108.7/46.9
Q1	1550000090	S.FET RSQ035P03TR	B	39.4/9.8
Q51	1560001330	S.FET RSR025N03	B	52.1/10.6
Q301	1560001290	S.FET 2SK3065 T100	T	110.8/31.4
Q302	1590003940	S.TRA RN1105(TE85L,F)	T	116.7/10.2
Q303	1590003930	S.TRA UMD22N TR	T	113.1/11.5
Q651	1590001650	S.TRA XP4601(TX)	B	10.6/28.8
Q652	1590001650	S.TRA XP4601(TX)	B	11.1/20.6
Q653	1590001650	S.TRA XP4601(TX)	B	10.6/26.2
Q654	1590001650	S.TRA XP4601(TX)	B	11.1/17
Q701	1530002060	S.TRA 2SC4081 T106 R	T	19.1/50.3
Q721	1530002060	S.TRA 2SC4081 T106 R	T	22/5.8
Q741	1530002060	S.TRA 2SC4081 T106 R	T	94/50.1
Q761	1530002060	S.TRA 2SC4081 T106 R	T	104.2/50.1
Q771	1530002060	S.TRA 2SC4081 T106 R	T	18.4/25.1
Q781	1530002060	S.TRA 2SC4081 T106 R	T	5.3/23.6
Q802	1520000460	S.TRA 2SB1132 T100 R	B	58.8/21.6
Q851	1590002771	S.FET CPH3404-TL-E	B	39.9/18.4
Q2001	1590003940	S.TRA RN1105(TE85L,F)	B	81.6/23.7
Q2002	1590001870	S.TRA DTA114EE TL	B	80.1/29.7
Q2003	1590003480	S.TRA DTC114TE TL	B	82.2/32.3
D1	1790000970	S.DIO MA729(TX)	B	36.8/10.1
D51	1750000730	S.DIO MA25D1000L	B	51/8
D301	1790001250	S.DIO MA2S111-(TX)	B	111/32
D302	1790001520	S.ZEN MA8075-L(TX)	B	109.9/7.6
D601	1750000950	S.DIO MA732(TX)	B	51.5/39.8
D602	1750000950	S.DIO MA732(TX)	B	53.3/39.8
D801	1730002340	S.ZEN MA8047-M(TX)	B	35/40.4
D802	1730002340	S.ZEN MA8047-M(TX)	B	39.8/25.9
D803	1730002340	S.ZEN MA8047-M(TX)	B	39.5/22.8
D804	1730002340	S.ZEN MA8047-M(TX)	B	42/22.9
D2001	1750000950	S.DIO MA732(TX)	T	107.4/26.5
D2002	1790001670	S.DIO RB706F-40T106	B	76.6/16.8
D2003	1790001670	S.DIO RB706F-40T106	T	116.4/36.7
D2004	1750000370	S.DIO DA221 TL	T	100.6/41.8
D2005	1750000370	S.DIO DA221 TL	B	101.7/42.8
D2006	1750000370	S.DIO DA221 TL	B	107.3/5.9
X501	6050012150	S.XTA CR-806 SMD-49TA 4.433619MHz [EUR]	B	87/43.5
	6050012150	S.XTA CR-806 SMD-49TA 4.433619 MHz [FRA]		
	6050012150	S.XTA CR-806 SMD-49TA 4.433619 MHz [ESP]		
	6050012140	S.XTA CR-805 SMD-49TA 3.579545 MHz [USA]		
	6050012150	S.XTA CR-806 SMD-49TA 4.433619 MHz [EXP]		
	6050012150	S.XTA CR-806 SMD-49TA 4.433619 MHz [ITR]		
	6050012150	S.XTA CR-806 SMD-49TA 4.433619 MHz [UK]		
	6050012140	S.XTA CR-805 SMD-49TA 3.579545 MHz [KOR]		
	6050012150	S.XTA CR-806 SMD-49TA 4.433619 MHz [AUS]		
	6050012150	S.XTA CR-806 SMD-49TA 4.433619 MHz [CHN]		
X2001	6050011550	S.XTA CR-747 SMD-49TA 9.8304 MHz	B	106.5/27

[DISPLAY UNIT]

REF NO.	PARTS NO.	DESCRIPTION	M.	H/V LOCATION
L1	6190001561	S.COI CDRH5D18NP-101NC	B	68.4/6.3
L2	6190001561	S.COI CDRH5D18NP-101NC	B	34.6/5.2
L3	6200002041	S.COI NLV25T-101J	B	30.7/10.4
L51	6190001561	S.COI CDRH5D18NP-101NC	B	55.9/6.2
L53	6200002041	S.COI NLV25T-101J	B	60.9/10.9
L101	6200001831	S.COI NLV32T-100J	B	96/11.6
L151	6200001831	S.COI NLV32T-100J	B	96/8.6
L152	6200001831	S.COI NLV32T-100J	B	100.6/11.4
L251	6200003950	S.COI HF50ACC 322513-T	B	145.8/44
L252	6200003950	S.COI HF50ACC 322513-T	B	145.2/50.9
L301	6200002041	S.COI NLV25T-101J	B	109.6/16.7
L302	6200005011	S.COI NLV25T-100J	T	112.6/24
L303	6200002041	S.COI NLV25T-101J	T	112/20.3
L306	6200003261	S.COI NLV32T-101J	T	109.8/25.5
L307	6200002041	S.COI NLV25T-101J	T	115.4/26.6
L309	6200002041	S.COI NLV25T-101J	T	115.3/24
L310	6200002041	S.COI NLV25T-101J	T	115.4/21.5
L312	6200002041	S.COI NLV25T-101J	T	115.4/19
L313	6200002041	S.COI NLV25T-101J	T	115.7/16.3
L505	6200005521	S.COI NLV25T-470J	B	71.2/47.9
L506	6200005011	S.COI NLV25T-100J	B	67.9/20.2
L507	6200005011	S.COI NLV25T-100J	B	50.2/29
L508	6200005011	S.COI NLV25T-100J	B	49.3/24.3
L509	6200005011	S.COI NLV25T-100J	B	17.4/35.6
L601	6200002041	S.COI NLV25T-101J	B	70.6/25.2
L602	6200005011	S.COI NLV25T-100J	B	53.5/36.2
L603	6200005011	S.COI NLV25T-100J	B	51/43.3
L604	6200005011	S.COI NLV25T-100J	B	53.5/43.3
L605	6200005011	S.COI NLV25T-100J	B	50.9/36.2
L651	6200002041	S.COI NLV25T-101J	B	19.1/42.7
L701	6200002041	S.COI NLV25T-101J	B	21.1/37.5
L702	6200002041	S.COI NLV25T-101J	B	65.4/10.9
L703	6200002041	S.COI NLV25T-101J	B	27.9/11.3
L801	6200005011	S.COI NLV25T-100J	B	63.4/16.9
L802	6200002041	S.COI NLV25T-101J	B	19.1/47.5
L851	6200003950	S.COI HF50ACC 322513-T	B	33.2/17.2
L852	6200003950	S.COI HF50ACC 322513-T	B	35/21.3
L853	6200002041	S.COI NLV25T-101J	B	34.4/26.6
L854	6200002041	S.COI NLV25T-101J	B	34.4/24.1
L855	6200003950	S.COI HF50ACC 322513-T	B	36.4/17.2
R1	7030008141	S.RES ERA3YKD 224V (220K)	B	33.4/9.6
R2	7030005671	S.RES ERA3YKD 393V (39K)	B	33.4/11.6
R3	7030008051	S.RES ERA3YKD 184V (180K)	B	42.6/6.4
R4	7030005050	S.RES ERJ2GEJ 103 X (10K)	B	40.9/6.8
R5	7030005050	S.RES ERJ2GEJ 103 X (10K)	B	40.9/7.7
R51	7030008141	S.RES ERA3YKD 224V (220K)	B	49.7/10.8
R52	7030007911	S.RES ERA3YKD 563V (56K)	B	48.5/10.8
R53	7030006561	S.RES ERA3YED 223V (22K)	B	46.5/11.8
R54	7030005050	S.RES ERJ2GEJ 103 X (10K)	B	47.9/8.4
R55	7030005050	S.RES ERJ2GEJ 103 X (10K)	B	48.8/8.4
R201	7030010040	S.RES ERJ2GEJ-JPW	B	109.6/39
R202	7030010040	S.RES ERJ2GEJ-JPW	B	109.6/39
R251	7030005120	S.RES ERJ2GEJ 102 X (1K)	B	136.5/49.6
R252	7030000300	S.RES MCR10EZHZ 220 (221)	B	133.9/47.3
R253	7030000300	S.RES MCR10EZHZ 220 (221)	B	141.3/51.5
R254	7030000300	S.RES MCR10EZHZ 220 (221)	B	133.9/49
R255	7030000300	S.RES MCR10EZHZ 220 (221)	T	142.6/51.4
R301	7030005120	S.RES ERJ2GEJ 102 X (1K)	B	113.2/32
R302	7030005050	S.RES ERJ2GEJ 103 X (10K)	T	114/30.4
R303	7030005120	S.RES ERJ2GEJ 102 X (1K)	B	111/33.4
R304	7030007300	S.RES ERJ2GEJ 332 X (3.3K)	B	111.9/30.4
R305	7030007300	S.RES ERJ2GEJ 332 X (3.3K)	B	113.2/32.9
R306	7030005120	S.RES ERJ2GEJ 102 X (1K)	T	114.9/11
R307	7030005050	S.RES ERJ2GEJ 103 X (10K)	B	111.3/8.4
R308	7030005230	S.RES ERJ2GEJ 334 X (330K)	B	113.8/5.3
R309	7030005310	S.RES ERJ2GEJ 124 X (120K)	B	112/5.3
R310	7030008010	S.RES ERJ2GEJ 123 X (12K)	B	110.2/5.3
R521	7030008370	S.RES ERJ2GEJ 561 X (560)	B	61.8/46.2
R522	7030010040	S.RES ERJ2GEJ-JPW	B	65.3/47.4
R523	7030010040	S.RES ERJ2GEJ-JPW	B	65.4/48.7
R524	7030010900	S.RES ERJ3GEYJ 750 V (75)	B	63.1/48.9
R528	7030010040	S.RES ERJ2GEJ-JPW	B	60.8/42.6
R529	7030005050	S.RES ERJ2GEJ 103 X (10K)	B	58.6/43.8
R530	7030005080	S.RES ERJ2GEJ 823 X (82K)	B	60.8/43.6
R531	7030009290	S.RES ERJ2GEJ 562 X (5.6K)	B	76.3/42.9
R532	7030005050	S.RES ERJ2GEJ 103 X (10K)	B	60.8/37.2
R533	7030010040	S.RES ERJ2GEJ-JPW	B	56.5/32.3
R534	7030010040	S.RES ERJ2GEJ-JPW	B	60.8/36
R536	7030010040	S.RES ERJ2GEJ-JPW	B	62.6/29
R537	7030010040	S.RES ERJ2GEJ-JPW	B	64.6/29
R538	7030010040	S.RES ERJ2GEJ-JPW	B	66.6/29
R539	7030005720	S.RES ERJ2GEJ 563 X (56K)	B	69.6/29
R540	7030010040	S.RES ERJ2GEJ-JPW	B	68.6/29
R541	7310004650	S.TRI EVM-2WSX80 B53 (502)	B	53.3/49.2
R544	7030010040	S.RES ERJ2GEJ-JPW	B	60.8/39.6
R545	7030005720	S.RES ERJ2GEJ 563 X (56K)	B	60.8/32
R546	7030010040	S.RES ERJ2GEJ-JPW	B	60.8/34
R547	7030010040	S.RES ERJ2GEJ-JPW	B	59.2/34.8
R548	7030010040	S.RES ERJ2GEJ-JPW	B	60.8/33
R549	7030010040	S.RES ERJ2GEJ-JPW	B	63.6/29
R550	7030010040	S.RES ERJ2GEJ-JPW	B	65.6/29
R551	7030010040	S.RES ERJ2GEJ-JPW	B	67.6/29
R553	7030010040	S.RES ERJ2GEJ-JPW	B	59.5/43.8
R601	7030008410	S.RES ERJ2GEJ 392 X (3.9K)	B	72.7/24.9
R602	7030008410	S.RES ERJ2GEJ 392 X (3.9K)	B	74.5/24.9
R603	7030008410	S.RES ERJ2GEJ 392 X (3.9K)	B	75.4/24.9
R604	7030008410	S.RES ERJ2GEJ 392 X (3.9K)	B	77.2/24.9

M.=Mounted side (T: Mounted on the Top side, B: Mounted on the Bottom side) S.=Surface mount

[DISPLAY UNIT]

REF NO.	PARTS NO.	DESCRIPTION	M.	H/V LOCATION
R605	7030008410	S.RES ERJ2GEJ 392 X (3.9K)	B	75.3/30.2
R606	7030008410	S.RES ERJ2GEJ 392 X (3.9K)	B	76.3/24.9
R608	7030010040	S.RES ERJ2GEJ-JPW	B	48.8/36.8
R609	7030005040	S.RES ERJ2GEJ 472 X (4.7K)	B	48.4/44.4
R610	7030010040	S.RES ERJ2GEJ-JPW	B	48.8/41.7
R612	7030005040	S.RES ERJ2GEJ 472 X (4.7K)	B	48.8/42.6
R613	7030003470	S.RES ERJ3GEYJ 182 V (1.8K)	B	52.6/46.1
R614	7030003470	S.RES ERJ3GEYJ 182 V (1.8K)	B	50.7/46.3
R651	7030005050	S.RES ERJ2GEJ 103 X (10K)	B	5.5/19.6
R652	7030005220	S.RES ERJ2GEJ 223 X (22K)	B	8.1/25.7
R653	7030005060	S.RES ERJ2GEJ 333 X (33K)	B	5.5/21.4
R654	7030005070	S.RES ERJ2GEJ 683 X (68K)	B	8.1/23.9
R655	7030005090	S.RES ERJ2GEJ 104 X (100K)	B	4.1/30.7
R656	7030005110	S.RES ERJ2GEJ 224 X (220K)	B	8.1/27.4
R657	7030005060	S.RES ERJ2GEJ 333 X (33K)	B	1.8/30.3
R658	7030005090	S.RES ERJ2GEJ 104 X (100K)	B	4.1/29.8
R659	7030003600	S.RES ERJ3GEYJ 223 V (22K)	B	8.4/28.5
R660	7030005720	S.RES ERJ2GEJ 563 X (56K)	B	13.2/29.9
R661	7030005220	S.RES ERJ2GEJ 223 X (22K)	B	13.7/27.1
R662	7030007350	S.RES ERJ2GEJ 393 X (39K)	B	13.7/28.7
R663	7030005220	S.RES ERJ2GEJ 223 X (22K)	B	13.2/20.6
R664	7030007340	S.RES ERJ2GEJ 153 X (15K)	B	5.7/29.8
R665	7030003600	S.RES ERJ3GEYJ 223 V (22K)	B	8.9/20.6
R666	7030004980	S.RES ERJ2GEJ 101 X (100)	B	13.1/25.3
R667	7030004980	S.RES ERJ2GEJ 101 X (100)	B	11.1/18.8
R668	7030004980	S.RES ERJ2GEJ 101 X (100)	B	9.7/24.2
R669	7030004980	S.RES ERJ2GEJ 101 X (100)	B	13.6/16.2
R701	7030004990	S.RES ERJ2GEJ 221 X (220)	T	18.4/48
R702	7030007280	S.RES ERJ2GEJ 331 X (330)	T	19.7/48
R703	7030007290	S.RES ERJ2GEJ 222 X (2.2K)	T	25.1/41
R704	7030005040	S.RES ERJ2GEJ 472 X (4.7K)	T	16.6/17.2
R705	7030007340	S.RES ERJ2GEJ 153 X (15K)	T	18.7/6.4
R721	7030004990	S.RES ERJ2GEJ 221 X (220)	T	20.2/6.2
R722	7030007280	S.RES ERJ2GEJ 331 X (330)	T	23.8/5.6
R723	7030003480	S.RES ERJ3GEYJ 222 V (2.2K)	T	47.5/2.4
R724	7030003520	S.RES ERJ3GEYJ 472 V (4.7K)	T	61.8/2.4
R725	7030003580	S.RES ERJ3GEYJ 153 V (15K)	T	75.9/2.4
R741	7030004990	S.RES ERJ2GEJ 221 X (220)	T	92.2/49.7
R742	7030007280	S.RES ERJ2GEJ 331 X (330)	T	95.7/49.6
R743	7030007290	S.RES ERJ2GEJ 222 X (2.2K)	T	102.1/35
R744	7030005040	S.RES ERJ2GEJ 472 X (4.7K)	T	102.1/25.5
R745	7030007340	S.RES ERJ2GEJ 153 X (15K)	T	100.6/8.6
R761	7030004990	S.RES ERJ2GEJ 221 X (220)	T	103.1/48.2
R762	7030007280	S.RES ERJ2GEJ 331 X (330)	T	104.8/47.8
R771	7030004990	S.RES ERJ2GEJ 221 X (220)	T	18.7/28.9
R772	7030007280	S.RES ERJ2GEJ 331 X (330)	T	18.1/29.9
R781	7030004990	S.RES ERJ2GEJ 221 X (220)	T	3.5/22.4
R782	7030007280	S.RES ERJ2GEJ 331 X (330)	T	3.5/24.2
R801	7030005240	S.RES ERJ2GEJ 473 X (47K)	B	62/21.8
R802	7030007270	S.RES ERJ2GEJ 151 X (150)	B	62/20
R803	7030005120	S.RES ERJ2GEJ 102 X (1K)	B	62/23.6
R2002	7030005240	S.RES ERJ2GEJ 473 X (47K)	T	110.4/40.7
R2003	7030005050	S.RES ERJ2GEJ 103 X (10K)	T	24.6/24.1
R2004	7030005050	S.RES ERJ2GEJ 103 X (10K)	T	24.6/26.3
R2005	7030005050	S.RES ERJ2GEJ 103 X (10K)	T	24.6/23.2
R2006	7030005050	S.RES ERJ2GEJ 103 X (10K)	T	24.6/25.3
R2007	7030007290	S.RES ERJ2GEJ 222 X (2.2K)	T	107.6/24.4
R2008	7030005220	S.RES ERJ2GEJ 223 X (22K)	T	78.2/18.4
R2009	7030005240	S.RES ERJ2GEJ 473 X (47K)	T	107.8/33
R2010	7030005090	S.RES ERJ2GEJ 104 X (100K)	B	79.6/16.9
R2011	7030005160	S.RES ERJ2GEJ 105 X (1M)	B	103.3/26.9
R2012	7030008010	S.RES ERJ2GEJ 123 X (12K)	B	103.3/23.3
R2013	7030005240	S.RES ERJ2GEJ 473 X (47K)	B	96.7/37.9
R2014	7030005290	S.RES ERJ2GEJ 682 X (6.8K)	T	24.1/41
R2015	7030005050	S.RES ERJ2GEJ 103 X (10K)	B	106/44.6
R2016	7030005240	S.RES ERJ2GEJ 473 X (47K)	B	92.1/37.9
R2017	7030005290	S.RES ERJ2GEJ 682 X (6.8K)	T	33.4/3.7
R2018	7030005290	S.RES ERJ2GEJ 682 X (6.8K)	T	102.2/41.8
R2019	7030005240	S.RES ERJ2GEJ 473 X (47K)	B	84.8/33.8
R2020	7030003450	S.RES ERJ3GEYJ 122 V (1.2K)	B	91.2/43.1
R2021	7030005240	S.RES ERJ2GEJ 473 X (47K)	B	97.1/40.8
R2022	7030005240	S.RES ERJ2GEJ 473 X (47K)	B	92.3/42.3
R2023	7030005240	S.RES ERJ2GEJ 473 X (47K)	B	100.1/42.8
R2024	7030005240	S.RES ERJ2GEJ 473 X (47K)	B	94.3/42.3
R2025	7030005240	S.RES ERJ2GEJ 473 X (47K)	B	93.3/42.3
R2026	7030005240	S.RES ERJ2GEJ 473 X (47K)	B	72.4/16.7
R2027	7030005240	S.RES ERJ2GEJ 473 X (47K)	B	70.6/16.9
R2028	7030005240	S.RES ERJ2GEJ 473 X (47K)	B	98.9/42.8
R2029	7030005240	S.RES ERJ2GEJ 473 X (47K)	B	73.5/16.7
R2030	7030007270	S.RES ERJ2GEJ 151 X (150)	T	108/11.8
R2031	7030007280	S.RES ERJ2GEJ 331 X (330)	T	108.8/40.1
R2033	7030007270	S.RES ERJ2GEJ 151 X (150)	T	19.4/20.3
R2034	7030005120	S.RES ERJ2GEJ 102 X (1K)	B	32.1/28.3
R2035	7030005120	S.RES ERJ2GEJ 102 X (1K)	B	32.5/30.9
R2036	7030005240	S.RES ERJ2GEJ 473 X (47K)	B	94.9/37.9
R2037	7030005240	S.RES ERJ2GEJ 473 X (47K)	B	93.9/37.9
R2039	7030005240	S.RES ERJ2GEJ 473 X (47K)	B	107.6/23.5
R2040	7030007340	S.RES ERJ2GEJ 153 X (15K)	B	116.3/8.7
R2041	7030007340	S.RES ERJ2GEJ 153 X (15K)	B	116.2/7.7
R2042	7030005050	S.RES ERJ2GEJ 103 X (10K)	B	79.7/31.3
R2043	7030005090	S.RES ERJ2GEJ 104 X (100K)	B	81.9/30.4
C2	4030018960	S.CER C3216 JB 1C 106MT-N	B	62.2/7
C3	4030018960	S.CER C3216 JB 1C 106MT-N	B	77/9.8
C4	4030017420	S.CER ECJ0EC1H470J	B	35.3/10.6
C6	4030018960	S.CER C3216 JB 1C 106MT-N	B	28/6
C8	4030018960	S.CER C3216 JB 1C 106MT-N	B	30.1/6
C9	4030018960	S.CER C3216 JB 1C 106MT-N	B	39.1/4.4

[DISPLAY UNIT]

REF NO.	PARTS NO.	DESCRIPTION	M.	H/V LOCATION	
C51	4030017420	S.CER ECJ0EC1H470J	B	49.7/8.4	
C53	4030018960	S.CER C3216 JB 1C 106MT-N	B	51.6/4.3	
C55	4030018960	S.CER C3216 JB 1C 106MT-N	B	56.2/11	
C56	4030018960	S.CER C3216 JB 1C 106MT-N	B	61.9/3.6	
C57	4030017490	S.CER C1608 JB 1A 105K-T	B	43.9/11.8	
C101	4030018960	S.CER C3216 JB 1C 106MT-N	B	85.7/6.8	
C102	4030018960	S.CER C3216 JB 1C 106MT-N	B	94.7/4.6	
C103	4030016930	S.CER ECJ0EB1A104K	B	91.1/12.2	
C104	4030016930	S.CER ECJ0EB1A104K	B	89.5/12.2	
C151	4550006250	S.TAN TEESVA 1A 106M8R	B	97/4.6	
C152	4550006250	S.TAN TEESVA 1A 106M8R	B	100.7/7.7	
C153	4030016930	S.CER ECJ0EB1A104K	B	99.7/2.6	
C154	4030016930	S.CER ECJ0EB1A104K	B	99.6/9.3	
C251	4030017730	S.CER ECJ0EB1E471K	B	147.5/46.4	
C252	4030017730	S.CER ECJ0EB1E471K	B	146.5/48.3	
C253	4030017730	S.CER ECJ0EB1E471K	B	144.7/48.3	
C254	4030017730	S.CER ECJ0EB1E471K	B	144.4/46.4	
C255	4030017490	S.CER C1608 JB 1A 105K-T	T	147.1/51	
C256	4030017490	S.CER C1608 JB 1A 105K-T	B	134.1/45.7	
C301	4030017780	S.CER ECJ0EB1E472K	T	108.3/19.9	
C302	4030017780	S.CER ECJ0EB1E472K	T	108.2/28.7	
C303	4030006880	S.CER C1608 JB 1H 472K-T	T	113/27	
C304	4030017780	S.CER ECJ0EB1E472K	B	113.2/33.8	
C305	4030017780	S.CER ECJ0EB1E472K	T	114.9/12.6	
C306	4030017780	S.CER ECJ0EB1E472K	B	113.8/4.3	
C312	4030017780	S.CER ECJ0EB1E472K	T	108.2/29.6	
C315	4030017780	S.CER ECJ0EB1E472K	B	25.2/19.9	
C316	4030017780	S.CER ECJ0EB1E472K	B	26.1/19.9	
C317	4030017780	S.CER ECJ0EB1E472K	B	27/19.9	
C318	4030017780	S.CER ECJ0EB1E472K	B	23.9/19.8	
C319	4030017780	S.CER ECJ0EB1E472K	B	27.2/32.5	
C320	4030017780	S.CER ECJ0EB1E472K	B	26.3/32.5	
C321	4030017780	S.CER ECJ0EB1E472K	B	25.5/31.1	
C322	4030017780	S.CER ECJ0EB1E472K	T	24.6/27.3	
C501	4550007140	S.TAN TEESVD 1C 107M12R	B	53.3/20.9	
C502	4550007140	S.TAN TEESVD 1C 107M12R	B	45.3/20.9	
C513	4030016930	S.CER ECJ0EB1A104K	B	64.3/47.4	
C514	4030016930	S.CER ECJ0EB1A104K	B	63.3/47.4	
C515	4030017490	S.CER C1608 JB 1A 105K-T	B	61.5/44.9	
C516	4030018910	S.CER C1608 JB 0J 475K-T	B	67.7/48.9	
C517	4030017490	S.CER C1608 JB 1A 105K-T	B	75.6/47.9	
C518	4030017650	S.CER ECJ0EC1H270J	[EUR] [FRA] [ESP] [USA] [XPR] [ITR] [UK] [KOR] [AUS] [CHN]	B	73.4/47.4
C519	4030016930	S.CER ECJ0EB1A104K	B	76.9/48.4	
C520	4030016930	S.CER ECJ0EB1A104K	B	74.4/47.4	
C521	4030018960	S.CER C3216 JB 1C 106MT-N	B	65.6/20.6	
C522	4030016930	S.CER ECJ0EB1A104K	B	69.7/19.8	
C523	4030018970	S.CER C3225 JB 1C 226MT-N	B	53.4/28.9	
C524	4030017700	S.CER ECJ0EC1H151J	B	59/42.6	
C525	4030016930	S.CER ECJ0EB1A104K	B	55.4/30.3	
C526	4030018090	S.CER ECJ0EB1C822K	B	59.2/35.8	
C527	4030018100	S.CER ECJ0EB1H681K	B	59/45.9	
C528	4030017730	S.CER ECJ0EB1E471K	B	59/45	
C529	4030018970	S.CER C3225 JB 1C 226MT-N	B	58.4/40	
C530	4030016930	S.CER ECJ0EB1A104K	B	77.2/39.1	
C531	4030018970	S.CER C3225 JB 1C 226MT-N	B	81.3/35.9	
C532	4030016930	S.CER ECJ0EB1A104K	B	77.2/36.6	
C533	4030017490	S.CER C1608 JB 1A 105K-T	B	77/44.5	
C534	4030016970	S.CER ECJ0EB1C223K	B	77.5/42.5	
C536	4610001850	S.TRI TZB4R200AB10R00 (TZBX4R200BA110)	B	81/39.7	
C537	4030016930	S.CER ECJ0EB1A104K	B	77.2/40.1	
C538	4030016930	S.CER ECJ0EB1A104K	B	77.2/37.6	
C539	4030018910	S.CER C1608 JB 0J 475K-T	B	77.7/34.9	
C540	4030018910	S.CER C1608 JB 0J 475K-T	B	58.5/37	
C541	4030018970	S.CER C3225 JB 1C 226MT-N	B	59.2/28.9	
C542	4030018910	S.CER C1608 JB 0J 475K-T	B	77.7/33.6	
C543	4030018960	S.CER C3216 JB 1C 106MT-N	B	80/46.5	
C544	4030018910	S.CER C1608 JB 0J 475K-T	B	77.7/32.3	
C545	4030011600	S.CER C1608 JB 1E 104K-T	B	77/46.3	
C549	4030018960	S.CER C3216 JB 1C 106MT-N	B	71.7/28.8	
C550	4030018960	S.CER C3216 JB 1C 106MT-N	B	77/28.8	
C551	4030018960	S.CER C3216 JB 1C 106MT-N	B	73.8/28.8	
C559	4030017460	S.CER ECJ0EB1E102K	B	29.3/43.9	
C560	4030018960	S.CER C3216 JB 1C 106MT-N	B	17/33.2	
C561	4030017330	S.CER ECJ0EF1C104Z	B	7.3/30.7	
C562	4030017780	S.CER ECJ0EB1E472K	B	6.1/30.9	
C601	4030016930	S.CER ECJ0EB1A104K	B	73.6/24.9	
C602	4030016930	S.CER ECJ0EB1A104K	B	48.8/43.5	
C603	4030016930	S.CER ECJ0EB1A104K	B	55/39.4	
C604	4030018960	S.CER C3216 JB 1C 106MT-N	B	55.8/36.3	
C605	4030016930	S.CER ECJ0EB1A104K	B	50.9/48	
C606	4030018960	S.CER C3216 JB 1C 106MT-N	B	49/47.4	
C607	4030011600	S.CER C1608 JB 1E 104K-T	B	55.4/40.6	
C608	4030018960	S.CER C3216 JB 1C 106MT-N	B	55.8/43.7	
C609	4030011600	S.CER C1608 JB 1E 104K-T	B	50.6/31	

[DISPLAY UNIT]

REF NO.	PARTS NO.	DESCRIPTION	M.	H/V LOCATION
C654	4030017490	S.CER C1608 JB 1A 105K-T	B	3.5/20.4
C655	4030016790	S.CER ECJ0EB1C103K	B	8.0/30.3
C656	4030019090	S.CER C2012 JB 1C 225M-T	B	7.8/25.5
C657	4030018520	S.CER C1608 JB 0J 225M-T	B	7/20.6
C658	4030017650	S.CER ECJ0EC1H270J	B	5.5/20.5
C659	4030017780	S.CER ECJ0EB1E472K	B	15.2/20.3
C701	4030018960	S.CER C3216 JB 1C 106MT-N	B	4.6/32.4
C702	4030018960	S.CER C3216 JB 1C 106MT-N	B	48.9/19
C801	4030016930	S.CER ECJ0EB1A104K	B	62.9/19.7
C802	4030011600	S.CER C1608 JB 1E 104K-T	B	21.5/48.5
C851	4030017780	S.CER ECJ0EB1E472K	B	32.1/23.9
C852	4030018960	S.CER C3216 JB 1C 106MT-N	B	40.3/15.8
C853	4030016930	S.CER ECJ0EB1A104K	B	43.1/27.5
C2001	4030018520	S.CER C1608 JB 0J 225M-T	B	78.5/16.7
C2002	4030017780	S.CER ECJ0EB1E472K	T	114.8/34.7
C2003	4030017630	S.CER ECJ0EC1H120J	B	103.3/28.7
C2004	4030017630	S.CER ECJ0EC1H120J	B	103.3/25.1
C2005	4030016790	S.CER ECJ0EB1C103K	B	103.2/34.9
C2006	4030016930	S.CER ECJ0EB1A104K	B	98/37.9
C2007	4030018960	S.CER C3216 JB 1C 106MT-N	B	105.8/47.7
C2008	4030017030	S.CER ECJ0EB1A273K	B	109.7/44.6
C2009	4030016930	S.CER ECJ0EB1A104K	B	99/37.9
C2010	4030016930	S.CER ECJ0EB1A104K	B	100/37.9
C2011	4030016930	S.CER ECJ0EB1A104K	B	78.7/29.9
C2012	4030017780	S.CER ECJ0EB1E472K	B	95.8/37.9
C2013	4030017780	S.CER ECJ0EB1E472K	T	93/37.9
C2014	4030016930	S.CER ECJ0EB1A104K	T	110.4/41.7
C2015	4030016930	S.CER ECJ0EB1A104K	B	103.1/35.8
C2016	4030016930	S.CER ECJ0EB1A104K	B	82.7/28.4
J202	6510023801	S.CON S4B-ZR-SM4A-TF(LF)(SN)	B	115.9/39.4
J251	6510025770	S.CON 03-935H0-72BKA	B	154.2/45.8
J303	6510021431	S.CON S8B-ZR-SM4A-TF(LF)(SN)	B	115.9/20.9
J401	6510024840	S.CON 52746-1070	B	21.3/26.3
J601	6510024780	S.CON 52437-2472	B	45.1/42
J2001	6510024790	S.CON 52559-1072	B	96.9/47.6
DS805	5040003190	S.LED NSSW008B	T	29.5/39.4
DS806	5040003190	S.LED NSSW008B	T	29.4/31.4
DS807	5040003190	S.LED NSSW008B	T	29.4/24.1
DS808	5040003190	S.LED NSSW008B	T	29.5/16.1
DS2001	5040002930	S.LED SML-512MW T86	T	110.2/15.8
DS2002	5040002020	S.LED CL-170UR-CD-T 0	T	110.2/36.8
DS2004	5040002930	S.LED SML-512MW T86	T	11.4/20.5
S201	2230001160	S.SWI SPVP110100	T	157.4/34.3
S251	2220000330	S.SWI HSW0880-01-210	B	139.7/46.5
S701	2230001150	S.SWI LS9J2M-1FG-T	T	22.2/48.3
S702	2230001150	S.SWI LS9J2M-1FG-T	T	21.7/36.5
S703	2230001150	S.SWI LS9J2M-1FG-T	T	20.9/17
S704	2230001150	S.SWI LS9J2M-1FG-T	T	21.6/2.7
S721	2230001150	S.SWI LS9J2M-1FG-T	T	40.1/2.4
S722	2230001150	S.SWI LS9J2M-1FG-T	T	54.3/2.4
S723	2230001150	S.SWI LS9J2M-1FG-T	T	68.4/2.4
S724	2230001150	S.SWI LS9J2M-1FG-T	T	82.6/2.4
S741	2230001150	S.SWI LS9J2M-1FG-T	T	98.1/47.8
S742	2230001150	S.SWI LS9J2M-1FG-T	T	99.1/32.1
S743	2230001150	S.SWI LS9J2M-1FG-T	T	99.1/20.5
S744	2230001150	S.SWI LS9J2M-1FG-T	T	98.1/5.7
S761	2230001150	S.SWI LS9J2M-1FG-T	T	109.5/49.1
S762	2230001150	S.SWI LS9J2M-1FG-T	T	109.5/3.5
S763	2230001150	S.SWI LS9J2M-1FG-T	T	154.8/47.4
S764	2230001150	S.SWI LS9J2M-1FG-T	T	154.8/5.1
S781	2230001150	S.SWI LS9J2M-1FG-T	T	4.6/29
S782	2230001150	S.SWI LS9J2M-1FG-T	T	21.7/25.8
EP1	6910014730	S.BEA MPZ2012S331A-T	B	64.1/6.6

[VR UNIT]

REF NO.	PARTS NO.	DESCRIPTION	M.	H/V LOCATION
R1	7210003230	VAR TP96D00A-17F-10K BX2-2427		
R2	7030003860	S.RES ERJ3GE JPW V	T	1.3/32.6
R3	7030003860	S.RES ERJ3GE JPW V	T	2.3/30
J1	6510024850	S.CON 54550-1094	T	3.3/22.2
S1	2250000170	ENC TP90D96AE20-17F (1352)		
EP4	6910012350	S.BEA MMZ1608Y 102BT	T	2.7/32.6
EP5	6910012350	S.BEA MMZ1608Y 102BT	T	3.7/30
EP6	6910012350	S.BEA MMZ1608Y 102BT	T	.9/30
EP7	6910012350	S.BEA MMZ1608Y 102BT	T	.9/14.5
EP8	6910012350	S.BEA MMZ1608Y 102BT	T	3.7/14.5
EP9	6910012350	S.BEA MMZ1608Y 102BT	T	2.7/11.8
EP10	6910012350	S.BEA MMZ1608Y 102BT	T	2.3/14.5
EP11	6910012350	S.BEA MMZ1608Y 102BT	T	1.3/11.8

M.=Mounted side (T: Mounted on the Top side, B: Mounted on the Bottom side)
S.=Surface mount

[LOGIC UNIT]

REF NO.	PARTS NO.	DESCRIPTION	M.	H/V LOCATION
IC1	1130013281	S.IC TC58FVM6T5BTG65GCH (SX2427D-6)	T	27.9/30.2
IC2	1130011151	S.IC SN74AHC2G08HDCT3 0	B	40.2/38.2
IC3	1130011151	S.IC SN74AHC2G08HDCT3 0	B	40.6/32.4
IC4	1130012600	S.IC SN74AHC1G04DCKR	B	43.6/33.8
IC51	1130012842	S.IC CY7C1021DV33-10BVXIT	B	24.5/28.5
IC301	1140012541	S.IC ADSP-BF532SBBCZ400	B	28.6/39.2
IC401	1110004770	S.IC BU9480F-E2	B	17.4/21.6
IC451	1110006570	S.IC TS462CPT	B	29.1/7.9
IC452	1110006570	S.IC TS462CPT	T	39.1/8.5
IC502	1110006570	S.IC TS462CPT	T	30.7/5.4
IC551	1190001611	S.IC AK4528VFP-E2/P	T	17.9/8.1
IC601	1110006570	S.IC TS462CPT	B	12.7/10.8
IC701	1130012600	S.IC SN74AHC1G04DCKR	B	2.7/15.9
IC1201	1130012791	S.IC CY22150FZXCT	B	44.5/4.5
IC1212	1140012170	S.IC BH7236AF-E2	T	57.7/7.3
IC1217	1130007181	S.IC TC7WU04FU(TE12L,F)	B	63.4/9.8
IC1218	1130012761	S.IC SN74AHC2G86HDCT3 0	B	52.7/6.5
IC1226	1130010871	S.IC S1D13706F00A200	B	53.7/19.8
IC1251	1180002020	S.REG BA033FP-E2	T	79.5/5.2
IC1301	1130012691	S.IC R1EX24256ASA00A	T	81.4/36.2
IC1302	1140013137	S.IC HD6432375A23FQV(SX-2427B-7)	T	54.9/25.2
IC1303	1110005771	S.IC S-80942CNMC-G9C2G	T	81.2/10.4
IC1304	1130011551	S.IC RX-4581NB-F	B	71.9/7.2
IC1402	1130012781	S.IC SN74AHC2G04HDCT3 0	T	79.1/18.9
IC2002	1130012842	S.IC CY7C1021DV33-10BVXIT	B	32.7/28.3
IC2101	1130012850	S.IC SN74LVC3G34DCUR	T	44.5/44.7
IC2102	1130012850	S.IC SN74LVC3G34DCUR	T	44.4/41.2
IC2201	1140012541	S.IC ADSP-BF532SBBCZ400	B	28.6/17.7
Q201	1550000110	S.FET RTQ035P02TR	B	18.9/42.7
Q1101	1530002060	S.TRA 2SC4081 T106 R	T	82.1/20.3
Q1102	1590003940	S.TRA RN1105(TE85L,F)	T	81.8/22.7
Q1103	1510000510	S.TRA 2SA1576A T106R	T	81.8/16.4
Q1201	1590003940	S.TRA RN1105(TE85L,F)	T	44.8/13.2
D201	1750001280	S.DIO CUS02(TE85L,Q)	B	19.2/45.3
D1001	1750000370	S.DIO DA221 TL	B	64.5/36.8
D1002	1750000370	S.DIO DA221 TL	B	64.9/34.5
D1101	1790001250	S.DIO MA2S111-(TX)	T	81.9/18.4
D1106	1750000950	S.DIO MA732(TX)	T	80.1/29.6
D1107	1790001670	S.DIO RB706F-40T106	T	82.4/31.3
D1110	1790001670	S.DIO RB706F-40T106	T	75.7/32.3
D1111	1790001670	S.DIO RB706F-40T106	T	75.3/29.3
D1112	1790001670	S.DIO RB706F-40T106	B	79.2/29.1
D1113	1790001670	S.DIO RB706F-40T106	B	82.3/30.6
D1201	1790001250	S.DIO MA2S111-(TX)	B	83/40.4
D1301	1790000660	S.DIO MA728(TX)	B	77.5/2.9
D1304	1750000370	S.DIO DA221 TL	T	76.1/19.9
D1305	1750000370	S.DIO DA221 TL	T	75.8/16.8
D1306	1750000370	S.DIO DA221 TL	B	49.3/32.9
D1307	1750000370	S.DIO DA221 TL	B	51.4/33.3
D1311	1790001250	S.DIO MA2S111-(TX)	B	80.9/19.6
D1312	1790001250	S.DIO MA2S111-(TX)	B	83.1/18.5
D1313	1790001250	S.DIO MA2S111-(TX)	B	80/22.6
D1314	1790001240	S.DIO MA2S728-(TX)	B	81.7/22.4
D1331	1790001250	S.DIO MA2S111-(TX)	B	65.6/17.5
X1201	6050012150	S.XTA CR-806 SMD-49TA 4.433619 MHz [EUR]	B	61.3/3.1
	6050012150	S.XTA CR-806 SMD-49TA 4.433619 MHz [FRA]		
	6050012150	S.XTA CR-806 SMD-49TA 4.433619 MHz [ESP]		
	6050012140	S.XTA CR-805 SMD-49TA 3.579545 MHz [USA]		
	6050012150	S.XTA CR-806 SMD-49TA 4.433619 MHz [EXP]		
	6050012150	S.XTA CR-806 SMD-49TA 4.433619 MHz [ITR]		
	6050012150	S.XTA CR-806 SMD-49TA 4.433619 MHz [UK]		
	6050012140	S.XTA CR-805 SMD-49TA 3.579545 MHz [KOR]		
	6050012150	S.XTA CR-806 SMD-49TA 4.433619 MHz [AUS]		
	6050012150	S.XTA CR-806 SMD-49TA 4.433619 MHz [CHN]		
X1301	6050012190	S.XTA CR-809 SMD-49TA 1539744 MHz	B	60.4/30.8
L201	6200011900	S.COI LQH43CN100K03L	T	16/41.9
L202	6200009491	S.COI CDRH6D28NP-100NC	B	13.3/42.3
L551	6200005011	S.COI NLV25T-100J	T	11.2/10.5
L552	6200005011	S.COI NLV25T-100J	T	11.1/5.8
L1202	6200002041	S.COI NLV25T-101J	B	52.3/2.3
L1203	6200002041	S.COI NLV25T-101J	T	66.7/3.5
L1204	6200002041	S.COI NLV25T-101J	B	57.9/10.3
L2101	6200005011	S.COI NLV25T-100J	T	40.9/4.5
L2102	6200005011	S.COI NLV25T-100J	T	40.2/41.5
R2	7030005090	S.RES ERJ2GEJ 104 X (100K)	T	39.5/30.1
R3	7030005090	S.RES ERJ2GEJ 104 X (100K)	T	39.5/32.3
R4	7030005090	S.RES ERJ2GEJ 104 X (100K)	T	31.8/45.8
R5	7030005090	S.RES ERJ2GEJ 104 X (100K)	T	30.9/45.8

[LOGIC UNIT]

REF NO.	PARTS NO.	DESCRIPTION	M.	H/V LOCATION
R6	7030005090	S.RES ERJ2GEJ 104 X (100K)	T	30/45.8
R203	7030000010	S.RES MCR10EZHJ JPW (000)	T	20.7/45.6
R301	7030004980	S.RES ERJ2GEJ 101 X (100)	T	25.4/45.8
R302	7030005050	S.RES ERJ2GEJ 103 X (10K)	T	26.9/45.8
R303	7030005050	S.RES ERJ2GEJ 103 X (10K)	T	27.8/45.8
R306	7030005050	S.RES ERJ2GEJ 103 X (10K)	B	38.1/31.1
R307	7030005050	S.RES ERJ2GEJ 103 X (10K)	T	22/41.4
R308	7030005050	S.RES ERJ2GEJ 103 X (10K)	T	22/40.5
R310	7030005050	S.RES ERJ2GEJ 103 X (10K)	B	35.3/38
R312	7030010040	S.RES ERJ2GEJ-JPW	B	33.6/45.9
R313	7030010040	S.RES ERJ2GEJ-JPW	B	35.6/43.3
R314	7030010040	S.RES ERJ2GEJ-JPW	B	35.6/40.6
R413	7030004980	S.RES ERJ2GEJ 101 X (100)	B	18.1/16.8
R414	7030004980	S.RES ERJ2GEJ 101 X (100)	T	16.3/19.9
R415	7030004980	S.RES ERJ2GEJ 101 X (100)	B	19/16.8
R416	7030004980	S.RES ERJ2GEJ 101 X (100)	B	17.2/16.8
R462	7030004980	S.RES ERJ2GEJ 101 X (100)	B	33.8/7.4
R463	7030004980	S.RES ERJ2GEJ 101 X (100)	T	43.6/8.8
R464	7030004980	S.RES ERJ2GEJ 101 X (100)	B	26.2/5.7
R465	7030009270	S.RES ERJ2GEJ 821 X (820)	B	28.6/5.2
R467	7030004980	S.RES ERJ2GEJ 101 X (100)	B	31.3/4.3
R469	7030009270	S.RES ERJ2GEJ 821 X (820)	B	30.4/4.3
R470	7030009140	S.RES ERJ2GEJ 272 X (2.7K)	T	29/3.3
R471	7030009140	S.RES ERJ2GEJ 272 X (2.7K)	T	34/3.3
R472	7030005040	S.RES ERJ2GEJ 472 X (4.7K)	T	38.6/4.2
R473	7030005040	S.RES ERJ2GEJ 472 X (4.7K)	T	38.6/3.2
R474	7030009140	S.RES ERJ2GEJ 272 X (2.7K)	B	24.8/7.1
R475	7030009140	S.RES ERJ2GEJ 272 X (2.7K)	B	33.8/9.2
R476	7030005040	S.RES ERJ2GEJ 472 X (4.7K)	T	40.2/3.3
R507	7030004980	S.RES ERJ2GEJ 101 X (100)	T	26/3.5
R508	7030004980	S.RES ERJ2GEJ 101 X (100)	T	31.6/8.9
R510	7030005040	S.RES ERJ2GEJ 472 X (4.7K)	T	32.5/8.9
R511	7030005040	S.RES ERJ2GEJ 472 X (4.7K)	T	28.9/8.9
R512	7030004980	S.RES ERJ2GEJ 101 X (100)	T	29.8/8.9
R514	7030005050	S.RES ERJ2GEJ 103 X (10K)	T	34.9/8.8
R515	7030005050	S.RES ERJ2GEJ 103 X (10K)	T	34.9/7.9
R516	7030005040	S.RES ERJ2GEJ 472 X (4.7K)	T	39/12.8
R517	7030005040	S.RES ERJ2GEJ 472 X (4.7K)	T	36.5/11
R518	7030009140	S.RES ERJ2GEJ 272 X (2.7K)	T	36.4/5.6
R519	7030009140	S.RES ERJ2GEJ 272 X (2.7K)	T	26.4/5.6
R520	7030005040	S.RES ERJ2GEJ 472 X (4.7K)	T	41.3/12.8
R551	7030004980	S.RES ERJ2GEJ 101 X (100)	T	16.5/13.4
R553	7030004980	S.RES ERJ2GEJ 101 X (100)	T	14.7/13.4
R554	7030005090	S.RES ERJ2GEJ 104 X (100K)	T	15.4/3.2
R568	7030004980	S.RES ERJ2GEJ 101 X (100)	T	12.9/13.4
R569	7030004980	S.RES ERJ2GEJ 101 X (100)	T	15.6/13.4
R570	7030004980	S.RES ERJ2GEJ 101 X (100)	T	13.8/13.4
R571	7030009320	S.RES ERJ2GEJ 4R7 X (4.7)	B	20.7/8.4
R601	7030004980	S.RES ERJ2GEJ 101 X (100)	T	3/12.3
R602	7030007300	S.RES ERJ2GEJ 332 X (3.3K)	T	11.8/8.4
R603	7030005040	S.RES ERJ2GEJ 472 X (4.7K)	B	12.3/4.8
R604	7030005040	S.RES ERJ2GEJ 472 X (4.7K)	B	13.2/4.8
R605	7030007300	S.RES ERJ2GEJ 332 X (3.3K)	B	14.4/5.1
R606	7030007300	S.RES ERJ2GEJ 332 X (3.3K)	B	12.8/7.2
R607	7030005290	S.RES ERJ2GEJ 682 X (6.8K)	B	13.8/7.2
R608	7030005290	S.RES ERJ2GEJ 682 X (6.8K)	B	14.8/6.4
R609	7030005040	S.RES ERJ2GEJ 472 X (4.7K)	T	10.9/8.4
R610	7030005040	S.RES ERJ2GEJ 472 X (4.7K)	B	8.9/4.2
R611	7030005040	S.RES ERJ2GEJ 472 X (4.7K)	B	9.8/4.2
R612	7030007300	S.RES ERJ2GEJ 332 X (3.3K)	B	11.4/5.6
R613	7030007300	S.RES ERJ2GEJ 332 X (3.3K)	B	8.8/6.9
R614	7030005290	S.RES ERJ2GEJ 682 X (6.8K)	B	9.7/6.9
R615	7030005290	S.RES ERJ2GEJ 682 X (6.8K)	B	10.6/6.9
R618	7030005120	S.RES ERJ2GEJ 102 X (1K)	B	14.4/4.2
R619	7030005120	S.RES ERJ2GEJ 102 X (1K)	B	10.7/4.2
R701	7030005050	S.RES ERJ2GEJ 103 X (10K)	B	4.6/22.8
R702	7030005050	S.RES ERJ2GEJ 103 X (10K)	B	4.6/23.7
R703	7030005050	S.RES ERJ2GEJ 103 X (10K)	B	4.5/25.9
R705	7030005120	S.RES ERJ2GEJ 102 X (1K)	B	5/21
R706	7030005050	S.RES ERJ2GEJ 103 X (10K)	B	4.4/17.1
R707	7030007250	S.RES ERJ2GEJ 220 X (22)	B	4.4/15.5
R1001	7030005120	S.RES ERJ2GEJ 102 X (1K)	B	70.8/37
R1002	7030005050	S.RES ERJ2GEJ 103 X (10K)	B	65.9/32.3
R1003	7030005160	S.RES ERJ2GEJ 105 X (1M)	B	70.4/35.8
R1004	7030005240	S.RES ERJ2GEJ 473 X (47K)	B	66.1/18.5
R1006	7030005120	S.RES ERJ2GEJ 102 X (1K)	B	52/34.8
R1007	7030005120	S.RES ERJ2GEJ 102 X (1K)	B	53.2/32
R1008	7030005120	S.RES ERJ2GEJ 102 X (1K)	B	75.1/20.4
R1010	7030005240	S.RES ERJ2GEJ 473 X (47K)	B	76.7/19.8
R1012	7030005000	S.RES ERJ2GEJ 471 X (470)	B	66.5/33.9
R1013	7030005000	S.RES ERJ2GEJ 471 X (470)	B	66.5/36.4
R1015	7030005240	S.RES ERJ2GEJ 473 X (47K)	B	50.4/34.8
R1016	7030005240	S.RES ERJ2GEJ 473 X (47K)	B	51/31.7
R1018	7030007340	S.RES ERJ2GEJ 153 X (15K)	B	63.3/34.4
R1019	7030007340	S.RES ERJ2GEJ 153 X (15K)	B	62.9/36.1
R1101	7030008290	S.RES ERJ2GEJ 183 X (18K)	T	80.1/15.4
R1102	7030008010	S.RES ERJ2GEJ 123 X (12K)	T	79.9/21.9
R1103	7030005120	S.RES ERJ2GEJ 102 X (1K)	T	79.9/22.8
R1104	7030005120	S.RES ERJ2GEJ		

[LOGIC UNIT]

REF NO.	PARTS NO.	DESCRIPTION	M.	H/V LOCATION
R1116	7030005120	S.RES ERJ2GEJ 102 X (1K)	T	76.9/28.1
R1117	7030005120	S.RES ERJ2GEJ 102 X (1K)	B	82.7/22.2
R1118	7030007300	S.RES ERJ2GEJ 332 X (3.3K)	B	83/23.8
R1119	7030007300	S.RES ERJ2GEJ 332 X (3.3K)	B	83.8/22.2
R1120	7030005120	S.RES ERJ2GEJ 102 X (1K)	B	84.1/23.8
R1123	7030005160	S.RES ERJ2GEJ 105 X (1M)	B	66.9/24.4
R1124	7030005120	S.RES ERJ2GEJ 102 X (1K)	B	82/20
R1126	7030005160	S.RES ERJ2GEJ 105 X (1M)	B	66.9/23.5
R1127	7030010040	S.RES ERJ2GEJ-JPW	T	73.7/18.5
R1128	7030005120	S.RES ERJ2GEJ 102 X (1K)	B	83.2/20.1
R1129	7030007300	S.RES ERJ2GEJ 332 X (3.3K)	B	81.9/28.4
R1131	7030005090	S.RES ERJ2GEJ 104 X (100K)	B	78.5/26.1
R1132	7030005090	S.RES ERJ2GEJ 104 X (100K)	B	81.4/24.4
R1201	7030005160	S.RES ERJ2GEJ 105 X (1M)	B	62.7/7.6
R1202	7030005050	S.RES ERJ2GEJ 103 X (10K)	B	49.2/7.5
R1203	7030005050	S.RES ERJ2GEJ 103 X (10K)	B	49.2/8.4
R1204	7030005050	S.RES ERJ2GEJ 103 X (10K)	B	49.7/9.6
R1205	7030010040	S.RES ERJ2GEJ-JPW	B	49.2/3.1
R1206	7030007570	S.RES ERJ2GEJ 122 X (1.2K)	B	46.1/9.6
R1207	7030007570	S.RES ERJ2GEJ 122 X (1.2K)	B	43.9/9.6
R1208	7030007570	S.RES ERJ2GEJ 122 X (1.2K)	B	43.5/11.4
R1209	7030009710	S.RES ERJ2GEJ 203 X (20K)	B	48.8/9.6
R1210	7030007350	S.RES ERJ2GEJ 393 X (39K)	B	47.9/9.6
R1211	7030005050	S.RES ERJ2GEJ 103 X (10K)	B	48.9/11.4
R1212	7030005050	S.RES ERJ2GEJ 103 X (10K)	B	48/11.4
R1213	7030005050	S.RES ERJ2GEJ 103 X (10K)	B	47.1/11.4
R1214	7030009710	S.RES ERJ2GEJ 203 X (20K)	B	46.2/11.4
R1215	7030007350	S.RES ERJ2GEJ 393 X (39K)	B	45.3/11.4
R1216	7030005050	S.RES ERJ2GEJ 103 X (10K)	B	44.7/12.6
R1217	7030005050	S.RES ERJ2GEJ 103 X (10K)	B	44.7/13.5
R1218	7030005050	S.RES ERJ2GEJ 103 X (10K)	B	44.7/14.4
R1219	7030005040	S.RES ERJ2GEJ 472 X (4.7K)	B	74.4/41.1
R1220	7030009710	S.RES ERJ2GEJ 203 X (20K)	B	44.7/15.3
R1221	7030005040	S.RES ERJ2GEJ 472 X (4.7K)	B	79.9/41.6
R1222	7030005040	S.RES ERJ2GEJ 472 X (4.7K)	B	82.4/40.2
R1223	7030005040	S.RES ERJ2GEJ 472 X (4.7K)	B	74.4/39.3
R1224	7030005040	S.RES ERJ2GEJ 472 X (4.7K)	B	82.9/39.3
R1225	7030005240	S.RES ERJ2GEJ 473 X (47K)	B	83.1/35.7
R1226	7030005240	S.RES ERJ2GEJ 473 X (47K)	B	74.4/37.5
R1227	7030005240	S.RES ERJ2GEJ 473 X (47K)	B	73.8/38.4
R1228	7030005240	S.RES ERJ2GEJ 473 X (47K)	B	82.2/35.7
R1229	7030007350	S.RES ERJ2GEJ 393 X (39K)	B	43.5/15.4
R1230	7030004970	S.RES ERJ2GEJ 470 X (47K)	B	49.2/2.2
R1231	7030005050	S.RES ERJ2GEJ 103 X (10K)	B	48.8/5.4
R1232	7030005220	S.RES ERJ2GEJ 223 X (22K)	B	40.3/3.2
R1235	7030007270	S.RES ERJ2GEJ 151 X (150)	T	66.2/5.9
R1236	7030007270	S.RES ERJ2GEJ 151 X (150)	T	66.2/7
R1237	7030007290	S.RES ERJ2GEJ 222 X (2.2K)	B	61.1/7.6
R1251	7030011250	S.RES ERJ1TY 390U (39)	T	70.3/6.4
R1301	7030005220	S.RES ERJ2GEJ 223 X (22K)	T	78.1/37.8
R1302	7030005050	S.RES ERJ2GEJ 103 X (10K)	T	78.1/36
R1303	7030005240	S.RES ERJ2GEJ 473 X (47K)	B	66/21.2
R1304	7030005240	S.RES ERJ2GEJ 473 X (47K)	B	66/20.3
R1305	7030009160	S.RES ERJ2GEJ 181 X (180)	T	68.5/25.9
R1306	7030005060	S.RES ERJ2GEJ 333 X (33K)	T	78.7/11.4
R1307	7030005040	S.RES ERJ2GEJ 472 X (4.7K)	B	68/21.9
R1308	7030005110	S.RES ERJ2GEJ 224 X (220K)	T	67.5/20
R1309	7030005110	S.RES ERJ2GEJ 224 X (220K)	T	69/19.4
R1310	7030005110	S.RES ERJ2GEJ 224 X (220K)	T	67.5/18.8
R1311	7030005110	S.RES ERJ2GEJ 224 X (220K)	T	69/18.2
R1312	7030005110	S.RES ERJ2GEJ 224 X (220K)	T	67.5/17.6
R1313	7030005110	S.RES ERJ2GEJ 224 X (220K)	T	69/17
R1314	7030005110	S.RES ERJ2GEJ 224 X (220K)	T	67.5/16.4
R1315	7030005110	S.RES ERJ2GEJ 224 X (220K)	T	69/15.8
R1316	7030005110	S.RES ERJ2GEJ 224 X (220K)	B	66.6/12.3
R1317	7030005110	S.RES ERJ2GEJ 224 X (220K)	B	65.7/12.3
R1318	7030005110	S.RES ERJ2GEJ 224 X (220K)	B	64.8/12.3
R1319	7030005110	S.RES ERJ2GEJ 224 X (220K)	B	63.9/12.3
R1320	7030005110	S.RES ERJ2GEJ 224 X (220K)	B	63/12.3
R1321	7030005110	S.RES ERJ2GEJ 224 X (220K)	B	62.1/12.3
R1322	7030005110	S.RES ERJ2GEJ 224 X (220K)	B	61.2/12.3
R1323	7030005110	S.RES ERJ2GEJ 224 X (220K)	B	60.3/12.1
R1324	7030005050	S.RES ERJ2GEJ 103 X (10K)	T	80.5/12.6
R1325	7030007350	S.RES ERJ2GEJ 393 X (39K)	T	78.1/9.8
R1326	7030005010	S.RES ERJ2GEJ 681 X (680)	B	78.9/2
R1327	7030005240	S.RES ERJ2GEJ 473 X (47K)	B	66/19.4
R1328	7030005050	S.RES ERJ2GEJ 103 X (10K)	B	75.9/6.4
R1329	7030005240	S.RES ERJ2GEJ 473 X (47K)	B	75.9/5
R1331	7030010040	S.RES ERJ2GEJ-JPW	B	75.9/3.2
R1332	7030005040	S.RES ERJ2GEJ 472 X (4.7K)	B	75.9/4.1
R1333	7030005110	S.RES ERJ2GEJ 224 X (220K)	B	67.4/26.9
R1334	7030005050	S.RES ERJ2GEJ 103 X (10K)	T	78.3/12.6
R1335	7030010040	S.RES ERJ2GEJ-JPW	T	78.5/5.1
R1337	7030005240	S.RES ERJ2GEJ 473 X (47K)	B	40.9/15.5
R1338	7030005240	S.RES ERJ2GEJ 473 X (47K)	T	40.9/16.4
R1339	7030007290	S.RES ERJ2GEJ 222 X (2.2K)	B	65.5/22.4
R1401	7030005240	S.RES ERJ2GEJ 473 X (47K)	B	62.7/24.2
R1402	7030005240	S.RES ERJ2GEJ 473 X (47K)	B	76.7/21.8
R1403	7030005240	S.RES ERJ2GEJ 473 X (47K)	B	78.3/22.1
R1404	7030005240	S.RES ERJ2GEJ 473 X (47K)	B	76.7/22.9
R1405	7030005240	S.RES ERJ2GEJ 473 X (47K)	T	50.7/12.9
R1406	7030005240	S.RES ERJ2GEJ 473 X (47K)	T	69/20.6
R1407	7030005240	S.RES ERJ2GEJ 473 X (47K)	T	41.7/33.4
R1408	7030005240	S.RES ERJ2GEJ 473 X (47K)	B	76.7/25.3
R1409	7030005240	S.RES ERJ2GEJ 473 X (47K)	B	78.3/24.7
R1410	7030005240	S.RES ERJ2GEJ 473 X (47K)	B	78.3/23.5
R1411	7030005240	S.RES ERJ2GEJ 473 X (47K)	B	76.7/24.1
R1412	7030005240	S.RES ERJ2GEJ 473 X (47K)	B	43.6/24.7
R1413	7030005240	S.RES ERJ2GEJ 473 X (47K)	T	42.4/17.9

[LOGIC UNIT]

REF NO.	PARTS NO.	DESCRIPTION	M.	H/V LOCATION
R1502	7030007300	S.RES ERJ2GEJ 332 X (3.3K)	B	80.9/28.4
R2101	7030005050	S.RES ERJ2GEJ 103 X (10K)	T	48.1/44.9
R2102	7030005050	S.RES ERJ2GEJ 103 X (10K)	T	47.7/42.7
R2103	7030005050	S.RES ERJ2GEJ 103 X (10K)	T	47.6/40.5
R2104	7030005050	S.RES ERJ2GEJ 103 X (10K)	T	47.7/43.7
R2105	7030005050	S.RES ERJ2GEJ 103 X (10K)	T	47.5/41.7
R2110	7030010040	S.RES ERJ2GEJ-JPW	B	21.4/22.5
R2112	7030005040	S.RES ERJ2GEJ 472 X (4.7K)	T	38.5/44.4
R2201	7030004980	S.RES ERJ2GEJ 101 X (100)	T	31.5/11.1
R2202	7030005050	S.RES ERJ2GEJ 103 X (10K)	T	30.6/11.1
R2203	7030005050	S.RES ERJ2GEJ 103 X (10K)	T	21.5/22.4
R2204	7030005050	S.RES ERJ2GEJ 103 X (10K)	T	35.2/15.5
R2205	7030005050	S.RES ERJ2GEJ 103 X (10K)	T	35.2/16.4
R2206	7030005050	S.RES ERJ2GEJ 103 X (10K)	T	21.5/21.5
R2214	7030005050	S.RES ERJ2GEJ 103 X (10K)	T	27.5/11.1
R2215	7030005050	S.RES ERJ2GEJ 103 X (10K)	T	28.4/11.1
R2216	7030010040	S.RES ERJ2GEJ-JPW	T	34.8/37.3
C1	4030016930	S.CER ECJ0EB1A104K	T	16.9/25.1
C2	4030016930	S.CER ECJ0EB1A104K	B	38.1/36
C3	4030016930	S.CER ECJ0EB1A104K	B	39.5/28.9
C4	4030016930	S.CER ECJ0EB1A104K	B	42.4/35.8
C5	4550007310	S.TAN F930J227MNMBSMA	T	40.8/23.4
C51	4030016930	S.CER ECJ0EB1A104K	B	19.2/27.4
C52	4030016930	S.CER ECJ0EB1A104K	B	19.2/28.3
C53	4550007310	S.TAN F930J227MNMBSMA	B	11.4/30.3
C54	4550007310	S.TAN F930J227MNMBSMA	T	7.1/8
C201	4030016930	S.CER ECJ0EB1A104K	B	19.4/20.2
C203	4030018960	S.CER C3216 JB 1C 106MT-N	T	18.8/45.5
C204	4030016930	S.CER ECJ0EB1A104K	T	11.9/40.2
C205	4030016930	S.CER ECJ0EB1A104K	T	11.9/41.8
C206	4030016930	S.CER ECJ0EB1A104K	B	8.8/43.4
C207	4030019460	S.CER C1608 JB 0J 106M-T	T	9.9/45
C302	4030016930	S.CER ECJ0EB1A104K	T	30.2/40.4
C303	4030016930	S.CER ECJ0EB1A104K	T	30.4/37.8
C304	4030016930	S.CER ECJ0EB1A104K	T	26.9/37.2
C305	4030016930	S.CER ECJ0EB1A104K	T	34.1/45.8
C306	4030016930	S.CER ECJ0EB1A104K	T	29.2/37.2
C307	4030016930	S.CER ECJ0EB1A104K	B	38.3/35
C308	4030016930	S.CER ECJ0EB1A104K	T	27.3/39.3
C309	4030016930	S.CER ECJ0EB1A104K	T	30.6/39.1
C310	4030016930	S.CER ECJ0EB1A104K	T	24.5/45.8
C311	4030016930	S.CER ECJ0EB1A104K	T	22/42.3
C312	4030016930	S.CER ECJ0EB1A104K	T	27.8/40.5
C313	4030016930	S.CER ECJ0EB1A104K	T	22/39.6
C314	4030016930	S.CER ECJ0EB1A104K	T	29.1/45.8
C315	4030016930	S.CER ECJ0EB1A104K	T	27.3/38.4
C316	4030016930	S.CER ECJ0EB1A104K	T	30.4/36.9
C317	4030016930	S.CER ECJ0EB1A104K	T	26.9/40.5
C318	4030016930	S.CER ECJ0EB1A104K	T	31.1/40.4
C319	4030016930	S.CER ECJ0EB1A104K	T	29.3/40.4
C320	4030016930	S.CER ECJ0EB1A104K	T	27.8/37.2
C413	4030018960	S.CER C3216 JB 1C 106MT-N	B	21.3/19.6
C414	4030016930	S.CER ECJ0EB1A104K	B	16.3/16.8
C415	4030018960	S.CER C3216 JB 1C 106MT-N	B	15.6/26.3
C461	4030016930	S.CER ECJ0EB1A104K	B	34.2/4.3
C462	4030018960	S.CER C3216 JB 1C 106MT-N	B	35.3/5.8
C463	4030018960	S.CER C3216 JB 1C 106MT-N	T	42/8.7
C464	4030016930	S.CER ECJ0EB1A104K	T	43.6/10.4
C465	4030017740	S.CER ECJ0EB1E821K	B	27.4/5.5
C466	4030017760	S.CER ECJ0EB1H222K	B	29.5/4.3
C467	4030017740	S.CER ECJ0EB1E821K	B	30.7/5.5
C468	4030018560	S.CER C2012 JB 1A 475K-T	T	31.8/2.6
C469	4030016930	S.CER ECJ0EB1A104K	B	24.8/8.7
C470	4030016930	S.CER ECJ0EB1A104K	B	33.8/8.3
C471	4030018560	S.CER C2012 JB 1A 475K-T	T	36.2/4.2
C472	4030018560	S.CER C2012 JB 1A 475K-T	T	36.2/2.5
C473	4030016930	S.CER ECJ0EB1A104K	T	40.2/4.2
C509	4030018960	S.CER C3216 JB 1C 106MT-N	T	24.2/5.5
C510	4030016930	S.CER ECJ0EB1A104K	T	26/4.4
C511	4030017760	S.CER ECJ0EB1H222K	T	30.7/8.9
C512	4030017690	S.CER ECJ0EC1H121J	T	32.1/7.7
C513	4030017690	S.CER ECJ0EC1H121J	T	29.4/7.7
C514	4030016930	S.CER ECJ0EB1A104K	T	36.4/5.5
C515	4030018860	S.CER ECJ0EB0J105K	T	36.5/9.2
C516	4030018860	S.CER ECJ0EB0J105K	T	36.5/8.3
C517	4030018860	S.CER ECJ0EB0J105K	T	36.5/10.1
C518	4030016930	S.CER ECJ0EB1A104K	T	26.1/6.8
C519	4030016930	S.CER ECJ0EB1A104K	T	41.3/11.9
C522	4030017780	S.CER ECJ0EB1E472K	B	38.9/9.8
C523	4030017780	S.CER ECJ0EB1E472K	B	38/2.8
C524	4030017780	S.CER ECJ0EB1E472K	T	3.8/2.6
C525	4030017780	S.CER ECJ0EB1E472K	T	22.4/2.7
C526	4030017780	S.CER ECJ0EB1E472K	T	42.9/3.8
C527	4030017780	S.CER ECJ0EB1E472K	B	

[LOGIC UNIT]

REF NO.	PARTS NO.	DESCRIPTION	M.	H/V LOCATION
C606	4030018580	S.CER C1608 CH 1H 821J-T	B	9.6/5.6
C607	4030017440	S.CER ECJ0EC1H221J	B	13.3/8.4
C608	4030017440	S.CER ECJ0EC1H221J	B	14.8/8
C609	4030018860	S.CER ECJ0EB0J105K	B	15.8/14.5
C610	4030010760	S.CER C1608 CH 1H 331J-T	B	9.6/8.3
C611	4030010760	S.CER C1608 CH 1H 331J-T	B	11.8/7.7
C612	4030018960	S.CER C3216 JB 1C 106MT-N	B	7.5/13.1
C613	4550006780	S.TAN TEESVB2 0J 476M8R	B	20.6/2.7
C614	4550006780	S.TAN TEESVB2 0J 476M8R	T	3.1/6.6
C651	4030017460	S.CER ECJ0EB1E102K	B	65.5/31.4
C652	4030017460	S.CER ECJ0EB1E102K	B	66/16.4
C653	4030017460	S.CER ECJ0EB1E102K	B	77.1/20.9
C654	4030017430	S.CER ECJ0EC1H101J	B	77.2/28.2
C655	4030017430	S.CER ECJ0EC1H101J	B	76.5/27.1
C656	4030017430	S.CER ECJ0EC1H101J	B	76.1/26.2
C701	4030016930	S.CER ECJ0EB1A104K	B	3/13.5
C702	4030017780	S.CER ECJ0EB1E472K	B	4.4/18.8
C703	4030017780	S.CER ECJ0EB1E472K	B	7.5/26.1
C704	4030017780	S.CER ECJ0EB1E472K	B	19.7/26.2
C705	4030017430	S.CER ECJ0EC1H101J	B	4.6/21.9
C706	4030017430	S.CER ECJ0EC1H101J	B	4.6/24.6
C707	4030017430	S.CER ECJ0EC1H101J	B	3.9/27.2
C708	4030017430	S.CER ECJ0EC1H101J	B	6.6/26.1
C709	4030017430	S.CER ECJ0EC1H101J	T	2.5/20.1
C711	4550007310	S.TAN F930J227MNMBA	T	5.5/18.9
C715	4030017460	S.CER ECJ0EB1E102K	T	2.2/17.6
C716	4030017460	S.CER ECJ0EB1E102K	T	2.2/18.6
C717	4030017460	S.CER ECJ0EB1E102K	T	2.2/16.6
C1001	4030017780	S.CER ECJ0EB1E472K	B	76.7/18.9
C1002	4030017780	S.CER ECJ0EB1E472K	B	70.4/38.2
C1101	4030017780	S.CER ECJ0EB1E472K	T	79.9/23.7
C1102	4030017780	S.CER ECJ0EB1E472K	T	73.6/20.7
C1103	4030016930	S.CER ECJ0EB1A104K	T	81.8/14.5
C1106	4030017780	S.CER ECJ0EB1E472K	T	79.7/31.9
C1107	4030018900	S.CER ECJ0EB0J474K	B	80.1/25.5
C1108	4030018900	S.CER ECJ0EB0J474K	B	81.4/25.4
C1109	4030017780	S.CER ECJ0EB1E472K	T	79.7/26.3
C1110	4030017780	S.CER ECJ0EB1E472K	T	80.7/26.3
C1111	4030017780	S.CER ECJ0EB1E472K	T	81.7/26.3
C1112	4030017780	S.CER ECJ0EB1E472K	B	82.9/28.4
C1201	4030016930	S.CER ECJ0EB1A104K	B	50.6/4.3
C1202	4030017780	S.CER ECJ0EB1E472K	B	53.2/4.3
C1203	4030017650	S.CER ECJ0EC1H270J	B	62.7/6.7
C1204	4030016930	S.CER ECJ0EB1A104K	B	47.9/8
C1205	4030016930	S.CER ECJ0EB1A104K	B	45.2/9.6
C1206	4030016930	S.CER ECJ0EB1A104K	B	43.5/13.8
C1207	4030017430	S.CER ECJ0EC1H101J	B	47/9.6
C1208	4030017430	S.CER ECJ0EC1H101J	B	43.9/8.7
C1209	4030017430	S.CER ECJ0EC1H101J	B	44.4/11.4
C1210	4030017650	S.CER ECJ0EC1H270J	B	61.1/6.7
C1211	4030018860	S.CER ECJ0EB0J105K	B	60.2/10.5
C1212	4030016930	S.CER ECJ0EB1A104K	B	49.7/4.3
C1213	4030016930	S.CER ECJ0EB1A104K	B	49.2/6.6
C1214	4030016930	S.CER ECJ0EB1A104K	B	40.3/4.8
C1215	4030016930	S.CER ECJ0EB1A104K	B	64.2/19.3
C1216	4030016930	S.CER ECJ0EB1A104K	B	53.7/30.3
C1217	4030016930	S.CER ECJ0EB1A104K	B	57.5/29.2
C1218	4030016930	S.CER ECJ0EB1A104K	B	44.8/23.9
C1219	4030016930	S.CER ECJ0EB1A104K	B	46.3/13.2
C1220	4030016930	S.CER ECJ0EB1A104K	B	56/8.8
C1221	4030016930	S.CER ECJ0EB1A104K	B	60.5/13.7
C1222	4030016930	S.CER ECJ0EB1A104K	B	60.9/25.6
C1223	4030016930	S.CER ECJ0EB1A104K	T	52.7/12.3
C1225	4030018960	S.CER C3216 JB 1C 106MT-N	T	66.7/10.2
C1251	4030012610	S.CER C2012 JB 1C 474K-T	T	73.4/9.3
C1252	4550007320	S.TAN F930J226MAABMA	T	73.4/4.4
C1301	4030016930	S.CER ECJ0EB1A104K	T	80.1/40.3
C1302	4030018960	S.CER C3216 JB 1C 106MT-N	T	47.9/11.4
C1303	4030016790	S.CER ECJ0EB1C103K	T	67.9/30.4
C1304	4030016930	S.CER ECJ0EB1A104K	T	41.7/31.5
C1305	4030018960	S.CER C3216 JB 1C 106MT-N	T	44.3/37.2
C1306	4030016790	S.CER ECJ0EB1C103K	T	64/37.5
C1307	4030016930	S.CER ECJ0EB1A104K	T	48.4/12.9
C1308	4030016930	S.CER ECJ0EB1A104K	T	63.1/13.1
C1309	4030016930	S.CER ECJ0EB1A104K	T	46.1/37.2
C1310	4030016930	S.CER ECJ0EB1A104K	T	67/30.9
C1311	4030016930	S.CER ECJ0EB1A104K	T	67/25.7
C1312	4030017620	S.CER ECJ0EC1H100C	T	67.4/29.1
C1313	4030017620	S.CER ECJ0EC1H100C	T	67.4/28.2
C1314	4030016930	S.CER ECJ0EB1A104K	T	79/9.8
C1315	4030017030	S.CER ECJ0EB1A273K	T	83.3/10.8
C1316	4030016930	S.CER ECJ0EB1A104K	B	75.9/2.3
C1317	4030018960	S.CER C3216 JB 1C 106MT-N	B	84.4/3
C1319	4030018960	S.CER C3216 JB 1C 106MT-N	B	16.8/6.6
C2016	4030016930	S.CER ECJ0EB1A104K	B	37.7/29.3
C2017	4030016930	S.CER ECJ0EB1A104K	B	37.7/30.2
C2101	4030016930	S.CER ECJ0EB1A104K	T	44/43
C2102	4030016930	S.CER ECJ0EB1A104K	T	45.8/43
C2202	4030016930	S.CER ECJ0EB1A104K	T	27/16.5
C2204	4030016930	S.CER ECJ0EB1A104K	T	26.5/19.2
C2205	4030016930	S.CER ECJ0EB1A104K	T	30.2/19.7
C2206	4030016930	S.CER ECJ0EB1A104K	T	26.6/11.1
C2207	4030016930	S.CER ECJ0EB1A104K	T	27.7/19.7
C2208	4030016930	S.CER ECJ0EB1A104K	T	21.5/23.4
C2209	4030016930	S.CER ECJ0EB1A104K	T	29.8/17.6
C2210	4030016930	S.CER ECJ0EB1A104K	T	26.6/17.8
C2211	4030016930	S.CER ECJ0EB1A104K	T	32.4/11.1
C2212	4030016930	S.CER ECJ0EB1A104K	T	35.2/14.6
C2213	4030016930	S.CER ECJ0EB1A104K	T	29.3/16.4

[LOGIC UNIT]

REF NO.	PARTS NO.	DESCRIPTION	M.	H/V LOCATION
C2214	4030016930	S.CER ECJ0EB1A104K	T	35.2/17.3
C2215	4030016930	S.CER ECJ0EB1A104K	T	29.3/11.1
C2217	4030016930	S.CER ECJ0EB1A104K	T	29.8/18.5
C2218	4030016930	S.CER ECJ0EB1A104K	T	26.5/20.1
C2219	4030016930	S.CER ECJ0EB1A104K	T	30.2/16.4
C2220	4030016930	S.CER ECJ0EB1A104K	T	26.1/16.5
C2221	4030016930	S.CER ECJ0EB1A104K	T	27.9/16.5
C2222	4030016930	S.CER ECJ0EB1A104K	T	29.3/19.7
J651	6510024810	S.CON AXK6S60635P 2	B	71/24.9
J701	6510022070	S.CON AXK6S30635P 2	B	10.9/20.4
J1201	6510018891	S.CON 52559-1370(1390)	B	77.5/38.2
J2101	6510020130	S.CON AXN810535P	T	52.4/42.9
BT1301	3020000330	LIT ML920S/F9D		
EP2	6910012350	S.BEA MMZ1608Y 102BT	T	18.8/38.2
EP51	6910012350	S.BEA MMZ1608Y 102BT	B	18.1/29.7
EP201	6910014730	S.BEA MPZ2012S331A-T	T	13.3/40.6
EP301	6910012350	S.BEA MMZ1608Y 102BT	T	19.1/40
EP701	6910012350	S.BEA MMZ1608Y 102BT	B	5.6/15.3
EP2002	6910012350	S.BEA MMZ1608Y 102BT	B	38.2/27.6
EP2202	6910012350	S.BEA MMZ1608Y 102BT	T	19.1/22
EP2205	6910014730	S.BEA MPZ2012S331A-T	T	18.4/17.7
EP2217	6910015970	S.BEA MMZ1608B 301CT-AS	B	20.9/16.1

[CONNECT UNIT]

REF NO.	PARTS NO.	DESCRIPTION	M.	H/V LOCATION
J1	6510019971	S.CON 52808-1071	T	7.1/11.8
W1	8900016410	CAB OPC-1579A		

M.=Mounted side (T: Mounted on the Top side, B: Mounted on the Bottom side)
S.=Surface mount

[DDS UNIT]

REF NO.	PARTS NO.	DESCRIPTION	M.	H/V LOCATION
IC51	1190001811	S.IC AD9833BRMZ	T	38.7/3.5
IC52	1130012781	S.IC SN74AHC2G04HDC3 0	T	45/5.6
IC61	1130012610	S.IC SN74AHC1GU04DCKR	T	37.5/7.5
IC62	1130012850	S.IC SN74LVC3G34DCUR	T	51.3/24.7
IC251	1180002321	S.REG TK11218CMCL-G	B	29.5/16.2
IC301	1190002101	S.IC AD9951Y28Z	T	37.5/28.2
IC401	1110004080	S.IC UPC2709T-E3	T	50.1/47
IC451	1110006430	S.IC UPC1678GV-E1-A	T	34.1/50.2
IC801	1110006430	S.IC UPC1678GV-E1-A	T	18/13.7
IC901	1130012720	S.IC CD74HC4094PWR	T	5.4/64.7
Q1	1530002381	S.TRA 2SC4215-Y(TE85L,F)	T	20.4/3.1
Q101	1530002561	S.TRA 2SC4403-3-TL-E	T	26.5/6.4
Q151	1530003151	S.TRA 2SC4673D-TD-E	T	41.4/13.7
Q201	1530003432	S.TRA 2SC5226A-4-TL-E	T	43.4/19.4
Q211	1530003432	S.TRA 2SC5226A-4-TL-E	B	43.5/15.2
Q301	1590000680	S.TRA DTC114EU T106	B	45.3/32.3
Q901	1590003930	S.TRA UMD22N TR	T	4/58.7
Q902	1590003930	S.TRA UMD22N TR	T	4.1/55.1
Q903	1590003930	S.TRA UMD22N TR	T	7.2/55.1
Q904	1590003930	S.TRA UMD22N TR	T	7.2/58.7
Q905	1590003930	S.TRA UMD22N TR	T	4.1/70.7
Q906	1590003930	S.TRA UMD22N TR	T	4.1/74.2
Q907	1590003930	S.TRA UMD22N TR	T	7.1/70.7
Q908	1590003930	S.TRA UMD22N TR	T	7.1/74.2
Q1101	1530002060	S.TRA 2SC4081 T106 R	T	40.9/53.9
Q1102	1540000451	S.TRA 2SD1623T-TD-E	T	45.5/54.3
D301	1750000620	S.DIO MA717WK(TX)	B	44.8/35.9
D341	1790001621	S.DIO 1SV308(TPL3,F)	B	45.2/39.7
D451	1750000581	S.DIO 1SV307(TPH3,F)	T	44.2/47.7
D452	1750000581	S.DIO 1SV307(TPH3,F)	T	44/44.8
D453	1790001621	S.DIO 1SV308(TPL3,F)	T	43.3/36.6
D454	1750000581	S.DIO 1SV307(TPH3,F)	T	38.3/48.3
D456	1750000620	S.DIO MA717WK(TX)	B	35.1/42.8
D458	1750000581	S.DIO 1SV307(TPH3,F)	T	33.8/45.6
D459	1750000581	S.DIO 1SV307(TPH3,F)	T	31.3/38.8
D471	1750000620	S.DIO MA717WK(TX)	T	33.2/36.6
D501	1750000581	S.DIO 1SV307(TPH3,F)	B	26.2/42.6
D502	1750000581	S.DIO 1SV307(TPH3,F)	T	3/50.6
D551	1750000581	S.DIO 1SV307(TPH3,F)	T	25.9/45.1
D552	1750000581	S.DIO 1SV307(TPH3,F)	T	2.9/45.3
D601	1750000581	S.DIO 1SV307(TPH3,F)	T	27.2/39.9
D602	1750000581	S.DIO 1SV307(TPH3,F)	T	2.9/40.1
D651	1750000581	S.DIO 1SV307(TPH3,F)	T	27.2/34.8
D652	1750000581	S.DIO 1SV307(TPH3,F)	T	2.9/34.9
D701	1750000581	S.DIO 1SV307(TPH3,F)	T	27.2/29.5
D702	1750000581	S.DIO 1SV307(TPH3,F)	T	2.9/29.7
D751	1750000581	S.DIO 1SV307(TPH3,F)	T	27/24.4
D752	1750000581	S.DIO 1SV307(TPH3,F)	T	2.9/24.6
D801	1750000581	S.DIO 1SV307(TPH3,F)	T	28.3/21.6
D802	1750000581	S.DIO 1SV307(TPH3,F)	T	2.9/19.3
D1101	1750000301	S.DIO 1SS302(TE85R,F)	T	40.9/57.7
D1102	1160000080	S.DIO DAP202K T146	B	27.9/63
FI101	2010002660	S.XTA DSF334SAF 124.032 MHz(FL-391)	T	29.3/10.7
FI201	2040001860	S.SAW NSVS776	T	34.5/16.5
X1	6050012800	S.XTA CR-788B VC-TXCO 24.8064 MHz	T	13.8/3.7
L1	6200002641	S.COI NLV25T-R15J	T	26/3.7
L51	6200005011	S.COI NLV25T-100J	B	35.6/4.2
L52	6200005011	S.COI NLV25T-100J	B	38.8/3.8
L53	6200003241	S.COI NLV32T-221J	B	43.4/8.7
L54	6200009351	S.COI ELJRE R22GFA	T	34.6/8.6
L101	6200003540	S.COI MLF1608D R22K-T	T	24.2/8.8
L105	6200012650	S.COI MLF1608A 1R5J-T	T	23.7/5.2
L151	6200004470	S.COI MLF1608D R12K-T	T	44.7/12.8
L153	6200004150	S.COI MLF1608D 47NM-T	T	46.9/15.7
L201	6200004150	S.COI MLF1608D 47NM-T	T	44.5/21.5
L202	6200005661	S.COI ELJRE 10NGFA	B	37.5/12.4
L204	6200003540	S.COI MLF1608D R22K-T	T	41.5/19.3
L205	6200005711	S.COI ELJRE 27NGFA	B	47.1/21.7
L206	6200005701	S.COI ELJRE 22NGFA	B	46.2/20.4
L210	6200005701	S.COI ELJRE 22NGFA	B	47/19.1
L212	6200002581	S.COI NLV25T-033J	B	41.9/12.8
L213	6200005681	S.COI ELJRE 15NGFA	B	40.1/17.8
L301	6140002810	S.COI LR-317	T	48.5/30
L302	6140002810	S.COI LR-317	T	48.7/38.9
L303	6200004150	S.COI MLF1608D 47NM-T	B	41.9/35.7
L304	6200003960	S.COI MLF1608A 1R0K-T	T	50.4/33.2
	6200003960	S.COI MLF1608A 1R0K-T	[EUR]	
	6200003960	S.COI MLF1608A 1R0K-T	[FRA]	
	6200003960	S.COI MLF1608A 1R0K-T	[ESP]	
	6200003960	S.COI MLF1608A 1R0K-T	[USA]	
	6200003960	S.COI MLF1608A 1R0K-T	[EXP]	
	6200003960	S.COI MLF1608A 1R0K-T	[ITR]	
	6200003960	S.COI MLF1608A 1R0K-T	[UK]	
	6200003960	S.COI MLF1608A 1R0K-T	[KOR]	
	6200003960	S.COI MLF1608A 1R0K-T	[CHN]	
L321	6200009560	S.COI MLG1608B R10J-T	T	50.4/34.7
L322	6200011770	S.COI LQW18ANR10G00D	T	47.8/34.7
L323	6200005671	S.COI ELJRE 12NGFA	T	53.6/30.1
L331	6200009680	S.COI MLG1608B 47NJ-T	T	47.6/43.1
L332	6200009680	S.COI MLG1608B 47NJ-T	T	50.2/43.1

[DDS UNIT]

REF NO.	PARTS NO.	DESCRIPTION	M.	H/V LOCATION
L341	6200004470	S.COI MLF1608D R12K-T	B	41.1/37
L401	6200001981	S.COI NLV25T-1R0J	T	50.2/49.9
L411	6200009610	S.COI MLG1608B 39NJ-T	T	47.3/48.3
L456	6140002810	S.COI LR-317	T	40.1/44.9
L458	6200009680	S.COI MLG1608B 47NJ-T	B	37.5/42.1
L461	6200009660	S.COI MLG1608B 10NJ-T	B	39.3/41.7
L464	6200002631	S.COI NLV25T-R10J	T	28.8/50.6
L465	6200004470	S.COI MLF1608D R12K-T	T	42.9/39.5
L466	6200011580	S.COI LQW18AN33NG00D	T	39.1/41.1
L467	6200009670	S.COI MLG1608B 12NJ-T	T	27.7/47.1
L468	6200009590	S.COI MLG1608B 18NJ-T	T	26.1/48.3
L469	6200009580	S.COI MLG1608B 15NJ-T	T	33.6/41.3
L471	6140002810	S.COI LR-317	T	38.7/37.2
L472	6200009680	S.COI MLG1608B 47NJ-T	T	33.4/39.3
L473	6200009540	S.COI MLG1608B 22NJ-T	T	35.5/40.4
L501	6200002611	S.COI NLV25T-R47J	B	21.7/43.6
L502	6200002631	S.COI NLV25T-R10J	B	18.1/46.7
L503	6200002431	S.COI NLV25T-082J	B	15/46.4
L504	6200002411	S.COI NLV25T-056J	T	14.3/49.1
L505	6200002421	S.COI NLV25T-068J	T	11.2/50.2
L506	6200002421	S.COI NLV25T-068J	T	8.2/49.7
L507	6200002611	S.COI NLV25T-R47J	T	3.8/48.2
L551	6200002611	S.COI NLV25T-R47J	T	24.9/42.6
L552	6200002421	S.COI NLV25T-068J	T	20.3/43
L553	6200002411	S.COI NLV25T-056J	T	17.6/42.9
L554	6200002601	S.COI NLV25T-047J	T	14.7/45
L555	6200002601	S.COI NLV25T-047J	T	12/44.3
L556	6200002581	S.COI NLV25T-033J	T	9.2/45
L557	6200002611	S.COI NLV25T-R47J	T	4.5/42.8
L601	6200002611	S.COI NLV25T-R47J	T	25.3/37.4
L602	6200002601	S.COI NLV25T-047J	T	22.6/39.6
L603	6200002591	S.COI NLV25T-039J	T	19.7/39.1
L604	6200003891	S.COI NLV25T-027J	T	16.8/39.9
L605	6200002601	S.COI NLV25T-047J	T	14.1/37.9
L606	6200002601	S.COI NLV25T-047J	T	11.4/37.7
L607	6200002421	S.COI NLV25T-068J	T	8.6/37.7
L608	6200002601	S.COI NLV25T-047J	T	5.1/37.7
L651	6200002611	S.COI NLV25T-R47J	T	26/32.2
L652	6200002591	S.COI NLV25T-039J	T	22.4/32.5
L653	6200002591	S.COI NLV25T-039J	T	19.6/32.8
L654	6200002591	S.COI NLV25T-039J	T	14/34.6
L655	6200002591	S.COI NLV25T-039J	T	11.2/33.9
L656	6200002601	S.COI NLV25T-047J	T	16.7/32.5
L657	6200002581	S.COI NLV25T-033J	T	7.9/34.6
L658	6200002611	S.COI NLV25T-R47J	T	5.2/32.6
L701	6200002611	S.COI NLV25T-R47J	T	26/26.9
L702	6200002581	S.COI NLV25T-033J	T	22.9/29.2
L703	6200002581	S.COI NLV25T-033J	T	20.2/28.7
L704	6200003891	S.COI NLV25T-027J	T	17.3/29.5
L705	6200002591	S.COI NLV25T-039J	T	14.6/27.3
L706	6200002581	S.COI NLV25T-033J	T	11.8/27.3
L707	6200002581	S.COI NLV25T-033J	T	9.1/27.2
L708	6200002611	S.COI NLV25T-R47J	T	4.5/27.2
L751	6200002611	S.COI NLV25T-R47J	T	25.9/22
L752	6200003881	S.COI NLV25T-022J	T	22.4/22.2
L753	6200003891	S.COI NLV25T-027J	T	19.7/22.2
L754	6200002581	S.COI NLV25T-033J	T	16.9/22.5
L755	6200003891	S.COI NLV25T-027J	T	14.2/22.1
L756	6200003891	S.COI NLV25T-027J	T	11.4/23.5
L757	6200003881	S.COI NLV25T-022J	T	8.7/24.2
L758	6200002611	S.COI NLV25T-R47J	T	3.9/22.2
L801	6200002181	S.COI NLV25T-R12J	T	28.3/17.5
L803	6200005711	S.COI ELJRE 27NGFA	T	26.3/17.6
L804	6200009070	S.COI LQW18AN18NG00D	T	25/15.6
L805	6200009220	S.COI LQW18AN15NG00D	T	23.1/14.9
		(LQW1608A15NG00)		
L806	6200005641	S.COI ELJRE 6N8ZFA	T	21.5/19
L807	6200009670	S.COI MLG1608B 12NJ-T	T	18.7/18.2
L808	6200004720	S.COI MLF1608D R10K-T	T	17.9/10
L812	6200005711	S.COI ELJRE 27NGFA	T	14.8/14.4
L813	6200009070	S.COI LQW18AN18NG00D	T	15.7/17.2
		(LQW1608A18NG00)		
L814	6200009220	S.COI LQW18AN15NG00D	T	13.8/18.2
		(LQW1608A15NG00)		
L815	6200005641	S.COI ELJRE 6N8ZFA	T	10.1/18
L816	6200010700	S.COI LQW18AN12NG00D	T	6.6/17.8
L818	6200002181	S.COI NLV25T-R12J	T	4.6/17
L851	6200002181	S.COI NLV25T-R12J	B	26.8/30.6
L852	6200002611	S.COI NLV25T-R47J	B	26.4/34.1
L853	6200002181	S.COI NLV25T-R12J	B	3.4/22.8
L854	6200002611	S.COI NLV25T-R47J	B	5.4/26
L901	6200007420	S.COI ELJFC 101K-F	B	3.7/65.9
L953	6200002041	S.COI NLV25T-101J	B	56.4/44.6
L954	6200002041	S.COI NLV25T-101J	B	55.7/42.1
L955	6200002041	S.COI NLV25T-101J	B	55.9/39.6
L956	6200002041	S.COI NLV25T-101J	B	56.1/37.1
L957	6200002041	S.COI NLV25T-101J	B	55.9/34.6
L959	6200011300	S.COI EXCML16A270U	T	54.9/34.3
L960	6200002041	S.COI NLV25T-101J	B	56.6/30.3
L962	6200011300	S.COI EXCML16A270U	B	59.2/32.2
L963	6200011300	S.COI EXCML16A270U	B	60.4/32.2
L1001	6200003241	S.COI NLV32T-221J	B	53.7/50.8
L1002	6200003241	S.COI NLV32T-221J	B	47.9/55
L1103	6200002041	S.COI NLV25T-101J	B	42.2/61.2
L1105	6200002041	S.COI NLV25T-101J	B	40.8/71.8
L1106	6200002041	S.COI NLV25T-101J	T	36.4/62.3
L1107	6200002041	S.COI NLV25T-101J	B	34.9/74.7
L1110	6200002041	S.COI NLV25T-101J	T	32.4/62.3

M.=Mounted side (T: Mounted on the Top side, B: Mounted on the Bottom side)
S.=Surface mount

[DDS UNIT]

REF NO.	PARTS NO.	DESCRIPTION	M.	H/V LOCATION
L1111	6200002041	S.COI NLV25T-101J	B	26.1/69.8
L1112	6200002041	S.COI NLV25T-101J	T	29.9/62.3
L1152	6200003590	S.COI EXCCL325U1	T	48.3/69.2
L1153	6200002041	S.COI NLV25T-101J	T	45.5/69.3
L1154	6200002041	S.COI NLV25T-101J	T	53.6/69.2
R2	7030007290	S.RES ERJ2GEJ 222 X (2.2K)	T	19.1/4.5
R3	7030005040	S.RES ERJ2GEJ 472 X (4.7K)	T	18.6/1.8
R4	7030004990	S.RES ERJ2GEJ 221 X (220)	T	22.2/2.6
R5	7030004980	S.RES ERJ2GEJ 101 X (100)	T	20.9/6.9
R8	7030003630	S.RES ERJ3GEYJ 393 V (39K)	B	13.6/7.1
R9	7030003610	S.RES ERJ3GEYJ 273 V (27K)	B	13.6/9.7
R10	7030005060	S.RES ERJ2GEJ 333 X (33K)	T	8/3.2
R11	7030010040	S.RES ERJ2GEJ-JPW	T	9.2/3.7
R51	7030005120	S.RES ERJ2GEJ 102 X (1K)	T	35.7/9.5
R52	7030005120	S.RES ERJ2GEJ 102 X (1K)	T	46.1/2.3
R53	7030005120	S.RES ERJ2GEJ 102 X (1K)	T	42.8/3.5
R54	7030005120	S.RES ERJ2GEJ 102 X (1K)	T	42.8/3.5
R61	7030005050	S.RES ERJ2GEJ 103 X (10K)	T	39.3/8.1
R62	7030005530	S.RES ERJ2GEJ 100 X (10)	T	49.3/23.1
R101	7030005000	S.RES ERJ2GEJ 471 X (470)	T	25.2/7.8
R102	7030004980	S.RES ERJ2GEJ 101 X (100)	T	22.1/7.4
R103	7030005570	S.RES ERJ2GEJ 820 X (82)	T	31.8/11.1
R104	7030004980	S.RES ERJ2GEJ 101 X (100)	T	33/11.5
R105	7030005570	S.RES ERJ2GEJ 820 X (82)	T	34.2/11.2
R106	7030005100	S.RES ERJ2GEJ 154 X (150K)	T	23.9/7.4
R121	7030005040	S.RES ERJ2GEJ 472 X (4.7K)	T	38.5/11.1
R150	7030005570	S.RES ERJ2GEJ 820 X (82)	T	45.8/10.7
R151	7030004980	S.RES ERJ2GEJ 101 X (100)	T	44.9/10.7
R154	7030005050	S.RES ERJ2GEJ 103 X (10K)	T	41.4/10.6
R155	7030005530	S.RES ERJ2GEJ 100 X (10)	T	46.3/12.6
R157	7030007270	S.RES ERJ2GEJ 151 X (150)	T	48.8/18.2
R158	7030009200	S.RES ERJ2GEJ 390 X (39)	T	48/16.7
R159	7030007270	S.RES ERJ2GEJ 151 X (150)	T	47.9/18.2
R160	7030005300	S.RES ERJ2GEJ 150 X (15)	T	44.2/15.9
R161	7030004980	S.RES ERJ2GEJ 101 X (100)	T	45.1/15.9
R162	7030005300	S.RES ERJ2GEJ 150 X (15)	T	45/14.6
R201	7030005530	S.RES ERJ2GEJ 100 X (10)	T	45.8/22
R202	7030000700	S.RES MCR10EZHJ 470 K (474)	T	45.6/18.8
R211	7030003400	S.RES ERJ3GEYJ 471 V (470)	B	37.3/17.8
R212	7030003440	S.RES ERJ3GEYJ 102 V (1K)	B	40.8/16.2
R213	7030003200	S.RES ERJ3GEYJ 100 V (10)	B	44.5/11.4
R214	7030003280	S.RES ERJ3GEYJ 470 V (47)	B	46.8/16.3
R301	7030005120	S.RES ERJ2GEJ 102 X (1K)	T	34.2/22.2
R303	7030010040	S.RES ERJ2GEJ-JPW	T	40/22.2
R304	7030005120	S.RES ERJ2GEJ 102 X (1K)	T	42/24.6
R305	7030005710	S.RES ERJ2GEJ 121 X (120)	T	44.1/28.9
R306	7030005120	S.RES ERJ2GEJ 102 X (1K)	T	31.5/25.6
R309	7030005120	S.RES ERJ2GEJ 102 X (1K)	T	31.2/29.4
R310	7030005120	S.RES ERJ2GEJ 102 X (1K)	T	31.2/30.5
R311	7030005120	S.RES ERJ2GEJ 102 X (1K)	T	31.2/31.5
R312	7030010040	S.RES ERJ2GEJ-JPW	T	32.9/31.7
R313	7030005710	S.RES ERJ2GEJ 121 X (120)	T	43.2/28.5
R314	7030009140	S.RES ERJ2GEJ 272 X (2.7K)	T	43/31.8
R315	7030005120	S.RES ERJ2GEJ 102 X (1K)	T	33.5/32.6
R316	7030005050	S.RES ERJ2GEJ 103 X (10K)	T	34.6/33.8
R317	7030004990	S.RES ERJ2GEJ 221 X (220)	T	43.9/31.8
R318	7030003860	S.RES ERJ3GE JPW V	[EUR] B	35.8/28.4
	7030003860	S.RES ERJ3GE JPW V	[FRA]	
	7030003860	S.RES ERJ3GE JPW V	[ESP]	
	7030003860	S.RES ERJ3GE JPW V	[USA]	
	7030003860	S.RES ERJ3GE JPW V	[EXP]	
	7030003860	S.RES ERJ3GE JPW V	[ITR]	
	7030003860	S.RES ERJ3GE JPW V	[KOR]	
	7030003860	S.RES ERJ3GE JPW V	[AUS]	
	7030003860	S.RES ERJ3GE JPW V	[CHN]	
R341	7030003440	S.RES ERJ3GEYJ 102 V (1K)	B	44.3/38.3
R342	7030003440	S.RES ERJ3GEYJ 102 V (1K)	B	45.9/41.2
R451	7030005120	S.RES ERJ2GEJ 102 X (1K)	T	44.5/46.2
R452	7030003860	S.RES ERJ3GE JPW V	B	48.6/44.6
R453	7030010090	S.RES ERJ2GEJ 180 X (18)	T	34.1/47.4
R454	7030008280	S.RES ERJ2GEJ 271 X (270)	T	32.9/47
R455	7030008280	S.RES ERJ2GEJ 271 X (270)	T	32.9/47.9
R456	7030010040	S.RES ERJ2GEJ-JPW	T	34.9/52.4
R457	7030005120	S.RES ERJ2GEJ 102 X (1K)	T	38.1/49.7
R458	7030004990	S.RES ERJ2GEJ 221 X (220)	T	31.6/43.6
R459	7030005090	S.RES ERJ2GEJ 104 X (100K)	T	42.1/50
R460	7030003680	S.RES ERJ3GEYJ 104 V (100K)	T	30.7/41
R461	7030005090	S.RES ERJ2GEJ 104 X (100K)	T	29.6/39.1
R462	7030003860	S.RES ERJ3GE JPW V	T	45/43.3
R463	7030003400	S.RES ERJ3GEYJ 471 V (470)	T	33.3/44
R464	7030004980	S.RES ERJ2GEJ 101 X (100)	T	40.8/47.9
R465	7030005570	S.RES ERJ2GEJ 820 X (82)	T	40.3/50
R467	7030005570	S.RES ERJ2GEJ 820 X (82)	T	40.8/48.8
R468	7030005570	S.RES ERJ2GEJ 820 X (82)	T	41.2/50
R469	7030003320	S.RES ERJ3GEYJ 101 V (100)	B	37.7/39.9
R471	7030005000	S.RES ERJ2GEJ 471 X (470)	T	41.6/37.7
R472	7030004990	S.RES ERJ2GEJ 221 X (220)	T	30.3/43.3
R473	7030007270	S.RES ERJ2GEJ 151 X (150)	T	31.7/34.5
R474	7030009200	S.RES ERJ2GEJ 390 X (39)	T	31.3/35.7
R475	7030007270	S.RES ERJ2GEJ 151 X (150)	T	30.1/35.3
R476	7030005000	S.RES ERJ2GEJ 471 X (470)	T	29.9/37.9
R477	7030003320	S.RES ERJ3GEYJ 101 V (100)	B	35.7/38.6
R501	7030003390	S.RES ERJ3GEYJ 391 V (390)	B	21/46.1
R502	7030009280	S.RES ERJ2GEJ 391 X	T	5.8/46.8
R503	7030005090	S.RES ERJ2GEJ 104 X (100K)	T	14.3/46.8
R505	7030005570	S.RES ERJ2GEJ 820 X (82)	T	6.5/48.6
R506	7030005570	S.RES ERJ2GEJ 820 X (82)	T	6/49.8

[DDS UNIT]

REF NO.	PARTS NO.	DESCRIPTION	M.	H/V LOCATION
R507	7030005570	S.RES ERJ2GEJ 820 X (82)	T	5.6/48.6
R551	7030009280	S.RES ERJ2GEJ 391 X	T	23.1/42
R552	7030009280	S.RES ERJ2GEJ 391 X	T	6.3/42
R553	7030005090	S.RES ERJ2GEJ 104 X (100K)	T	10.1/41.6
R554	7030009200	S.RES ERJ2GEJ 390 X (39)	T	6.4/45.7
R555	7030007270	S.RES ERJ2GEJ 101 X (150)	T	7.1/44.4
R556	7030007270	S.RES ERJ2GEJ 151 X (150)	T	6.2/44.3
R601	7030008280	S.RES ERJ2GEJ 271 X (270)	T	23.2/36.1
R602	7030009280	S.RES ERJ2GEJ 391 X	T	6.8/36.6
R603	7030005090	S.RES ERJ2GEJ 104 X (100K)	T	19.6/36.4
R604	7030004980	S.RES ERJ2GEJ 101 X (100)	T	20.8/36.1
R651	7030009280	S.RES ERJ2GEJ 391 X	T	24.2/31.2
R652	7030009280	S.RES ERJ2GEJ 391 X	T	6.3/30.5
R653	7030005090	S.RES ERJ2GEJ 104 X (100K)	T	9.9/31.2
R701	7030009280	S.RES ERJ2GEJ 391 X	T	23.8/25.8
R702	7030009280	S.RES ERJ2GEJ 391 X	T	6.5/26
R703	7030005090	S.RES ERJ2GEJ 104 X (100K)	T	19.9/26
R704	7030004980	S.RES ERJ2GEJ 101 X (100)	T	7.2/27.2
R705	7030005710	S.RES ERJ2GEJ 121 X (120)	T	6.7/28.4
R706	7030004980	S.RES ERJ2GEJ 101 X (100)	T	6.3/27.2
R751	7030009280	S.RES ERJ2GEJ 391 X	T	24.2/21
R752	7030009280	S.RES ERJ2GEJ 391 X	T	5.9/20.8
R753	7030005090	S.RES ERJ2GEJ 104 X (100K)	T	10.3/20.8
R755	7030004980	S.RES ERJ2GEJ 101 X (100)	T	6.6/22.6
R756	7030005580	S.RES ERJ2GEJ 560 X (56)	T	6.6/24.2
R757	7030004980	S.RES ERJ2GEJ 101 X (100)	T	5.7/23.3
R801	7030008280	S.RES ERJ2GEJ 271 X (270)	T	27.2/14.5
R805	7030005570	S.RES ERJ2GEJ 820 X (82)	T	13.9/10.3
R806	7030005570	S.RES ERJ2GEJ 820 X (82)	T	14.2/11.7
R807	7030005570	S.RES ERJ2GEJ 820 X (82)	T	13/11.3
R808	7030003390	S.RES ERJ3GEYJ 391 V (390)	B	3.6/17.9
R810	7030005090	S.RES ERJ2GEJ 104 X (100K)	T	27.2/15.4
R841	7030005710	S.RES ERJ2GEJ 121 X (120)	T	21.2/12.5
R851	7030009280	S.RES ERJ2GEJ 391 X	T	27.1/37.3
R852	7030008280	S.RES ERJ2GEJ 271 X (270)	T	5.7/13.7
R853	7030010090	S.RES ERJ2GEJ 180 X (18)	T	6.9/14
R854	7030008280	S.RES ERJ2GEJ 271 X (270)	T	6.9/13
R855	7030003390	S.RES ERJ3GEYJ 391 V (390)	B	5.5/29.5
R901	7030005120	S.RES ERJ2GEJ 102 X (1K)	T	2.1/62.6
R902	7030005120	S.RES ERJ2GEJ 102 X (1K)	T	2.2/60.9
R903	7030005120	S.RES ERJ2GEJ 102 X (1K)	T	2.2/58.7
R951	7030003360	S.RES ERJ3GEYJ 221 V (220)	B	59.2/6.9
R952	7030004990	S.RES ERJ2GEJ 221 X (220)	T	54/9.3
R953	7030003360	S.RES ERJ3GEYJ 221 V (220)	B	59.5/3.3
R954	7030004990	S.RES ERJ2GEJ 221 X (220)	T	53.1/8.9
R955	7030004990	S.RES ERJ2GEJ 221 X (220)	T	55.2/7.7
R956	7030003360	S.RES ERJ3GEYJ 221 V (220)	B	59.2/4.9
R957	7030003360	S.RES ERJ3GEYJ 221 V (220)	B	56.6/5
R958	7030004990	S.RES ERJ2GEJ 221 X (220)	T	47.2/6.1
R959	7030003360	S.RES ERJ3GEYJ 221 V (220)	B	57.9/5.1
R960	7030003280	S.RES ERJ3GEYJ 470 V (47)	B	57.5/49
R961	7030004990	S.RES ERJ2GEJ 221 X (220)	T	54.6/11.6
R962	7030003860	S.RES ERJ3GE JPW V	T	51.3/21
R1051	7030003860	S.RES ERJ3GE JPW V	T	10.8/73
R1101	7030005120	S.RES ERJ2GEJ 102 X (1K)	T	40.5/52.1
R1102	7030005050	S.RES ERJ2GEJ 103 X (10K)	T	42.1/52.1
R1103	7030004980	S.RES ERJ2GEJ 101 X (100)	T	39.3/63.4
R1104	7030005050	S.RES ERJ2GEJ 103 X (10K)	T	44.2/51.2
R1105	7030004980	S.RES ERJ2GEJ 101 X (100)	T	38.7/60.9
R1106	7030007290	S.RES ERJ2GEJ 222 X (2.2K)	T	31.8/59.6
R1107	7030007290	S.RES ERJ2GEJ 222 X (2.2K)	T	28.1/59.6
R1108	7030005240	S.RES ERJ2GEJ 473 X (47K)	T	46.9/8.5
R1109	7030005240	S.RES ERJ2GEJ 473 X (47K)	T	47.9/8.5
C1	4030016950	S.CER ECJ0EB1A473K	T	17.5/4.5
C2	4030017780	S.CER ECJ0EB1E472K	T	20.9/5
C3	4030017510	S.CER ECJ0EC1H680J	T	24.8/1.7
C4	4030017780	S.CER ECJ0EB1E472K	T	22.3/4.6
C5	4030017680	S.CER ECJ0EC1H820J	T	26/2
C6	4030017510	S.CER ECJ0EC1H680J	T	27.2/1.7
C7	4030016930	S.CER ECJ0EB1A104K	T	8/4.1
C8	4030016790	S.CER ECJ0EB1C103K	T	10.1/5.7
C51	4030017780	S.CER ECJ0EB1E472K	T	33.8/6.5
C52	4030017780	S.CER ECJ0EB1E472K	T	36.1/5.3
C53	4030017780	S.CER ECJ0EB1E472K	T	36.9/9.4
C54	4030016930	S.CER ECJ0EB1A104K	T	34.9/4.4
C55	4510008580	S.ELE EEE0JA470SR	T	30.6/3.9
C56	4030016930	S.CER ECJ0EB1A104K	T	34.9/2.8
C57	4030016930	S.CER ECJ0EB1A104K	T	42.8/5
C58	4030016930	S.CER ECJ0EB1A104K	T	41.5/9
C59	4030017720	S.CER ECJ0EB1H331K	T	41.9/6.6
C60	4030017690	S.CER ECJ0EC1H121J	T	42.2/7.8
C61	4030017720	S.CER ECJ0EB1H331K	T	42.8/6.6
C62	4030016930	S.CER ECJ0EB1A104K	T	35.6/6.5
C63	4030016930	S.CER ECJ0EB1A104K	T	49.3/22.2
C64	4030017710	S.CER ECJ0EC1H181J	T	34.7/6.5
C65	4030017710	S.CER ECJ0EC1H181J	T	33.4/8.9
C101	4030017580	S.CER ECJ0EC1H060C	T	26.4/8.7
C102	4030017660	S.CER ECJ0EC1H330J	T	23.1/2.6
C104	4030017780	S.CER ECJ0EB1E472K	T	20.9/7.8
C105	4030017460	S.CER ECJ0EB1E102K	T	24.8/6.5
C120	4030017780	S.CER ECJ0EB1E472K	T	37.3/11.5
C126	4030017780	S.CER ECJ0EB1E472		

[DDS UNIT]

REF NO.	PARTS NO.	DESCRIPTION	M.	H/V LOCATION
C156	4030017660	S.CER ECJ0EC1H330J	T	47/18.2
C157	4030007090	S.CER C1608 CH 1H 470J-T	B	53/15.3
C202	4030017590	S.CER ECJ0EC1H070C	T	43.8/17.2
C203	4030007060	S.CER C1608 CH 1H 270J-T	B	37.8/15.9
C204	4030016930	S.CER ECJ0EB1A104K	T	35.1/20.1
C206	4030017560	S.CER ECJ0EC1H2R5B	T	43.4/21.7
C207	4030007110	S.CER C1608 CH 1H 680J-T	B	44/21.7
C208	4030009910	S.CER C1608 CH 1H 040B-T	B	40.9/21.7
C209	4030007060	S.CER C1608 CH 1H 270J-T	B	43.1/20.4
C210	4030009910	S.CER C1608 CH 1H 040B-T	B	40.8/19.8
C211	4030017460	S.CER ECJ0EB1E102K	T	42.2/17.6
C216	4030017780	S.CER ECJ0EB1E472K	T	46.3/20.8
C217	4030007120	S.CER C1608 CH 1H 820J-T	B	43.9/19.1
C218	4030011770	S.CER C1608 CH 1H 060B-T	B	43.2/17.8
C219	4030007010	S.CER C1608 CH 1H 100D-T	B	46.2/17.8
C221	4030006880	S.CER C1608 JB 1H 472K-T	B	46/15
C222	4030009910	S.CER C1608 CH 1H 040B-T	B	40.7/14.7
C223	4030006880	S.CER C1608 JB 1H 472K-T	B	46/13.4
C224	4030018630	S.CER C2012 CH 1H 472J-T	B	39.2/11.4
C225	4030006860	S.CER C1608 JB 1H 102K-T	B	38.4/19.4
C251	4030011600	S.CER C1608 JB 1E 104K-T	B	27.6/12.2
C252	4030011600	S.CER C1608 JB 1E 104K-T	B	28.7/23.5
C253	4550007090	S.TAN TEESVA 1A 226M8R	B	29.6/21.7
C254	4030011600	S.CER C1608 JB 1E 104K-T	B	29.2/12.2
C255	4550007090	S.TAN TEESVA 1A 226M8R	B	29.5/19.3
C302	4030016930	S.CER ECJ0EB1A104K	T	36.2/22.2
C303	4030016930	S.CER ECJ0EB1A104K	T	37.3/22.2
C304	4030016930	S.CER ECJ0EB1A104K	T	38.2/22.2
C305	4030016930	S.CER ECJ0EB1A104K	T	39.1/22.2
C306	4030016930	S.CER ECJ0EB1A104K	T	43.6/24.6
C307	4030016930	S.CER ECJ0EB1A104K	T	31.2/28.3
C308	4030016930	S.CER ECJ0EB1A104K	T	43.6/25.5
C309	4030016930	S.CER ECJ0EB1A104K	T	43/26.7
C310	4030016930	S.CER ECJ0EB1A104K	T	43.9/26.7
C312	4030016930	S.CER ECJ0EB1A104K	T	43.4/30.6
C317	4030011600	S.CER C1608 JB 1E 104K-T	B	44/26.1
C318	4030006880	S.CER C1608 JB 1H 472K-T	B	39.2/25.4
C321	4030017420	S.CER ECJ0EC1H470J	T	51.2/30.2
C323	4030017510	S.CER ECJ0EC1H680J	T	48.6/33.3
C325	4030017660	S.CER ECJ0EC1H330J	T	48.8/35.7
C326	4030017640	S.CER ECJ0EC1H150J	T	53.1/32
C327	4030006880	S.CER C1608 JB 1H 472K-T	[UK] only	
C328	4030006880	S.CER C1608 JB 1H 472K-T	[EUR]	39.7/29.6
	4030006880	S.CER C1608 JB 1H 472K-T	[FRA]	
	4030006880	S.CER C1608 JB 1H 472K-T	[ESP]	
	4030006880	S.CER C1608 JB 1H 472K-T	[USA]	
	4030006880	S.CER C1608 JB 1H 472K-T	[EXPT]	
	4030006880	S.CER C1608 JB 1H 472K-T	[ITR]	
	4030006880	S.CER C1608 JB 1H 472K-T	[KOR]	
	4030006880	S.CER C1608 JB 1H 472K-T	[AUS]	
	4030006880	S.CER C1608 JB 1H 472K-T	[CHN]	
C331	4030017390	S.CER ECJ0EC1H180J	T	46.6/44.5
C333	4030017670	S.CER ECJ0EC1H390J	T	48.4/44.5
C335	4030017390	S.CER ECJ0EC1H180J	T	50.2/44.5
C341	4030007130	S.CER C1608 CH 1H 101J-T	[EUR]	42.5/39.7
	4030007130	S.CER C1608 CH 1H 101J-T	[FRA]	
	4030007130	S.CER C1608 CH 1H 101J-T	[ESP]	
	4030007130	S.CER C1608 CH 1H 101J-T	[USA]	
	4030007130	S.CER C1608 CH 1H 101J-T	[EXPT]	
	4030007130	S.CER C1608 CH 1H 101J-T	[ITR]	
	4030007090	S.CER C1608 CH 1H 470J-T	[UK]	
	4030007130	S.CER C1608 CH 1H 101J-T	[KOR]	
	4030007130	S.CER C1608 CH 1H 101J-T	[AUS]	
	4030007130	S.CER C1608 CH 1H 101J-T	[CHN]	
C342	4030007090	S.CER C1608 CH 1H 470J-T	B	43.7/42.1
C343	4030007140	S.CER C1608 CH 1H 121J-T	B	41.3/39
C344	4030007100	S.CER C1608 CH 1H 560J-T	B	42.7/34.3
C345	4030017510	S.CER ECJ0EC1H680J	T	45.5/37.9
C346	4030017510	S.CER ECJ0EC1H680J	T	45.7/39.7
C347	4030006860	S.CER C1608 JB 1H 102K-T	[EUR]	48.4/31.7
	4030006860	S.CER C1608 JB 1H 102K-T	[FRA]	
	4030006860	S.CER C1608 JB 1H 102K-T	[ESP]	
	4030006860	S.CER C1608 JB 1H 102K-T	[USA]	
	4030006860	S.CER C1608 JB 1H 102K-T	[EXPT]	
	4030006860	S.CER C1608 JB 1H 102K-T	[ITR]	
	4030006860	S.CER C1608 JB 1H 102K-T	[KOR]	
	4030006860	S.CER C1608 JB 1H 102K-T	[AUS]	
	4030006860	S.CER C1608 JB 1H 102K-T	[CHN]	
C401	4030017460	S.CER ECJ0EB1E102K	T	51.1/44.5
C402	4030017460	S.CER ECJ0EB1E102K	T	52.3/48.9
C403	4030017430	S.CER ECJ0EC1H101J	T	47.9/46.1
C411	4030017400	S.CER ECJ0EC1H220J	T	48.1/49.7
C412	4030017630	S.CER ECJ0EC1H120J	T	47.7/47.3
C413	4030017400	S.CER ECJ0EC1H220J	T	46.7/49.4
C451	4030017420	S.CER ECJ0EC1H470J	T	40.2/40.6
C453	4030017460	S.CER ECJ0EB1E102K	T	46.1/46.8
C454	4030017460	S.CER ECJ0EB1E102K	T	35.3/47.9
C456	4030016930	S.CER ECJ0EB1A104K	T	31.2/48
C457	4030017460	S.CER ECJ0EB1E102K	T	35.3/47
C458	4030017460	S.CER ECJ0EB1E102K	T	30.5/49.8
C459	4030017460	S.CER ECJ0EB1E102K	T	27/50.6
C460	4030017780	S.CER ECJ0EB1E472K	T	39.3/50
C461	4030006880	S.CER C1608 JB 1H 472K-T	T	30.7/42.2
C463	4030017420	S.CER ECJ0EC1H470J	T	40.6/41.8
C464	4030017690	S.CER ECJ0EC1H121J	T	41.5/40.2
C465	4030017400	S.CER ECJ0EC1H220J	T	37.7/41.8
C466	4030017570	S.CER ECJ0EC1H040B	T	38.1/40.6
C467	4030017400	S.CER ECJ0EC1H220J	T	37.2/40.6
C468	4030017360	S.CER ECJ0EC1H030B	T	29/48

[DDS UNIT]

REF NO.	PARTS NO.	DESCRIPTION	M.	H/V LOCATION
C469	4030017370	S.CER ECJ0EC1H3R5B	T	29/47.1
C470	4030017380	S.CER ECJ0EC1H050B	T	29/46.2
C471	4030017380	S.CER ECJ0EC1H050B	T	35.6/43.9
C472	4030017660	S.CER ECJ0EC1H330J	T	34.7/41.8
C473	4030017570	S.CER ECJ0EC1H040B	T	34/43
C474	4030017460	S.CER ECJ0EB1E102K	T	41.6/36.7
C475	4030017460	S.CER ECJ0EB1E102K	T	30.5/36.7
C476	4030017780	S.CER ECJ0EB1E472K	T	29.6/40
C477	4030017780	S.CER ECJ0EB1E472K	T	42.4/48.8
C478	4030006880	S.CER C1608 JB 1H 472K-T	B	39.8/39.1
C479	4030006880	S.CER C1608 JB 1H 472K-T	B	38/37.9
C480	4030017630	S.CER ECJ0EC1H120J	T	35.6/41.8
C481	4030017360	S.CER ECJ0EC1H030B	T	35.6/43
C501	4030007080	S.CER C1608 CH 1H 390J-T	B	19/42.6
C502	4030007120	S.CER C1608 CH 1H 820J-T	B	18.3/44.1
C503	4030007060	S.CER C1608 CH 1H 270J-T	B	16.1/43.8
C504	4030017780	S.CER ECJ0EB1E472K	T	16.1/49.3
C505	4030017660	S.CER ECJ0EC1H330J	T	12.6/47.2
C506	4030017620	S.CER ECJ0EC1H100C	T	12.1/48.4
C507	4030017500	S.CER ECJ0EC1H560J	T	11.4/47.2
C508	4030017580	S.CER ECJ0EC1H060C	T	10.5/48.4
C509	4030017420	S.CER ECJ0EC1H470J	T	10.2/47.2
C510	4030017350	S.CER ECJ0EC1H020B	T	8.9/47.5
C511	4030017670	S.CER ECJ0EC1H390J	T	7.7/47.2
C512	4030017780	S.CER ECJ0EB1E472K	T	5.5/50.7
C513	4030017780	S.CER ECJ0EB1E472K	T	15.9/46.8
C551	4030017650	S.CER ECJ0EC1H270J	T	22.5/45.4
C552	4030017500	S.CER ECJ0EC1H560J	T	21.1/45
C553	4030017650	S.CER ECJ0EC1H270J	T	19.2/45.4
C554	4030017780	S.CER ECJ0EB1E472K	T	15.6/43.2
C555	4030017670	S.CER ECJ0EC1H390J	T	14.5/42
C556	4030017350	S.CER ECJ0EC1H020B	T	14/43.2
C557	4030017420	S.CER ECJ0EC1H470J	T	13.1/42
C558	4030017590	S.CER ECJ0EC1H070C	T	10.4/32
C559	4030017420	S.CER ECJ0EC1H470J	T	8.9/42
C560	4030017630	S.CER ECJ0EC1H120J	T	8.4/43.2
C561	4030017660	S.CER ECJ0EC1H360J	T	7.9/42
C562	4030017780	S.CER ECJ0EB1E472K	T	4.9/45.3
C563	4030017780	S.CER ECJ0EB1E472K	T	11.7/41.6
C601	4030017780	S.CER ECJ0EB1E472K	T	24.7/39.9
C602	4030017400	S.CER ECJ0EC1H220J	T	23.3/37.6
C603	4030017360	S.CER ECJ0EC1H030B	T	21.9/37.8
C604	4030017630	S.CER ECJ0EC1H120J	T	13.3/40.4
C605	4030017620	S.CER ECJ0EC1H100C	T	11.6/40.4
C606	4030017660	S.CER ECJ0EC1H330J	T	18.4/36.9
C607	4030017600	S.CER ECJ0EC1H080C	T	17.7/38.1
C608	4030017650	S.CER ECJ0EC1H270J	T	17.2/36.9
C609	4030017640	S.CER ECJ0EC1H150J	T	16.1/38.1
C610	4030017640	S.CER ECJ0EC1H150J	T	15.9/36.9
C611	4030017440	S.CER ECJ0EC1H221J	T	12.1/39.5
C612	4030017510	S.CER ECJ0EC1H680J	T	10.2/40
C613	4030017620	S.CER ECJ0EC1H100C	T	8.2/40.1
C614	4030017640	S.CER ECJ0EC1H150J	T	5.4/40.3
C615	4030017670	S.CER ECJ0EC1H390J	T	6.8/39.9
C616	4030017780	S.CER ECJ0EB1E472K	T	6.8/38.2
C617	4030017780	S.CER ECJ0EB1E472K	T	22/36.4
C618	4030017650	S.CER ECJ0EC1H270J	T	3.3/37.1
C651	4030017620	S.CER ECJ0EC1H100C	T	24.6/34.8
C652	4030017450	S.CER ECJ0EB1E271K	T	23.7/34.8
C653	4030017590	S.CER ECJ0EC1H070C	T	21.7/35.2
C654	4030017680	S.CER ECJ0EC1H820J	T	20.4/34.8
C655	4030017600	S.CER ECJ0EC1H080C	T	19.2/35.2
C656	4030017420	S.CER ECJ0EC1H470J	T	17.9/34.8
C657	4030017630	S.CER ECJ0EC1H120J	T	16.5/35.2
C658	4030017340	S.CER ECJ0EC1H010B	T	13.3/32.8
C659	4030017360	S.CER ECJ0EC1H030B	T	9.4/32.6
C660	4030017640	S.CER ECJ0EC1H150J	T	14.6/32.3
C661	4030017650	S.CER ECJ0EC1H270J	T	12.8/31.6
C662	4030017400	S.CER ECJ0EC1H220J	T	8.5/31.6
C663	4030017380	S.CER ECJ0EC1H050B	T	8/32.8
C664	4030017460	S.CER ECJ0EB1E102K	T	5.4/34.9
C665	4030017390	S.CER ECJ0EC1H180J	T	7.6/31.6
C666	4030017780	S.CER ECJ0EB1E472K	T	11.5/31.2
C701	4030017460	S.CER ECJ0EB1E102K	T	25/29.3
C702	4030017640	S.CER ECJ0EC1H150J	T	23.6/27.2
C703	4030017540	S.CER ECJ0EC1HR75B	T	22.2/27.4
C704	4030017650	S.CER ECJ0EC1H270J	T	18.7/26.4
C705	4030017350	S.CER ECJ0EC1H020B	T	18.2/27.7
C706	4030017400	S.CER ECJ0EC1H220J	T	17.5/26.4
C707	4030017570	S.CER ECJ0EC1H040B	T	16.6/27.7
C708	4030017390	S.CER ECJ0EC1H180J	T	16.3/26.4
C709	4030017590	S.CER ECJ0EC1H070C	T	13.9/30
C710	4030017500	S.CER ECJ0EC1H560J	T	12.5/29.1
C711	4030017380	S.CER ECJ0EC1H050B	T	11.9/30
C712	4030017500	S.CER ECJ0EC1H560J	T	10.7/29.3
C713	4030017380	S.CER ECJ0EC1H050B	T	9.5/29.6
C714	4030017710	S.CER ECJ0EC1H181J	T	8.1/29.7
C715	4030017630	S.CER ECJ0EC1H120J	T	6.9/29.3
C716	4030017780	S.CER ECJ0EB1E472K	T	21.5/26
C717	4030017460	S.CER ECJ0EB1E102K	T	5.3/29.3
C751	4030017590	S.CER ECJ0EC1H070C	T	24.8/24.5
C752	4030017710	S.CER ECJ0EC		

[DDS UNIT]

REF NO.	PARTS NO.	DESCRIPTION	M.	H/V LOCATION
C760	4030017640	S.CER ECJ0EC1H150J	T	13.2/21.9
C761	4030017350	S.CER ECJ0EC1H020B	T	9.7/22.2
C762	4030017630	S.CER ECJ0EC1H120J	T	8.6/21.2
C763	4030017360	S.CER ECJ0EC1H030B	T	8.2/22.4
C764	4030017620	S.CER ECJ0EC1H100C	T	7.7/21.2
C765	4030017460	S.CER ECJ0EB1E102K	T	5.3/24.6
C766	4030017780	S.CER ECJ0EB1E472K	T	11.9/20.8
C802	4030017590	S.CER ECJ0EC1H070C	T	26.5/19.3
C803	4030017380	S.CER ECJ0EC1H050B	T	25.2/18.9
C804	4030017570	S.CER ECJ0EC1H040B	T	24.3/18.9
C806	4030017600	S.CER ECJ0EC1H080C	T	24.3/17.2
C807	4030017360	S.CER ECJ0EC1H030B	T	23.4/18.9
C808	4030017660	S.CER ECJ0EC1H330J	T	23/16.7
C809	4030017570	S.CER ECJ0EC1H040B	T	23/17.6
C810	4030017570	S.CER ECJ0EC1H040B	T	21.7/16.6
C811	4030017590	S.CER ECJ0EC1H070C	T	21.2/17.9
C812	4030017610	S.CER ECJ0EC1H090C	T	20.8/16.6
C813	4030017350	S.CER ECJ0EC1H020B	T	19.7/18.7
C814	4030017580	S.CER ECJ0EC1H060C	T	19.7/17
C815	4030017460	S.CER ECJ0EB1E102K	T	20.3/12.5
C816	4030017460	S.CER ECJ0EB1E102K	T	15.1/10.8
C817	4030017730	S.CER ECJ0EB1E471K	T	19/9
C824	4030017590	S.CER ECJ0EC1H070C	T	13/13
C825	4030017380	S.CER ECJ0EC1H050B	T	14.2/13.4
C826	4030017570	S.CER ECJ0EC1H040B	T	13/15.1
C827	4030017620	S.CER ECJ0EC1H100C	T	14.6/15.5
C828	4030017360	S.CER ECJ0EC1H030B	T	13.9/16.4
C829	4030017660	S.CER ECJ0EC1H330J	T	12.7/16.9
C830	4030017570	S.CER ECJ0EC1H040B	T	11.8/17.6
C831	4030017570	S.CER ECJ0EC1H040B	T	11.8/19.2
C832	4030017590	S.CER ECJ0EC1H070C	T	10.3/19.1
C833	4030017610	S.CER ECJ0EC1H090C	T	8.4/19.1
C834	4030017350	S.CER ECJ0EC1H020B	T	8/17.9
C835	4030017580	S.CER ECJ0EC1H060C	T	7/19.5
C838	4030017460	S.CER ECJ0EB1E102K	T	5.3/19.5
C839	4030017780	S.CER ECJ0EB1E472K	T	25.4/14.5
C840	4030017460	S.CER ECJ0EB1E102K	T	6.5/15.6
C841	4030006860	S.CER C1608 JB 1H 102K-T	B	5.1/15.3
C851	4030017780	S.CER ECJ0EB1E472K	T	4.5/14
C901	4030017780	S.CER ECJ0EB1E472K	T	2.4/68.4
C902	4030017430	S.CER ECJ0EC1H101J	T	16/53.2
C951	4030016930	S.CER ECJ0EB1A104K	T	52.3/38.2
C952	4030011600	S.CER C1608 JB 1E 104K-T	T	58.3/46.9
C953	4030016930	S.CER ECJ0EB1A104K	T	54/18.3
C954	4030017780	S.CER ECJ0EB1E472K	T	54.1/28.1
C955	4030016930	S.CER ECJ0EB1A104K	T	52.8/33.2
C956	4030016930	S.CER ECJ0EB1A104K	T	49.2/21
C957	4030016930	S.CER ECJ0EB1A104K	T	53.8/35.9
C958	4030017780	S.CER ECJ0EB1E472K	T	52.8/34.1
C959	4030017780	S.CER ECJ0EB1E472K	T	52.8/35
C960	4030016930	S.CER ECJ0EB1A104K	T	53.5/38.9
C961	4030016930	S.CER ECJ0EB1A104K	T	52.3/39.8
C962	4030016930	S.CER ECJ0EB1A104K	T	52.3/44.6
C963	4030016930	S.CER ECJ0EB1A104K	T	53.5/38
C964	4030017460	S.CER ECJ0EB1E102K	T	55/44.8
C966	4030016930	S.CER ECJ0EB1A104K	T	52.3/41.4
C967	4030016930	S.CER ECJ0EB1A104K	T	52.3/43
C968	4030018960	S.CER C3216 JB 1C 106MT-N	B	42/43.9
C969	4030006880	S.CER C1608 JB 1H 472K-T	B	48.2/23.1
C972	4030018970	S.CER C3225 JB 1C 226MT-N	B	42.2/3.5
C973	4030018970	S.CER C3225 JB 1C 226MT-N	B	29/2.7
C974	4030018970	S.CER C3225 JB 1C 226MT-N	B	32/2.7
C975	4550007140	S.TAN TEESVD 1C 107M12R	B	16.7/4.1
C976	4550007140	S.TAN TEESVD 1C 107M12R	B	23.5/10.5
C977	4550007140	S.TAN TEESVD 1C 107M12R	B	23.5/19.5
C978	4550007140	S.TAN TEESVD 1C 107M12R	B	32.3/10.5
C980	4030004720	S.CER C2012 JB 1H 102K-T	B	55.5/11
C981	4030016930	S.CER ECJ0EB1A104K	T	54.4/12.5
C982	4030006860	S.CER C1608 JB 1H 102K-T	B	14/67.1
C983	4030006860	S.CER C1608 JB 1H 102K-T	B	7.4/74
C991	4030006860	S.CER C1608 JB 1H 102K-T	B	10/68.1
C992	4030006860	S.CER C1608 JB 1H 102K-T	B	7.2/67.3
C993	4030006860	S.CER C1608 JB 1H 102K-T	B	4.2/74
C994	4030006860	S.CER C1608 JB 1H 102K-T	B	5.6/71.3
C995	4030006860	S.CER C1608 JB 1H 102K-T	B	2.2/59.2
C996	4030006860	S.CER C1608 JB 1H 102K-T	B	5/58.8
C997	4030006860	S.CER C1608 JB 1H 102K-T	B	2.9/55
C998	4030006860	S.CER C1608 JB 1H 102K-T	B	3.1/62.6
C1001	4030011600	S.CER C1608 JB 1E 104K-T	T	58.3/48.4
C1051	4030006880	S.CER C1608 JB 1H 472K-T	B	20.2/65.3
C1052	4030006880	S.CER C1608 JB 1H 472K-T	B	19.2/60.3
C1101	4030017780	S.CER ECJ0EB1E472K	T	38.9/52.1
C1102	4030017780	S.CER ECJ0EB1E472K	T	44.2/50.3
C1104	4030017780	S.CER ECJ0EB1E472K	T	42.2/62.2
C1105	4030017780	S.CER ECJ0EB1E472K	T	40.6/59.9
C1106	4030017780	S.CER ECJ0EB1E472K	T	40.4/55.9
C1107	4030017780	S.CER ECJ0EB1E472K	T	43.3/56.9
C1108	4030017460	S.CER ECJ0EB1E102K	T	40.1/62.2
C1109	4030006880	S.CER C1608 JB 1H 472K-T	B	35.1/76.9
C1110	4030017780	S.CER ECJ0EB1E472K	T	33.5/59.6
C1111	4030017780	S.CER ECJ0EB1E472K	T	29.7/59.6
C1112	4030017780	S.CER ECJ0EB1E472K	T	38.2/63.4
C1113	4030017780	S.CER ECJ0EB1E472K	T	37.1/59.7
C1114	4030017780	S.CER ECJ0EB1E472K	T	24.4/60.6
C1115	4030017780	S.CER ECJ0EB1E472K	T	35.3/59.8
C1116	4030017460	S.CER ECJ0EB1E102K	T	23.1/63.7
C1117	4030006860	S.CER C1608 JB 1H 102K-T	B	20.9/63.9
C1151	4030017780	S.CER ECJ0EB1E472K	T	50.5/66.3
C1152	4030017780	S.CER ECJ0EB1E472K	T	46.4/66.3

[DDS UNIT]

REF NO.	PARTS NO.	DESCRIPTION	M.	H/V LOCATION
C1153	4030017780	S.CER ECJ0EB1E472K	T	43.7/68.2
C1154	4030017780	S.CER ECJ0EB1E472K	T	52/66.3
C1155	4030017780	S.CER ECJ0EB1E472K	T	57.9/68.3
RL1101	6330001721	REL ATN207-K1		
J151	6510007020	CON TMP-J01X-V6		
J851	6510018450	CON TMP-S01X-B1		
J951	6510024880	S.CON 52689-3087	T	59.2/35.3
J952	6510024880	S.CON 52689-3087	T	59.2/12.4
J1001	6510003521	CON S04B-EH-S(LF)(SN)		
J1051	6450001791	CON HLJ7000-016010 2		
J1101	6450001641	CON TCS5044-0141177		
J1151	6450001841	CON TCS7568-4320177		
EP6	6910012350	S.BEA MMZ1608Y 102BT	B	12.9/11
EP251	6910012350	S.BEA MMZ1608Y 102BT	B	33.1/18.7
EP301	6910012350	S.BEA MMZ1608Y 102BT	B	49.7/25
EP302	6910012350	S.BEA MMZ1608Y 102BT	B	32.9/27.8
EP303	6910012350	S.BEA MMZ1608Y 102BT	B	32.9/26.1
EP304	6910012350	S.BEA MMZ1608Y 102BT		
EP305	6910012350	S.BEA MMZ1608Y 102BT	B	41/27.1
EP306	6910012350	S.BEA MMZ1608Y 102BT	B	36.6/26.3
EP451	6910012350	S.BEA MMZ1608Y 102BT	B	39.9/47.8
EP809	6910012350	S.BEA MMZ1608Y 102BT	B	16.6/7.1
EP951	6910012350	S.BEA MMZ1608Y 102BT	B	53.3/24.3
EP952	6910012350	S.BEA MMZ1608Y 102BT	B	50.5/21.7
EP953	6910012350	S.BEA MMZ1608Y 102BT	T	54/43.4
EP954	6910012350	S.BEA MMZ1608Y 102BT	T	54/42.1
EP955	6910012350	S.BEA MMZ1608Y 102BT	T	54.2/40
EP956	6910012350	S.BEA MMZ1608Y 102BT	T	54.6/37
EP957	6910012350	S.BEA MMZ1608Y 102BT	B	39.5/46.1
EP958	6910012350	S.BEA MMZ1608Y 102BT	B	55.9/47.4
EP959	6910012350	S.BEA MMZ1608Y 102BT	B	56.7/32.5
EP960	6910012350	S.BEA MMZ1608Y 102BT	B	56.9/28.4
EP964	6910012350	S.BEA MMZ1608Y 102BT	B	53.3/22.2
EP981	6910012350	S.BEA MMZ1608Y 102BT	T	55.3/14.2
EP1003	6910018930	S.BEA MPZ2012S601A	T	57.2/50.3
EP1004	6910018930	S.BEA MPZ2012S601A	T	53.9/50
EP1051	6910012350	S.BEA MMZ1608Y 102BT	B	20.2/66.8
EP1052	6910012350	S.BEA MMZ1608Y 102BT	B	19.2/58.7
EP1100	6910012350	S.BEA MMZ1608Y 102BT	B	38.7/63.4
EP1101	6910012350	S.BEA MMZ1608Y 102BT	T	27.5/63.3
EP1102	6910012350	S.BEA MMZ1608Y 102BT	T	34.4/62.4
EP1103	6910012350	S.BEA MMZ1608Y 102BT	T	51.1/69.2
EP1104	6910012350	S.BEA MMZ1608Y 102BT	T	56.1/69.2
EP1105	6910014730	S.BEA MPZ2012S331A-T	B	41/67.9
EP1106	6910014730	S.BEA MPZ2012S331A-T	B	34.7/61.8
EP1107	6910014730	S.BEA MPZ2012S331A-T	B	31.4/61.8
EP1108	6910014730	S.BEA MPZ2012S331A-T	B	27/73.6
MP201	8510017200	PLA 2427 A-SHIELD PLATE Y800	B	43/14.7

M.=Mounted side (T: Mounted on the Top side, B: Mounted on the Bottom side)
S.=Surface mount

The combination of this side and the bottom side shows the board layout in the same configuration as the actual P.C.Board.

• PA UNIT
(BOTTOM VIEW)

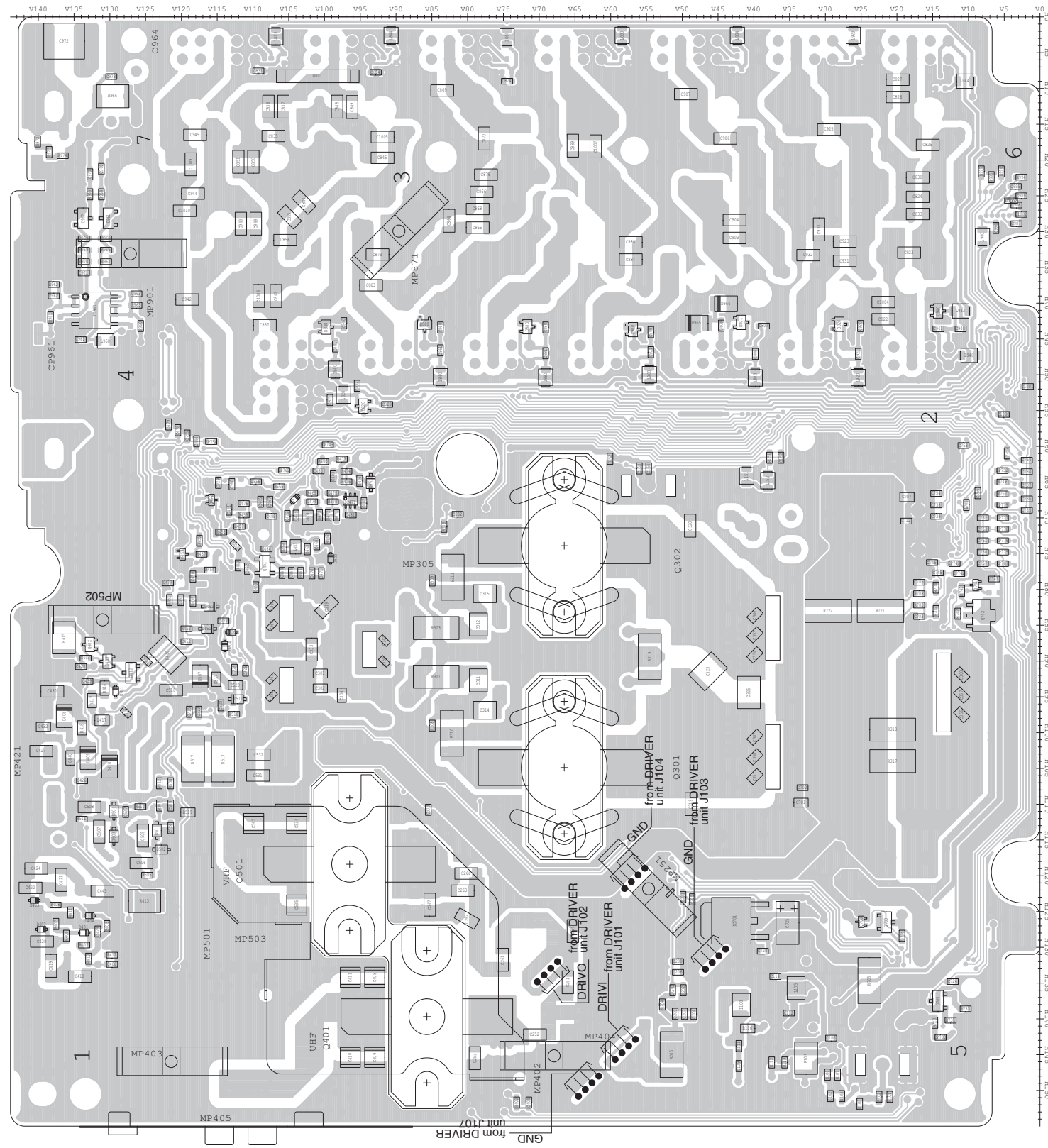

• LOGIC UNIT
(BOTTOM VIEW)

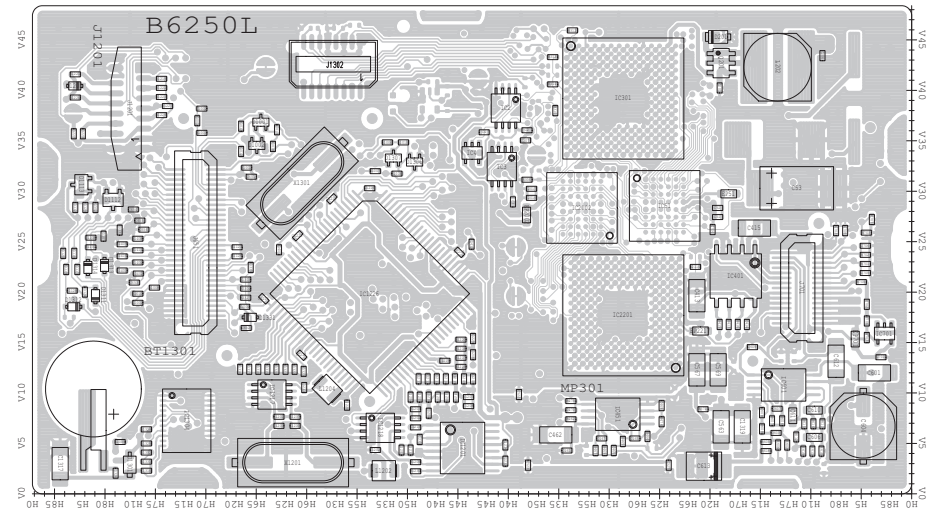

J651		1	
60	1DST	VDL	1
	3DST	MMDK	
	PDT	SQSS	
	PCK	DOTK	
	TCNO	DASK	
	TCN1	WFML	
	PRES#	LTXD	
	LOST	LRXD	
	RS_RXD	CIV	
	RS_TXD	CIVE	
	MST	START	
	MDT	KEY	
	MCK	MUDL	
	NC	FORL	
	SNDS	REFL	
	SDSS	ALCL	
	2T8V	SNDL	
	4T8V	DPTL	
	TXS	THML	
	RXS	CPU_P12	
	POWS	RTK1	
	VOUT	CPU_P22	
	PWRK	CPU_P94	
	GND	CPU_P95	
	GND	IMR	
	GND	CPU_PF6	
	GND	MMSL	
	GND	NC	
	GND	IMR2	
31	GND	NC	30

to MAIN unit J2252

J701		16	
15	GND	AFMS	16
	DSP02	MOSI	
	GND	SKC	
	DSP01	VSTB	
	GND	NC	
	DOUT	NC	
	GND	NC	
	NC	24M	
	GND	HV	
	GND	8V	
	GND	8V	
	GND	5V	
	DSP1	5V	
	GND	3V	
1	DSP12	3V	30

to MAIN unit J2251

The combination of this side and the bottom side shows the board layout in the same configuration as the actual P.C.Board.

• MAIN UNIT (TOP VIEW)

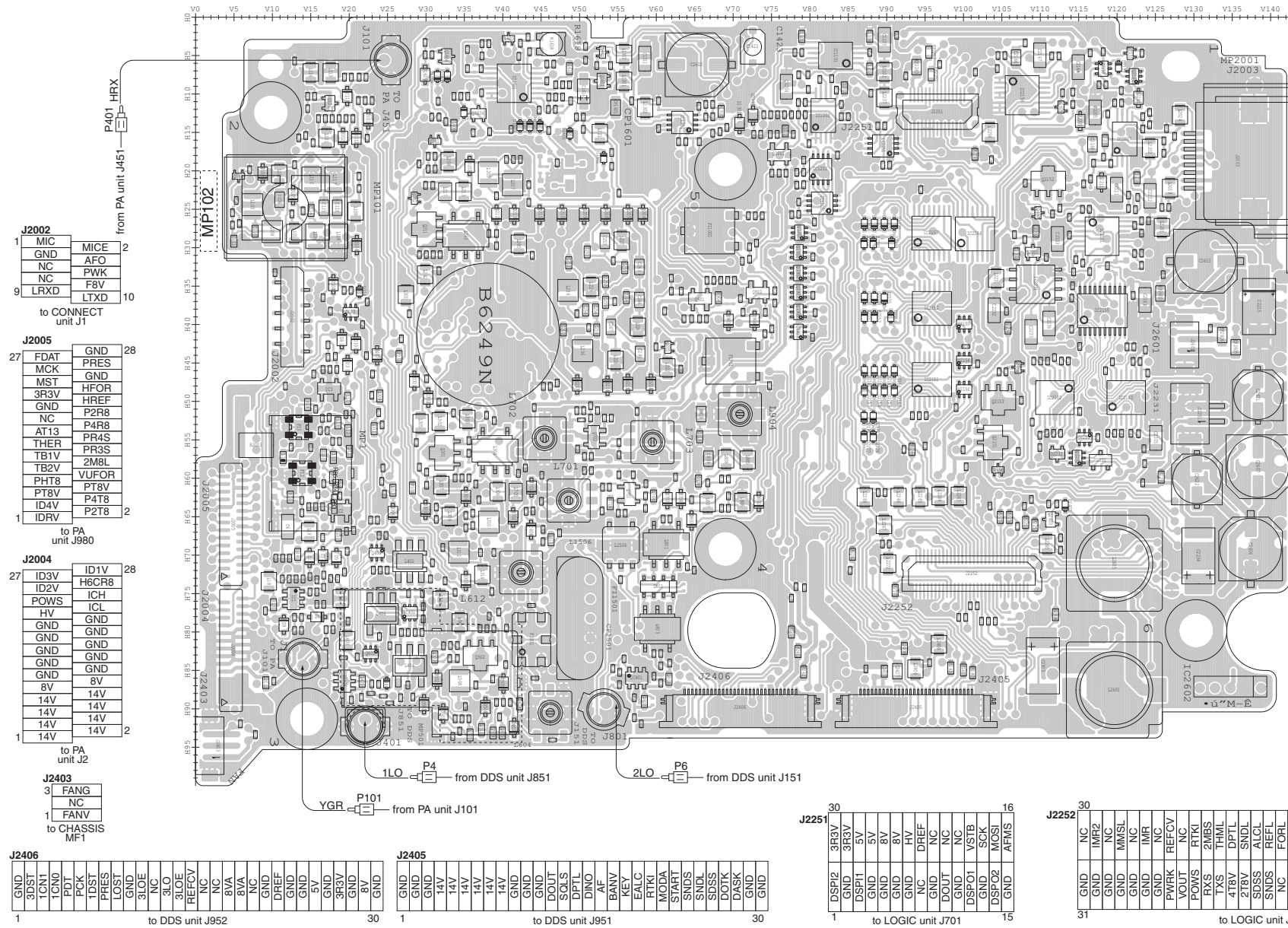

• VR UNIT (TOP VIEW)

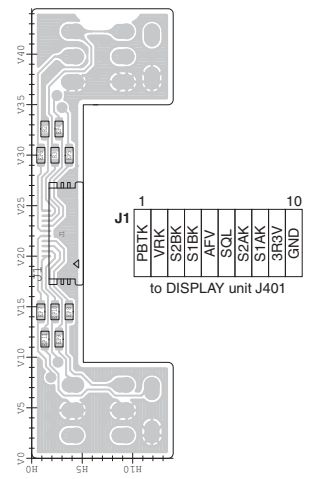

• DRIVER UNIT (TOP VIEW)

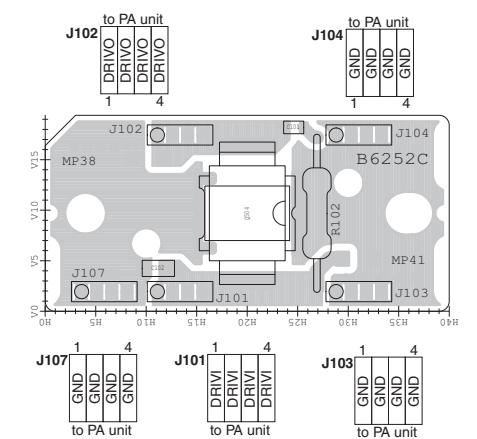

• CONNECT UNIT (TOP VIEW)

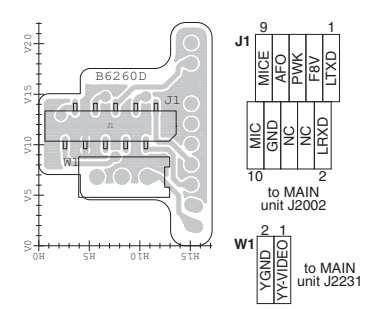

• VR UNIT
(BOTTOM VIEW)

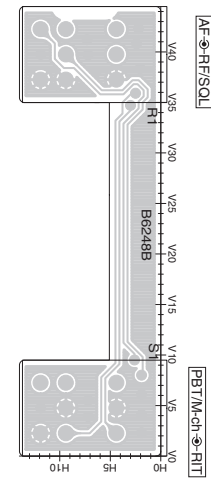

• DRIVER UNIT
(BOTTOM VIEW)

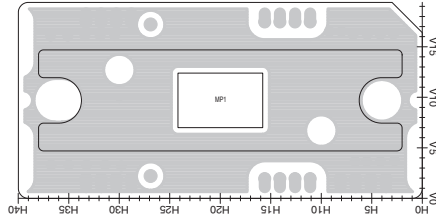

• CONNECT UNIT
(BOTTOM VIEW)

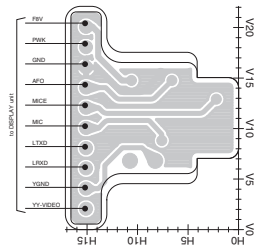

• MAIN UNIT
(BOTTOM VIEW)

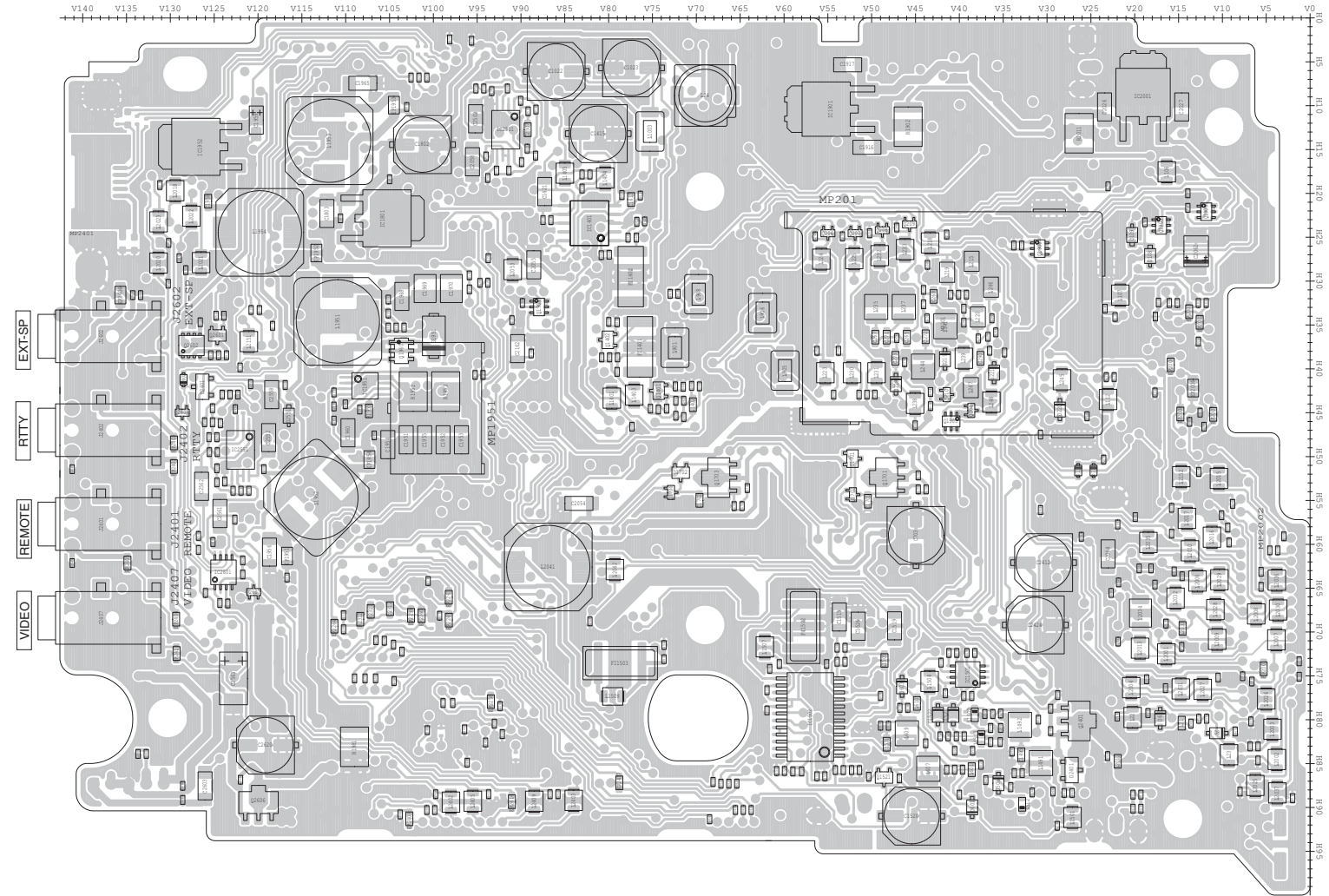

The combination of this side and the bottom side shows the board layout in the same configuration as the actual P.C.Board.

• DISPLAY UNIT
(TOP VIEW)

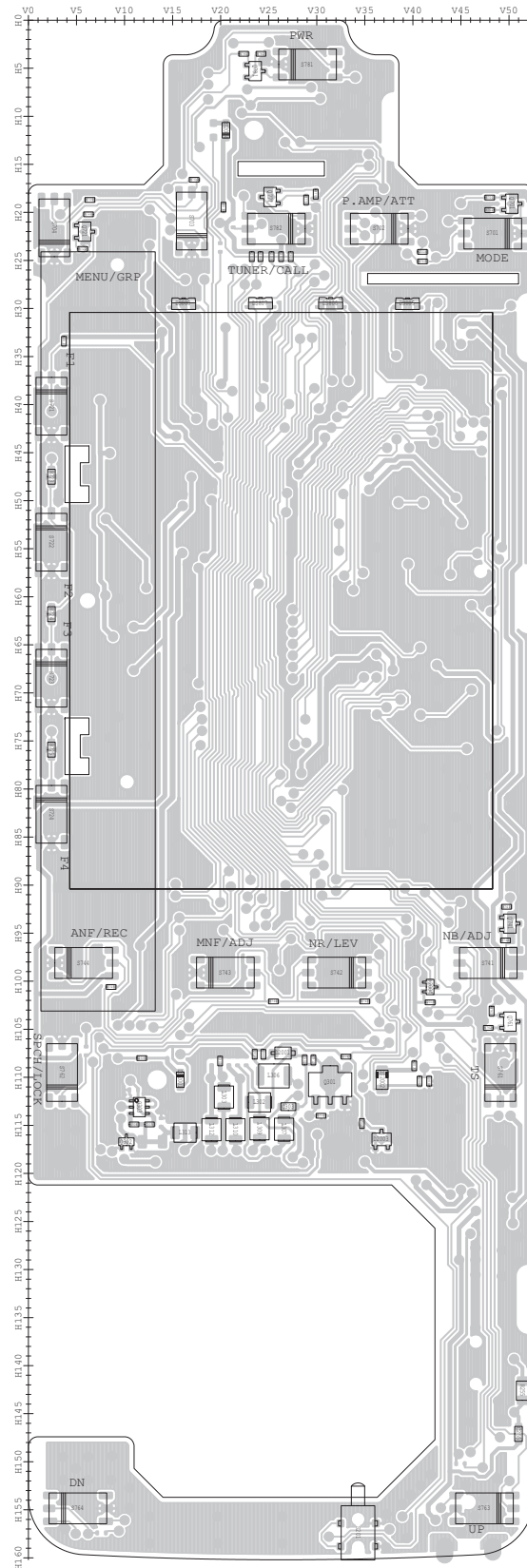

• DDS UNIT
(TOP VIEW)

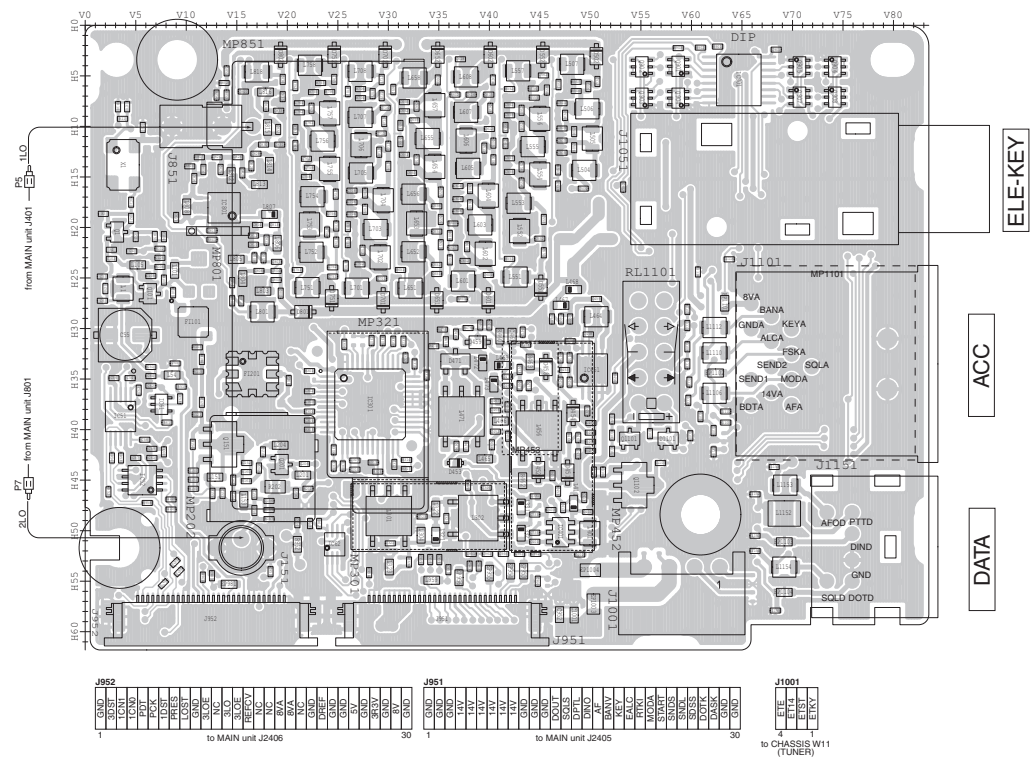

• DDS UNIT
(BOTTOM VIEW)

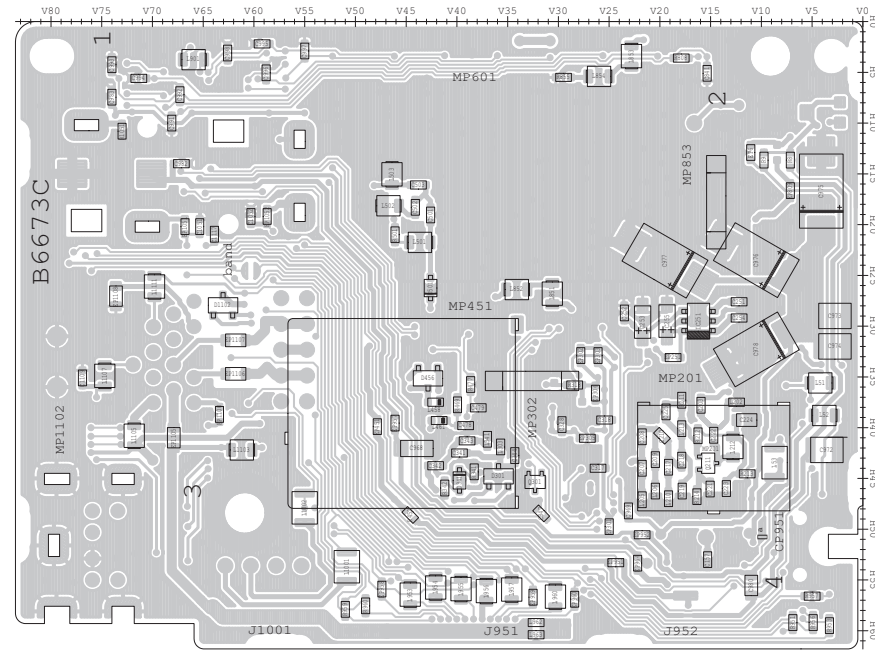

• DISPLAY UNIT
(BOTTOM VIEW)

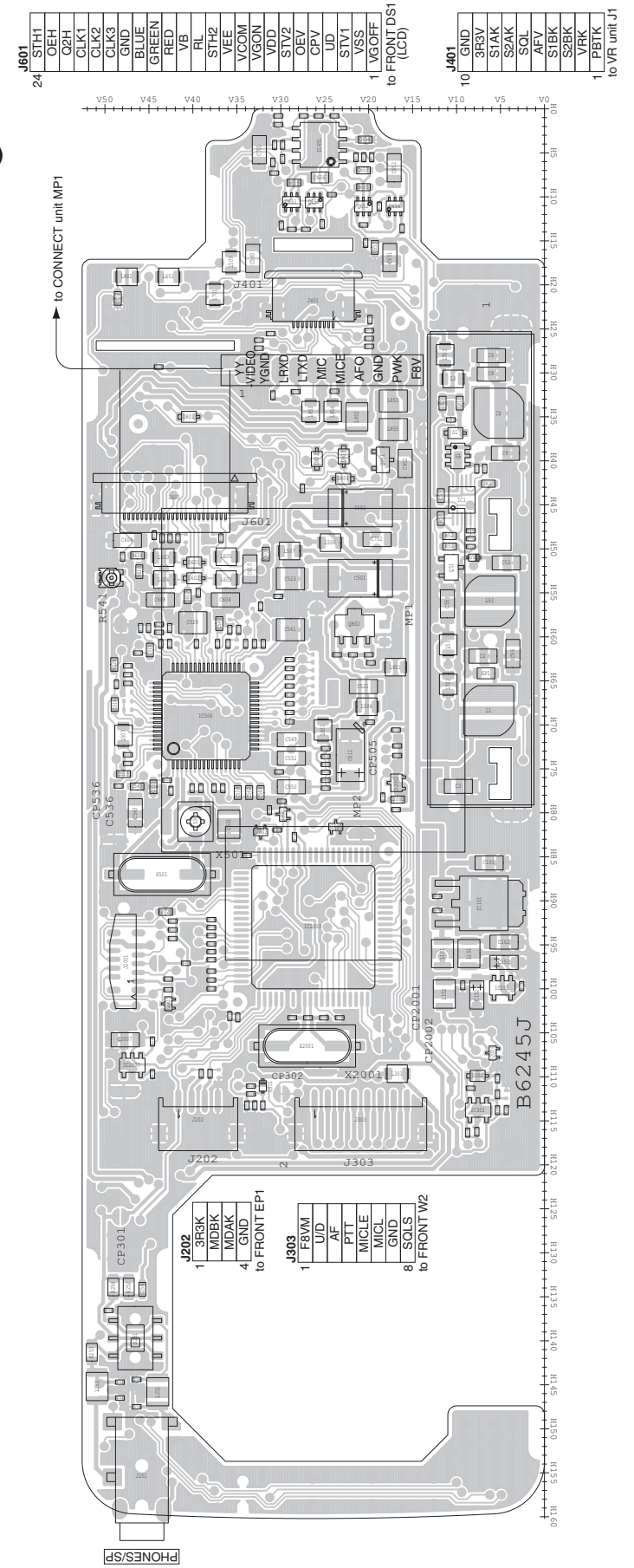

The combination of this side and the bottom side shows the board layout in the same configuration as the actual P.C.Board.

VOLTAGE DIAGRAM

• DISPLAY UNIT

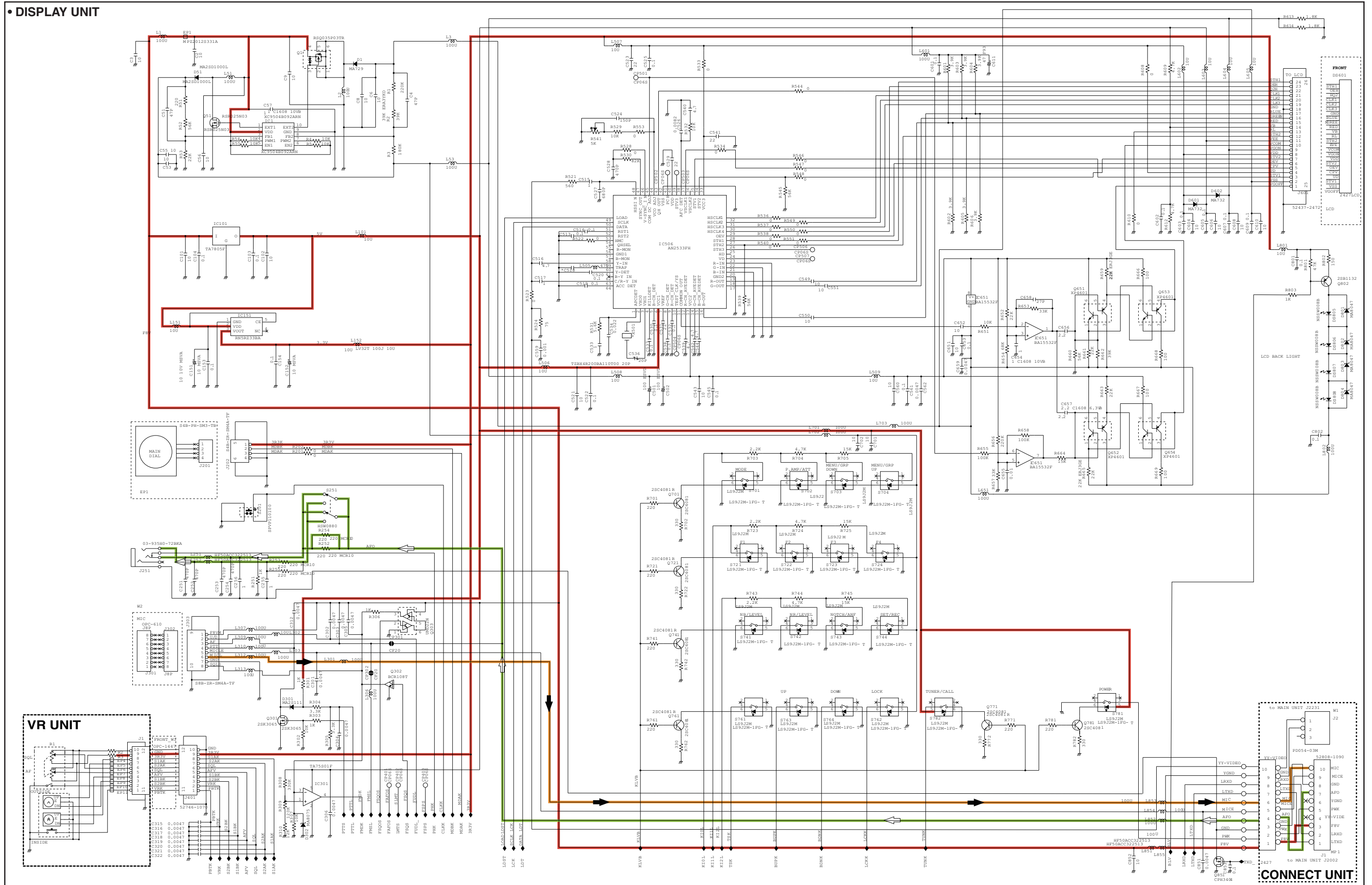

*; Refer to "PARTS LIST."

• LOGIC UNIT (3/3)

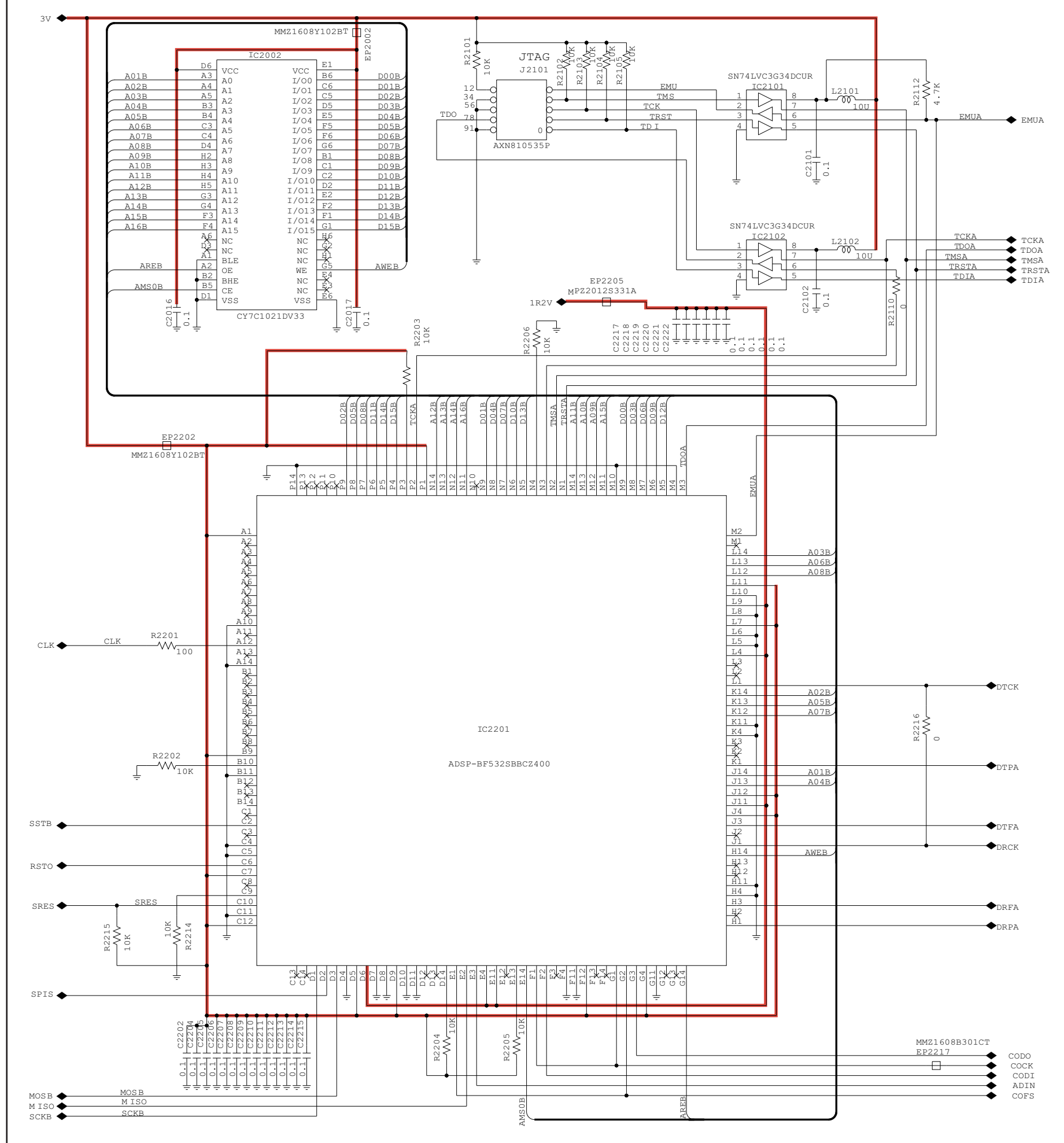

*; Refer to "PARTS LIST."

• MAIN UNIT (Left side)

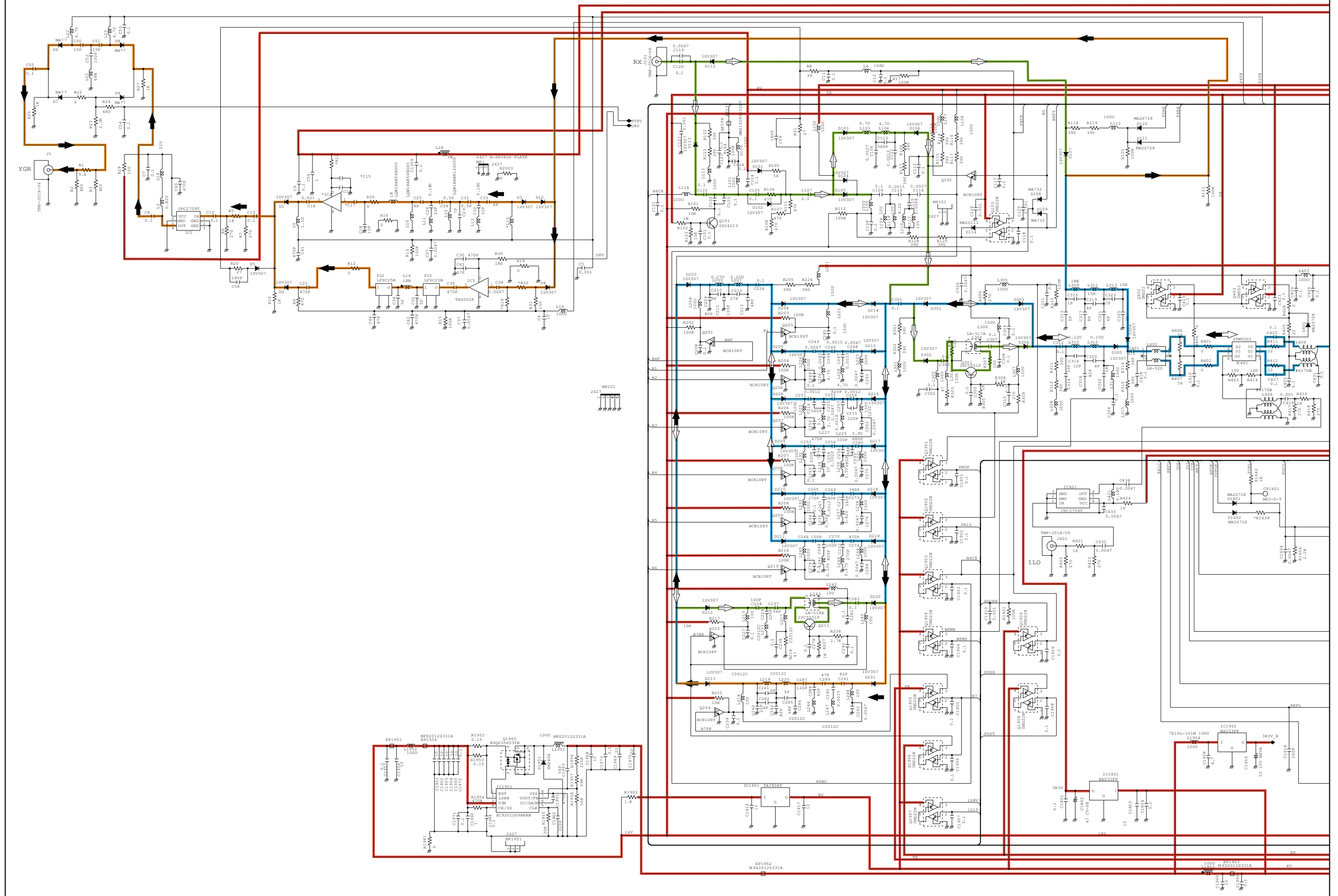

*; Refer to "PARTS LIST."

• MAIN UNIT (Right side)

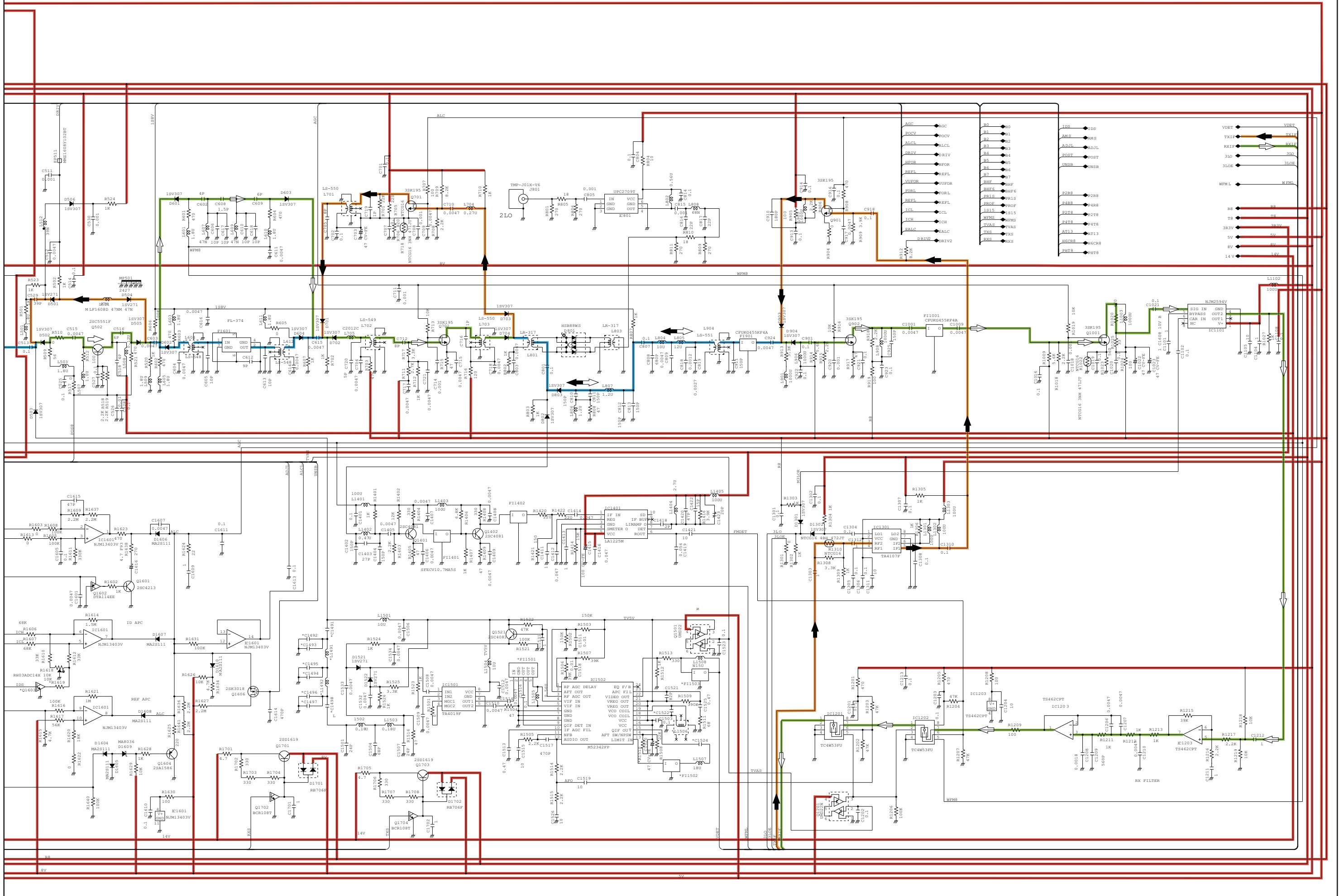

*; Refer to "PARTS LIST"

• PA UNIT (2/2)

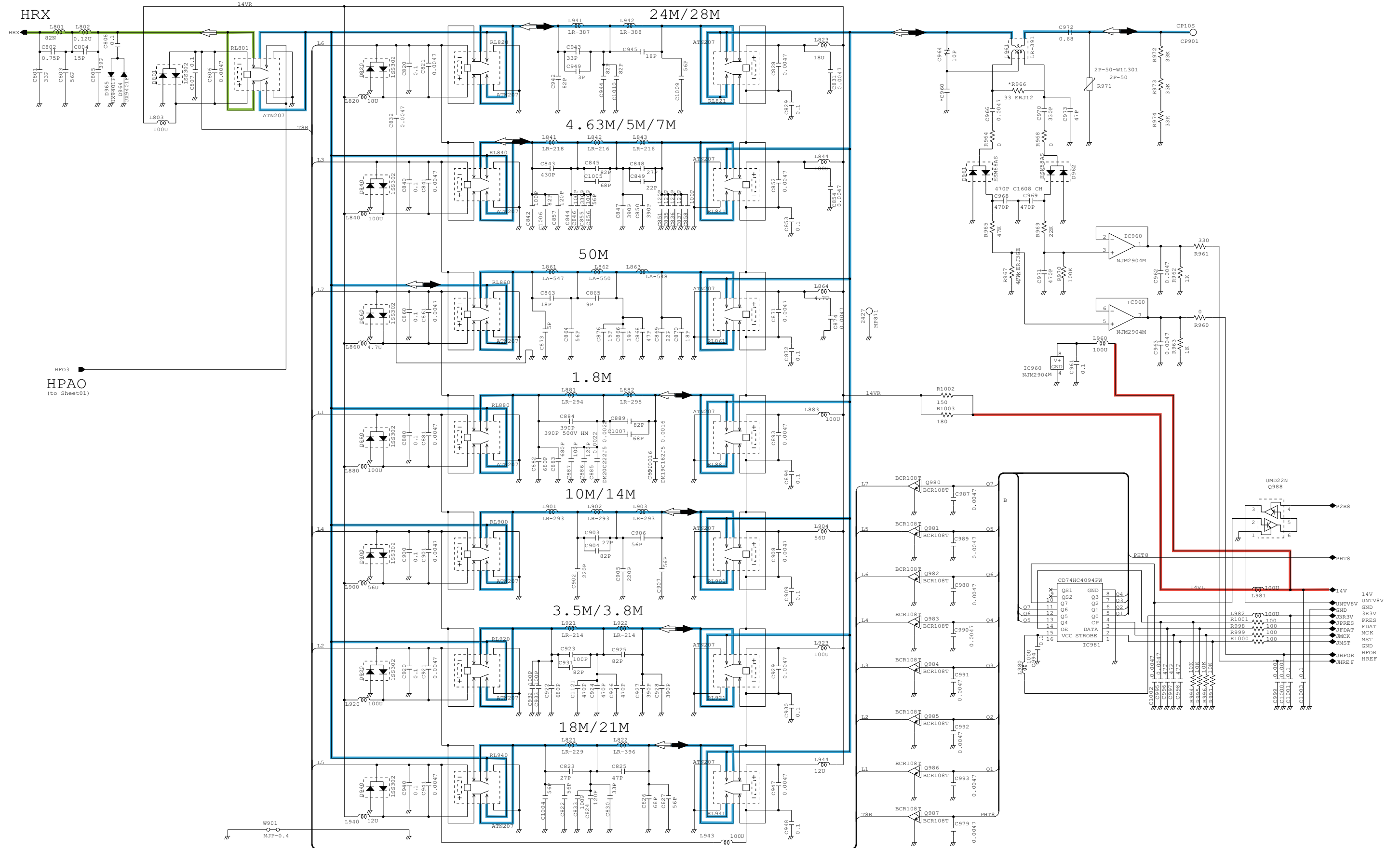

*; Refer to "PARTS LIST."

• DDS UNIT

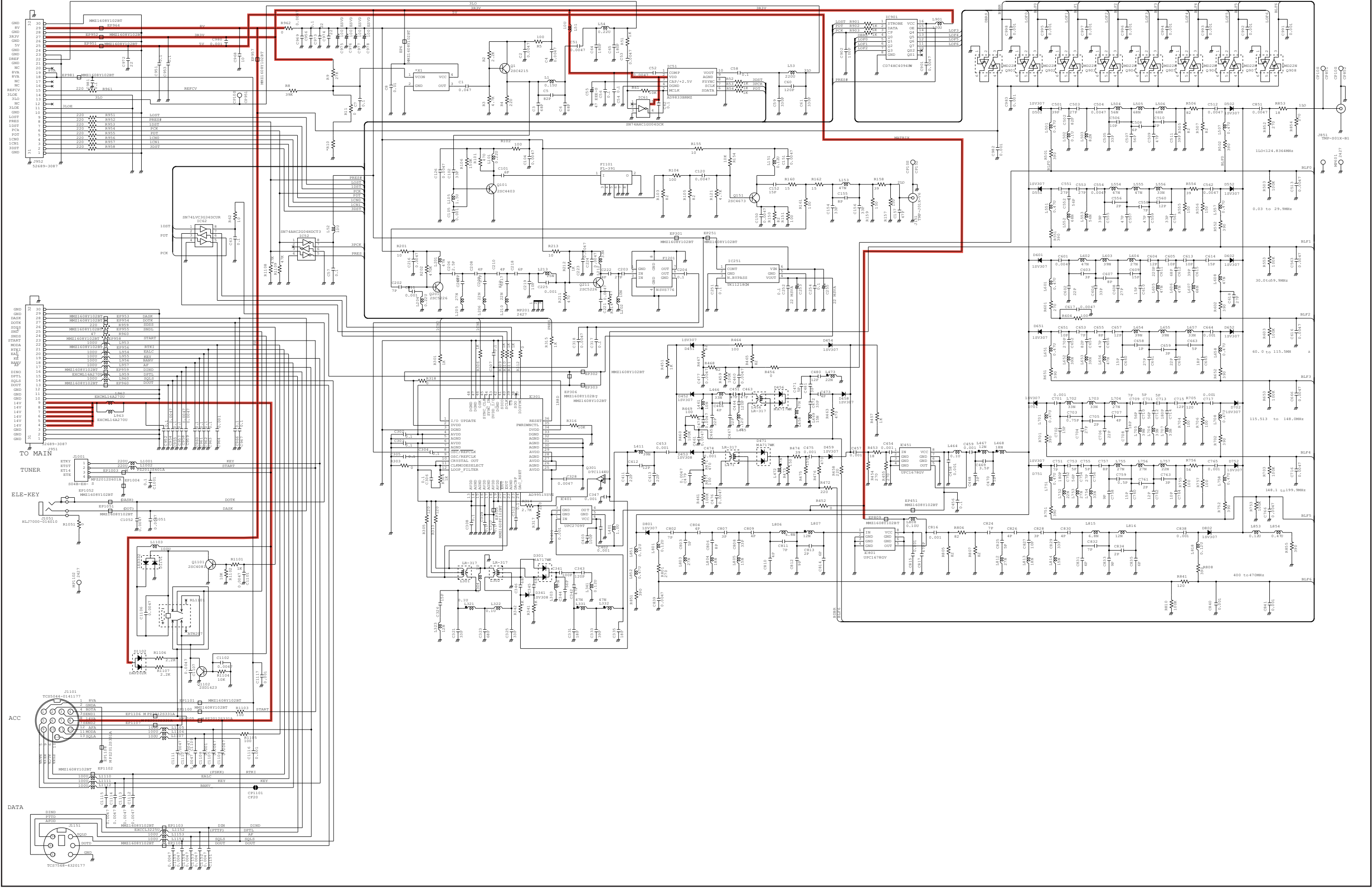

*; Refer to "PARTS LIST."



SERVICE MANUAL

HF/VHF/UHF ALL MODE TRANSCEIVER

IC-7000

S-14214HZ-C1
Dec. 2005

Icom Inc.

INTRODUCTION

This service manual describes the latest service information for the **IC-7000 HF/VHF/UHF ALL MODE TRANSCEIVER** at the time of publication.

VER.NO.	VERSION	SYMBOL
#02	Europe	EUR
#03	France	FRA
#04	Spain	ESP
#05	U.S.A.	USA
#08	Export	EXP
#10	United Kingdom	UK

To upgrade quality, all electrical or mechanical parts and internal circuits are subject to change without notice or obligation.

DANGER

NEVER connect the transceiver to an AC outlet or to a DC power supply that uses more than 16 V. Such a connection could cause a fire or electric hazard.

DO NOT expose the transceiver to rain, snow or any liquids.

DO NOT reverse the polarities of the power supply when connecting the transceiver.

DO NOT apply an RF signal of more than 20 dBm (100 mW) to the antenna connector. This could damage the transceiver's front end.



ORDERING PARTS

Be sure to include the following four points when ordering replacement parts:

1. 10-digit Icom parts number
2. Component name and informations
3. Equipment model name and unit name
4. Quantity required

<SAMPLE ORDER>

5030002820 LCD LTA025A161A IC-7000 Front unit 5 pieces
8810009610 Screw FH M2.6 × 6 ZK IC-7000 Top cover 10 pieces

Addresses are provided on the inside back cover for your convenience.

REPAIR NOTES

1. Make sure the problem is internal before disassembling the transceiver.
2. **DO NOT** open the transceiver until the transceiver is disconnected from its power source.
3. **DO NOT** force any of the variable components. Turn them slowly and smoothly.
4. **DO NOT** short any circuits or electronic parts. An insulated turning tool **MUST** be used for all adjustments.
5. **DO NOT** keep power ON for a long time when the transceiver is defective.
6. **DO NOT** transmit power into a signal generator or a sweep generator.
7. **ALWAYS** connect a 50 dB to 60 dB attenuator between the transceiver and a deviation meter or spectrum analyzer when using such test equipment.
8. **READ** the instructions of test equipment thoroughly before connecting equipment to the transceiver.

Icom, Icom Inc. and  ICOM logo are registered trademarks of Icom Incorporated (Japan) in the United States, the United Kingdom, Germany, France, Spain, Russia and/or other countries.

TABLE OF CONTENTS

SECTION 1	SPECIFICATIONS	
SECTION 2	INSIDE VIEWS	
SECTION 3	CIRCUIT DESCRIPITON	
3 - 1	RECEIVER CIRCUITS	3 - 1
3 - 2	TRANSMITTER CIRCUITS	3 - 4
3 - 3	DDS CIRCUITS	3 - 6
3 - 4	LOGIC CIRCUITS	3 - 8
3 - 5	POWER SUPPLY CIRCUITS	3 - 8
3 - 6	PORT ALLOCATIONS	3 - 9
SECTION 4	ADJUSTMENT PROCEDURES	
4 - 1	PREPARATION	4 - 1
4 - 2	DDS ADJUSTMENT	4 - 3
4 - 3	DISPLAY ADJUSTMENT	4 - 3
4 - 4	TRANSMITTER ADJUSTMENT	4 - 3
4 - 5	RECEIVER ADJUSTMENT	4 - 11
SECTION 5	PARTS LIST	
SECTION 6	MECHANICAL PARTS AND DISASSEMBLY	
SECTION 7	SEMI-CONDUCTOR INFORMATION	
SECTION 8	BOARD LAYOUTS	
8 - 1	DISPLAY UNIT	8 - 1
8 - 2	VR UNIT	8 - 1
8 - 3	MAIN UNIT	8 - 3
8 - 4	PA UNIT	8 - 5
8 - 5	DDS UNIT	8 - 7
8 - 6	LOGIC UNIT	8 - 9
8 - 7	CONNECT UNIT	8 - 11
8 - 8	DRIVER UNIT	8 - 11
8 - 9	HM-151	8 - 11
SECTION 9	WIRING DIAGRAM	
SECTION 10	BLOCK DIAGRAM	
SECTION 11	CIRCUIT DIAGRAMS	
11 - 1	DISPLAY/VR/CONNECT UNITS	11 - 1
11 - 2	MAIN UNIT	11 - 3
11 - 3	LOGIC UNIT	11 - 7
11 - 4	PA/DRIVER UNITS	11 - 10
11 - 5	DDS UNIT	11 - 13

SECTION 1 SPECIFICATIONS

GENERAL

- Frequency coverage :
 - Receive : 0.030 – 199.999999 MHz^{*1,*2}
400.000 – 470.000000 MHz^{*1,*2}
 - Transmit : 1.800 – 1.999999 MHz^{*2}
3.500 – 3.999999 MHz^{*2}
5.260 – 5.405000 MHz^{*2}
7.000 – 7.300000 MHz^{*2}
10.100 – 10.150000 MHz
14.000 – 14.350000 MHz
18.068 – 18.168000 MHz
21.000 – 21.450000 MHz
24.890 – 24.990000 MHz
28.000 – 29.700000 MHz
50.000 – 54.000000 MHz^{*2}
144.000 – 148.000000 MHz^{*2}
430.000 – 450.000000 MHz^{*2}
- *1 Some frequency bands are not guaranteed.
- *2 Depending on version.
- Mode : USB, LSB, CW, RTTY (FSK), AM, FM, WFM (WFM is for receiver only)
- Number of memory ch. : 503 (495 split, 6 scan edges, 2 call)
- Antenna connector : SO-239 × 2
(for HF/50 MHz and 144/430 MHz)/50 Ω
- Power supply requirement : 13.8 V DC ±15% (negative ground)
- Frequency stability : Less than ±0.5 ppm
(0°C to +50°C ; +32°F to +122°F)
- Current drain :
 - Transmit : at 100 W : 22 A
 - Receive : standby : 1.3 A
max. audio : 1.6 A
- Usable temperature range : -10°C to +60°C (+14°F to +140°F)
- Dimensions : 167(W) × 58(H) × 180(D) mm
(proj. not included) 6⁹/₁₆(W) × 2⁹/₃₂(H) × 7³/₃₂(D) inch
- Weight (approx.) : 2.3 kg (5 lb 1 oz)
- CI-V connectors : 2-conductor 3.5 (d) mm (1/8")
- Video connector : 2-conductor 3.5 (d) mm (1/8")
- ACC connector : 13-pin
- Data connector : 6-pin

TRANSMITTER

- Output power :

	SSB/CW/ RTTY/FM	AM
1.8–50 MHz bands	2–100 W	1–40 W
144 MHz band	2–50 W	2–20 W
430 MHz band	2–35 W	2–14 W
- Modulation system :
 - SSB : Digital PSN modulation
 - AM : Digital Low Power modulation
 - FM : Digital Phase modulation
- Spurious emissions :
 - below 30 MHz bands : Less than -50 dB
 - above 50 MHz bands : Less than -60 dB
- Carrier suppression : More than 50 dB
- Unwanted sideband : More than 50 dB
- Microphone connector : 8-pin modular jack (600 Ω)
- KEY connector : 3-conductor 6.35 (d) mm (1/4")
- RTTY connector : 3-conductor 3.5 (d) mm (1/8")

RECEIVER

- Receive system :
 - SSB/CW/AM/FM : Triple conversion superheterodyne
 - WFM : Double conversion superheterodyne

- Intermediate frequencies :

	1st IF	2nd IF	3rd IF
SSB/CW/AM/ RTTY/FM	124.487 MHz	455 kHz	16.15 kHz
WFM	134.732 MHz	10.700 MHz	—

- Receive sensitivity : (pre-amp ON)

	SSB/ CW/ RTTY	AM	FM	WFM
0.5–1.8 MHz	—	13 μV	—	—
1.8–28 MHz ^{*1}	0.15 μV	2.0 μV	—	—
28–29.995 MHz ^{*2}			0.5 μV	—
50 MHz band	0.12 μV	1.0 μV	0.25 μV	—
76–108 MHz	—	—	—	10 μV
144/430 MHz bands	0.11 μV	1.0 μV	0.18 μV	—

Note: SSB, CW and AM modes are measured at 10 dB S/N; FM mode at 12 dB SINAD.

*1 Except 4–4.5 MHz, 8–9 MHz.

*2 FM mode: 28–29.7 MHz

- Squelch Sensitivity : (pre-amp ON)
 - SSB : Less than 5.6 μV
 - FM : Less than 0.3 μV
- Selectivity : (Sharp filter is selected)
 - SSB (BW=2.4 kHz) : More than 2.4 kHz/-6 dB
Less than 3.6 kHz/-60 dB
 - CW (BW=500 Hz) : More than 500 Hz/-6 dB
Less than 900 Hz/-60 dB
 - RTTY (BW=350 Hz) : More than 360 kHz/-6 dB
Less than 650 kHz/-60 dB
 - AM (BW=6 kHz) : More than 6.0 kHz/-6 dB
Less than 15 kHz/-60 dB
 - FM (BW=15 kHz) : More than 12 kHz/-6 dB
Less than 20 kHz/-60 dB
- Spurious and image rejection ratio:
 - HF bands : More than 70 dB
 - 50 MHz band : More than 70 dB (except IF/2 through)
 - 144/430 MHz bands : More than 65 dB
(except 144 MHz band IF through)
- Audio output power : More than 2.0 W at 10% distortion
(at 13.8 V DC) with an 8 Ω load
- RIT variable range : ±9.99 kHz
- PHONES connector : 3-conductor 3.5 (d) mm (1/8")/8 Ω
- EXT SP connector : 2-conductor 3.5 (d) mm (1/8")/8 Ω

SECTION 2 INSIDE VIEWS

• TOP VIEW

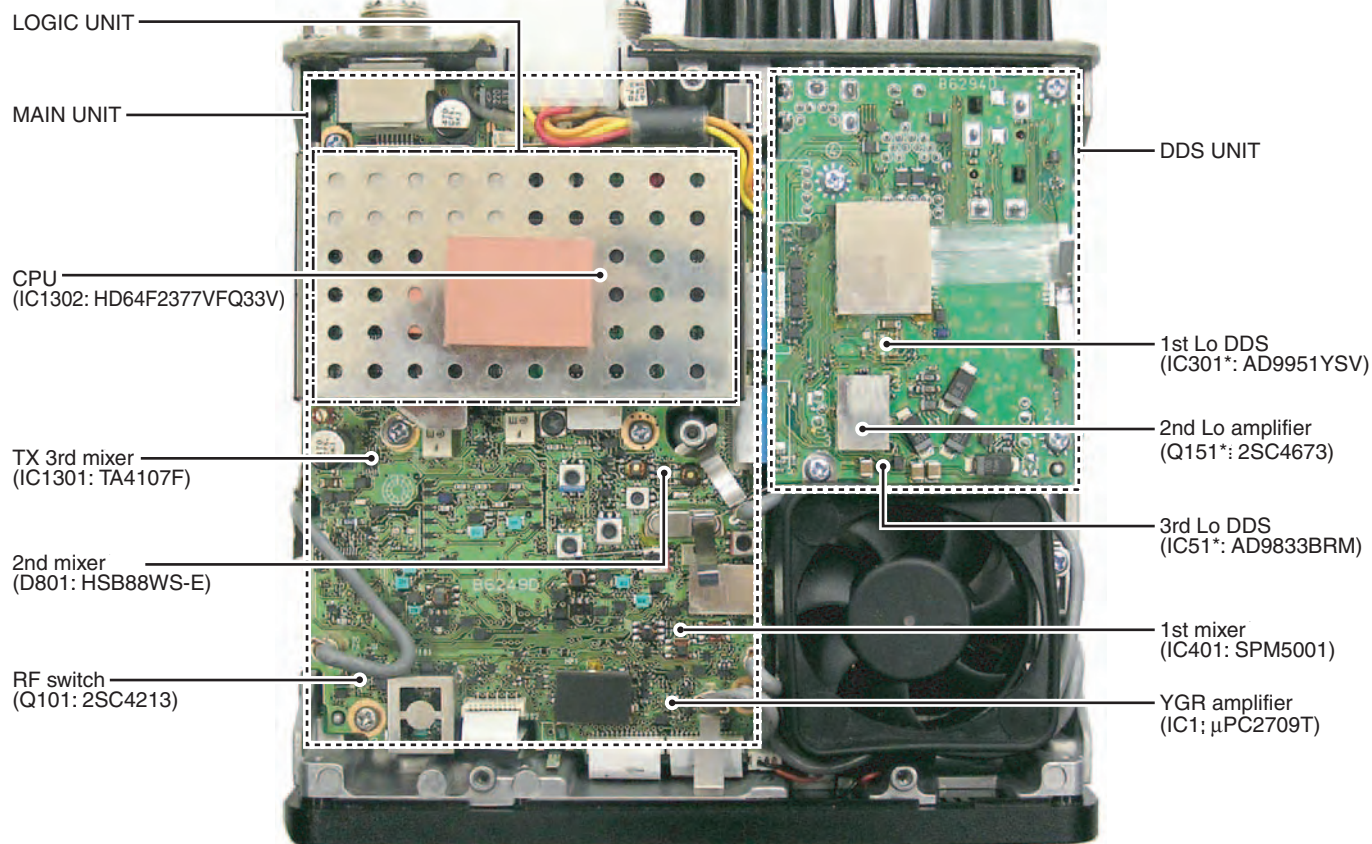

• BOTTOM VIEW

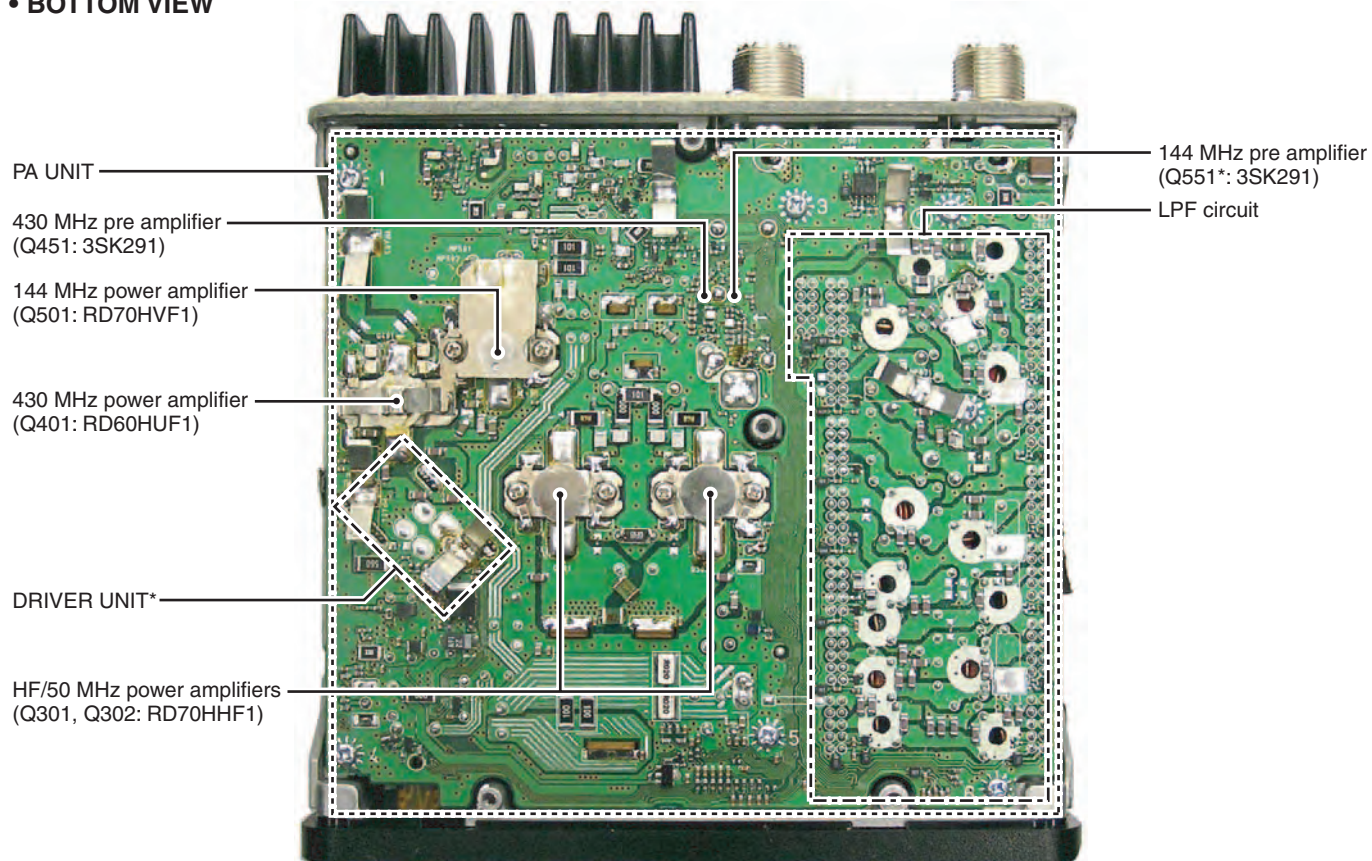

*Located under side of the point

SECTION 3 CIRCUIT DESCRIPTION

3-1 RECEIVER CIRCUITS

3-1-1 HF/50 MHz RF CIRCUIT (MAIN AND PA UNITS)

The HF/50 MHz RF filters pass only the desired band signals and suppress undesired band signals. The HF/50 MHz RF circuit has 7 low-pass and 5 high-pass filters for specified band use.

The HF/50 MHz RF signals from the [ANT1] connector, pass through one of 7 low-pass filters as below, the TX/RX switch (PA unit; RL801), low-pass filter (PA unit; L801, L802, C801–C805) and band switch (D151), and are then applied to the MAIN unit via J101 (MAIN unit).

• Used RF low-pass filter (PA unit)

Frequency (MHz)	Control signal	Entrance relay	Frequency (MHz)	Control signal	Entrance relay
0.03–2 MHz	L1	RL881	15–22 MHz	L5	RL941
2–4 MHz	L2	RL921	22–30 MHz	L6	RL821
4–8 MHz	L3	RL841	30–60 MHz	L7	RL861
8–15 MHz	L4	RL901			

The signals from the PA unit are applied to the RF switch (Q101) via the band switch (D113) and then passed through the 20 dB attenuator (D101, D102).

The signals below 1.8 MHz are passed through the low-pass filter (L103, L104, C106, C110, C111) and then applied to the preamplifier circuit.

The other band signals (1.8–60 MHz) are passed through the high-pass filter (L105, L109, L110, L116, L117, C108, C109, C114–C116) to suppress strong signals below 1.8 MHz and then applied to the low-pass and high-pass filter circuits.

(1) 1.8–2 MHz

The filtered signals from the high-pass filter are passed through the low-pass filter (L205, L207, C209–C213) and then applied to the preamplifier circuits.

(2) 2–30 MHz

The filtered signals from the high-pass filter are applied to one of 5 high-pass filters as at right above after passed through the low-pass filter (L205, L207, C209–C213) and are then applied to the preamplifier circuit.

• Used RF high-pass filter (MAIN unit)

Frequency (MHz)	Control signal	Entrance diode	Frequency (MHz)	Control signal	Entrance diode
1.8–2 MHz	B1	D204	13.9–20.9 MHz	B5	D210
2–3.4 MHz	B2	D205	20.9–30 MHz	B6	D211
3.4–6.9 MHz	B3	D208	30–60 MHz	B7	D212
6.9–13.9 MHz	B4	D209			

(3) 30–60 MHz

The filtered signals from the high-pass filter are passed through another high-pass filter (L215, L217, C228, C229, C237, C238) and then amplified at the RF amplifier (Q211).

The amplified signals are applied to the preamplifier circuit.

3-1-2 VHF AND UHF RF CIRCUITS (PA UNIT)

The VHF and UHF RF circuits filter and amplify only the desired band signals and suppress undesired band signals. The both RF circuits have preamplifiers and bandpass filters.

• VHF RF CIRCUIT

The VHF RF signals from the [ANT2] connector pass through the low-pass filters (L506, L508, L510, L601–L603, C516, C519, C521, C601, C602) and antenna switching circuit (D507–D509). The switched signals are passed through the attenuator (D551, D552) and bandpass filter (D553, D554, D556). The filtered signals are applied to the preamplifier (Q551) and then passed through another bandpass filter (D558–D560).

The filtered signals are passed through the band switch (D462) and then applied to the 1st mixer circuit (MAIN unit) via J101 (MAIN unit).

• UHF RF CIRCUIT

The UHF RF signals from the [ANT2] connector pass through the low-pass (L601–L603, C601, C602) and high-pass (L413, L414, C428, C429, C431, C433) filters and then applied to the antenna switching circuit (D408–D410). The switched signals are passed through the attenuator (D451, D452) and then amplified at the preamplifier (Q451) between the 2 bandpass filters (D453–D456). The filtered signals are amplified at another preamplifier (IC471, pins 1, 4).

• RECEIVER CONSTRUCTION

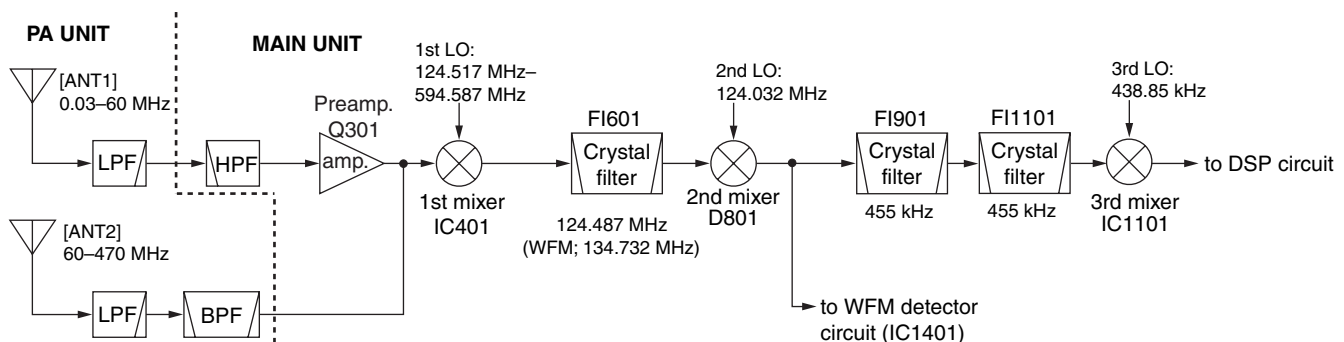

The amplified signals are passed through the band switch (D461) and then applied to the 1st mixer circuit (MAIN unit) via J101 (MAIN unit).

D453–D456, D553, D554, D556 and D558–D560 are varactor diodes that tune the center frequency of an RF passband for wide bandwidth receiving and good image response rejection.

When receiving the signals, higher than 129 MHz, are received, the switching diodes (D555, D557) are turned off by the control signal “2MBL” from the CPU (LOGIC unit; IC1302) via Q2150, then the varactor diodes (D556, D558) are disconnected to shift the filtering frequencies.

3-1-3 PREAMPLIFIER CIRCUIT (MAIN UNIT)

The preamplifier circuit amplifies received RF signals for wide band frequency range.

When the preamplifier is turned ON, the RF signals (HF/50 MHz bands) from the high-pass filters are applied to the preamplifier (Q301) via the preamplifier switches (D301, D302).

When the preamplifier is turned OFF, the RF signals (HF/50 MHz bands) are passed through the bypass switches (D301, D303).

The amplified or bypassed signals are applied to the 1st mixer circuit (IC401).

3-1-4 1ST MIXER CIRCUIT (MAIN UNIT)

The 1st mixer circuit mixes the received RF signals with the 1st LO signal to convert the receive signal frequencies to the 1st IF frequency.

While receiving the HF/50 MHz bands signals, the amplified signals from the preamplifier switch (D304) or the bypassed signals from the bypass switch (D303) are passed through the low-pass filter (L310, L312, C314, C316, C318, C320, C322) and then applied to the 1st mixer circuit (IC401) via the band switch (D305).

While receiving the VHF/UHF bands signals, the signals from the VHF/UHF RF circuit (PA unit) are passed through the low-pass filter (L309, L311, L313, C313, C315, C317, C319, C321, C323, C325) and then applied to the 1st mixer circuit (IC401) via the band switch (D306).

The applied signals are mixed with the 1st LO signal (124.517–594.487 MHz) and convert into the 1st IF signal.

The 1st LO signal is generated in the DDS unit, and applied to the 1st mixer circuit (IC401, pins 1, 6) after being amplified and attenuated at the 1st LO amplifier (IC421, pins 1, 4) and the attenuators (R416–R418, R421–R423), respectively.

The converted 1st IF signal is applied to the 1st IF circuit.

3-1-5 1ST IF CIRCUIT (MAIN UNIT)

The 1st IF circuit filters and amplifies the 1st IF signal.

The converted 1st IF signal is applied to the IF amplifier (Q502) via RX switches (D502, D505).

• 1st IF frequency	
Mode	1st IF
USB	124.48850 MHz
LSB	124.48550 MHz
CW	124.48700 MHz
RTTY	124.48683 MHz
AM/FM	124.48700 MHz
WFM	134.73200 MHz

The 124.487 MHz 1st IF signal (except WFM mode) passes through the crystal filter (FI601) via the mode switches (D602, D604), and the 134.732 MHz 1st IF signal (WFM mode) passes through the bandpass filter (L607, L609, C602, C606, C608–C610, C617, C618) via the mode switches (D601, D603) to suppress out-of-band signals.

Then the filtered signal is applied to the IF amplifier (Q702) and then applied to the 2nd mixer circuit (D801) via the RX switches (D702, D704).

3-1-6 2ND MIXER CIRCUIT (MAIN UNIT)

The 2nd mixer circuit mixes the 1st IF signal with the 2nd LO signal to convert into the 2nd IF frequency.

The amplified signal from the IF amplifier (Q702) is applied to the 2nd mixer circuit (D801) and then mixed with the 2nd LO signal (124.032 MHz) to convert into the 455 kHz (other than WFM) or 10.7 MHz (WFM) 2nd IF signal.

The 2nd LO signal is generated in the DDS unit, and applied to the 2nd mixer circuit (D801) after being filtered and attenuated at the low-pass filter (L808, C816, C817) and the attenuators (R801, R805, R806, R809–R811), respectively.

The converted 2nd IF signal is applied to the 2nd IF circuit.

3-1-7 2ND IF CIRCUIT (MAIN UNIT)

The 2nd IF circuit amplifies and filters the 2nd IF signal.

The converted 2nd IF signal is applied to the bandpass filter (FI901) to suppress undesired signals.

The 455 kHz 2nd IF signal (except WFM mode) is passed through the bandpass filter (FI901) via the mode switch (D803) and then amplified at the IF amplifier (Q902). The amplified signal is passed through the bandpass filter (FI1001) and then applied to another IF amplifier (Q1001).

• 2nd IF frequency	
Mode	2nd IF
USB	456.500 kHz
LSB	453.500 kHz
CW	455.000 kHz
RTTY	454.830 kHz
AM/FM	455.000 kHz
WFM	10.700 MHz

The amplified signal is applied to the 3rd mixer circuit.

The 10.7 MHz 2nd IF signal for WFM mode is passed through the low-pass filter (L1402, C1402–C1404) via the mode switch (D802) and then applied to the IF amplifier (Q1401). The amplified signal is passed through the bandpass filter (FI1401) and then applied another IF amplifier (Q1402).

The amplified IF signal is passed through the bandpass filter (FI1402) and then applied to the WFM demodulator circuit (IC1401).

3-1-8 3RD MIXER CIRCUIT (MAIN UNIT)

The 3rd mixer circuit mixes the 2nd IF signal with the 3rd LO signal to convert into the 3rd IF frequency.

The amplified signal from the IF amplifier (Q1001) are mixed with the 3rd LO signal (438.85 kHz), where come from the DDS unit via J2406, at the 3rd mixer circuit (IC1101) to convert into the 16.15 kHz 3rd IF signal.

The converted 3rd IF signal is applied to the 3rd IF circuit.

3-1-9 3RD IF CIRCUIT (MAIN UNIT)

The 3rd IF circuit filters and amplifies the 3rd IF signal.

The converted 3rd IF signal is amplified at the 3rd IF amplifier (IC1203, pins 5, 7) and then passed through the low-pass filter (IC1203, pins 1, 3). The filtered signal is passed through the mode switches (IC1201, pins 1, 7; IC1202, pins 1, 7) and then applied to the analog switch (IC1256, pins 11, 13).

The switched signal is applied to the DSP circuit (LOGIC unit) via the J2251 (pin 1).

3-1-10 DEMODULATOR CIRCUITS (MAIN UNIT)

• WFM mode

The demodulator circuit converts the 2nd IF signal into the AF signals.

The filtered signal from the bandpass filter (FI1402) is applied to the IF amplifier section inside the WFM demodulator (IC1401, pin 1) and then applied to the quadrature detector section to convert into AF signals. The detected AF signals are output from pin 6 (IC1401) and then applied to the mode switches (IC1201, pins 1, 7; IC1202, pins 1, 6).

The switched AF signals are applied to the analog switch (IC1256, pins 11, 13) and then applied to the DSP circuit (LOGIC unit) via J2251 (pin 1).

• DSP CIRCUIT

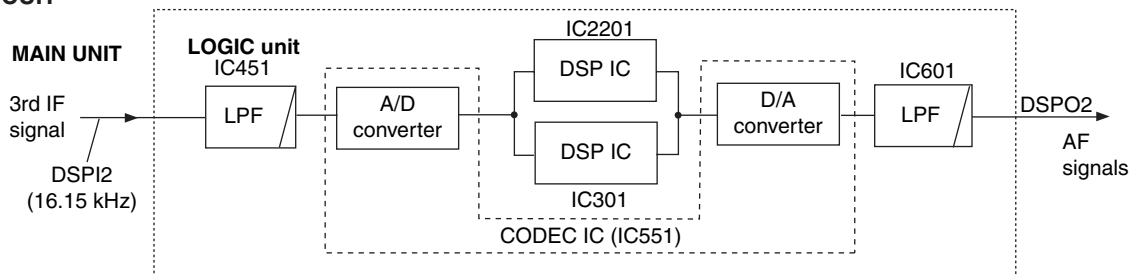

• AF CIRCUIT

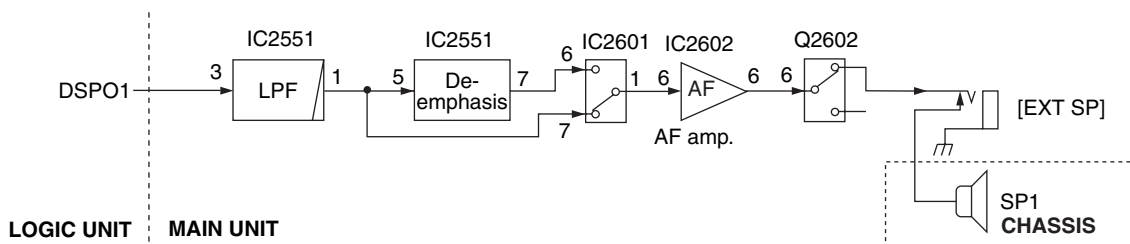

3-1-11 DSP CIRCUIT (LOGIC UNIT)

The DSP (Digital Signal Processor) circuit enables digital IF filter, manual notch, digital twin PBT and phase demodulation, etc.

The 3rd IF or demodulated AF (WFM mode) signals are passed through the low-pass filter (IC451, pins 1, 2) and then applied to the A/D converter (IC551, pin 4). The converted signals are applied to the DSP ICs (IC301, IC2201) for the digital IF filter, demodulation, automatic notch and noise reduction, etc.

The output digital audio signals from the DSP IC (IC301) are applied to the D/A converter (IC551) to convert into the analog audio signals.

The converted audio signals from the D/A converter (IC551, pins 25, 26) are passed through the low-pass filter (IC601, pins 5-7), and then applied to the AF amplifier circuit (MAIN unit) via J701 (pin 14).

3-1-12 AF AMPLIFIER CIRCUIT (MAIN UNIT)

The AF amplifier amplifies the demodulated AF signals to drive speaker.

The filtered signal from the low-pass filter (LOGIC unit; IC601, pins 5-7) are passed through another low-pass filter (IC2551, pins 1, 3).

While in FM mode, the filtered AF signals from the low-pass filter (IC2551, pin 1) are applied to the de-emphasis circuit (IC2551, pins 5-7) to obtain the -6 dB/octave characteristics and then applied to the AF switch (IC2601, pins 1, 6).

While except FM mode, the filtered AF signals from low-pass filter (IC2551, pin 1) are applied to the AF switch (IC2601, pins 1, 7).

The switched AF signals are amplified at the AF power amplifier (IC2602, pins 1, 4) and then applied to the speaker switch (Q2602).

The switched signal is applied to the internal speaker that is connected to J2601 via [EXT SP] jack (J2602).

3-1-13 AGC CIRCUIT (MAIN UNIT)

The AGC (Automatic Gain Control) circuit adjusts IF amplifier gain to keep the audio output at a constant level. The receiver gain is determined by the voltage on the AGC line from the DSP circuit.

The AGC voltage is detected at the AGC detector section inside the DSP ICs (LOGIC unit; IC301, IC2201) and the AGC voltage is applied to the D/A converter (IC2155). The converted AGC voltage is applied to the IF amplifiers (Q702, Q902, Q1001) after being amplified at IC2101 (pin 12) and sets the receiver gain with [RF/SQL] control.

When receiving strong signals, the detected voltage increases and the AGC voltage decreases. As the AGC voltage is used for the bias voltage of the IF amplifiers (Q702, Q902, Q1001), IF amplifier gain is decreased.

3-1-14 S-METER CIRCUIT (LOGIC UNIT)

The S-meter circuit indicates the relative received signal strength while receiving.

The received signal strength is detected inside the DSP ICs (IC301, IC2201) and then applied to the main CPU (IC1302).

The S-meter signal for WFM mode is output from the FM detector IC (IC401, pin 4) and then applied to the main CPU (IC1302, pin 123).

The S-meter signal from the main CPU (IC1302) is applied to the sub CPU (DISPLAY unit; IC2003) and is then displayed on the LCD display.

3-1-15 SQUELCH CIRCUIT (MAIN UNIT)

The squelch circuit mutes audio output when the S-meter signal is lower than the [RF/SQL] control setting level.

The S-meter signal from the DSP IC is applied to the main CPU (LOGIC unit; IC1302) and is compared with the threshold level set by the [RF/SQL] control. The [RF/SQL] setting is picked up at the sub CPU (DISPLAY unit; IC2003, pin 74). The main CPU (LOGIC unit; IC1302) compares the S-meter signal and [RF/SQL] setting, and outputs the mute signal via the DSP IC (IC301, pin B4) to the AF switch (IC2601, pin 2) to cut AF signals via Q2607.

While receiving WFM mode, the S-meter signal is output from the WFM demodulator (IC401, pin 4) and applied to the main CPU (LOGIC unit; IC1302, pin 123). The main CPU (LOGIC unit; IC1302) compares the S-meter signal and [RF/SQL] setting, and outputs the mute signal via the DSP IC (IC301, pin B4) to the AF switch (IC2601, pin 2) to cut AF signals via Q2607.

• AGC CIRCUIT

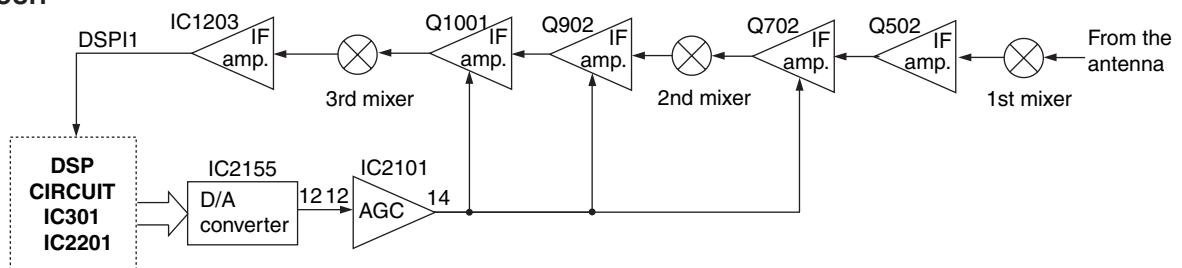

3-2 TRANSMITTER CIRCUITS

3-2-1 MICROPHONE AMPLIFIER CIRCUIT (MAIN UNIT)

The microphone amplifier circuit amplifies microphone audio signal to a level needed for the DSP circuit.

Audio signals from the [MIC] connector (FRONT unit; J303 or MAIN unit; J2003) are amplified at the microphone amplifier (IC2007, pins 1, 2) and then applied to the DSP circuit (LOGIC unit) via J2251 (pin 3).

3-2-2 DSP CIRCUIT (LOGIC UNIT)

The DSP (Digital Signal Processor) circuit enables digital PSN modulator, digital Low Power modulator, digital Phase modulator, transmitter monitor and side tone, etc.

The amplified microphone signals are passed through the low-pass filter (IC502, pins 1, 2) and then applied to the A/D converter (IC551, pin 3). The converted digital audio signal are applied to the DSP ICs (IC301, IC2201) to convert into the modulated 16.15 kHz 3rd IF signal. The modulated 3rd IF signal from the DSP IC (IC301) is applied to the D/A converter (IC551) to convert into the analog 3rd IF signal. The converted analog 3rd IF signal is output from pins 27, 28 (IC551) and then passed through the low-pass filter (IC601, pins 1-3).

The filtered IF signal is applied to the 3rd mixer circuit (MAIN unit) via the J701 (pin 12).

3-2-3 3RD MIXER CIRCUIT (MAIN UNIT)

The 3rd mixer circuit mixes the 3rd IF signal with the 3rd LO signal to convert into the 2nd IF frequency.

The filtered signal from the low-pass filter (LOGIC unit; IC601) is applied to the analog switch (IC2251, pins 1, 7) and then applied to the 3rd mixer circuit (IC1301, pins 3, 5). The applied signal is mixed with the 3rd LO signal (438.85 kHz) coming from DDS unit via J2406 (pin 13) and converted into the 455 kHz 2nd IF signal.

The converted 2nd IF signal is applied to the 2nd IF circuit.

3-2-4 2ND IF CIRCUIT (MAIN UNIT)

The 2nd IF circuit filters and amplifies the 2nd IF signal.

The converted 2nd IF signal is applied to the 2nd IF amplifier (Q901) and then passed through the bandpass filter (FI901) via the TX switch (D903) to suppress unwanted signals.

The filtered signal is applied to the 2nd mixer circuit.

3-2-5 2ND MIXER CIRCUIT (MAIN UNIT)

The 2nd mixer circuit mixes the 2nd IF signal with the 2nd LO signal to convert into the 1st IF frequency.

The filtered signal from the bandpass filter (FI901) is applied to the 2nd mixer circuit (D801) and mixed with 2nd LO signal (124.032 MHz) to convert into the 1st IF signal.

The 2nd LO signal is generated in the DDS unit, and applied to the 2nd mixer circuit (D801) after being filtered and attenuated at the low-pass filter (L808, C816, C817) and the attenuators (R801, R805, R806, R809–R811), respectively.

The converted 1st IF signal is applied to the 1st IF circuit.

3-2-6 1ST IF CIRCUIT (MAIN UNIT)

The 1st IF circuit amplifies and filters the 1st IF signal.

The converted 1st IF signal is applied to the IF amplifier (Q701) via the TX switch (D703) and then passed through the bandpass filter (FI601) to suppress unwanted signals via the filter switches (D601, D602).

The filtered signals are applied to the 1st mixer circuit.

3-2-7 1ST MIXER CIRCUIT (MAIN UNIT)

The 1st mixer circuit mixes the 1st IF signal with the 1st LO signal to convert into the RF frequency.

The filtered signal is applied to the 1st mixer circuit (IC401) via the TX switches (D501, D504) and mixed with the 1st LO signal (124.517–594.487 MHz) to convert into the RF signal.

The 1st LO signal is generated in the DDS unit, and applied to the 1st mixer circuit (IC401, pins 1, 6) after being amplified and attenuated at the 1st LO amplifier (IC421, pins 1, 4) and the attenuators (R416–R418, R421–R423), respectively.

The converted RF signal is applied to the RF circuit.

3-2-8 RF CIRCUIT (MAIN UNIT)

The RF circuit amplifies and filters the RF signal from the 1st mixer circuit.

The HF/50 MHz bands signal from the 1st mixer circuit (IC401) is passed through the low-pass filter (L310, L312, C314, C316, C318, C320, C322) via the band switch (D305).

The HF band signal is passed through one of 5 high-pass (Refer to 3-1 for used RF high-pass filter) and low-pass (L205, L207, C209–C213) filters.

The 50 MHz band signal is passed through the bandpass filter (L219, L220, L246–L248, C240–C242, C282, C285–C291).

The filtered HF/50 MHz bands signal is amplified at the YGR amplifier (IC1) after passed through the high-pass filter (L109, L110, L116, L117, C109, C114–C116) and attenuator (R5–R7).

The amplified HF/50 MHz bands signal is applied to the drive and power amplifier circuits (PA unit) via J1.

The VHF/UHF bands signal from the 1st mixer circuit (IC401) is passed through the low-pass filter (L309, L311, L313, C313, C315, C317, C319, C321, C323, C325) via the band switch (D306).

The VHF band signal is passed through the bandpass filter (L8, L10–L13, C18, C25, C26, C28, C29, C31–C33) via the band switches (D3, D10) and then amplified at the RF amplifier (IC2, pins 1, 3). The amplified signal is passed through the band switch (D1) and attenuator (R5–R7), and then applied to the YGR amplifier (IC1, pins 1, 4).

The amplified signal is passed through the high pass filter (L21, C50–C52) via the filter switches (D6, D8) and then applied to the drive and power amplifier circuits (PA unit) via J1.

The UHF band signal is amplified at the RF amplifier (IC3, pins 1, 3) via the band switch (D4) and passed through the bandpass filters (FI2, FI3). The filtered signal is amplified at the YGR amplifier (IC1, pins 1, 4) after passed through the band switch (D2), attenuator (R5–R7) and bypass switches (D7, D9).

The amplified signal is applied to the drive and power amplifier circuits (PA unit) via J1.

• TRANSMITTER CONSTRUCTION

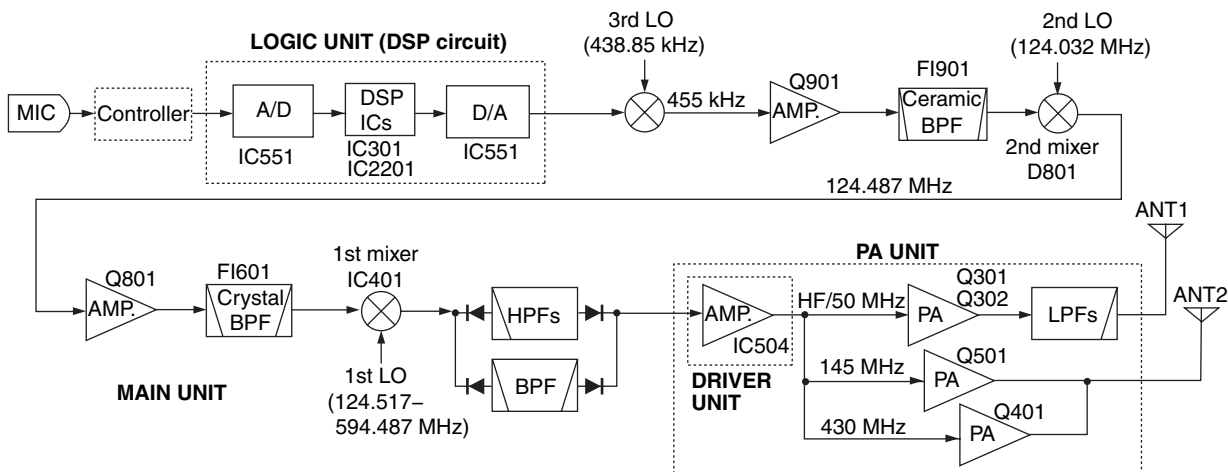

3-2-9 DRIVE AND POWER AMPLIFIER CIRCUITS (PA AND DRIVER UNITS)

The drive and power amplifier circuits amplify the RF signal from the RF circuit (MAIN unit) to obtain 100 W of RF output power for the HF/50 MHz bands, 50 W for the VHF band and 35 W for the UHF band.

The RF signal from the MAIN unit is applied to the pre drive amplifiers (PA unit; Q101, Q102) after passed through the attenuator (PA unit; R101–R103). The amplified signal is applied to the drive amplifier (DRIVER unit; Q504) to amplify a level needed for the power amplifiers.

The amplified HF/50 MHz bands signal from the drive amplifier is amplified at the power amplifiers (PA unit; Q301, Q302) to obtain a stable 100 W of RF output power. The power amplified signal is passed through the TX/RX switch (RL801), one of the 7 low-pass filters, APC detector (PA unit; D961, D962) and then applied to the [ANT1] connector (CHASSIS; J1).

The amplified VHF RF signal from the drive amplifier is amplified at the power amplifier (Q501) to obtain a stable 50 W of RF output power. The power amplified signals are applied to the low-pass filter, APC detector (D501–D504), TX/RX switch (D506, D510), low-pass filters (L506, L508, L510, L601–L603, C516, C519, C521, C601, C602) and [ANT2] connector (CHASSIS; J2).

The amplified UHF RF signal from the drive amplifier is amplified at the power amplifier (Q401) to obtain a stable 35 W of RF output power. The power amplified signal is applied to the low-pass filter, APC detector (D401–D404), TX/RX switch (D406, D407), high-pass filter (L413, L414, C428, C429, C431, C433), low-pass filter (L601–L603, C601, C602) and [ANT2] connector (CHASSIS; J2).

3-2-10 ALC CIRCUIT (MAIN UNIT)

The ALC (Automatic Level Control) circuit reduces the gain of IF amplifiers in order for the transceiver to output a constant RF power set by the RF power setting even when the supplied voltage shifts, etc.

The HF/50 MHz power amplified signal from the power amplifiers (PA unit; Q301, Q302) is detected at the APC detector (PA unit; D961). The detected voltage is applied to the buffer amplifier (PA unit; IC960, pins 5, 7) and then applied to the MAIN unit as the "HFOR" voltage.

The VHF and UHF RF power amplified signal from the power amplifiers (PA unit; Q401, Q501) are detected at the APC detectors (PA unit; D401, D404, D501, D504) respectively. The detected voltages ("VFOR" and "UFOR") are combined to "VUFOR" voltage and then applied to the MAIN unit.

The "HFOR" and "VUFOR" voltages are combined to the "FORL" voltage and then applied to the ALC amplifier (IC1601, pins 1, 2). The "POCV" voltage from the D/A converter (IC2155, pin 19) via the buffer amplifier (IC2101, pins 5, 7), determined by the RF power setting, is applied to the ALC amplifier (IC1601, pin 3) as the reference voltage.

When the "FORL" voltage exceeds the "POCV" voltage, ALC bias voltage from IC1601 (pin 1) controls the IF amplifiers (Q701, Q901). This adjusts the output power to the level determined by the RF power setting until the "FORL" and "POCV" voltages are equalized.

In AM mode, IC1601 functions as an averaging ALC amplifier with Q1601. The AM switch (Q1602) is turn ON and shifts the "POCV" voltage to adjust the TX output power for the AM mode (maximum; 40 W for HF/50 MHz bands, 20 W for VHF band, 14 W for UHF band).

The ALC bias voltage from IC1601 is also applied to the main CPU (LOGIC unit; IC1302, pin 115) as the "ALCL" voltage for ALC meter indication.

The external ALC input (negative voltage) from the [ACC] socket (pin 6) is converted to a positive voltage at D1609 and is applied to the buffer amplifier (Q1604). External ALC operation is identical to that of the internal ALC.

3-2-11 APC CIRCUIT (MAIN UNIT)

The APC (Automatic Power Control) circuit protects the power amplifiers on the PA unit from high SWR and excessive current.

The reflected wave signal appears and increases on the antenna connector when the antenna is mismatched.

The HF/50 MHz reflected signal level is detected at D962 (PA unit), and is amplified at the buffer amplifier (PA unit; IC960, pins 1, 3) and applied to the ALC amplifier (IC1601, pins 8, 9) as the "HREF" voltage.

• ALC CIRCUIT

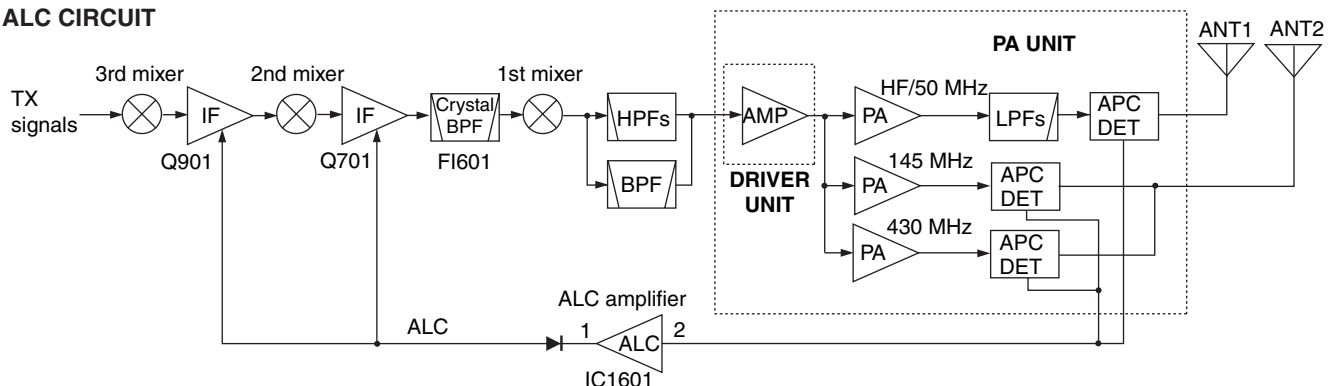

The VHF/UHF APC detector circuits (PA unit; D501, D504, D401, D404) detect the forward and reflection signals and convert into DC voltages. The converted DC voltages are combined and applied to the ALC amplifier (pins 1, 2) as "VUFOR" voltage.

For the current APC, the driving current at the power amplifiers is detected in the voltages ("ICH" and "ICL") which appear at both terminals of detector resistors (PA unit; R721, R722). The detected voltages are applied to the APC amplifier (IC1601, pins 5–7).

When the current of the power amplifier exceeds 22 A, The output voltage from the APC amplifier (IC1601, pin 7) controls the ALC line to prevent excessive current flow.

3-2-12 RF, ALC, SWR METER CIRCUITS (LOGIC UNIT)

While transmitting, RF, ALC or SWR meter readings are available and can be selected with the [F3 (MET)] switch.

(1) Power meter

The "FOR," "VFOR" and "UFOR" voltages are combined to the "FORL" voltage, and it is then applied to the main CPU (IC1302, pin 113) for indicating the TX output power.

(2) ALC meter

The ALC bias voltage from the buffer amplifier (MAIN unit; IC1601, pin 14) is applied to the main CPU (IC1302, pin 115) via the "ALCL" signal line for indicating the ALC level.

(3) SWR meter

The "FORL" and "REFL" voltages are applied to the main CPU (IC1302, pins 113, 114) respectively. The main CPU compares the ratio of "FORL" to "REFL" voltage and indicates the SWR for the [ANT1] connector.

3-3 DDS CIRCUITS

3-3-1 GENERAL

The DDS unit generates a 1st LO (124.517–594.487 MHz), a 2nd LO (124.032 MHz) and a 3rd LO (438.85 kHz) frequencies.

3-3-2 1ST LO CIRCUIT (DDS UNIT)

The 1st LO circuit generates a 1st LO signal based on the system clock that is tripled the 2nd LO frequency.

The 124.032 MHz 2nd LO signal is applied to the tripler circuit (Q201) and then passed through the high-pass filter (L205, L206, L210, C206–C210, C217–C219). The filtered signal is amplified at Q211 and then passed through the bandpass filter (FI201). The filtered signal is applied to the DDS IC (IC301) as the 372.096 MHz system clock. The DDS IC generates 38.62189–199.999999 MHz frequency based on the system clock. The output signal from the DDS IC (IC301, pins 20, 21) is applied to the doubler circuit (D301) and then amplified at IC401 (pins 1, 4) after being passed through the low-pass filter (L331, L332, C331, C332, C335). The amplified signal is applied to one of the multiplier circuits which is selected from the readout frequency and then amplified at IC451 (pins 1, 5). The amplified signal is passed through the bandpass filters.

The filtered signal is applied to the 1st mixer circuit (MAIN unit) via J851.

• FREQUENCY CONSTRUCTION

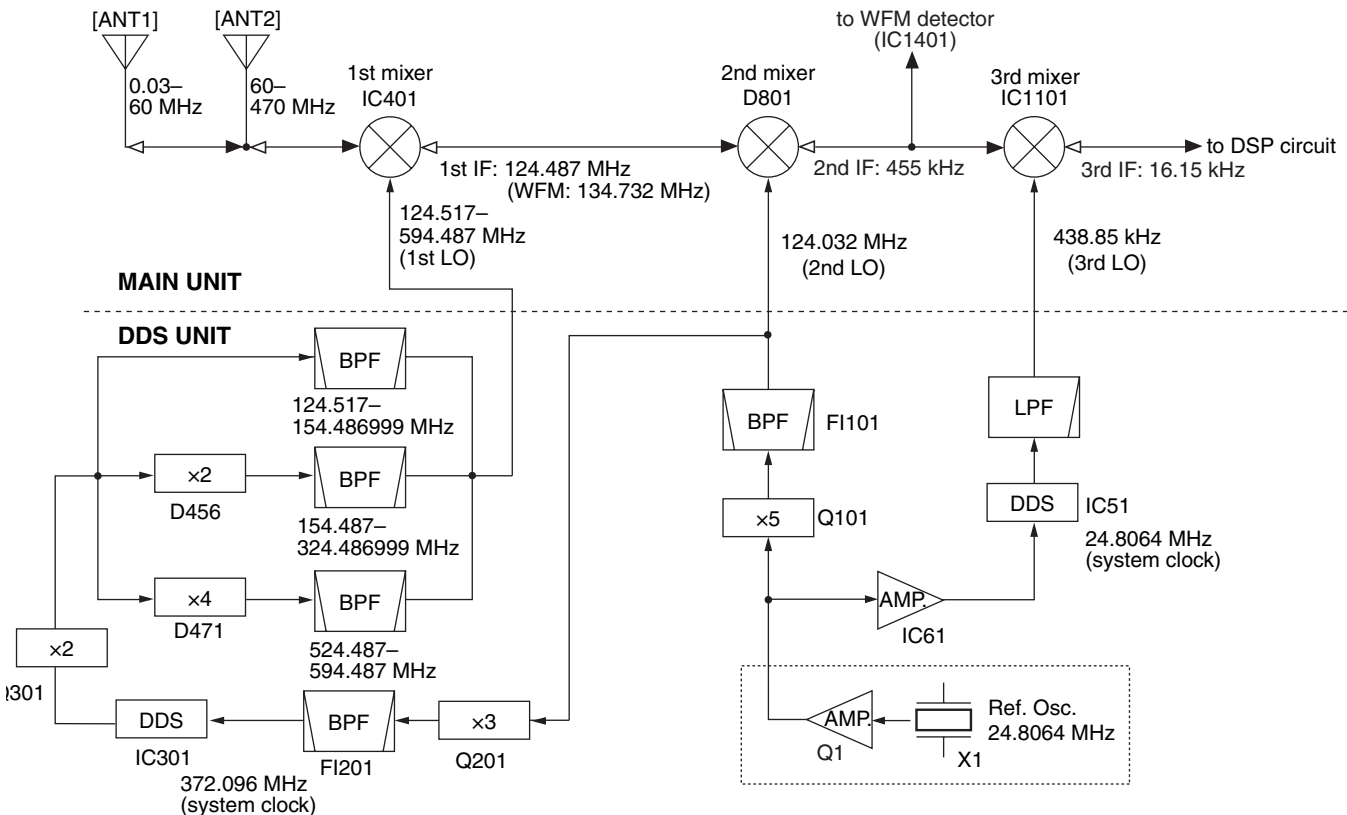

3-3-3 2ND LO AND REFERENCE OSCILLATOR CIRCUITS (DDS UNIT)

The reference oscillator (X1, Q1) generates a 24.8064 MHz frequency used for the 1st LO, 3rd LO and DSP circuits as a system clock and for the 2nd LO signal.

The oscillated signal is multiplied by 5 at Q101 and then passed through the bandpass filter (F1101). The filtered 124.032 MHz signal is amplified at Q151 and then applied to the 2nd mixer circuit (MAIN unit) after being passed through the low-pass filter (L153, C154–C156) and attenuator (R157–R159) via J151 as the 2nd LO signal.

3-3-4 3RD LO CIRCUIT (DDS UNIT)

The 3rd LO circuit generates a 3rd LO signal and shift the frequency for the operating mode needed.

The DDS IC (IC51) generates a 10-bit digital signal. The 24.8064 MHz system clock signal from the reference oscillator (X1, Q1) is buffer amplified at IC61 (pins 2, 4) and then applied to DDS IC (IC51, pins 5, 10). The DDS IC (IC51) generates the 438.85 kHz frequency signal and then output from pin 10. The output signal is applied to the low-pass filter (L53, C59–C61) and then applied to the 3rd mixer circuit (MAIN unit) via J952 (pin 13) as the 3rd LO signal.

• 3RD LO FREQUENCY

Mode	RX frequency [kHz]	TX frequency [kHz]
USB	440.350	440.350
LSB	437.350	437.350
CW	438.850 (–CW PITCH)	438.850
CW-R	438.850 (+CW PITCH)	438.850
RTTY	436.555*	436.555*
RTTY-R	440.975*	436.555*
AM	438.850	438.850
FM	438.850	438.850

*RTTY TONE: 2125 Hz, RTTY SHIFT: 170 Hz

3-4 LOGIC CIRCUITS

3-4-1 BAND SELECTION DATA

Frequency [MHz]	IC2151 (MAIN) IC2152 (MAIN)	IC2152 (MAIN) IC981 (PA)	IC901 (DDS)
	HPF (MAIN)	LPF (PA)	LOF (DDS)
0.03–1.599999	B0	L1	LOF1
1.6–1.999999	B1		
2.0–3.399999	B2	L2	
3.4–3.999999	B3	L3	
4.0–6.899999			
6.9–7.300000	B4	L4	
7.300001–7.999999			
8.0–10.999999			
11.0–13.899999			
13.9–14.350000	B5	L5	
14.350001–14.999999			
15.0–20.899999			
20.9–21.45	B6	L6	
21.450001–21.999999			
22.0–29.999999	T: B1 R: B7	L7	LOF2
30.0–49.999999	B7		
50.0–54.0	T: B1 R: B7	L8	LOF3
54.000001–59.999999	L8		LOF4
60.0–115.512999			LOF5
115.513–128.999999			LOF6
129.0–148.0			
148.000001–199.999999	L9		L9
400.0–470.0			

3-5 POWER SUPPLY CIRCUITS

3-5-1 FRONT UNIT VOLTAGE LINE

Line	Description
3.3 V	Common 3.3 V converted from the 5 V line by the 3.3 V regulator circuit (IC151). The output voltage is applied to the sub CPU (IC2003), etc.
5 V	Common 5 V converted from the 8 V line by the 5 V regulator circuit (IC101). The output voltage is applied to the LCD driver (IC506), etc.

3-5-2 MAIN UNIT VOLTAGE LINE

Line	Description
3.3 V	Common 3.3 V converted from the 5 V line by the 3.3 V regulator circuit (IC1801). The output voltage is applied to the D/A converter ICs (IC2151–IC5155), etc.
5 V	Common 5 V converted from the H V line by the 5 V regulator circuit (IC1951). The output voltage is applied to the CODEC IC (LOGIC unit; IC551), low-pass filters (LOGIC unit; IC451, IC502), etc.
8 V	Common 8 V line converted from the HV line by the 8 V regulator circuit (IC1901). The output voltage is applied to the buffer amplifiers (IC2101–IC2103), analog switches (IC2156, IC2251), etc.
T8	Transmit 8 V controlled by the T8 regulator circuit (Q1703, Q1704) using TXS signal from the CPU (LOGIC unit; IC1302, pin 106). The output voltage is applied to the RF switch (Q101), 2nd IF amplifier (Q701), 3rd IF amplifier (Q901), etc.
R8	Receive 8 V controlled by the R8 regulator circuit (Q1701, Q1702) using RXS signal from the CPU (LOGIC unit; IC1302, pin 105). The output voltage is applied to the 2nd IF amplifier (Q702), 3rd IF amplifier (Q1001), 3rd mixer (Q1101), etc.

Pin number	Port name	Description
38	LDT	Outputs data signal for the LCD driver (IC506).
39	LDST	Outputs strobe signal for the LCD driver (IC506).
47	FSQS	Outputs the squelch control signal. High: Squelch is opened.
48	RXD	Outputs the RX LED control signal. High: While receiving or squelch is opened.
54	BLV	Outputs the dimmer control signal for the LCD backlights.
55	KLV	Outputs the dimmer control signal for the key backlights.
56	TXD	Outputs TX LED control signal. Low : While transmitting.
57	PBT1D	Outputs control signal for [PBT/M-ch/RIT] indicator. Low : While the RIT function is ON.
58	PBT2D	Outputs control signal for [PBT/M-ch/RIT] indicator. Low : While the PBT function is ON.
70	LRXD	Input port for data signal from the main CPU (LOGIC unit; IC1302).
71	LTXD	Outputs data signal to the main CPU (LOGIC unit; IC1302).
73	AFGL	Input port for [AF] control.
74	SQLL	Input port for [RF/SQL] control.
75	PTTL	Input port for PTT control signal from the microphone that is connected to the FRONT unit.
77	FUDL	Input port for [UP] and [DN] switches from the optional microphone (HM-103, SM-20) that is connected to the FRONT [MIC] connector.
78	KI0L	Input port for [MODE], [P.AMP/ATT], [▲(MENU/GRP)] and [▼(MENU/GRP)] keys.
79	KI1L	Input port for [F-1], [F-2], [F-3] and [F-4] keys.
80	KI2L	Input port for [NB LEV], [NR LEV], [N/ANF] and [SET/REC] keys.

3-6 PORT ALLOCATIONS

3-6-1 SUB-CPU (DISPLAY UNIT; IC2003)

Pin number	Port name	Description
3, 5	MDBK, MDAK	Input ports for [DIAL].
13, 14	S1AK, S1BK	Input ports for [PBT2/M-ch] control.
15, 16	S2AK, S2BK	Input ports for [PBT1/RIT] control.
21	VRK	Input port for [AF] switch.
22	PBTK	Input port for [PBT/M-ch] switch.
23	TUNK	Input port for [TUNER/CALL] key.
24	TSK	Input port for [TS] key.
25	LCKK	Input port for [LOCK] key.
26	BUPK	Input port for [▲(BAND)] key.
27	BDNK	Input port for [▼(BAND)] key.
28	FMSL	Input port for the HM-151 connection detection.
35	PHNK	Input port for the headphones connection detection.
37	LCK	Outputs clock signal for the LCD driver (IC506).

3-6-2 MAIN CPU (LOGIC UNIT; IC1302)

Pin number	Port name	Description
26	CYDT	Outputs data signal for the clock generator (IC1201) for display control.
27	CYCK	Outputs clock signal for the clock generator (IC1201) for display control.
29	RTCDT	I/O port for the data signal from/to the clock IC (IC1304) for clock indication and timer function.
30	RTCCK	Outputs clock signal for the clock IC (IC1304) for clock indication and timer function.
42	LOST	Outputs strobe signal for the D/A converter (DDS unit; IC901).
43	MST	Outputs strobe signal for the D/A converter ICs (MAIN unit; IC2151-IC2154).
46	MMDK	Input port for the data signal from the microphone that is connected to the rear [MIC] connector.
47	DRES	Outputs the reset signal for the DSP ICs (IC301, IC2201).
48	PRES#	Outputs the reset signal for the LCD controller (IC1226) and DDS IC (DDS unit; IC301).
49	SQSS	Outputs the squelch control signal for the ACC connector and connected microphone.
51	MCK	Outputs clock signal for the D/A converter ICs (MAIN unit; IC2151-IC2154).
52	MDT	Outputs serial data signal for the D/A converter ICs (MAIN unit; IC2151-IC2154).
57	SDSS	Outputs the signal for H SEND or V SEND selection. High: While V SEND is selected.
58	TDAT	• Outputs data signal for AT-180. • Outputs start signal for AH-3/AH-4.
81	DTXD	Outputs data signal for the DSP IC (IC301).
82	DRXD	Input port for data signal from the DSP IC (IC301).
83	2T8V	Outputs the TX band signal. High: While transmitting the 144 MHz band.
104	4T8V	Outputs the TX band signal. High: While transmitting the 430 MHz band.
105	RXS	Outputs R8 regulator (Q1701, Q1702) control signal. Low : While receiving.
106	TXS	Outputs T8 regulator (Q1703, Q1704) control signal. Low :While transmitting.
107	POWS	Outputs the power control signal . High:When IC-7000 is power ON.

Pin number	Port name	Description
109	ECK	Outputs clock signal to the EEPROM (IC1301).
110	EDT	I/O port for the EEPROM (IC1301).
113	FORL	Input port for the forward voltage.
114	REFL	Input port for the reflection voltage .
115	ALCL	Input port for ALC level.
116	SNDL	Input port for PTT control signal from the FRONT unit or ACC connector.
117	DPTL	Input port for PTT control signal from the DATA connector.
118	THML	Input port for the temperature detection signal.
119	MUDL	Input port for [UP] and [DN] switches from the optional microphone (HM-103, SM-20) that is connected to the rear [MIC] connector.
121, 122	DASK, DOTK	Input ports for [KEY] jack.
124	MMSL	Input port for the HM-151 connection detection.
127	TKEY	Input port for tuner ON.
128	TRD	Input port for the detected signal for the tuner unit connection.
133	LTXD	Outputs data signal to the sub CPU (DISPLAY unit; IC2003).
134	LRXD	Inputs data signal from the sub CPU (DISPLAY unit; IC2003).
135	PWRK	Input port for [PWR] key. Low : While [PWR] key is pushed.
137	3DST	Outputs strobe signal to the DDS IC (DDS unit; IC51) for the 3rd LO signal.
138	PCK	Outputs clock signal for the DDS ICs (DDS unit; IC51, IC301) and D/A converter (DDS unit; IC901).
140	1DST	Output strobe signal to the DDS IC (DDS unit; IC301) for the 1st LO signal.
142	PDT	Outputs serial data signal for the DDS ICs (DDS unit; IC51, IC301) and D/A converter (DDS unit; IC901).

SECTION 4 ADJUSTMENT PROCEDURES

4-1 PREPARATION

Some adjustment must be performed on the adjustment mode.

REQUIRED TEST EQUIPMENT

EQUIPMENT	GRADE AND RANGE	EQUIPMENT	GRADE AND RENG
DC power supply	Output voltage : 13.8 V DC Current capacity : 30 A or more	Distortion meter	Frequency range : 1 kHz \pm 10 % Measuring range : 1–100 %
RF power meter (terminated type)	Measuring range : 0.5–200 W Frequency range : 1.8–500 MHz Impedance : 50 Ω SWR : 1.2 : 1 or better	Oscilloscope	Frequency range : DC–100 MHz Measuring range : 0.01–10 V
Frequency counter	Frequency range : 0.1–500 MHz Frequency accuracy : \pm 1 ppm or better Sensitivity : 100 mV or better	Digital multimeter	Input impedance : 10 M Ω /DC or more
		AC millivoltmeter	Measuring range : 10 mV to 10 V
		DC voltmeter	Input impedance : 50 k Ω /V DC or more
RF voltmeter	Frequency range : 0.1–500 MHz Measuring range : 0.01–10 V	DC ammeter	Measuring capability : 5 A/30 A
		Audio generator	Frequency range : 300–3000 Hz Measuring range : 1–500 mV
Standard signal generator (SSG)	Frequency range : 0.1–500 MHz Output level : 0.1 μ V to 32 mV (–127 to –17 dBm)	External speaker	Input impedance : 8 Ω Capacity : 5 W or more

ENTERING THE ADJUSTMENT MODE

- Turn the transceiver's power OFF.
- Connect the JIG plug (see illustration below) to [REMOTE] jack on the rear panel.
- While pushing and holding [P.AMP/ATT] and [TUNE/CALL], turn the transceiver power ON.

NOTE: Exiting from the adjustment mode when the transceiver's power is OFF.

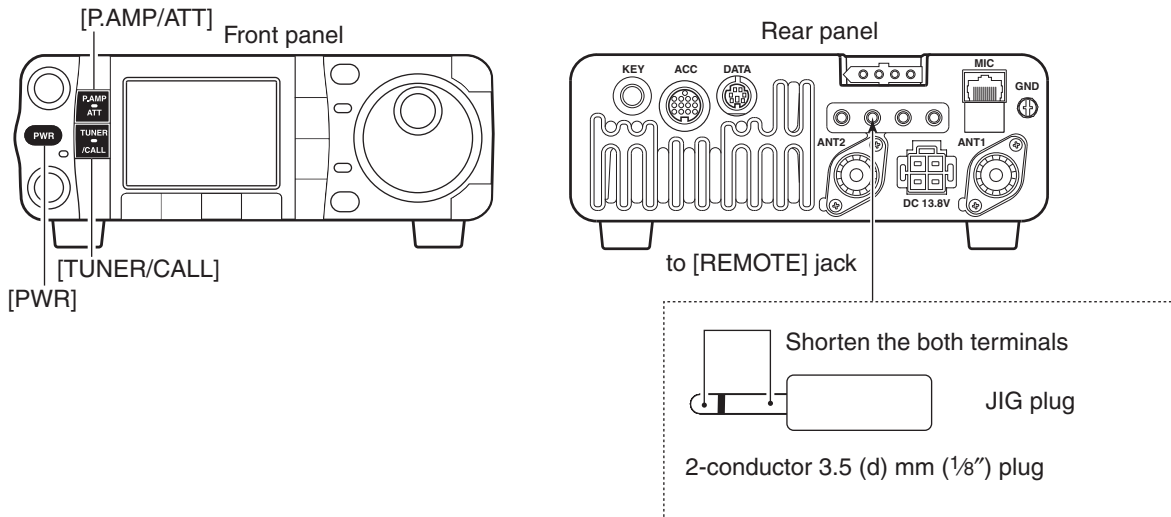

OPERATING ON THE ADJUSTMENT MODE

- Enter DDS adjustment mode. : Push [F-1 (REF)]
- Enter TX adjustment mode. : Push [F-2 (TX)]
- Enter RX adjustment mode. : Push [F-3 (RX)]
- Store the set value. : Push [F-4 (SET)]
- Adjust the value. : Rotate [DIAL]

CAUTION: Connect a dummy load to the antenna connectors during the transmitter adjustment, when the adjustment condition does not require a test equipment.

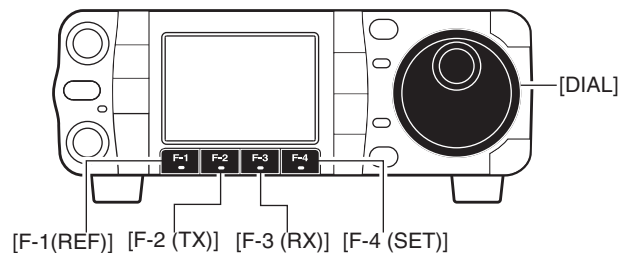

• CONNECTION

• Microphone connector (Rear panel view)

NOTE! Connect the test equipment to the microphone connector on the rear panel, otherwise the transmitter adjustment will not be adjusted properly.

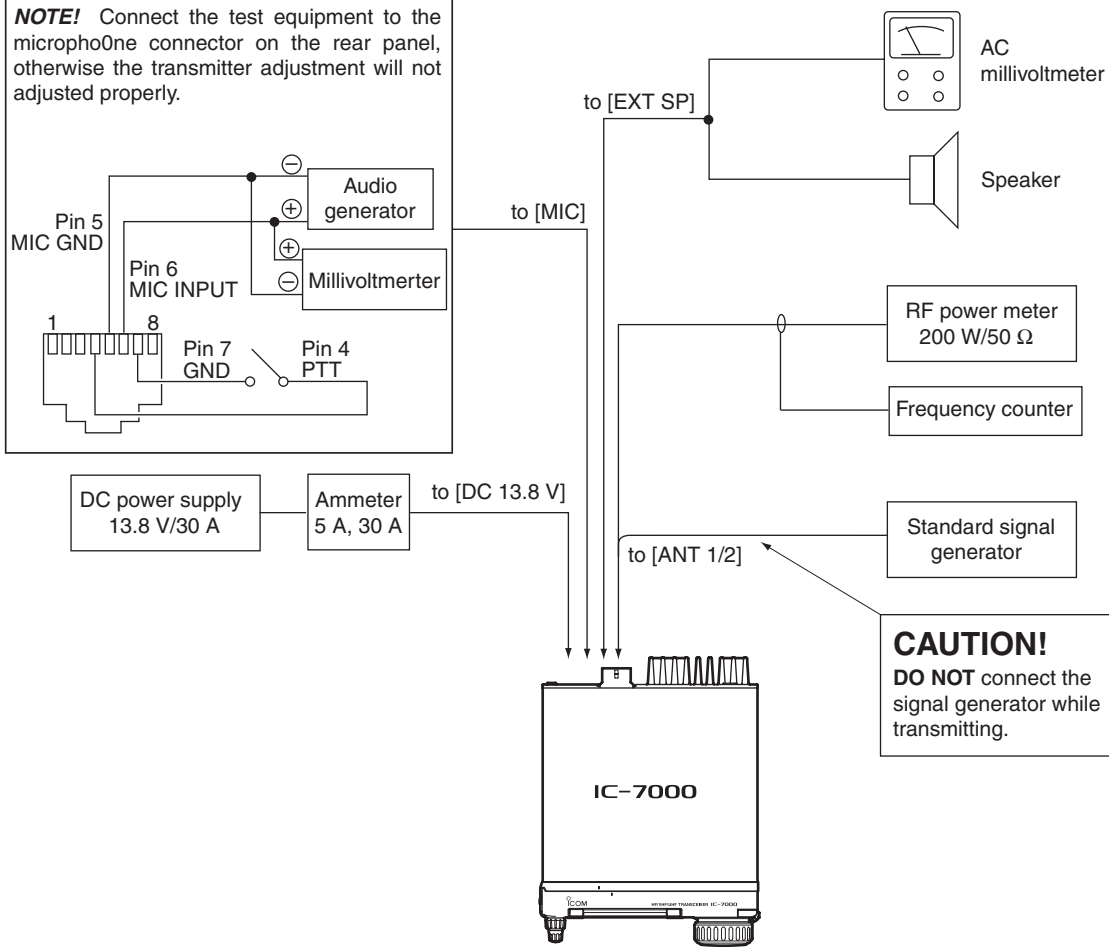

4-2 DDS ADJUSTMENT

ADJUSTMENT	ADJUSTMENT CONDITION	DISPLAY	OPERATION
REFERENCE FREQUENCY	1	<ul style="list-style-type: none"> Enter the adjustment mode. Push [F1 (REF)]. 	
	2	<ul style="list-style-type: none"> Disconnect P4 from J801 (MAIN unit). Receiving 	REF OSC Connect a frequency counter to P4 and set 124.032000 MHz using [DIAL]. Then push [F-4 (SET)].
	After the adjustment, exit the adjustment mode and connect P4 to J801 (MAIN unit).		

4-3 DISPLAY ADJUSTMENT

ADJUSTMENT	ADJUSTMENT CONDITION	MEASUREMENT		VALUE	ADJUSTMENT	
		UNIT	LOCATION		UNIT	ADJUST
DISPLAY	1	DIS-PLAY	Connect a frequency counter to CP536 through a capacitor (0.0047 μF) and resistor (1 kΩ) in series.	3.579545 MHz [USA]	DIS-PLAY	C536
	4.433619 MHz [Others]					
	2	<ul style="list-style-type: none"> Receiving 	Connect a frequency counter to CP505.	15.734 kHz [USA] 15.625 kHz [Others]	DIS-PLAY	R541
After the adjustment, connect J2231 (MAIN unit) and disconnect jumper wire between DISPLAY unit ground and MAIN unit ground.						

4-4 TRANSMITTER ADJUSTMENT

ADJUSTMENT	ADJUSTMENT CONDITION	DISPLAY	OPERATION
DRIVE/FINAL IDLING CURRENT	1	<ul style="list-style-type: none"> Enter the adjustment mode. Push [F-2 (TX)]. 	
	2	<ul style="list-style-type: none"> Connect an RF power meter to [ANT1] and [ANT2] connectors. Apply no audio signals to [MIC] jack. Connect a DC ammeter (5 A type) between power supply and transceiver. Transmitting 	Driver Idle Cur Preset the adjustment value to "00" using with [DIAL], and check the driving current.
	3		Rotate [DIAL] to set adjustment value to 1 A value from the driving current of "00" value. Then push [F-4 (SET)].
	4		Final Idle Cur(HF/50M)-1 Preset the adjustment value to "00" using with [DIAL], and check the driving current.
	5		Rotate [DIAL] to set adjustment value to 1 A value from the driving current of "00" value. Then push [F-4 (SET)].
	6		Final Idle Cur(HF/50M)-2 Preset the adjustment value to "00" using with [DIAL], and check the driving current.
	7		Rotate [DIAL] to set adjustment value to 1 A value from the driving current of "00" value. Then push [F-4 (SET)].
	8		Final Idle Cur(144M) Preset the adjustment value to "00" using with [DIAL], and check the driving current.
	9		Rotate [DIAL] to set adjustment value to 2 A value from the driving current of "00" value. Then push [F-4 (SET)].
	10		Final Idle Cur(430M) Preset the adjustment value to "00" using with [DIAL], and check the driving current.
	11		Rotate [DIAL] to set adjustment value to 2.5 A value from the driving current of "00" value. Then push [F-4 (SET)].
After the adjustment, exit the adjustment mode.			

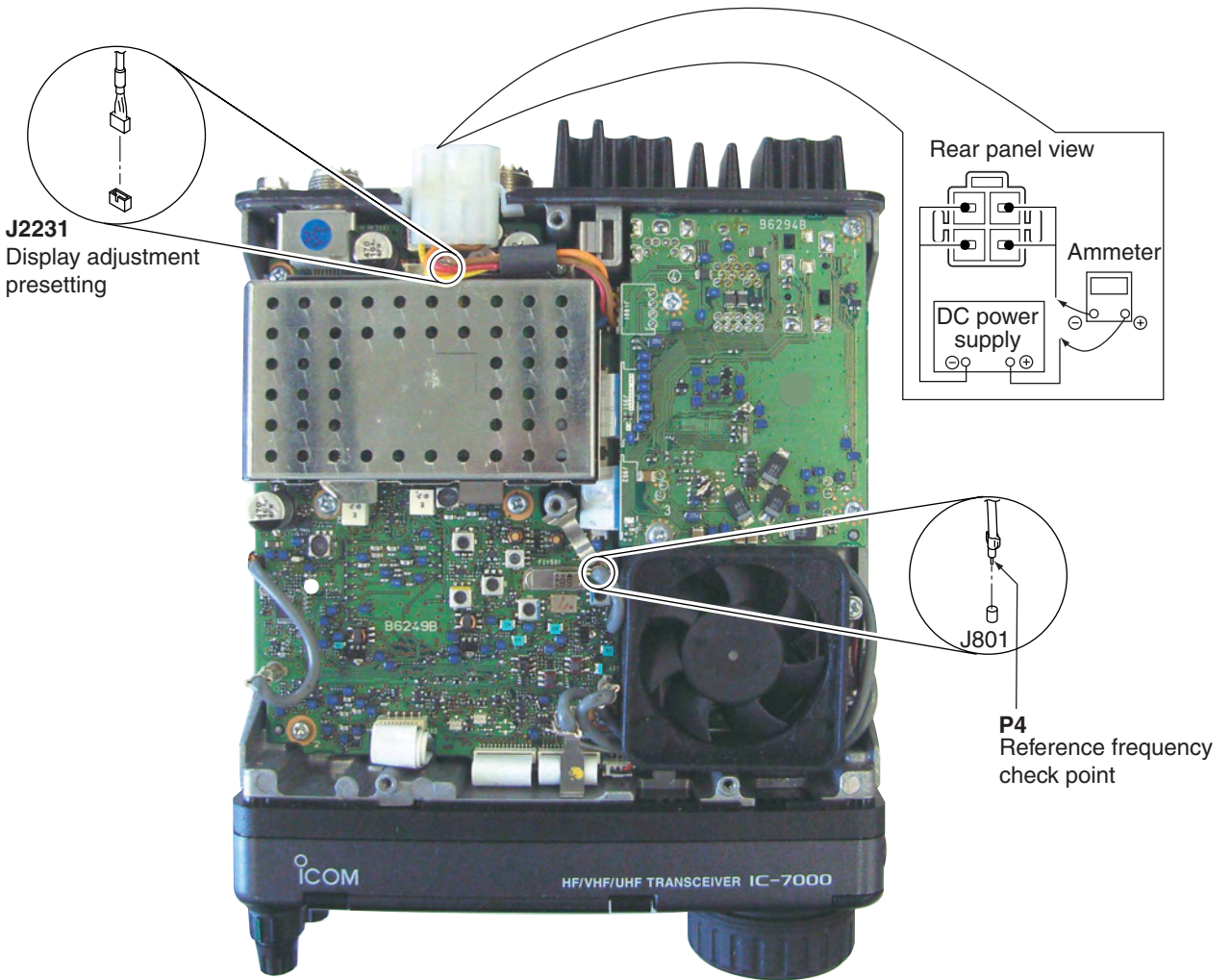

• MAIN UNIT

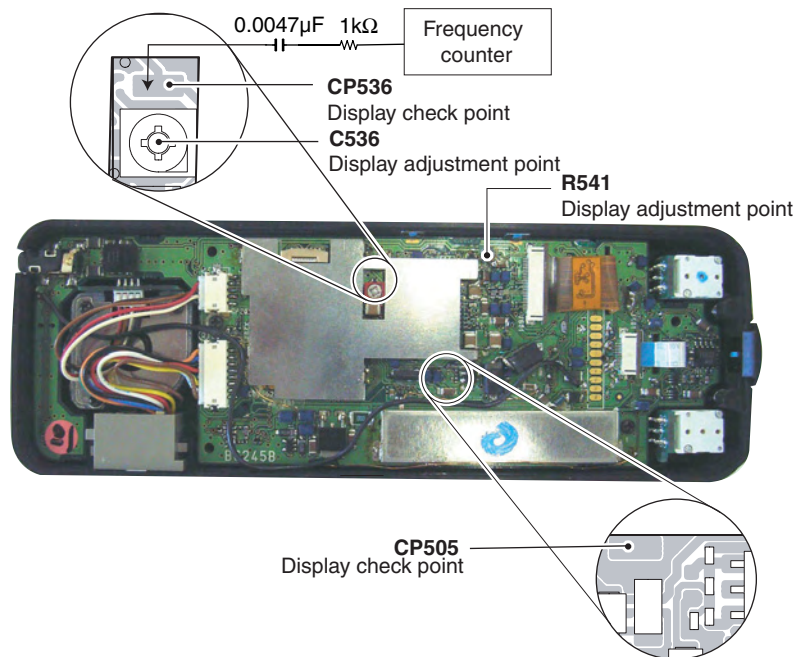

• FRONT UNIT



4-4 TRANSMITTER ADJUSTMENT (continue)

ADJUSTMENT	ADJUSTMENT CONDITION	MEASUREMENT		VALUE	ADJUSTMENT		
		UNIT	LOCATION		UNIT	ADJUST	
SWR DETECTOR	1	<ul style="list-style-type: none"> Operating freq : 10.10000 MHz MODE : USB RF Power : 100% MIC Gain : 50% Connect an audio generator to [MIC] connector and set as; Frequency : 1.5 kHz Connect a wire between CP1601 (MAIN unit) and ground. Transmitting 	REAR panel	Connect an RF power meter to [ANT1] connector.	80 W	Audio generator	Output level
	2		PA	Connect a DC voltmeter to CP961.	Minimum voltage	PA	C964
After adjustment, disconnect the wire between CP1601 (MAIN unit) and ground.							
TX PEAK	1	<ul style="list-style-type: none"> Operating freq : 10.10000 MHz MODE : USB RF Power : 100% MIC Gain : 50% Preset R1618 (MAIN unit) as the illustration at right.  Preset L604, L612 and L904 (MAIN unit) as the illustration at right.  Connect an audio generator to [MIC] connector and set as ; Level : 1.5 kHz/3 mV (Adjust the audio generator output level to keep less than 50 W output power.) Transmitting 	REAR panel	Connect an RF power meter to [ANT1] connector.	Maximum output power	MAIN	L701
ADJUSTMENT	ADJUSTMENT CONDITION	DISPLAY		OPERATION			
TX TOTAL GAIN	1	<ul style="list-style-type: none"> Enter the adjustment mode. Push [F-2 (TX)]. 					
	2	Connect an RF power meter to [ANT1] connector.	TX Total Gain(HF1)	Set the output power to 50 W using [DIAL]. Then push [F-4 (SET)].			
	3	Connect an audio generator to [MIC] connector and set as; Level : 1.5 kHz/3 mV	TX Total Gain(HF2)	Set the output power to 50 W using [DIAL]. Then push [F-4 (SET)].			
	4	Transmitting	TX Total Gain(HF3)	Set the output power to 50 W using [DIAL]. Then push [F-4 (SET)].			
	5		TX Total Gain(50M)	Set the output power to 50 W using [DIAL]. Then push [F-4 (SET)].			
	6	Connect an RF power to [ANT2] connector.	TX Total Gain(144M)	Set the output power to 25 W using [DIAL]. Then push [F-4 (SET)].			
	7	Transmitting	TX Total Gain(430M)	Set the output power to 17.5 W using [DIAL]. Then push [F-4 (SET)].			

• MAIN UNIT

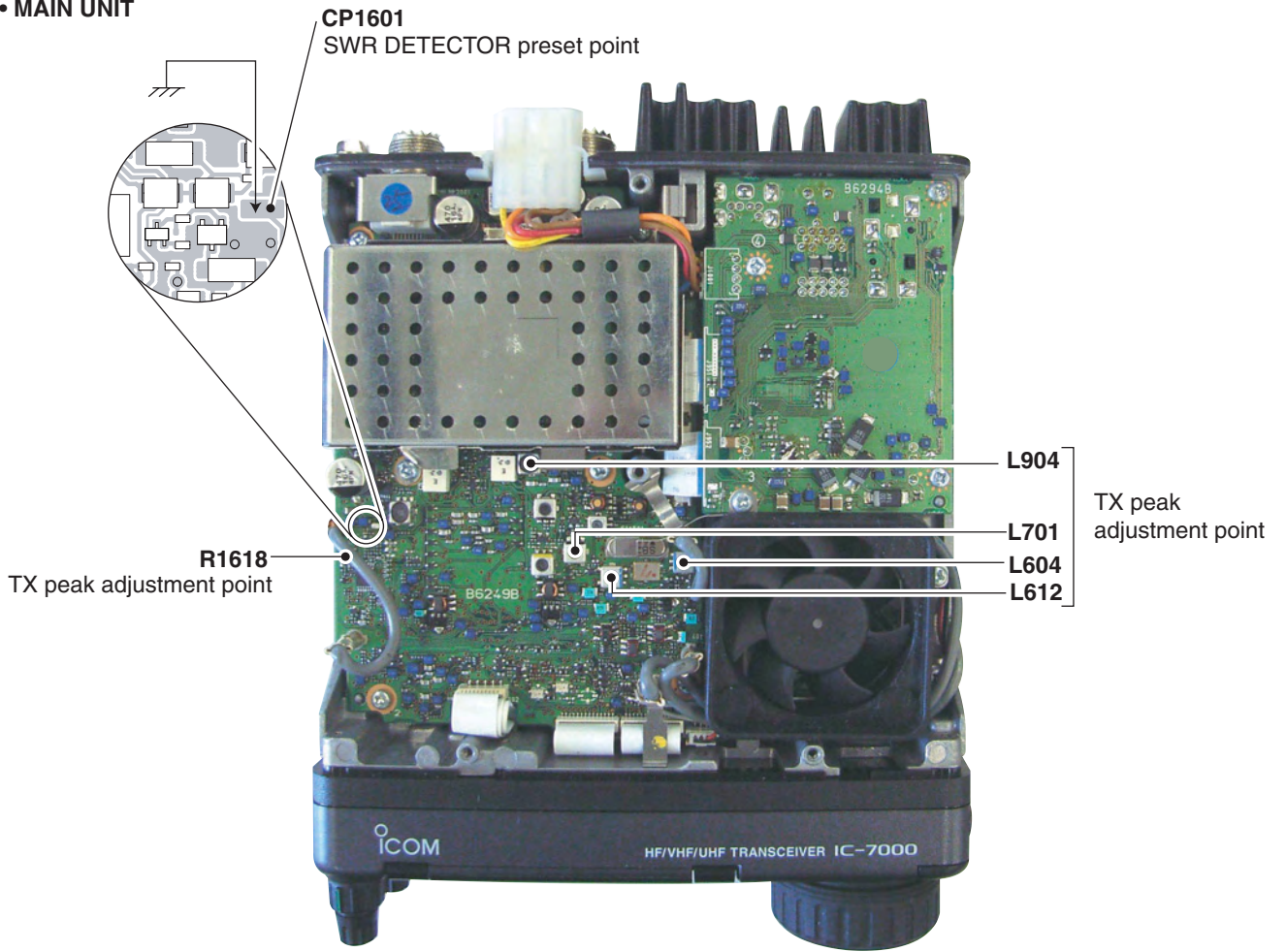

• PA UNIT

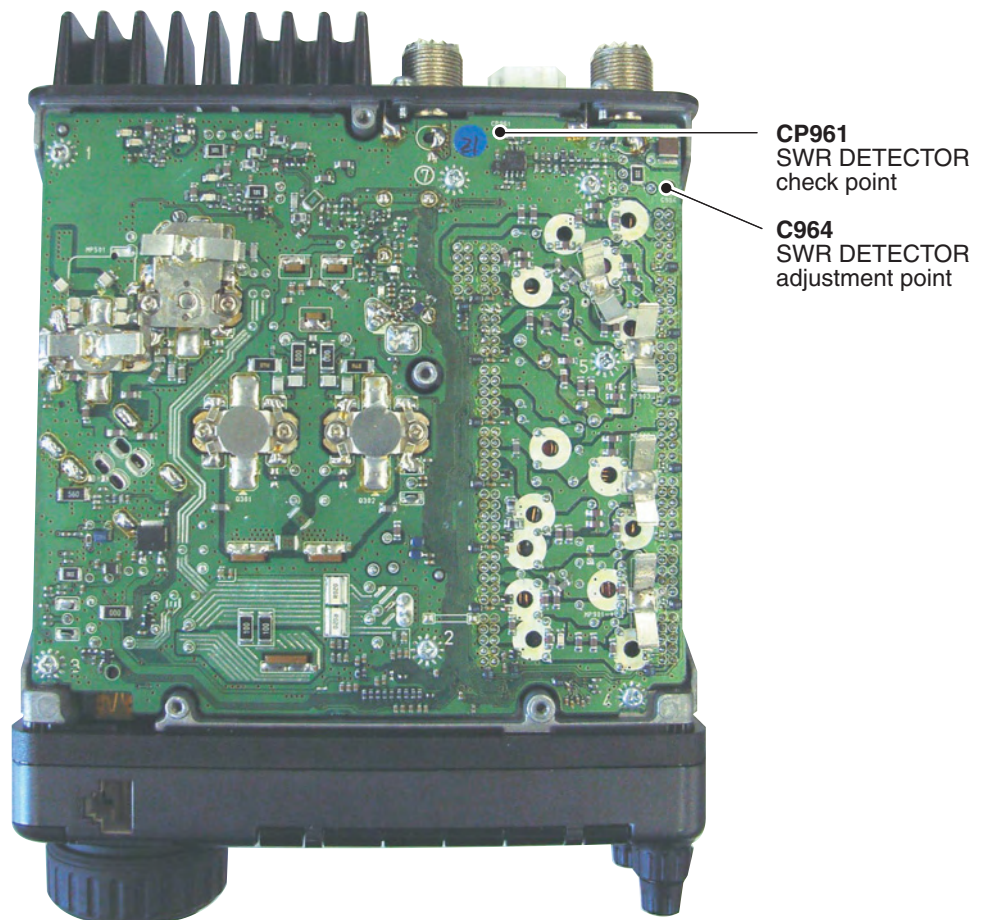

4-4 TRANSMITTER ADJUSTMENT (Continue)

ADJUSTMENT		ADJUSTMENT CONDITION	DISPLAY	OPERATION
TX OUTPUT POWER (HF)	1	<ul style="list-style-type: none"> • Connect an RF power meter to [ANT1] connector. • Connect an audio generator to [MIC] connector and set as; Level : 1.5 kHz/30 mV • Transmitting 	Po Min(HF)	Set the output power to 1 W using [DIAL]. Then push [F-4 (SET)] .
	2		Po Tune(HF)	Set the output power to 10 W using [DIAL]. Then push [F-4 (SET)].
	3		Po 25%(HF)	Set the output power to 25 W using [DIAL]. Then push [F-4 (SET)].
	4		Po 50%(HF)	Set the output power to 50 W using [DIAL]. Then push [F-4 (SET)].
	5		Po(HF APC Low Volt)	Set the output power to 75 W using [DIAL]. Then push [F-4 (SET)].
	6		Po 100%(HF)	Set the output power to 95 W using [DIAL]. Then push [F-4 (SET)].
	7		Po Max(HF)	Set the output power to 105 W using [DIAL]. Then push [F-4 (SET)] key.
APC (HF)	1		APC(HF)	Push [F-4 (SET)].
TX OUTPUT POWER (AM)	1	<ul style="list-style-type: none"> • Connect an RF power meter to [ANT1] connector. • Apply no audio signal to [MIC] connector. • Transmitting 	AM POCV Ratio	Set the output power to 35 W using [DIAL]. Then push [F-4 (SET)].
TX OUTPUT POWER (50 MHz)	1	<ul style="list-style-type: none"> • Connect an RF power meter to [ANT1] connector. • Connect an audio generator to [MIC] connector and set as; Level : 1.5 kHz/30 mV • Transmitting 	Po Min(50 M)	Set the output power to 1 W using [DIAL]. Then push [F-4 (SET)].
	2		Po Tune(50 M)	Set the output power to 10 W using [DIAL]. Then push [F-4 (SET)].
	3		Po 25%(50 M)	Set the output power to 25 W using [DIAL]. Then push [F-4 (SET)].
	4		Po 50%(50 M)	Set the output power to 50 W using [DIAL]. Then push [F-4 (SET)].
	5		Po 100%(50 M)	Set the output power to 90 W using [DIAL]. Then push [F-4 (SET)].
	6		Po Max(50 M)	Set the output power to 100 W using [DIAL]. Then push [F-4 (SET)].

4-4 TRANSMITTER ADJUSTMENT (continue)

ADJUSTMENT		ADJUSTMENT CONDITION	DISPLAY	OPERATION
TX OUTPUT POWER (144 MHz)	1	<ul style="list-style-type: none"> • Connect an RF power to [ANT2] connector. • Connect an audio generator to [MIC] connector and set as; Level : 1.5 kHz/30 mV • Transmitting 	Po Min(144 M)	Set the output power to 1 W using [DIAL]. Then push [F-4 (SET)].
	2		Po 25%(144 M)	Set the output power to 12.5 W using [DIAL]. Then push [F-4 (SET)].
	3		Po 50%(144 M)	Set the output power to 25 W using [DIAL]. Then push [F-4 (SET)].
	4		Po 100%(144 M)	Set the output power to 45 W using [DIAL]. Then push [F-4 (SET)].
	5		Po Max(144 M)	Set the output power to 50 W using [DIAL]. Then push [F-4 (SET)].
APC (VHF)	1		APC(VHF)	Push [F-4 (SET)].
TX OUTPUT POWER (430 MHz)	1	<ul style="list-style-type: none"> • Connect an RF power meter to [ANT2] connector. • Connect an audio generator to [MIC] connector and set as; Level : 1.5 kHz/30 mV • Transmitting 	Po Min(430 M)	Set the output power to 1 W using [DIAL]. Then push [F-4 (SET)].
	2		Po 25%(430 M)	Set the output power to 8.75 W using [DIAL]. Then push [F-4 (SET)].
	3		Po 50%(430 M)	Set the output power to 17.5 W using [DIAL]. Then push [F-4 (SET)].
	4		Po 100%(430 M)	Set the output power to 31.5 W using [DIAL]. Then push [F-4 (SET)].
	5		Po Max(430 M)	Set the output power to 35 W using [DIAL]. Then push [F-4 (SET)].

4-4 TRANSMITTER ADJUSTMENT (continue)

ADJUSTMENT		ADJUSTMENT CONDITION	DISPLAY		OPERATION		
ALC	1	<ul style="list-style-type: none"> • Connect an RF power meter to [ANT1] connector. • Connect an audio generator to [MIC] connector and set as; Level : 1.5 kHz/30 mV • Transmitting 	ALC		Push [F-4 (SET)].		
Drive Min (HF/50 MHz)	1	<ul style="list-style-type: none"> • Set an audio generator as; Level : 1.5 kHz/20 mV • Transmitting 	Drive Min(HF/50 M)		Push [F-4 (SET)].		
ALC (144 MHz)	1	<ul style="list-style-type: none"> • Connect an RF power meter to [ANT2] connector. • Connect an audio generator to [MIC] connector and set as; Level : 1.5 kHz/30 mV • Transmitting 	ALC(144 M)		Push [F-4 (SET)].		
Drive Min (144 MHz)	1	<ul style="list-style-type: none"> • Set an audio generator as; Level : 1.5 kHz/20 mV • Transmitting 	Drive Min(144 M)		Push [F-4 (SET)].		
ALC (430 MHz)	1	<ul style="list-style-type: none"> • Connect an RF power meter to [ANT2] connector. • Connect an audio generator to [MIC] connector and set as; Level : 1.5 kHz/30 mV • Transmitting 	ALC(430 M)		Push [F-4 (SET)].		
Drive Min (430 MHz)	1	<ul style="list-style-type: none"> • Set an audio generator as; Level : 1.5 kHz/20 mV • Transmitting 	Drive Min(430 M)		Push [F-4 (SET)].		
SWR	1	<ul style="list-style-type: none"> • Connect a 50 Ω dummy load to [ANT1] connector. • Transmitting 	SWR=1		Push [F-4 (SET)].		
	2	<ul style="list-style-type: none"> • Connect a 100 Ω dummy load to [ANT1] connector. • Transmitting 	SWR=2		Push [F-4 (SET)].		
After the adjustment, exit the adjustment mode.							
ADJUSTMENT	ADJUSTMENT CONDITION	MEASUREMENT		VALUE	ADJUSTMENT		
		UNIT	LOCATION		UNIT	ADJUST	
ID APC	1 <ul style="list-style-type: none"> • Operating freq. : 18.10000 MHz • MODE : USB • Preset R1618 (MAIN unit) as illustration at right.  • Connect a wire between CP1601 (MAIN unit) and ground. • Connect an RF power meter or dummy load to [ANT1] connector. • Connect an audio generator to [MIC] connector and set as; Level : 1.5 kHz/30 mV • Transmitting 	REAR panel	Connect a DC ammeter (30 A type) between the DC power supply and transceiver.	22 A	MAIN	R1618	
							After the adjustment, disconnect the wire between CP1601 and ground.
RESIDUAL AM	1	<ul style="list-style-type: none"> • Operating freq. : 10.10000 MHz • MODE : FM • Connect an audio generator to [MIC] connector and set as; Level : 1 kHz/30 mV • Transmitting 	REAR panel	Connect an RF power meter to [ANT1] connector.	Maximum output power	MAIN	L701

• MAIN UNIT

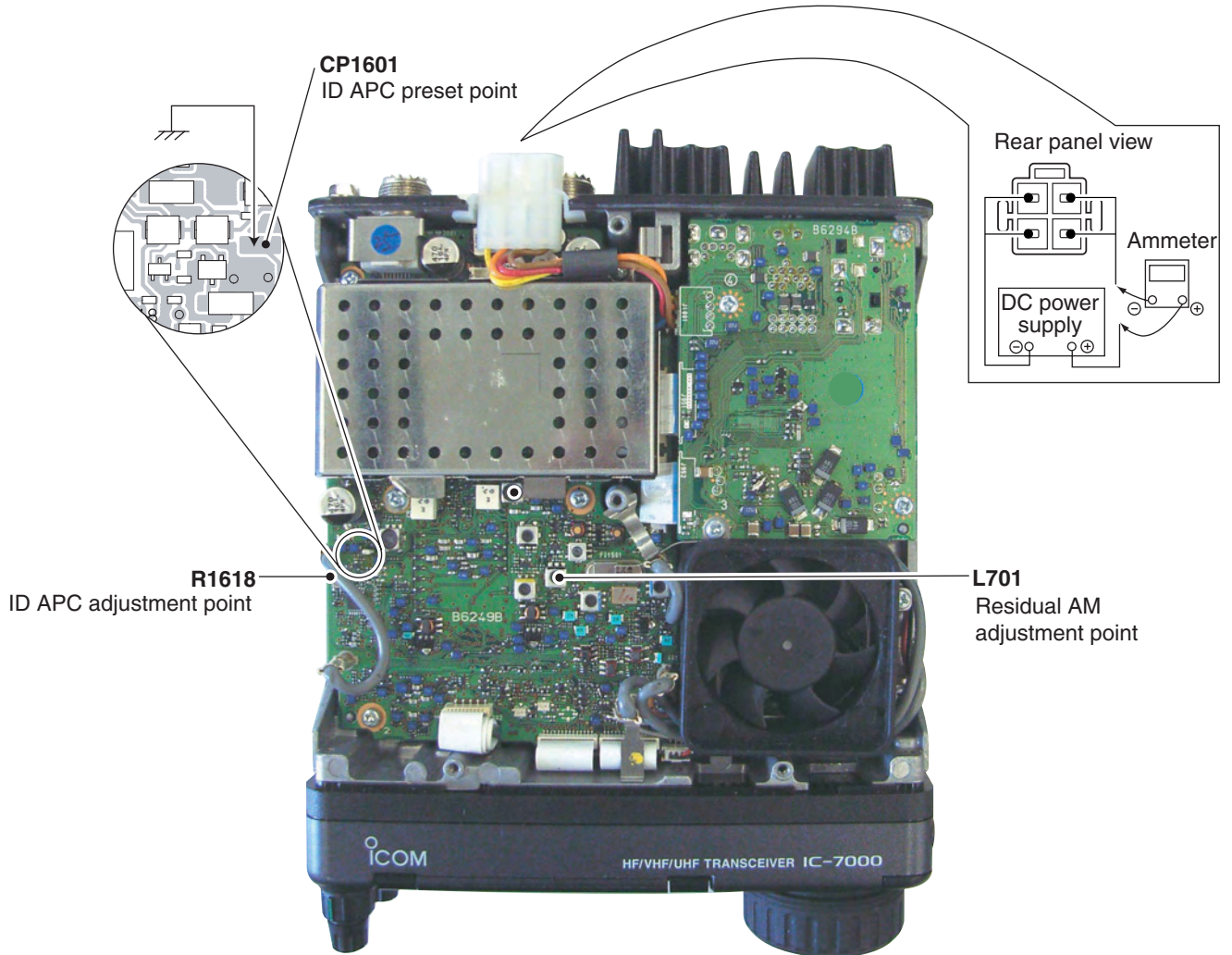

4-5 RECEIVER ADJUSTMENT

ADJUSTMENT	ADJUSTMENT CONDITION	MEASUREMENT		VALUE	ADJUSTMENT	
		UNIT	LOCATION		UNIT	ADJUST
RX PEAK (HF/50 MHz)	1 <ul style="list-style-type: none"> • Operating freq : 14.15000 MHz • MODE : USB • RIT : OFF • AGC : FAST • NB : OFF • Preamp : ON • Connect an SSG to [ANT1] connector and set as; <ul style="list-style-type: none"> Frequency : 14.15150 MHz Level : 500 μV* (-53 dBm) Modulation : OFF • Receiving 	REAR panel	Connect an AC millivoltmeter to [EXT SP] jack with an 8 Ω load.	Maximum AF output level	MAIN	L702, L703
ADJUSTMENT	ADJUSTMENT CONDITION	DISPLAY		OPERATION		
TOTAL GAIN (HF/50 MHz)	1 <ul style="list-style-type: none"> • Enter the adjustment mode. • Push [F-3 (RX)]. 					
	2 <ul style="list-style-type: none"> • Connect an SSG to [ANT1] connector and set as; <ul style="list-style-type: none"> Level : 500 μV* (-53 dBm) or OFF Modulation : OFF • Connect an AC millivoltmeter to [EXT SP] jack with an 8 Ω load. • Receiving 	Total Gain(HF/50 M)		Set 30 dB of AF level difference between 500 μ V and no signal input from the SSG using with [DIAL]. Then push [F-4 (SET)].		
S-METER (HF/50 MHz)	1 <ul style="list-style-type: none"> • Connect an SSG to [ANT1] connector and set as; <ul style="list-style-type: none"> Frequency : 14.15150 MHz Level : OFF • Receiving 	S0 Level		Push [F-4 (SET)].		
	2 <ul style="list-style-type: none"> • Set an SSG as; <ul style="list-style-type: none"> Level : 50 μV* (-73 dBm) • Receiving 	S9 Level		Push [F-4 (SET)].		
	3 <ul style="list-style-type: none"> • Set an SSG as; <ul style="list-style-type: none"> Level : 32 mV* (-17 dBm) • Receiving 	S9+60 Level		Push [F-4 (SET)].		
RECEIVE SENSITIVITY (VHF/UHF)	1 <ul style="list-style-type: none"> • Connect an SSG to [ANT2] connector and set as; <ul style="list-style-type: none"> Frequency : 60.2015 MHz Level : 10 μV* (-87 dBm) Modulation : OFF • Receiving 	Tuned BPF(60 M)		Push [F-4 (SET)].		
	2 <ul style="list-style-type: none"> • Set an SSG as ; <ul style="list-style-type: none"> Frequency : 90.8015 MHz • Receiving 	Tuned BPF(90 M)		Push [F-4 (SET)].		
	3 <ul style="list-style-type: none"> • Set an SSG as ; <ul style="list-style-type: none"> Frequency : 128.8015 MHz • Receiving 	Tuned BPF(128 M)		Push [F-4 (SET)].		
	4 <ul style="list-style-type: none"> • Set an SSG as ; <ul style="list-style-type: none"> Frequency : 129.2015 MHz • Receiving 	Tuned BPF(129 M)		Push [F-4 (SET)].		
	5 <ul style="list-style-type: none"> • Set an SSG as ; <ul style="list-style-type: none"> Frequency : 145.3015 MHz • Receiving 	Tuned BPF(145 M)		Push [F-4 (SET)].		

*The output level of a standard signal generator (SSG) is indicated as SSG's open circuit.

• MAIN UNIT

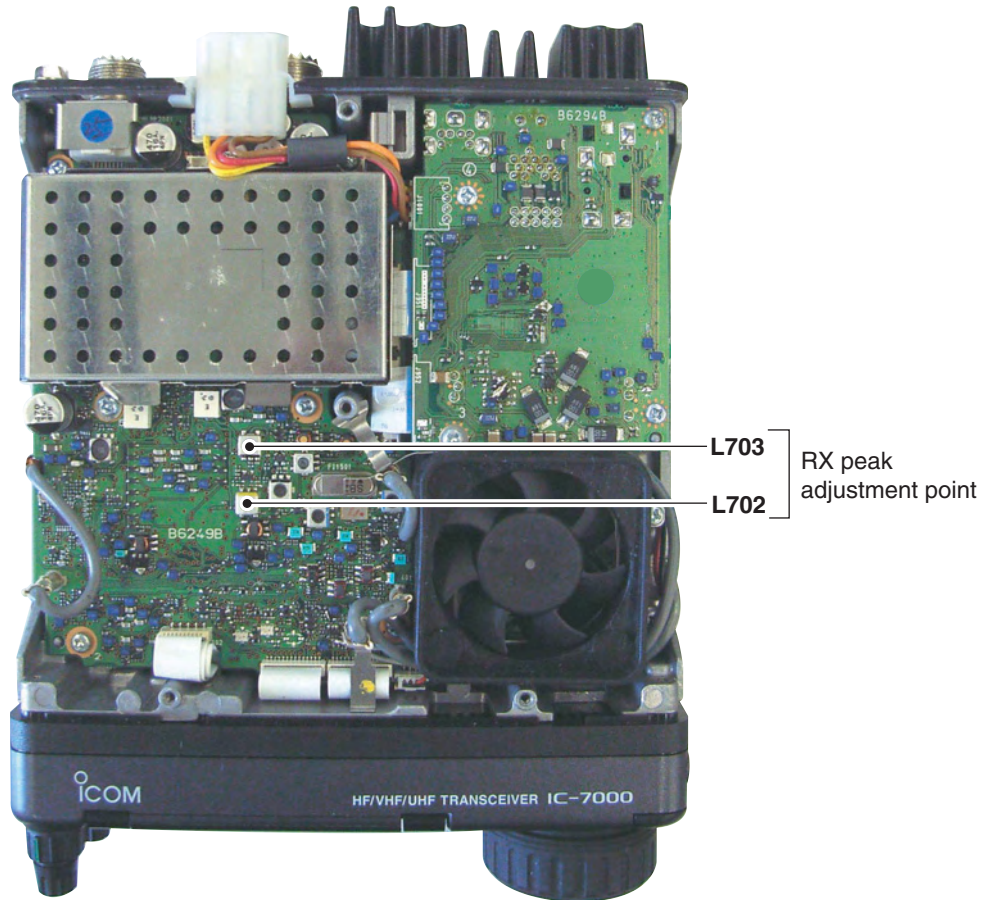

4-5 RECEIVER ADJUSTMENT (continue)

ADJUSTMENT		ADJUSTMENT CONDITION	DISPLAY	OPERATION			
RECEIVE SENSITIVITY (VHF/UHF)	6	<ul style="list-style-type: none"> Set an SSG as ; Frequency : 169.8015 MHz Receiving 	Tuned BPF(170 M)	Push [F-4 (SET)].			
	7	<ul style="list-style-type: none"> Set an SSG as ; Frequency : 400.2015 MHz Receiving 	Tuned BPF(400 M)	Push [F-4 (SET)].			
	8	<ul style="list-style-type: none"> Set an SSG as ; Frequency : 435.2015 MHz Receiving 	Tuned BPF(435 M)	Push [F-4 (SET)].			
	9	<ul style="list-style-type: none"> Set an SSG as ; Frequency : 469.8015 MHz Receiving 	Tuned BPF(470 M)	Push [F-4 (SET)].			
RX TOTAL GAIN (VHF/UHF)	1	<ul style="list-style-type: none"> Connect an SSG to [ANT2] connector and set as; Frequency : 435.2015 MHz Level : 500 μV* (-53 dBm) or OFF Modulation : OFF Connect an AC millivolt meter to [EXT SP] jack with an 8 Ω load. Receiving 	Total Gain(144M/430M)	Set 25 dB of AF level difference between 500 μ V and no signal input from the SSG using with [DIAL]. Then push [F-4 (SET)].			
S-METER (WFM)	1	<ul style="list-style-type: none"> Connect an SSG to the [ANT2] connector and set as; Frequency : 90.80 MHz Level : 0.56 μV* (-112 dBm) Modulation : OFF Receiving 	S0 Level(WFM)	Push [F-4 (SET)].			
	2	<ul style="list-style-type: none"> Set an SSG as; Level : 3.2 μV* (-97 dBm) Receiving 	S9 Level(WFM)	Push [F-4 (SET)].			
	3	<ul style="list-style-type: none"> Set an SSG as; Level : 32 μV* (-77 dBm) Receiving 	S9+60 Level(WFM)	Push [F-4 (SET)].			
After the adjustment, exit the adjustment mode.							
ADJUSTMENT	ADJUSTMENT CONDITION	MEASUREMENT		VALUE	ADJUSTMENT		
		UNIT	LOCATION		UNIT	ADJUST	
WFM DISTORTION	1	<ul style="list-style-type: none"> Operating freq : 90.00000 MHz MODE : WFM Preamp : ON Connect an SSG to [ANT2] connector and set as; Frequency : 90.0000 MHz Level : 3.2 μV* (-97 dBm) Modulation : 1 kHz Deviation : 50 kHz Receiving 	REAR panel	Connect a distortion meter to [EXT SP] jack with an 8 Ω load.	Minimum AF distortion level	MAIN	C1423

*The output level of a standard signal generator (SSG) is indicated as SSG's open circuit.

• MAIN UNIT

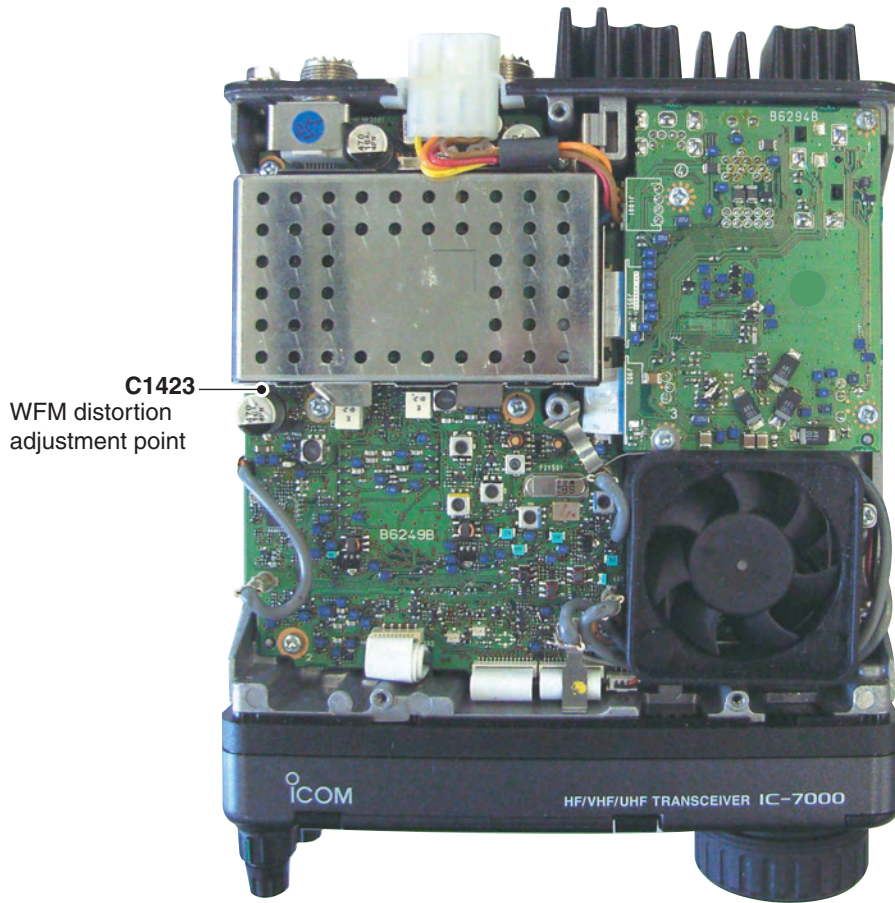

SECTION 5 PARTS LIST

[REPLACEMENT UNITS]

ORDER NO.	UNIT NAME
0324270102	U 7000 #02 FRONT [EUR], [FRA], [ESP], [EXP], [UK]
0324270105	U 7000 #05 FRONT [USA]

[FRONT UNIT]

REF NO.	ORDER NO.	DESCRIPTION	M.	H/V LOCATION
DS1	5030002820	LCD LTA025A161A		
W1	8900013940	CBL OPC-1447 (N=10, L=30)		
W2	8900013990	CBL OPC-1445		
EP1	880001670	UBD EX-2822 #01		

[DISPLAY UNIT]

REF NO.	ORDER NO.	DESCRIPTION	M.	H/V LOCATION
IC1	6910016730	S.DCC XC9504B092ARN	B	44.4/9.4
IC101	1180001071	S.IC TA7805F (TE16L, Q)	B	90.3/6.9
IC151	1180002201	S.IC RN5RZ33BA-TR-F	B	99.9/4.8
IC301	1110002751	S.IC TA75S01F (TE85R, F)	B	113.8/7.5
IC506	1120003010	S.IC AN2533FH-V	B	69/38.5
IC651	1110005420	S.IC BA15532F-E2	B	4.1/25.6
IC2003	1140013140	S.IC HD64338020SB68HV	B	93/26.3
IC2007	1110005821	S.IC R3112N281A-TR-F	B	108.7/46.9
Q1	1550000090	S.FET RSQ035P03TR	B	39.4/9.8
Q51	1560001330	S.FET RSR025N03	B	52.1/10.6
Q301	1560001290	S.FET 2SK3065 T100	T	110.8/31.4
Q302	1590003520	S.TR BCR108T	T	116.7/10.2
Q303	1590003530	S.TR BCR08PN	T	113.1/11.5
Q651	1590001650	S.TR XP4601 (TX)	B	10.6/28.8
Q652	1590001650	S.TR XP4601 (TX)	B	11.1/20.6
Q653	1590001650	S.TR XP4601 (TX)	B	10.6/26.2
Q654	1590001650	S.TR XP4601 (TX)	B	11.1/17
Q701	1530002060	S.TR 2SC4081 T106 R	T	19.1/50.3
Q721	1530002060	S.TR 2SC4081 T106 R	T	22/5.8
Q741	1530002060	S.TR 2SC4081 T106 R	T	94/50.1
Q761	1530002060	S.TR 2SC4081 T106 R	T	104.2/50.1
Q771	1530002060	S.TR 2SC4081 T106 R	T	18.4/25.1
Q781	1530002060	S.TR 2SC4081 T106 R	T	5.3/23.6
Q802	1520000460	S.TR 2SB1132 T100 R	B	58.8/21.6
Q2001	1590003520	S.TR BCR108T	B	81.6/23.7
Q2002	1590003570	S.TR BCR183T	B	81.2/30.1
D1	1790000970	S.DIO MA729 (TX)	B	36.8/10.1
D51	1750000730	S.DIO MA2SD1000L	B	51/8
D301	1790001250	S.DIO MA2S111-(TX)	B	111/32
D302	1790001520	S.ZEN MA8075-L (TX)	B	109.9/7.6
D601	1750000950	S.DIO MA732 (TX)	B	51.5/40
D602	1750000950	S.DIO MA732 (TX)	B	53.3/40
D801	1730002340	S.ZEN MA8047-M (TX)	B	35/40.4
D802	1730002340	S.ZEN MA8047-M (TX)	B	39.8/25.8
D803	1730002340	S.ZEN MA8047-M (TX)	B	38.6/22
D804	1730002340	S.ZEN MA8047-M (TX)	B	41.8/23
D2001	1750000950	S.DIO MA732 (TX)	T	107.4/26.5
D2002	1790001670	S.DIO RB706F-40T106	B	76.6/16.8
D2003	1790001670	S.DIO RB706F-40T106	T	116.4/36.7
D2004	1750000370	S.DIO DA221 TL	T	100.6/41.8
D2005	1750000370	S.DIO DA221 TL	B	101.7/42.8
D2006	1750000370	S.DIO DA221 TL	B	107.3/5.9
X501	6050012140	S.XTL CR-805 [USA]	B	87/43.5
X2001	6050012150	S.XTL CR-806 [Others]	B	87/43.5
X2001	6050011550	S.XTL CR-747	B	106.5/27

[DISPLAY UNIT]

REF NO.	ORDER NO.	DESCRIPTION	M.	H/V LOCATION
L1	6190001561	S.COL CDRH5D18NP-101NC	B	68.4/6.3
L2	6190001561	S.COL CDRH5D18NP-101NC	B	34.6/5.2
L3	6200002041	S.COL NLV25T-101J	B	30.7/10.4
L51	6190001561	S.COL CDRH5D18NP-101NC	B	55.9/6.2
L53	6200002041	S.COL NLV25T-101J	B	60.9/10.9
L101	6200001831	S.COL NLV32T-100J	B	96/11.6
L151	6200001831	S.COL NLV32T-100J	B	96/8.6
L152	6200001831	S.COL NLV32T-100J	B	100.6/11.4
L251	6200003950	S.COL HF50ACC 322513-T	B	145.9/44
L252	6200003950	S.COL HF50ACC 322513-T	B	146/50.6
L301	6200002041	S.COL NLV25T-101J	B	109.6/16.7
L302	6200005011	S.COL NLV25T-100J	T	112.6/24
L303	6200002041	S.COL NLV25T-101J	T	112/20.3
L306	6200003261	S.COL NLV32T-101J	T	109.8/25.5
L307	6200002041	S.COL NLV25T-101J	T	115.4/26.4
L309	6200002041	S.COL NLV25T-101J	T	115.3/24
L310	6200002041	S.COL NLV25T-101J	T	115.4/21.5
L312	6200002041	S.COL NLV25T-101J	T	115.4/19
L313	6200002041	S.COL NLV25T-101J	T	115.7/16.3
L505	6200005521	S.COL NLV25T-470J	B	71.2/47.9
L506	6200005011	S.COL NLV25T-100J	B	67.9/20.2
L507	6200005011	S.COL NLV25T-100J	B	50.2/29
L508	6200005011	S.COL NLV25T-100J	B	49.3/24.3
L509	6200005011	S.COL NLV25T-100J	B	17.4/35.6
L601	6200002041	S.COL NLV25T-101J	B	70.6/25.2
L602	6200005011	S.COL NLV25T-100J	B	53.5/36.2
L603	6200005011	S.COL NLV25T-100J	B	51/43.6
L604	6200005011	S.COL NLV25T-100J	B	53.5/43.6
L605	6200005011	S.COL NLV25T-100J	B	50.9/36.2
L651	6200002041	S.COL NLV25T-101J	B	19.1/42.7
L701	6200002041	S.COL NLV25T-101J	B	21.1/37.5
L702	6200002041	S.COL NLV25T-101J	B	65.4/10.9
L703	6200002041	S.COL NLV25T-101J	B	27.9/11.3
L801	6200005011	S.COL NLV25T-100J	B	63.4/16.9
L802	6200002041	S.COL NLV25T-101J	B	19.1/47.5
L851	6200003950	S.COL HF50ACC 322513-T	B	33.2/17.2
L852	6200003950	S.COL HF50ACC 322513-T	B	35/21.3
L853	6200002041	S.COL NLV25T-101J	B	34.4/26.6
L854	6200002041	S.COL NLV25T-101J	B	34.4/24.1
L855	6200003950	S.COL HF50ACC 322513-T	B	36.4/17.2
R1	7030008141	S.RES ERA3YKD 224V (220 kΩ)	B	33.4/9.6
R2	7030005671	S.RES ERA3YKD 393V (39 kΩ)	B	33.4/11.6
R3	7030008051	S.RES ERA3YKD 184V (180 kΩ)	B	42.6/6.4
R4	7030005050	S.RES ERJ2GEJ 103 X (10 kΩ)	B	40.9/6.8
R5	7030005050	S.RES ERJ2GEJ 103 X (10 kΩ)	B	40.9/7.7
R51	7030008141	S.RES ERA3YKD 224V (220 kΩ)	B	49.7/10.8
R52	7030007911	S.RES ERA3YKD 563V (56 kΩ)	B	48.5/10.8
R53	7030006561	S.RES ERA3YED 223V (22 kΩ)	B	46.5/11.8
R54	7030005050	S.RES ERJ2GEJ 103 X (10 kΩ)	B	47.9/8.4
R55	7030005050	S.RES ERJ2GEJ 103 X (10 kΩ)	B	48.8/8.4
R201	7030010040	S.RES ERJ2GEJ-JPW	B	109.6/38
R202	7030010040	S.RES ERJ2GEJ-JPW	B	109.6/39
R251	7030005120	S.RES ERJ2GEJ 102 X (1 kΩ)	B	136.5/49.6
R252	7030000300	S.RES MCR10EZHZ 220 Ω	B	133.9/47.3
R253	7030000300	S.RES MCR10EZHZ 220 Ω	B	142/50.8
R254	7030000300	S.RES MCR10EZHZ 220 Ω	B	133.9/49
R255	7030000300	S.RES MCR10EZHZ 220 Ω	T	143.2/50.7
R301	7030005120	S.RES ERJ2GEJ 102 X (1 kΩ)	B	113.2/32
R302	7030005050	S.RES ERJ2GEJ 103 X (10 kΩ)	T	114/30.4
R303	7030005120	S.RES ERJ2GEJ 102 X (1 kΩ)	B	111/33.4
R304	7030007300	S.RES ERJ2GEJ 332 X (3.3 kΩ)	B	111.9/33.4
R305	7030007300	S.RES ERJ2GEJ 332 X (3.3 kΩ)	B	113.2/32.9
R306	7030005120	S.RES ERJ2GEJ 102 X (1 kΩ)	T	114.9/11
R307	7030005050	S.RES ERJ2GEJ 103 X (10 kΩ)	B	111.3/8.4
R308	7030005230	S.RES ERJ2GEJ 334 X (330 kΩ)	B	113.8/5.3
R309	7030005310	S.RES ERJ2GEJ 124 X (120 kΩ)	B	112/5.3
R310	7030008010	S.RES ERJ2GEJ 123 X (12 kΩ)	B	110.2/5.3
R521	7030008370	S.RES ERJ2GEJ 561 X (560 Ω)	B	60.8/46.1
R522	7030010040	S.RES ERJ2GEJ-JPW	B	65.3/47.4
R523	7030010040	S.RES ERJ2GEJ-JPW	B	65.4/48.7
R524	7030010900	S.RES ERJ3GEYJ 750 V (75 Ω)	B	63.1/48.9
R528	7030010040	S.RES ERJ2GEJ-JPW	B	60.8/42.6
R529	7030005050	S.RES ERJ2GEJ 103 X (10 kΩ)	B	58.6/43.8
R530	7030005080	S.RES ERJ2GEJ 823 X (82 kΩ)	B	60.8/43.6
R531	7030009290	S.RES ERJ2GEJ 562 X (5.6 kΩ)	B	76.3/42.9
R532	7030005050	S.RES ERJ2GEJ 103 X (10 kΩ)	B	60.8/37.2
R533	7030010040	S.RES ERJ2GEJ-JPW	B	56.5/32.3
R534	7030010040	S.RES ERJ2GEJ-JPW	B	60.8/36
R536	7030010040	S.RES ERJ2GEJ-JPW	B	62.6/29
R537	7030010040	S.RES ERJ2GEJ-JPW	B	64.6/29
R538	7030010040	S.RES ERJ2GEJ-JPW	B	66.6/29

M.=Mounted side (T: Mounted on the Top side, B: Mounted on the Bottom side)
S.=Surface mount

[DISPLAY UNIT]

REF NO.	ORDER NO.	DESCRIPTION	M.	H/V LOCATION
R539	7030005720	S.RES ERJ2GEJ 563 X (56 kΩ)	B	69.6/29
R540	7030010040	S.RES ERJ2GEJ-JPW	B	68.6/29
R541	7310004650	S.TRI EVM-2WSX80 B53	B	53.3/49.2
R544	7030010040	S.RES ERJ2GEJ-JPW	B	60.8/39.6
R545	7030005720	S.RES ERJ2GEJ 563 X (56 kΩ)	B	60.8/32
R546	7030010040	S.RES ERJ2GEJ-JPW	B	60.8/34
R547	7030010040	S.RES ERJ2GEJ-JPW	B	59.2/34.8
R548	7030010040	S.RES ERJ2GEJ-JPW	B	60.8/33
R549	7030010040	S.RES ERJ2GEJ-JPW	B	63.6/29
R550	7030010040	S.RES ERJ2GEJ-JPW	B	65.6/29
R551	7030010040	S.RES ERJ2GEJ-JPW	B	67.6/29
R553	7030010040	S.RES ERJ2GEJ-JPW	B	59.5/43.8
R601	7030008410	S.RES ERJ2GEJ 392 X (3.9 kΩ)	B	72.7/24.9
R602	7030008410	S.RES ERJ2GEJ 392 X (3.9 kΩ)	B	74.5/24.9
R603	7030008410	S.RES ERJ2GEJ 392 X (3.9 kΩ)	B	75.4/24.9
R604	7030008410	S.RES ERJ2GEJ 392 X (3.9 kΩ)	B	77.2/24.9
R605	7030008410	S.RES ERJ2GEJ 392 X (3.9 kΩ)	B	75.3/30.2
R606	7030008410	S.RES ERJ2GEJ 392 X (3.9 kΩ)	B	76.3/24.9
R608	7030010040	S.RES ERJ2GEJ-JPW	B	48.8/36.8
R609	7030005040	S.RES ERJ2GEJ 472 X (4.7 kΩ)	B	48.8/45.3
R610	7030010040	S.RES ERJ2GEJ-JPW	B	48.8/42.3
R612	7030005040	S.RES ERJ2GEJ 472 X (4.7 kΩ)	B	48.8/43.3
R651	7030005050	S.RES ERJ2GEJ 103 X (10 kΩ)	B	5.5/19.6
R652	7030005220	S.RES ERJ2GEJ 223 X (22 kΩ)	B	0.8/25.7
R653	7030005060	S.RES ERJ2GEJ 333 X (33 kΩ)	B	5.5/21.4
R654	7030005070	S.RES ERJ2GEJ 683 X (68 kΩ)	B	0.8/23.9
R655	7030005090	S.RES ERJ2GEJ 104 X (100 kΩ)	B	4.1/30.7
R656	7030005110	S.RES ERJ2GEJ 224 X (220 kΩ)	B	0.8/27.4
R657	7030005060	S.RES ERJ2GEJ 333 X (33 kΩ)	B	1.8/30.3
R658	7030005090	S.RES ERJ2GEJ 104 X (100 kΩ)	B	4.1/29.8
R659	7030003600	S.RES ERJ3GEVJ 223 V (22 kΩ)	B	8.4/28.5
R660	7030005720	S.RES ERJ2GEJ 563 X (56 kΩ)	B	13.2/29.9
R661	7030005220	S.RES ERJ2GEJ 223 X (22 kΩ)	B	13.7/27.1
R662	7030007350	S.RES ERJ2GEJ 393 X (39 kΩ)	B	13.7/28.7
R663	7030005220	S.RES ERJ2GEJ 223 X (22 kΩ)	B	13.2/20.6
R664	7030007340	S.RES ERJ2GEJ 153 X (15 kΩ)	B	5.7/29.8
R665	7030003600	S.RES ERJ3GEVJ 223 V (22 kΩ)	B	8.9/20.6
R666	7030004980	S.RES ERJ2GEJ 101 X (100 Ω)	B	13.1/25.3
R667	7030004980	S.RES ERJ2GEJ 101 X (100 Ω)	B	11.1/18.8
R668	7030004980	S.RES ERJ2GEJ 101 X (100 Ω)	B	9.7/24.2
R669	7030004980	S.RES ERJ2GEJ 101 X (100 Ω)	B	13.6/16.2
R701	7030004990	S.RES ERJ2GEJ 221 X (220 Ω)	T	18.4/48
R702	7030007280	S.RES ERJ2GEJ 331 X (330 Ω)	T	19.7/48
R703	7030007290	S.RES ERJ2GEJ 222 X (2.2 kΩ)	T	25.1/41
R704	7030005040	S.RES ERJ2GEJ 472 X (4.7 kΩ)	T	16.6/17.2
R705	7030007340	S.RES ERJ2GEJ 153 X (15 kΩ)	T	18.7/6.4
R721	7030004990	S.RES ERJ2GEJ 221 X (220 Ω)	T	20.2/6.2
R722	7030007280	S.RES ERJ2GEJ 331 X (330 Ω)	T	23.8/5.6
R723	7030003480	S.RES ERJ3GEVJ 222 V (2.2 kΩ)	T	47.5/2.4
R724	7030003520	S.RES ERJ3GEVJ 472 V (4.7 kΩ)	T	61.8/2.4
R725	7030003580	S.RES ERJ3GEVJ 153 V (15 kΩ)	T	75.9/2.4
R741	7030004990	S.RES ERJ2GEJ 221 X (220 Ω)	T	92.2/49.7
R742	7030007280	S.RES ERJ2GEJ 331 X (330 Ω)	T	95.7/49.6
R743	7030007290	S.RES ERJ2GEJ 222 X (2.2 kΩ)	T	102.1/35
R744	7030005040	S.RES ERJ2GEJ 472 X (4.7 kΩ)	T	102.1/25.5
R745	7030007340	S.RES ERJ2GEJ 153 X (15 kΩ)	T	100.6/8.6
R761	7030004990	S.RES ERJ2GEJ 221 X (220 Ω)	T	103.1/48.2
R762	7030007280	S.RES ERJ2GEJ 331 X (330 Ω)	T	104.8/47.8
R771	7030004990	S.RES ERJ2GEJ 221 X (220 Ω)	T	18.7/28.9
R772	7030007280	S.RES ERJ2GEJ 331 X (330 Ω)	T	18.1/29.9
R781	7030004990	S.RES ERJ2GEJ 221 X (220 Ω)	T	3.5/22.4
R782	7030007280	S.RES ERJ2GEJ 331 X (330 Ω)	T	3.5/24.2
R801	7030005240	S.RES ERJ2GEJ 473 X (47 kΩ)	B	62/21.8
R802	7030007270	S.RES ERJ2GEJ 151 X (150 Ω)	B	62/20
R803	7030005120	S.RES ERJ2GEJ 102 X (1 kΩ)	B	62/23.6
R2002	7030005240	S.RES ERJ2GEJ 473 X (47 kΩ)	T	110.4/40.7
R2003	7030005050	S.RES ERJ2GEJ 103 X (10 kΩ)	T	24.6/24.3
R2004	7030005050	S.RES ERJ2GEJ 103 X (10 kΩ)	T	24.6/26.3
R2005	7030005050	S.RES ERJ2GEJ 103 X (10 kΩ)	T	24.6/23.3
R2006	7030005050	S.RES ERJ2GEJ 103 X (10 kΩ)	T	24.6/25.3
R2007	7030007290	S.RES ERJ2GEJ 222 X (2.2 kΩ)	T	107.6/24.4
R2008	7030005220	S.RES ERJ2GEJ 223 X (22 kΩ)	B	78.2/18.4
R2009	7030005240	S.RES ERJ2GEJ 473 X (47 kΩ)	T	107.8/33
R2010	7030005090	S.RES ERJ2GEJ 104 X (100 kΩ)	B	79.6/16.9
R2011	7030005160	S.RES ERJ2GEJ 105 X (1 MΩ)	B	103.3/26.9
R2012	7030008010	S.RES ERJ2GEJ 123 X (12 kΩ)	B	103.3/23.3
R2013	7030005240	S.RES ERJ2GEJ 473 X (47 kΩ)	B	96.7/37.9
R2014	7030005290	S.RES ERJ2GEJ 682 X (6.8 kΩ)	T	24.1/41
R2015	7030005050	S.RES ERJ2GEJ 103 X (10 kΩ)	B	106/44.6
R2016	7030005240	S.RES ERJ2GEJ 473 X (47 kΩ)	B	92.1/37.9
R2017	7030005290	S.RES ERJ2GEJ 682 X (6.8 kΩ)	T	33.4/3.7
R2018	7030005290	S.RES ERJ2GEJ 682 X (6.8 kΩ)	T	102.2/41.8
R2019	7030005240	S.RES ERJ2GEJ 473 X (47 kΩ)	B	82/32.6
R2020	7030003450	S.RES ERJ3GEVJ 122 V (1.2 kΩ)	B	91.2/43.1
R2021	7030005240	S.RES ERJ2GEJ 473 X (47 kΩ)	B	97.1/40.8
R2022	7030005240	S.RES ERJ2GEJ 473 X (47 kΩ)	B	92.3/42.3
R2023	7030005240	S.RES ERJ2GEJ 473 X (47 kΩ)	B	100.1/42.8
R2024	7030005240	S.RES ERJ2GEJ 473 X (47 kΩ)	B	94.3/42.3
R2025	7030005240	S.RES ERJ2GEJ 473 X (47 kΩ)	B	93.3/42.3
R2026	7030005240	S.RES ERJ2GEJ 473 X (47 kΩ)	B	72.5/16.9
R2027	7030005240	S.RES ERJ2GEJ 473 X (47 kΩ)	B	70.6/16.9

[DISPLAY UNIT]

REF NO.	ORDER NO.	DESCRIPTION	M.	H/V LOCATION
R2028	7030005240	S.RES ERJ2GEJ 473 X (47 kΩ)	B	98.9/42.8
R2029	7030005240	S.RES ERJ2GEJ 473 X (47 kΩ)	B	73.5/16.9
R2030	7030007270	S.RES ERJ2GEJ 151 X (150 Ω)	T	108/11.8
R2031	7030007280	S.RES ERJ2GEJ 331 X (330 Ω)	T	108.8/40.1
R2033	7030007270	S.RES ERJ2GEJ 151 X (150 Ω)	T	19.4/20.3
R2034	7030005120	S.RES ERJ2GEJ 102 X (1 kΩ)	B	32.1/28.3
R2035	7030005120	S.RES ERJ2GEJ 102 X (1 kΩ)	B	32.5/30.9
R2036	7030005240	S.RES ERJ2GEJ 473 X (47 kΩ)	B	94.9/37.9
R2037	7030005240	S.RES ERJ2GEJ 473 X (47 kΩ)	B	93.9/37.9
R2039	7030005240	S.RES ERJ2GEJ 473 X (47 kΩ)	T	107.6/23.5
R2040	7030007340	S.RES ERJ2GEJ 153 X (15 kΩ)	B	116.3/8.7
R2041	7030007340	S.RES ERJ2GEJ 153 X (15 kΩ)	B	116.2/7.7
R2042	7030005050	S.RES ERJ2GEJ 103 X (10 kΩ)	B	81.6/31.7
C2	4030018960	S.CER C3216 JB 1C 106MT-N	B	62.2/7
C3	4030018960	S.CER C3216 JB 1C 106MT-N	B	77/9.8
C4	4030017420	S.CER ECJ0EC1H470J	B	35.3/10.6
C6	4030018960	S.CER C3216 JB 1C 106MT-N	B	28/6
C8	4030018960	S.CER C3216 JB 1C 106MT-N	B	30.1/6
C9	4030018960	S.CER C3216 JB 1C 106MT-N	B	39.1/4.4
C51	4030017420	S.CER ECJ0EC1H470J	B	49.7/8.4
C53	4030018960	S.CER C3216 JB 1C 106MT-N	B	51.6/4.3
C55	4030018960	S.CER C3216 JB 1C 106MT-N	B	56.2/11
C56	4030018960	S.CER C3216 JB 1C 106MT-N	B	61.9/3.6
C57	4030017490	S.CER C1608 JB 1A 105K-T	B	43.9/11.8
C101	4030018960	S.CER C3216 JB 1C 106MT-N	B	85.7/6.3
C102	4030018960	S.CER C3216 JB 1C 106MT-N	B	94.7/4.6
C103	4030016930	S.CER ECJ0EB1A104K	B	91.1/12.2
C104	4030016930	S.CER ECJ0EB1A104K	B	89.5/12.2
C151	4550006250	S.TAN TEESVA 1A 106M8R	B	97/4.6
C152	4550006250	S.TAN TEESVA 1A 106M8R	B	100.7/7.7
C153	4030016930	S.CER ECJ0EB1A104K	B	99.7/2.6
C154	4030016930	S.CER ECJ0EB1A104K	B	99.6/9.3
C251	4030017730	S.CER ECJ0EB1E471K	B	147.5/46.4
C252	4030017730	S.CER ECJ0EB1E471K	B	147.5/48.3
C253	4030017730	S.CER ECJ0EB1E471K	B	144.4/48.3
C254	4030017730	S.CER ECJ0EB1E471K	B	144.4/46.4
C301	4030017780	S.CER ECJ0EB1E472K	T	108.3/19.9
C302	4030017780	S.CER ECJ0EB1E472K	T	108.2/27.8
C303	4030006880	S.CER C1608 JB 1H 472K-T	T	113/27
C304	4030017780	S.CER ECJ0EB1E472K	B	113.2/33.8
C305	4030017780	S.CER ECJ0EB1E472K	T	114.9/12.6
C306	4030017780	S.CER ECJ0EB1E472K	B	113.8/4.3
C312	4030017780	S.CER ECJ0EB1E472K	T	108.2/29.6
C315	4030017780	S.CER ECJ0EB1E472K	B	25.2/19.9
C316	4030017780	S.CER ECJ0EB1E472K	B	26.1/19.9
C317	4030017780	S.CER ECJ0EB1E472K	B	27.1/19.9
C318	4030017780	S.CER ECJ0EB1E472K	B	23.9/19.8
C319	4030017780	S.CER ECJ0EB1E472K	B	27.2/32.5
C320	4030017780	S.CER ECJ0EB1E472K	B	26.3/32.5
C321	4030017780	S.CER ECJ0EB1E472K	B	25.5/31.1
C322	4030017780	S.CER ECJ0EB1E472K	B	24.6/27.3
C501	4550007140	S.TAN TEESVD 1C 107M12R	B	53.3/20.9
C502	4550007140	S.TAN TEESVD 1C 107M12R	B	45.3/20.9
C513	4030016930	S.CER ECJ0EB1A104K	B	64.3/47.4
C514	4030016930	S.CER ECJ0EB1A104K	B	63.3/47.4
C515	4030017490	S.CER C1608 JB 1A 105K-T	B	61.5/44.9
C516	4030018910	S.CER C1608 JB 0J 475K-T	B	67.7/48.9
C517	4030017490	S.CER C1608 JB 1A 105K-T	B	75.6/47.9
C518	4030017650	S.CER ECJ0EC1H270J	[Others]	73.4/47.4
	4030017670	S.CER ECJ0EC1H390J	[USA]	73.4/47.4
C519	4030016930	S.CER ECJ0EB1A104K	B	76.9/48.4
C520	4030016930	S.CER ECJ0EB1A104K	B	74.4/47.4
C521	4030018960	S.CER C3216 JB 1C 106MT-N	B	65.6/20.6
C522	4030016930	S.CER ECJ0EB1A104K	B	69.7/19.8
C523	4030018970	S.CER C3225 JB 1C 226MT-N	B	53.4/28.9
C524	4030017700	S.CER ECJ0EC1H151J	B	59/42.6
C525	4030016930	S.CER ECJ0EB1A104K	B	55.4/30.3
C526	4030018090	S.CER ECJ0EB1C822K	B	59.2/35.8
C527	4030018100	S.CER ECJ0EB1H681K	B	59/49.5
C528	4030017730	S.CER ECJ0EB1E471K	B	59/45
C529	4030018970	S.CER C3225 JB 1C 226MT-N	B	58.4/40
C530	4030016930	S.CER ECJ0EB1A104K	B	77.2/39.1
C531	4030018970	S.CER C3225 JB 1C 226MT-N	B	81.3/35.9
C532	4030016930	S.CER ECJ0EB1A104K	B	77.2/36.6
C533	4030017490	S.CER C1608 JB 1A 105K-T	B	77/44.5
C534	4030016970	S.CER ECJ0EB1C223K	B	77.5/42.5
C536	4610001850	S.TRI TZB4R200AB10R00	B	81/39.7
C537	4030016930	S.CER ECJ0EB1A104K	B	77.2/40.1
C538	4030016930	S.CER ECJ0EB1A104K	B	77.2/37.6
C539	4030018910	S.CER C1608 JB 0J 475K-T	B	77.7/34.9
C540	4030018910	S.CER C1608 JB 0J 475K-T	B	58.5/37
C541	4030018970	S.CER C3225 JB 1C 226MT-N	B	59.2/28.9
C542	4030018910	S.CER C1608 JB 0J 475K-T	B	77.7/33.6
C543	4030018960	S.CER C3216 JB 1C 106MT-N	B	80/46.5
C544	4030018910	S.CER C1608 JB 0J 475K-T	B	77.7/32.3
C545	4030011600	S.CER C1608 JB 1E 104K-T	B	77/46.3
C549	4030018960	S.CER C3216 JB 1C 106MT-N	B	71.7/28.8
C550	4030018960	S.CER C3216 JB 1C 106MT-N	B	77/28.8
C551	4030018960	S.CER C3216 JB 1C 106MT-N	B	73.8/28.8

M.=Mounted side (T: Mounted on the Top side, B: Mounted on the Bottom side)
S.=Surface mount

[DISPLAY UNIT]

REF NO.	ORDER NO.	DESCRIPTION	M.	H/V LOCATION
C559	4030017460	S.CER ECJ0EB1E102K	B	29.3/43.9
C560	4030018960	S.CER C3216 JB 1C 106MT-N	B	17/33.2
C561	4030017330	S.CER ECJ0EB1C104Z	B	7.3/30.7
C562	4030017780	S.CER ECJ0EB1E472K	B	6.1/30.9
C601	4030016930	S.CER ECJ0EB1A104K	B	73.6/24.9
C602	4030016930	S.CER ECJ0EB1A104K	B	48.8/44.3
C603	4030016930	S.CER ECJ0EB1A104K	B	55/39.4
C604	4030018960	S.CER C3216 JB 1C 106MT-N	B	55.8/36.3
C605	4030016930	S.CER ECJ0EB1A104K	B	52.5/46.6
C606	4030018960	S.CER C3216 JB 1C 106MT-N	B	50.7/48
C607	4030011600	S.CER C1608 JB 1E 104K-T	B	55.4/40.6
C608	4030018960	S.CER C3216 JB 1C 106MT-N	B	55.8/43.7
C609	4030011600	S.CER C1608 JB 1E 104K-T	B	50.5/31.8
C610	4030018960	S.CER C3216 JB 1C 106MT-N	B	52.3/33.5
C611	4550007220	S.TAN F931A476MCMCMBMA	B	73.4/22.1
C651	4030018960	S.CER C3216 JB 1C 106MT-N	B	16.9/17.6
C652	4030018960	S.CER C3216 JB 1C 106MT-N	B	6.7/17.1
C653	4030011600	S.CER C1608 JB 1E 104K-T	B	15.7/19.3
C654	4030017490	S.CER C1608 JB 1A 105K-T	B	3.5/20.4
C655	4030016790	S.CER ECJ0EB1C103K	B	0.8/30.3
C656	4030019090	S.CER C2012 JB 1C 225M-T	B	7.8/25.5
C657	4030018520	S.CER C1608 JB 0J 225M-T	B	7/20.6
C658	4030017650	S.CER ECJ0EB1H270J	B	5.5/20.5
C659	4030017780	S.CER ECJ0EB1E472K	B	15.2/20.3
C701	4030018960	S.CER C3216 JB 1C 106MT-N	B	4.6/32.4
C702	4030018960	S.CER C3216 JB 1C 106MT-N	B	48.9/19
C801	4030016930	S.CER ECJ0EB1A104K	B	62.9/19.7
C802	4030011600	S.CER C1608 JB 1E 104K-T	B	21.5/48.5
C851	4030017780	S.CER ECJ0EB1E472K	B	32.1/23.9
C852	4030018960	S.CER C3216 JB 1C 106MT-N	B	40.3/15.8
C2001	4030018520	S.CER C1608 JB 0J 225M-T	B	78.5/16.7
C2002	4030017780	S.CER ECJ0EB1E472K	T	114.8/34.7
C2003	4030017630	S.CER ECJ0EB1H120J	B	103.3/28.7
C2004	4030017630	S.CER ECJ0EB1H120J	B	103.3/25.1
C2005	4030016790	S.CER ECJ0EB1C103K	B	103.3/35.7
C2006	4030016930	S.CER ECJ0EB1A104K	B	98/37.9
C2007	4030018960	S.CER C3216 JB 1C 106MT-N	B	105.8/47.7
C2008	4030017030	S.CER ECJ0EB1A273K	B	109.7/44.6
C2009	4030016930	S.CER ECJ0EB1A104K	B	99/37.9
C2010	4030016930	S.CER ECJ0EB1A104K	B	100/37.9
C2011	4030016930	S.CER ECJ0EB1A104K	B	79.6/29.7
C2012	4030017780	S.CER ECJ0EB1E472K	B	95.8/37.9
C2013	4030017780	S.CER ECJ0EB1E472K	B	93/37.9
C2014	4030016930	S.CER ECJ0EB1A104K	T	110.4/41.7
C2015	4030016930	S.CER ECJ0EB1A104K	B	103.3/35.7
C2016	4030016930	S.CER ECJ0EB1A104K	B	83.5/28
J202	6510023801	S.CNR S4B-ZR-SM4A-TF (LF) (SN)	B	115.9/39.4
J251	6510024680	S.CNR HSJ1636-011020	B	154.7/45.8
J303	6510021431	S.CNR S8B-ZR-SM4A-TF (LF) (SN)	B	115.9/20.9
J401	6510024840	S.CNR S2746-1070	B	21.3/26.3
J601	6510024780	S.CNR S2437-2472	B	45.1/42
J2001	6510024790	S.CNR S2559-1072	B	96.9/47.6
DS805	5040003190	S.LED NSSW008B	T	29.5/39.4
DS806	5040003190	S.LED NSSW008B	T	29.4/31.4
DS807	5040003190	S.LED NSSW008B	T	29.4/24.1
DS808	5040003190	S.LED NSSW008B	T	29.5/16.1
DS2001	5040002930	S.LED SML-512MW T86	T	110.2/15.8
DS2002	5040002020	S.LED CL-170UR-CD-T	T	110.2/36.8
DS2004	5040002930	S.LED SML-512MW T86	T	11.4/20.5
S201	2230001160	S.SW SPVP110100	T	157.7/34.3
S251	2220000330	S.SW HSW0880-01-210	B	139.7/46.5
S701	2230001150	S.SW LS9J2M-1FG-T	T	22.2/48.3
S702	2230001150	S.SW LS9J2M-1FG-T	T	21.7/36.5
S703	2230001150	S.SW LS9J2M-1FG-T	T	20.9/17
S704	2230001150	S.SW LS9J2M-1FG-T	T	21.6/2.7
S721	2230001150	S.SW LS9J2M-1FG-T	T	40.1/2.4
S722	2230001150	S.SW LS9J2M-1FG-T	T	54.3/2.4
S723	2230001150	S.SW LS9J2M-1FG-T	T	68.4/2.4
S724	2230001150	S.SW LS9J2M-1FG-T	T	82.6/2.4
S741	2230001150	S.SW LS9J2M-1FG-T	T	98.1/47.8
S742	2230001150	S.SW LS9J2M-1FG-T	T	99.1/32.1
S743	2230001150	S.SW LS9J2M-1FG-T	T	99.1/20.5
S744	2230001150	S.SW LS9J2M-1FG-T	T	98.1/5.7
S761	2230001150	S.SW LS9J2M-1FG-T	T	109.5/49.1
S762	2230001150	S.SW LS9J2M-1FG-T	T	109.5/3.5
S763	2230001150	S.SW LS9J2M-1FG-T	T	154.8/47.4
S764	2230001150	S.SW LS9J2M-1FG-T	T	154.8/5.1
S781	2230001150	S.SW LS9J2M-1FG-T	T	4.6/29
S782	2230001150	S.SW LS9J2M-1FG-T	T	21.7/25.8
EP1	6910014730	S.BEA MPZ2012S331A-T	B	64.1/6.6
R1	7210003230	VAR TP96D00A-17F-10KBX2		

[VR UNIT]

REF NO.	ORDER NO.	DESCRIPTION	M.	H/V LOCATION
R2	7030003860	S.RES ERJ3GE JPW V	T	1.3/32.6
R3	7030003860	S.RES ERJ3GE JPW V	T	2.3/30
J1	6510024850	S.CNR 54550-1094	T	3.3/22.2
S1	2250000170	ECR TP90D96AE20-17F (1352)		
EP4	6910012350	S.BEA MMZ1608Y 102BT	T	2.7/32.6
EP5	6910012350	S.BEA MMZ1608Y 102BT	T	3.7/30
EP6	6910012350	S.BEA MMZ1608Y 102BT	T	0.9/30
EP7	6910012350	S.BEA MMZ1608Y 102BT	T	0.9/14.5
EP8	6910012350	S.BEA MMZ1608Y 102BT	T	3.7/14.5
EP9	6910012350	S.BEA MMZ1608Y 102BT	T	2.7/11.8
EP10	6910012350	S.BEA MMZ1608Y 102BT	T	2.3/14.5
EP11	6910012350	S.BEA MMZ1608Y 102BT	T	1.3/11.8

[MAIN UNIT]

REF NO.	ORDER NO.	DESCRIPTION	M.	H/V LOCATION
IC1	1110004080	S.IC μPC2709T-E3	T	75.6/12.7
IC2	1110004101	S.IC TA4001F (TE85L,F)	T	63.9/18.8
IC3	1110004091	S.IC TA4002F (TE85L,F)	T	48.3/17.4
IC401	1190002051	S.IC SPM5001-YL-E	T	77.5/27.9
IC421	1110004080	S.IC μPC2709T-E3	T	86.4/19.4
IC801	1110004080	S.IC μPC2709T-E3	T	86/57.4
IC1101	1110006730	S.IC NJM2594V-TE1	T	5/83.3
IC1201	1130006221	S.IC TC4W53FU (TE12L,F)	T	24.2/81.6
IC1202	1130006221	S.IC TC4W53FU (TE12L,F)	T	19.8/81.4
IC1203	1110006570	S.IC TS462CPT	T	12.8/81.7
IC1301	1110005461	S.IC TA4107F (TE12L,F)	T	13.7/63.4
IC1401	1110006541	S.IC LA1225M-TLM-E	B	23.4/82.2
IC1501	1110006530	S.IC TA4019F (TE12L,F)	B	74.8/39
IC1502	1110005040	S.IC M52342FP 600C	B	79.7/57
IC1601	1110005320	S.IC NJM13403V-TE1	T	8.6/41.5
IC1801	1180002020	S.REG BA033FP-E2	B	22.8/106.5
IC1901	1180001251	S.IC TA7808F (TE16L,Q)	B	10.4/55.2
IC1951	1190002120	S.IC XC9201D09AKR	B	41.9/107.8
IC1952	1180002020	S.REG BA033FP-E2	B	14.7/125.8
IC2001	1180001251	S.IC TA7808F (TE16L,Q)	B	8.5/19
IC2007	1110006570	S.IC TS462CPT	T	15.8/121
IC2101	1110005320	S.IC NJM13403V-TE1	T	28.5/118.2
IC2102	1110005320	S.IC NJM13403V-TE1	T	49.5/111.9
IC2103	1110005140	S.IC NJM3403AV-TE1	T	49.5/121.2
IC2151	1130012720	S.IC CD74HC4094PWR	T	47.1/95.9
IC2152	1130012720	S.IC CD74HC4094PWR	T	37.9/95.9
IC2153	1130012720	S.IC CD74HC4094PWR	T	28.1/95.8
IC2154	1130012720	S.IC CD74HC4094PWR	T	28.2/101.5
IC2155	1110006680	S.IC BH2221FV-E2	T	38.2/118.1
IC2156	1130009100	S.IC BU4052BCFV-E2	T	10.1/107.6
IC2231	1110006640	S.IC NJM2244M-TE1	T	34.7/109.4
IC2251	1130008510	S.IC TC7W53FU (TE12L)	T	16.7/89.5
IC2501	1110006570	S.IC TS462CPT	B	12.7/91.7
IC2551	1110006570	S.IC TS462CPT	B	49.2/122
IC2601	1130006221	S.IC TC4W53FU (TE12L,F)	B	63.2/123.9
IC2602	1110003091	IC LA4425A-E		
Q101	1530003091	S.TR 2SC4213-B (TE85R,F)	T	11.2/17.5
Q102	1590003520	S.TR BCR108T	T	21.3/5.6
Q103	1590003530	S.TR BCR08PN	T	38.4/20.2
Q201	1590003520	S.TR BCR108T	T	16.1/31.1
Q202	1590003520	S.TR BCR108T	T	23.5/28.5
Q204	1590003520	S.TR BCR108T	B	44.7/38.6
Q205	1590003520	S.TR BCR108T	T	42.9/61.5
Q206	1590003520	S.TR BCR108T	B	24.5/55
Q207	1590003520	S.TR BCR108T	B	24.5/51.9
Q208	1590003520	S.TR BCR108T	B	24.2/48.8
Q209	1590003520	S.TR BCR108T	B	23.5/45.7
Q210	1590003520	S.TR BCR108T	B	42.9/41.4
Q211	1530003851	S.TR 2SC5551F-TD-E	T	26.7/30.1
Q301	1530003851	S.TR 2SC5551F-TD-E	T	56.7/32.4
Q402	1590003530	S.TR BCR08PN	T	82.8/22.8
Q403	1590003530	S.TR BCR08PN	T	70.6/23.6
Q502	1530003851	S.TR 2SC5551F-TD-E	T	82.8/37.1
Q701	1580000780	S.FET 3SK195 (TE85L,F)	T	62/56.5
Q702	1580000780	S.FET 3SK195 (TE85L,F)	T	54.6/51.8
Q901	1580000780	S.FET 3SK195 (TE85L,F)	T	36.6/65.7
Q902	1580000780	S.FET 3SK195 (TE85L,F)	T	35.9/73.2
Q1001	1580000780	S.FET 3SK195 (TE85L,F)	T	17.9/76
Q1201	1590003530	S.TR BCR08PN	T	28/78.6
Q1401	1530002060	S.TR 2SC4081 T106 R	B	42.5/74.3

M.=Mounted side (T: Mounted on the Top side, B: Mounted on the Bottom side)
S.=Surface mount

[MAIN UNIT]

REF NO.	ORDER NO.	DESCRIPTION	M.	H/V LOCATION
Q1402	1530002060	S.TR 2SC4081 T106 R	B	36.7/80.1
Q1501	1590003530	S.TR BCR08PN	T	30.6/78.5
Q1521	1530002060	S.TR 2SC4081 T106 R	B	86.6/48.6
Q1601	1530003091	S.TR 2SC4213-B (TE85R,F)	T	8.3/52.9
Q1602	1590001870	S.TR DTA114EE TL	T	4.5/53
Q1603	1590003520	S.TR BCR108T	T	2.8/40.7
Q1604	1510000771	S.TR 2SA1586-GR (TE85R,F)	T	5.1/32.7
Q1606	1560001260	S.FET 2SK3018 T106	T	12.5/36.8
Q1701	1540000441	S.TR 2SD1619T-TD-E	B	52.4/48.2
Q1702	1590003520	S.TR BCR108T	B	54.3/52.1
Q1703	1540000441	S.TR 2SD1619T-TD-E	B	52.4/67.4
Q1704	1590003520	S.TR BCR108T	B	54.1/72.9
Q1901	1590003530	S.TR BCR08PN	T	35.8/78.5
Q1902	1590003530	S.TR BCR08PN	T	33.3/78.5
Q1903	1590003530	S.TR BCR08PN	B	23.6/17
Q1904	1590003530	S.TR BCR08PN	B	32.9/87.9
Q1905	1590003530	S.TR BCR08PN	B	46/40.9
Q1906	1590003530	S.TR BCR08PN	B	26.3/30.8
Q1907	1590003530	S.TR BCR08PN	T	40.9/78.5
Q1908	1590003530	S.TR BCR08PN	T	38.3/78.5
Q1909	1590003530	S.TR BCR08PN	B	22.1/11.8
Q1960	1550000090	S.FET RSQ035P03TR	B	37.9/103.6
Q2150	1590003530	S.TR BCR08PN	T	48.4/100.1
Q2151	1520000460	S.TR 2SB1132 T100 R	T	55.3/103.8
Q2152	1520000460	S.TR 2SB1132 T100 R	T	21.3/111
Q2153	1520000460	S.TR 2SB1132 T100 R	T	49.8/104.5
Q2154	1590003530	S.TR BCR08PN	T	44.7/100.1
Q2155	1590003530	S.TR BCR08PN	T	39.9/100.1
Q2156	1590003520	S.TR BCR108T	T	58.9/104.5
Q2157	1590003520	S.TR BCR108T	T	25.4/109.7
Q2158	1590003520	S.TR BCR108T	T	45.5/107.1
Q2159	1590003530	S.TR BCR08PN	T	6.7/18.2
Q2160	1590003530	S.TR BCR08PN	T	7.7/122.2
Q2231	1590003520	S.TR BCR108T	T	4.7/121.7
Q2232	1590003530	S.TR BCR08PN	T	57.3/114.8
Q2233	1590003530	S.TR BCR08PN	T	54.7/115.7
Q2301	1530002060	S.TR 2SC4081 T106 R	T	30.6/109
Q2401	1540000441	S.TR 2SD1619T-TD-E	B	80.1/26.4
Q2601	1560001260	S.FET 2SK3018 T106	B	36.2/125.3
Q2602	1560001220	S.FET ECH8301-TL	B	37.3/128.2
Q2603	1530002060	S.TR 2SC4081 T106 R	T	65.3/111.3
Q2605	1590003520	S.TR BCR108T	T	11.7/112.7
Q2606	1540000451	S.TR 2SD1623T-TD-E	B	89.5/119.9
Q2607	1590003520	S.TR BCR108T	B	65.4/120.5
Q2608	1590003520	S.TR BCR108T	B	45/128.6
D1	1750000581	S.DIO 1SV307 (TPH3, F)	T	70.2/16.6
D2	1750000581	S.DIO 1SV307 (TPH3, F)	T	70.1/14.8
D3	1750000581	S.DIO 1SV307 (TPH3, F)	T	45.2/19.8
D4	1750000581	S.DIO 1SV307 (TPH3, F)	T	41.9/19
D5	1750000581	S.DIO 1SV307 (TPH3, F)	T	70.6/18.3
D6	1790000620	S.DIO MA77 (TX)	B	80.5/16.4
D7	1790000620	S.DIO MA77 (TX)	T	78.5/15.8
D8	1790000620	S.DIO MA77 (TX)	B	81.5/10.6
D9	1790000620	S.DIO MA77 (TX)	T	79/11.5
D10	1750000581	S.DIO 1SV307 (TPH3, F)	T	42.4/20.9
D101	1750000581	S.DIO 1SV307 (TPH3, F)	T	13.3/22.5
D102	1750000581	S.DIO 1SV307 (TPH3, F)	T	15.7/19.2
D103	1750000581	S.DIO 1SV307 (TPH3, F)	T	19.9/8.5
D104	1750000581	S.DIO 1SV307 (TPH3, F)	T	34.7/17.9
D105	1750000581	S.DIO 1SV307 (TPH3, F)	T	23.1/12.7
D106	1750000581	S.DIO 1SV307 (TPH3, F)	T	29.6/21
D107	1750000581	S.DIO 1SV307 (TPH3, F)	T	44/23.6
D108	1750000950	S.DIO MA732 (TX)	B	27.1/18.2
D109	1750000950	S.DIO MA732 (TX)	B	24.7/20.3
D110	1790001240	S.DIO MA2S728-(TX)	B	51.6/26.4
D111	1790001240	S.DIO MA2S728-(TX)	B	51.6/24.7
D112	1750000581	S.DIO 1SV307 (TPH3, F)	T	15.7/20.9
D113	1750000581	S.DIO 1SV307 (TPH3, F)	T	10.2/19.7
D114	1790001250	S.DIO MA2S111-(TX)	T	35.7/21.3
D203	1750000581	S.DIO 1SV307 (TPH3, F)	T	19.3/35.7
D204	1750000581	S.DIO 1SV307 (TPH3, F)	T	25.7/58.2
D205	1750000581	S.DIO 1SV307 (TPH3, F)	T	25.7/56.3
D208	1750000581	S.DIO 1SV307 (TPH3, F)	T	25.7/53.4
D209	1750000581	S.DIO 1SV307 (TPH3, F)	T	25.7/50.6
D210	1750000581	S.DIO 1SV307 (TPH3, F)	T	25.7/47.7
D211	1750000581	S.DIO 1SV307 (TPH3, F)	T	25.7/44.8
D212	1750000581	S.DIO 1SV307 (TPH3, F)	T	25.7/39.2
D213	1750000581	S.DIO 1SV307 (TPH3, F)	T	25.7/41.5
D214	1750000581	S.DIO 1SV307 (TPH3, F)	T	47.7/59.3
D215	1750000581	S.DIO 1SV307 (TPH3, F)	T	47.7/56.3
D216	1750000581	S.DIO 1SV307 (TPH3, F)	T	47.9/53.6
D217	1750000581	S.DIO 1SV307 (TPH3, F)	T	47.8/49.7
D218	1750000581	S.DIO 1SV307 (TPH3, F)	B	41.7/47.2
D219	1750000581	S.DIO 1SV307 (TPH3, F)	B	38.9/41.6
D220	1750000581	S.DIO 1SV307 (TPH3, F)	B	44.6/28.5
D221	1750000581	S.DIO 1SV307 (TPH3, F)	B	40.4/36
D301	1750000581	S.DIO 1SV307 (TPH3, F)	T	47.3/28.5
D302	1750000581	S.DIO 1SV307 (TPH3, F)	T	49.5/30.3
D303	1750000581	S.DIO 1SV307 (TPH3, F)	T	64/29.9

[MAIN UNIT]

REF NO.	ORDER NO.	DESCRIPTION	M.	H/V LOCATION
D304	1750000581	S.DIO 1SV307 (TPH3, F)	T	62.4/35.2
D305	1750000581	S.DIO 1SV307 (TPH3, F)	T	73.4/35.2
D306	1750000581	S.DIO 1SV307 (TPH3, F)	T	64.5/25.1
D501	1750000531	S.DIO 1SV271 (TPH3, F)	T	90.5/32.2
D502	1750000581	S.DIO 1SV307 (TPH3, F)	T	86.2/31.4
D503	1750000581	S.DIO 1SV307 (TPH3, F)	T	89.4/29.7
D504	1750000531	S.DIO 1SV271 (TPH3, F)	T	89.7/37.7
D505	1750000581	S.DIO 1SV307 (TPH3, F)	T	86.7/40.1
D506	1750000581	S.DIO 1SV307 (TPH3, F)	B	87.2/35.5
D601	1750000581	S.DIO 1SV307 (TPH3, F)	B	90/38.5
D602	1750000581	S.DIO 1SV307 (TPH3, F)	T	92.4/41.5
D603	1750000581	S.DIO 1SV307 (TPH3, F)	B	76.2/46.5
D604	1750000581	S.DIO 1SV307 (TPH3, F)	T	66.7/43.7
D701	1750000581	S.DIO 1SV307 (TPH3, F)	T	61.2/43.7
D702	1750000581	S.DIO 1SV307 (TPH3, F)	T	65.1/41.3
D703	1750000581	S.DIO 1SV307 (TPH3, F)	T	62.7/61.4
D704	1750000581	S.DIO 1SV307 (TPH3, F)	T	62.7/63.2
D801	1750000431	S.DIO HSB88WSTR-E	T	74.1/60.3
D802	1750000581	S.DIO 1SV307 (TPH3, F)	T	63/73.3
D803	1750000581	S.DIO 1SV307 (TPH3, F)	T	65.5/64.6
D903	1750000581	S.DIO 1SV307 (TPH3, F)	T	39.5/69.4
D904	1750000581	S.DIO 1SV307 (TPH3, F)	T	39.5/72.8
D1301	1750000581	S.DIO 1SV307 (TPH3, F)	T	12.8/72.6
D1302	1750000581	S.DIO 1SV307 (TPH3, F)	T	13.9/70.8
D1521	1750000531	S.DIO 1SV271 (TPH3, F)	B	79.4/40.7
D1522	1750000531	S.DIO 1SV271 (TPH3, F)	B	79.4/42.4
D1601	1790001240	S.DIO MA2S728-(TX)	T	15.1/48.7
D1602	1790001240	S.DIO MA2S728-(TX)	T	18.3/53.1
D1604	1790001250	S.DIO MA2S111-(TX)	T	7.7/31.5
D1605	1790001250	S.DIO MA2S111-(TX)	T	7.7/32.8
D1606	1790001250	S.DIO MA2S111-(TX)	T	14.1/44.8
D1607	1790001250	S.DIO MA2S111-(TX)	T	14.1/43.5
D1608	1790001250	S.DIO MA2S111-(TX)	T	14.1/42.2
D1609	1790001330	S.ZEN MA8036-L (TX)	T	7.5/29.9
D1610	1790001250	S.DIO MA2S111-(TX)	T	12.3/34.9
D1701	1790001670	S.DIO RB706F-40T106	B	50.2/52.2
D1702	1790001670	S.DIO RB706F-40T106	B	51.8/71.8
D1951	1750001110	S.DIO SM240A-T	B	36.2/99.9
D2151	1790001250	S.DIO MA2S111-(TX) [USA] only	T	39/87.1
D2153	1790001250	S.DIO MA2S111-(TX) [USA] only	T	36.5/87.1
D2154	1790001250	S.DIO MA2S111-(TX)	T	36.5/88.4
D2155	1790001250	S.DIO MA2S111-(TX)	T	36.5/89.7
D2156	1790001250	S.DIO MA2S111-(TX)	T	39.0/34.9
D2157	1790001250	S.DIO MA2S111-(TX) except [FRA]	T	48.5/87.1
D2158	1790001250	S.DIO MA2S111-(TX)	T	48.5/88.4
D2159	1790001250	S.DIO MA2S111-(TX)	T	48.5/89.7
D2160	1790001250	S.DIO MA2S111-(TX)	T	48.5/91
D2162	1790001250	S.DIO MA2S111-(TX) [USA] only	T	46/88.4
D2163	1790001250	S.DIO MA2S111-(TX) [EUR], [FRA], [ESP], [UK] only	T	46/89.7
D2166	1790001250	S.DIO MA2S111-(TX) [ESP] only	T	29.4/88.2
D2168	1790001250	S.DIO MA2S111-(TX) [EUR], [ESP], [UK] only	T	29.4/90.6
D2169	1790001250	S.DIO MA2S111-(TX) [EUR], [ESP], [USA], [EXP] only	T	26.9/87.1
D2170	1790001250	S.DIO MA2S111-(TX) [EUR], [USA], [EXP] only	T	26.9/88.4
D2171	1790001250	S.DIO MA2S111-(TX) [FRA], [ESP], [EXP] only	T	26.9/89.7
D2172	1790001250	S.DIO MA2S111-(TX)	T	26.9/91
D2173	1790001250	S.DIO MA2S111-(TX)	T	6.4/120.2
D2174	1790001250	S.DIO MA2S111-(TX)	T	52/88.2
D2175	1790001250	S.DIO MA2S111-(TX)	T	52/87
D2176	1790001250	S.DIO MA2S111-(TX)	T	54.5/88.2
D2177	1790001250	S.DIO MA2S111-(TX)	T	54.5/87
D2201	1730002340	S.ZEN MA8047-M (TX)	T	10.5/123
D2205	1790001010	S.ZEN MA8043-L (TX)	T	13.5/115.2
D2211	1790001010	S.ZEN MA8043-L (TX)	T	21.5/118
D2231	1160000070	S.DIO DAN202K T146	T	57.6/117.8
D2232	1790001670	S.DIO RB706F-40T106	T	56.8/112.2
D2401	1160000070	S.DIO DAN202K T146	B	85.7/27.2
D2402	1790001250	S.DIO MA2S111-(TX)	T	63.5/113.2
D2551	1790001140	S.ZEN MA8039-L (TX)	B	45.3/116.8
D2601	1160000070	S.DIO DAN202K T146	B	42/126.3
D2602	1790001250	S.DIO MA2S111-(TX)	B	41.2/128.5
FI2	2040001420	S.LC LFB32440MSC1-955	T	59.4/13.9
FI3	2040001420	S.LC LFB32440MSC1-955	T	53.3/13.4
FI601	2010002640	S.XTL FL-374 (124.487 MHz)	T	81/43.7
FI901	2020002010	S.CER CFUCG455KF4A-R0	T	44.7/69.7
FI1001	2020002010	S.CER CFUCG455KF4A-R0	T	27.8/66.9
FI1401	2020001810	S.CER SFECV10M7FA00-R0	B	37.5/76.4
FI1402	2020001810	S.CER SFECV10M7FA00-R0	B	29.5/77.5
FI1501	2040001560	SAW WFSTSB6321D [Others]	T	
	2040001570	SAW WFSTSB6221D [USA]	T	
FI1502	2020001700	S.CER SFSKA4M50CF00-R1 [USA]	B	69.3/57.8
	2020001720	S.CER SFSKA5M50CF00-R1 [Others]	B	69.3/57.8
FI1503	2020001710	S.CER TPSKA4M50B00-R1 [USA]	B	73.5/78.7
	2020001730	S.CER TPSKA5M50B00-R1 [Others]	B	73.5/78.7

M.=Mounted side (T: Mounted on the Top side, B: Mounted on the Bottom side)
S.=Surface mount

[MAIN UNIT]

REF NO.	ORDER NO.	DESCRIPTION	M.	H/V LOCATION
L3	6200004480	S.COL MLF1608D R82K-T	T	76.4/10.1
L4	6200002041	S.COL NLV25T-101J	T	76.1/19
L5	6200004780	S.COL MLF1608A 1R5K-T	T	67.2/18.6
L8	6200011320	S.COL ELJQE 56NJ	T	57/16.6
L10	6200011320	S.COL ELJQE 56NJ	T	57.3/17.9
L11	6200011380	S.COL ELJNJ R18J	T	56.5/20
L12	6200011400	S.COL ELJNJ R12J	T	53.8/19.8
L13	6200011380	S.COL ELJNJ R18J	T	52.8/18.5
L14	6200011350	S.COL ELJQE 18NJ	T	57.5/11.5
L16	6200011320	S.COL ELJQE 56NJ	T	49.6/19.8
L18	6200005041	S.COL NLV25T-220J	T	73.4/9.8
L19	6200002041	S.COL NLV25T-101J	T	66.6/14.8
L21	6200006671	S.COL ELJRE 68NGFA	B	80.4/14
L22	6200002861	S.COL NLV25T-4R7J	B	80.5/19.6
L23	6200002861	S.COL NLV25T-4R7J	B	84.9/2
L24	6200011520	S.COL SLF7045T-102MR14-PF	B	8.8/69
L101	6200002041	S.COL NLV25T-101J	T	15.7/17
L102	6200002041	S.COL NLV25T-101J	T	20.4/10.8
L103	6200010800	S.COL C2520C-4R7G-A	T	23.7/7.8
L104	6200010800	S.COL C2520C-4R7G-A	T	27.9/9.9
L105	6200002041	S.COL NLV25T-101J	T	28.1/12.8
L106	6200002041	S.COL NLV25T-101J	B	17.5/16.3
L107	6200002041	S.COL NLV25T-101J	B	31.6/21.6
L108	6200002041	S.COL NLV25T-101J	T	25.2/20.8
L109	6200001831	S.COL NLV32T-100J	T	28.5/15.5
L110	6200003121	S.COL NLV32T-8R2J	T	21.1/15.1
L112	6200002041	S.COL NLV25T-101J	B	43.5/23
L113	6200002041	S.COL NLV25T-101J	T	7.2/17.6
L114	6200002041	S.COL NLV25T-101J	T	7.2/15
L116	6200003131	S.COL NLV32T-120J	T	28.5/18.6
L117	6200001831	S.COL NLV32T-100J	T	21.1/18.1
L204	6200002041	S.COL NLV25T-101J	T	18.7/32.9
L205	6200010740	S.COL C2520C-R27G-A	T	20.2/38.1
L207	6200010680	S.COL C2520C-R22G-A	T	21.8/41.3
L213	6200005011	S.COL NLV25T-100J	T	22.7/34.9
L215	6200010330	S.COL C2012C-R18G-A	B	27.7/38.6
L217	6200009990	S.COL C2012C-R22G-A	T	22.7/32.5
L218	6200005011	S.COL NLV25T-100J	B	25.6/43.3
L219	6200011050	S.COL C2012C-R12G-A	B	29/41.4
L220	6200010320	S.COL C2012C-R15G-A	B	34.1/37.9
L221	6200002041	S.COL NLV25T-101J	T	15.1/52.6
L222	6200002041	S.COL NLV25T-101J	T	45.6/61.4
L223	6200002041	S.COL NLV25T-101J	B	40.4/55.3
L224	6200002041	S.COL NLV25T-101J	B	27.5/55.7
L225	6200002041	S.COL NLV25T-101J	B	27.4/52
L226	6200002861	S.COL NLV25T-4R7J	T	40.3/57.6
L227	6200003711	S.COL NLV25T-2R7J	T	29.1/55.5
L228	6200002861	S.COL NLV25T-4R7J	T	44.6/54.7
L229	6200004671	S.COL NLV25T-3R9J	T	35.1/51.5
L230	6200002041	S.COL NLV25T-101J	B	40.4/52.2
L231	6200002041	S.COL NLV25T-101J	B	40.4/49.4
L232	6200002041	S.COL NLV25T-101J	B	27.1/49.1
L233	6200002041	S.COL NLV25T-101J	B	26.4/46.2
L234	6200010780	S.COL C2520C-1ROG-A	T	35.5/48.5
L235	6200010530	S.COL C2520C-R56G-A	B	32.9/49.5
L236	6200010950	S.COL C2520C-1R5G-A	T	43.4/50.4
L237	6200010450	S.COL C2520C-R82G-A	B	32.9/46.3
L238	6200002041	S.COL NLV25T-101J	B	43.9/45
L239	6200002041	S.COL NLV25T-101J	B	38.8/39.5
L240	6200002041	S.COL NLV25T-101J	T	29.5/42.1
L241	6200010870	S.COL C2520C-R33G-A	B	35.1/41.6
L242	6200005011	S.COL NLV25T-100J	T	33.5/29.9
L243	6140004601	S.COL LR-518A	T	28.4/35.2
L244	6200010960	S.COL C2520C-R47G-A	B	39.7/44.1
L245	6200005011	S.COL NLV25T-100J	B	41.2/28.3
L246	6200009990	S.COL C2012C-R22G-A	B	30.7/36.4
L247	6200010320	S.COL C2012C-R15G-A	B	42.1/38.7
L248	6200005011	S.COL NLV25T-100J	B	43.8/36.3
L301	6200002041	S.COL NLV25T-101J	T	36.1/27.4
L302	6200002041	S.COL NLV25T-101J	T	52.6/31.8
L303	6200002041	S.COL NLV25T-101J	T	52.3/35.4
L304	6140004591	S.COL LR-517A	T	56.4/39
L305	6200002041	S.COL NLV25T-101J	T	52.8/29.3
L306	6200002041	S.COL NLV25T-101J	T	61.7/39.3
L307	6200002041	S.COL NLV25T-101J	T	60.9/32
L308	6200002041	S.COL NLV25T-101J	T	64.9/33.1
L309	6200011350	S.COL ELJQE 18NJ	T	49.3/24
L310	6200010650	S.COL C2520C-R12G-A	T	65.7/38.2
L311	6200011360	S.COL ELJQE 15NJ	T	53.5/23.2
L312	6200010660	S.COL C2520C-R15G-A	T	69.6/34.3
L313	6200011570	S.COL ELJQE 10NJ	T	61.5/25.7
L314	6200002041	S.COL NLV25T-101J	T	72.5/37.3
L315	6200002041	S.COL NLV25T-101J	T	75.8/32
L402	6140004610	S.COL LR-520	T	70.8/27.9
L403	6200002041	S.COL NLV25T-101J	T	81.1/19.7
L404	6130002961	S.COL #617DB-1327=P3	T	84.4/27.9
L406	6130002961	S.COL #617DB-1327=P3	T	77.5/24.2
L421	6200004590	S.COL MLF1608D R18K-T	T	86.4/21.7
L501	6200004660	S.COL MLF1608A 1R8K-T	T	93.4/35.7
L503	6200004660	S.COL MLF1608A 1R8K-T	T	83.2/31.1
L507	6200001981	S.COL NLV25T-1R0J	T	79.2/33.5

[MAIN UNIT]

REF NO.	ORDER NO.	DESCRIPTION	M.	H/V LOCATION
L508	6200010650	S.COL C2520C-R12G-A	T	86.3/34.4
L509	6200004660	S.COL MLF1608A 1R8K-T	T	91.1/38.7
L511	6200004150	S.COL MLF1608D 47NM-T	T	92.7/37.2
L512	6200011700	S.COL ELJQE 39NJ	B	89.6/32.8
L601	6200004660	S.COL MLF1608A 1R8K-T	B	85.7/38.6
L603	6200004660	S.COL MLF1608A 1R8K-T	T	89.3/42.2
L604	6150005330	S.COL LS-548	T	90.5/46.2
L605	6200004660	S.COL MLF1608A 1R8K-T	T	93.1/39.9
L607	6200011800	S.COL C2520C-47NG-A	B	85.6/43.5
L609	6200011800	S.COL C2520C-47NG-A	B	81.5/46
L610	6200004660	S.COL MLF1608A 1R8K-T	B	78.1/44.8
L611	6200004660	S.COL MLF1608A 1R8K-T	T	68/46.3
L612	6150005330	S.COL LS-548	T	72.2/42.4
L701	6150005350	S.COL LS-550	T	62.9/48.6
L702	6150005340	S.COL LS-549	T	54.8/45.4
L703	6150005350	S.COL LS-550	T	55.3/59.5
L704	6200004940	S.COL MLF1608D R27K-T	T	62.3/59.6
L705	6200009920	S.COL C2012C-R10G-A	T	61.8/41.7
L801	6140002810	S.COL LR-317	T	68.6/61.3
L802	6200005190	S.COL MLF1608D R56K-T	T	89/58.4
L803	6140002810	S.COL LR-317	T	79.6/60.1
L804	6200005011	S.COL NLV25T-100J	T	57.5/69.1
L805	6200009871	S.COL NLV25T-120J	T	57.6/71.9
L806	6200004741	S.COL NLV25T-1R2J	T	63.1/71.2
L807	6200004741	S.COL NLV25T-1R2J	T	63.2/66.7
L808	6200004100	S.COL MLF1608D 68NM-T	T	86.1/61.6
L901	6200003520	S.COL ELJFB 102K-F	B	37.6/72.4
L904	6150005360	S.COL LS-551	T	51.6/70.9
L905	6200003520	S.COL ELJFB 102K-F	B	40.2/59.9
L906	6200003520	S.COL ELJFB 102K-F	B	33.6/62.4
L908	6200003520	S.COL ELJFB 102K-F	B	31.5/69.7
L1003	6200003520	S.COL ELJFB 102K-F	B	12.9/75.3
L1102	6200002041	S.COL NLV25T-101J	T	7.1/89.7
L1301	6200002041	S.COL NLV25T-101J	T	8.3/55.8
L1302	6200002041	S.COL NLV25T-101J	T	11.8/58.5
L1303	6200002041	S.COL NLV25T-101J	T	4.8/55.8
L1401	6200002041	S.COL NLV25T-101J	B	43.3/79.6
L1402	6200004790	S.COL MLF1608D R47K-T	B	44.1/70.4
L1403	6200002041	S.COL NLV25T-101J	B	43/77.1
L1404	6200003711	S.COL NLV25T-2R7J	B	18.2/80.4
L1405	6200002041	S.COL NLV25T-101J	B	17.7/85
L1491	6200010740	S.COL C2520C-R27G-A	[USA] B	84.9/30.7
	6200010870	S.COL C2520C-R33G-A	[Others] B	84.9/30.7
L1492	6200010650	S.COL C2520C-R12G-A	[Others] B	80.6/33.1
	6200010740	S.COL C2520C-R27G-A	[USA] B	80.6/33.1
L1492	6200010870	S.COL C2520C-R33G-A	[Others] B	80.6/33.1
L1501	6200005011	S.COL NLV25T-100J	B	91.1/27.1
L1502	6200011380	S.COL ELJNJ R18J	B	79.4/38.2
L1503	6200011380	S.COL ELJNJ R18J	B	82/37.5
L1504	6200005011	S.COL NLV25T-100J	B	75.6/43.4
L1505	6200005190	S.COL MLF1608D R56K-T	B	73.2/48.5
L1506	6150005070	S.COL LS-534 (4KMH)	[USA] T	68.7/55.4
	6150005080	S.COL LS-535 (4KMH)	[Others] T	68.7/55.4
L1507	6200005031	S.COL NLV25T-180J	B	71.7/62.2
L1508	6200005021	S.COL NLV25T-150J	B	77.3/79.5
L1951	6180003610	S.COL 7E10L-101M 100U	B	34.6/110.9
L1952	6180003610	S.COL 7E10L-101M 100U	B	54.7/113.3
L1953	6180003610	S.COL 7E10L-101M 100U	B	14/111.9
L1954	6180003610	S.COL 7E10L-101M 100U	B	24.4/119.8
L2001	6200005011	S.COL NLV25T-100J	B	72.5/16.4
L2002	6200002041	S.COL NLV25T-101J	B	84.5/3.8
L2003	6200002041	S.COL NLV25T-101J	B	81.1/4.3
L2004	6200002041	S.COL NLV25T-101J	B	76.3/20.4
L2006	6200002041	S.COL NLV25T-101J	B	64.2/12.8
L2007	6200002041	S.COL NLV25T-101J	B	70.9/3.8
L2008	6200002041	S.COL NLV25T-101J	B	67.9/6.1
L2009	6200005011	S.COL NLV25T-100J	B	70.8/10.6
L2010	6200002041	S.COL NLV25T-101J	B	60.7/13.7
L2011	6200011300	S.COL EXCML16A 270U	T	86.6/9.1
L2012	6200011300	S.COL EXCML16A 270U	B	84.7/21.9
L2013	6200002041	S.COL NLV25T-101J	B	71.8/19.6
L2015	6200002041	S.COL NLV25T-101J	B	52.5/10.4
L2016	6200002041	S.COL NLV25T-101J	B	59.2/11.2
L2017	6200002041	S.COL NLV25T-101J	B	57/14
L2018	6200002041	S.COL NLV25T-101J	B	19.7/129.4
L2019	6200002041	S.COL NLV25T-101J	T	22.2/126.9
L2020	6200002041	S.COL NLV25T-101J	B	27.9/131.3
L2021	6200005011	S.COL NLV25T-100J	B	27.9/126.5
L2022	6200002041	S.COL NLV25T-101J	B	22.9/127.8
L2023	6200002041	S.COL NLV25T-101J	B	23.2/131.2
L2024	6200002041	S.COL NLV25T-101J	T	12.7/128.2
L2025	6200002041	S.COL NLV25T-101J	B	87.5/6.2
L2026	6200002041	S.COL NLV25T-101J	B	77.6/5
L2027	6200002041	S.COL NLV25T-101J	B	76.5/12.2
L2028	6200002041	S.COL NLV25T-101J	B	67.4/10.8
L2029	6200002041	S.COL NLV25T-101J	B	64/10.3
L2030	6200002041	S.COL NLV25T-101J	B	67.5/3.6
L2031	6200002041	S.COL NLV25T-101J	B	76.5/14.7
L2032	6200002041	S.COL NLV25T-101J	B	66.2/15.3
L2033	6200011300	S.COL EXCML16A270U	B	69.6/14.5
L2034	6200009300	S.COL ELJPA 100KF 10U	B	67.8/19.6

M.=Mounted side (T: Mounted on the Top side, B: Mounted on the Bottom side)
S.=Surface mount

[MAIN UNIT]

REF NO.	ORDER NO.	DESCRIPTION	M.	H/V LOCATION
L2035	6200002041	S.COL NLV25T-101J	B	59.8/18.4
L2036	6200002041	S.COL NLV25T-101J	B	64.1/3.8
L2037	6200002041	S.COL NLV25T-101J	B	88.3/3.7
L2041	6180003610	S.COL 7E10L-101M 100U	B	62.6/86.9
L2042	6200002861	S.COL NLV25T-4R7J	B	62.9/79.3
L2053	6200002041	S.COL NLV25T-101J	B	28.7/90.9
L2151	6200002041	S.COL NLV25T-101J	B	36.9/121
L2152	6200002041	S.COL NLV25T-101J	B	52.3/14.7
L2201	6200005011	S.COL NLV25T-100J	T	27.2/126
L2202	6200005011	S.COL NLV25T-100J	T	16.5/124.3
L2231	6200002041	S.COL NLV25T-101J	T	34/104.2
L2256	6200002041	S.COL NLV25T-101J	T	15/103.4
L2257	6200002041	S.COL NLV25T-101J	T	10.5/89.7
L2260	6200002041	S.COL NLV25T-101J	T	68.5/110.9
L2263	6200002041	S.COL NLV25T-101J	T	62.3/99.4
L2264	6200002041	S.COL NLV25T-101J	T	62.3/96.9
L2265	6200002041	S.COL NLV25T-101J	T	62.4/94.3
L2266	6200002041	S.COL NLV25T-101J	T	62.4/91.5
L2267	6200002041	S.COL NLV25T-101J	T	66/89.6
L2268	6200002041	S.COL NLV25T-101J	T	62.4/87.1
L2272	6200002041	S.COL NLV25T-101J	T	71.1/90.2
L2402	6200002041	S.COL NLV25T-101J	B	89.4/98
L2403	6200002041	S.COL NLV25T-101J	B	89.2/84
L2404	6200002041	S.COL NLV25T-101J	T	81.6/96.8
L2405	6200002041	S.COL NLV25T-101J	B	89.3/95.5
L2406	6200002041	S.COL NLV25T-101J	T	84.8/93.7
L2408	6200011300	S.COL EXCML16A 270U	T	82.1/92.3
L2409	6200002041	S.COL NLV25T-101J	T	89.3/88.5
L2411	6200011300	S.COL EXCML16A 270U	T	85.1/89.7
L2601	6200009330	S.COL SLF12555T-681MR43	T	87.5/119.6
L2605	6200009330	S.COL SLF12555T-681MR43	T	71/119.6
R1	7030011400	S.RES ERJ2GE 5R6 X (5.6 Ω)	T	80.1/17
R2	7030009270	S.RES ERJ2GEJ 821 X (820 Ω)	T	80.1/17.9
R3	7030009270	S.RES ERJ2GEJ 821 X (820 Ω)	T	80.1/16.1
R5	7030011400	S.RES ERJ2GE 5R6 X (5.6 Ω)	T	74.1/17.4
R6	7030009270	S.RES ERJ2GEJ 821 X (820 Ω)	T	75.2/16.4
R7	7030009270	S.RES ERJ2GEJ 821 X (820 Ω)	T	73.4/16.4
R8	7030009200	S.RES ERJ2GEJ 390 X (39 Ω)	T	72.7/19.2
R9	7030003400	S.RES ERJ3GGEVJ 471 V (470 Ω)	T	69.9/13.3
R10	7030005120	S.RES ERJ2GEJ 102 X (1 kΩ)	T	72.5/17.4
R11	7030005300	S.RES ERJ2GEJ 150 X (15 Ω)	T	62.1/15.9
R12	7030010040	S.RES ERJ2GEJ-JPW	T	63.7/13.8
R13	7030005090	S.RES ERJ2GEJ 104 X (100 kΩ)	T	66.6/20.6
R15	7030005090	S.RES ERJ2GEJ 104 X (100 kΩ)	T	68.8/10.6
R16	7030003860	S.RES ERJ3GE JPW V	T	62.4/12.3
R17	7030005090	S.RES ERJ2GEJ 104 X (100 kΩ)	T	76.8/15.8
R18	7030007270	S.RES ERJ2GEJ 151 X (150 Ω)	T	44.2/17.2
R19	7030003860	S.RES ERJ3GE JPW V	T	50.4/14.6
R20	7030009530	S.RES ERJ2GEJ 270 X (27 Ω)	T	69.5/19.7
R21	7030009530	S.RES ERJ2GEJ 270 X (27 Ω)	T	66.1/22.8
R22	7030010040	S.RES ERJ2GEJ-JPW	T	78.1/13.8
R23	7030007290	S.RES ERJ2GEJ 222 X (2.2 kΩ)	T	79.8/13.8
R24	7030005010	S.RES ERJ2GEJ 681 X (680 Ω)	T	78.1/12.9
R25	7030005120	S.RES ERJ2GEJ 102 X (1 kΩ)	B	79.6/17.8
R27	7030005120	S.RES ERJ2GEJ 102 X (1 kΩ)	B	81.3/8.5
R29	7030004980	S.RES ERJ2GEJ 101 X (100 Ω)	T	73.1/12.3
R30	7030009160	S.RES ERJ2GEJ 181 X (180 Ω)	T	46.4/15.4
R31	7030007270	S.RES ERJ2GEJ 151 X (150 Ω)	T	42.6/17.2
R32	7030009200	S.RES ERJ2GEJ 390 X (39 Ω)	T	44.1/18.2
R33	7030010040	S.RES ERJ2GEJ-JPW	T	60/18
R34	7030010040	S.RES ERJ2GEJ-JPW	T	62/18
R35	7030003860	S.RES ERJ3GE JPW V	T	64/18
R101	7030005050	S.RES ERJ2GEJ 103 X (10 kΩ)	T	13.2/16
R102	7030005120	S.RES ERJ2GEJ 102 X (1 kΩ)	T	11.9/14.6
R103	7030005050	S.RES ERJ2GEJ 103 X (10 kΩ)	T	10.3/14.6
R104	7030005090	S.RES ERJ2GEJ 104 X (100 kΩ)	T	15.7/13.4
R105	7030005580	S.RES ERJ2GEJ 560 X (56 Ω)	T	15.7/22.3
R106	7030005000	S.RES ERJ2GEJ 471 X (470 Ω)	T	13.2/20.5
R107	7030005000	S.RES ERJ2GEJ 471 X (470 Ω)	T	10.8/22.1
R108	7030005000	S.RES ERJ2GEJ 471 X (470 Ω)	T	10.8/23
R111	7030005000	S.RES ERJ2GEJ 471 X (470 Ω)	T	10.8/21.2
R112	7030005090	S.RES ERJ2GEJ 104 X (100 kΩ)	T	25.6/12.5
R113	7030005090	S.RES ERJ2GEJ 104 X (100 kΩ)	T	26.7/5.7
R114	7030009280	S.RES ERJ2GEJ 391 X (390 Ω)	B	33.1/23.4
R115	7030009280	S.RES ERJ2GEJ 391 X (390 Ω)	B	34.1/22.2
R116	7030009280	S.RES ERJ2GEJ 391 X (390 Ω)	T	22.3/21.3
R117	7030009280	S.RES ERJ2GEJ 391 X (390 Ω)	T	20.7/21.3
R118	7030009280	S.RES ERJ2GEJ 391 X (390 Ω)	B	40.9/23.2
R119	7030009280	S.RES ERJ2GEJ 391 X (390 Ω)	B	40.9/22.3
R120	7030005090	S.RES ERJ2GEJ 104 X (100 kΩ)	B	50.3/23.5
R121	7030005090	S.RES ERJ2GEJ 104 X (100 kΩ)	T	44/22.2
R122	7030009280	S.RES ERJ2GEJ 391 X (390 Ω)	T	7.8/20.3
R123	7030009280	S.RES ERJ2GEJ 391 X (390 Ω)	T	7.8/19.4
R125	7030009280	S.RES ERJ2GEJ 391 X (390 Ω)	T	35.5/20.2
R126	7030009280	S.RES ERJ2GEJ 391 X (390 Ω)	T	26.7/4.8
R127	7030009280	S.RES ERJ2GEJ 391 X (390 Ω)	T	25/4.8
R128	7030009280	S.RES ERJ2GEJ 391 X (390 Ω)	T	35.5/19.3
R202	7030005090	S.RES ERJ2GEJ 104 X (100 kΩ)	T	18.1/31.2
R203	7030005090	S.RES ERJ2GEJ 104 X (100 kΩ)	T	42.9/59.9

[MAIN UNIT]

REF NO.	ORDER NO.	DESCRIPTION	M.	H/V LOCATION
R204	7030005090	S.RES ERJ2GEJ 104 X (100 kΩ)	B	42.9/54.3
R205	7030009280	S.RES ERJ2GEJ 391 X (390 Ω)	T	19.4/54.2
R206	7030005090	S.RES ERJ2GEJ 104 X (100 kΩ)	B	42.9/51.4
R207	7030005090	S.RES ERJ2GEJ 104 X (100 kΩ)	B	42.9/50.5
R208	7030005090	S.RES ERJ2GEJ 104 X (100 kΩ)	B	46.4/45
R216	7030005090	S.RES ERJ2GEJ 104 X (100 kΩ)	B	44.2/43.3
R217	7030005050	S.RES ERJ2GEJ 103 X (10 kΩ)	T	18.1/30.3
R218	7030004970	S.RES ERJ2GEJ 470 X (47 Ω)	T	21.9/29.9
R225	7030005050	S.RES ERJ2GEJ 103 X (10 kΩ)	T	19.1/29.1
R226	7030009280	S.RES ERJ2GEJ 391 X (390 Ω)	T	17.6/54.2
R227	7030005120	S.RES ERJ2GEJ 102 X (1 kΩ)	T	30.9/30.9
R228	7030009140	S.RES ERJ2GEJ 272 X (2.7 kΩ)	T	30.9/29.1
R301	7030009280	S.RES ERJ2GEJ 391 X (390 Ω)	T	44.5/28.8
R302	7030009280	S.RES ERJ2GEJ 391 X (390 Ω)	T	38.6/27.8
R303	7030004970	S.RES ERJ2GEJ 470 X (47 Ω)	T	52.5/38.9
R304	7030004980	S.RES ERJ2GEJ 101 X (100 Ω)	T	55.1/35.6
R305	7030005120	S.RES ERJ2GEJ 102 X (1 kΩ)	T	59.9/33.8
R306	7030008280	S.RES ERJ2GEJ 271 X (270 Ω)	T	55.3/28.7
R307	7030004980	S.RES ERJ2GEJ 101 X (100 Ω)	T	56.7/35.6
R308	7030007290	S.RES ERJ2GEJ 222 X (2.2 kΩ)	T	59.2/30.1
R309	7030008280	S.RES ERJ2GEJ 271 X (270 Ω)	T	58.5/29.1
R310	7030005090	S.RES ERJ2GEJ 104 X (100 kΩ)	T	50.1/31.7
R311	7030009280	S.RES ERJ2GEJ 391 X (390 Ω)	T	65.3/31.3
R312	7030009280	S.RES ERJ2GEJ 391 X (390 Ω)	T	63.7/31.3
R314	7030009280	S.RES ERJ2GEJ 391 X (390 Ω)	T	73.3/32.5
R315	7030009280	S.RES ERJ2GEJ 391 X (390 Ω)	T	74.8/33.8
R401	7030010040	S.RES ERJ2GEJ-JPW	T	75/29.7
R402	7030010040	S.RES ERJ2GEJ-JPW	T	75/27
R403	7030004980	S.RES ERJ2GEJ 101 X (100 Ω)	T	76.7/29.7
R404	7030010040	S.RES ERJ2GEJ-JPW	T	73.1/23.5
R405	7030010040	S.RES ERJ2GEJ-JPW	T	85/24.1
R406	7030004970	S.RES ERJ2GEJ 470 X (47 Ω)	T	73.1/30.6
R407	7030004970	S.RES ERJ2GEJ 470 X (47 Ω)	T	73.1/25.3
R411	7030007260	S.RES ERJ2GEJ 330 X (33 Ω)	T	80/29.5
R412	7030007260	S.RES ERJ2GEJ 330 X (33 Ω)	T	80/26.8
R414	7030004980	S.RES ERJ2GEJ 101 X (100 Ω)	T	78.3/29.6
R416	7030010090	S.RES ERJ2GEJ 180 X (18 Ω)	T	87.8/24
R417	7030008280	S.RES ERJ2GEJ 271 X (270 Ω)	T	87.8/24.9
R418	7030008280	S.RES ERJ2GEJ 271 X (270 Ω)	T	87.8/22.9
R421	7030010090	S.RES ERJ2GEJ 180 X (18 Ω)	B	88.5/20.2
R422	7030008280	S.RES ERJ2GEJ 271 X (270 Ω)	B	90.1/20.2
R423	7030008280	S.RES ERJ2GEJ 271 X (270 Ω)	B	90.1/19.3
R424	7030005530	S.RES ERJ2GEJ 100 X (10 Ω)	T	88.5/21.6
R501	7030005120	S.RES ERJ2GEJ 102 X (1 kΩ)	T	91.3/35.6
R502	7030005120	S.RES ERJ2GEJ 102 X (1 kΩ)	T	92.9/33.8
R509	7030005580	S.RES ERJ2GEJ 560 X (56 Ω)	T	83.4/33.1
R510	7030007250	S.RES ERJ2GEJ 220 X (22 Ω)	T	83.4/34.1
R512	7030004980	S.RES ERJ2GEJ 101 X (100 Ω)	T	81.7/34.1
R517	7030010040	S.RES ERJ2GEJ-JPW	B	80/31
R518	7030007290	S.RES ERJ2GEJ 222 X (2.2 kΩ)	T	79.3/37
R519	7030007290	S.RES ERJ2GEJ 222 X (2.2 kΩ)	T	79.3/38.8
R520	7030005120	S.RES ERJ2GEJ 102 X (1 kΩ)	T	89.1/39.2
R521	7030005000	S.RES ERJ2GEJ 471 X (470 Ω)	T	84.2/40.4
R523	7030005120	S.RES ERJ2GEJ 102 X (1 kΩ)	T	91.3/34.7
R524	7030005120	S.RES ERJ2GEJ 102 X (1 kΩ)	B	86.9/37
R601	7030005000	S.RES ERJ2GEJ 471 X (470 Ω)	B	88.5/40
R602	7030005000	S.RES ERJ2GEJ 471 X (470 Ω)	T	91/39.6
R603	7030005000	S.RES ERJ2GEJ 471 X (470 Ω)	T	89.1/41
R604	7030005000	S.RES ERJ2GEJ 471 X (470 Ω)	B	78.6/45.9
R605	7030010040	S.RES ERJ2GEJ-JPW	T	68.2/45.2
R606	7030005090	S.RES ERJ2GEJ 104 X (100 kΩ)	T	67.1/47.4
R607	7030005120	S.RES ERJ2GEJ 102 X (1 kΩ)	T	66.6/45.2
R701	7030005120	S.RES ERJ2GEJ 223 X (22 kΩ)	T	61.1/53
R702	7030005120	S.RES ERJ2GEJ 102 X (1 kΩ)	T	64.2/43.9
R703	7030004970	S.RES ERJ2GEJ 470 X (47 Ω)	T	50.8/44.1
R705	7030004990	S.RES ERJ2GEJ 221 X (220 Ω)	T	59/51.5
R706	7030009270	S.RES ERJ2GEJ 821 X (820 Ω)	T	64.5/55.9
R707	7030004980	S.RES ERJ2GEJ 101 X (100 Ω)	T	59.5/57
R708	7030007290	S.RES ERJ2GEJ 222 X (2.2 kΩ)	T	63.9/58.6
R709	7030005210	S.RES ERJ2GEJ 822 X (8.2 kΩ)	T	59.5/55.1
R710	7030005120	S.RES ERJ2GEJ 102 X (1 kΩ)	T	59.8/62.5
R711	7030009140	S.RES ERJ2GEJ 272 X (2.7 kΩ)	T	50.5/51.4
R712	7030005120	S.RES ERJ2GEJ 102 X (1 kΩ)	T	51.2/50.5
R713	7030005050	S.RES ERJ2GEJ 103 X (10 kΩ)	T	57.1/51.5
R715	7030004970	S.RES ERJ2GEJ 470 X (47 Ω)	T	52.1/54.1
R716	7030005710	S.RES ERJ2GEJ 121 X (120 Ω)	T	51.3/57.5
R717	7030007300	S.RES ERJ2GEJ 332 X (3.3 kΩ)	T	52.1/51.4
R718	7510001461	S.TMR NTCG16 3NH 471JT	T	63.3/54
R801	7030008280	S.RES ERJ2GEJ 271 X (270 Ω)	T	86.8/55.1
R802	7030005120	S.RES ERJ2GEJ 102 X (1 kΩ)	T	65.3/60.9
R803	7030005120	S.RES ERJ2GEJ 102 X (1 kΩ)	T	71.9/64.9
R804	7030005530	S.RES ERJ2GEJ 100 X (10 Ω)	T	91.1/57.1
R805	7030010090	S.RES ERJ2GEJ 180 X (18 Ω)	T	86.3/44.1
R806	7030008280	S.RES ERJ2GEJ 271 X (270 Ω)	T	85.2/55.1
R807	7030005120	S.RES ERJ2GEJ 102 X (1 kΩ)	T	62.8/64.6
R808	7030004970	S.RES ERJ2GEJ 470 X (47 Ω)	T	62.3/69.4
R809	7030008280	S.RES ERJ2GEJ 271 X (270 Ω)	T	82.8/60.6
R810	7030010090	S.RES ERJ2GEJ 180 X (18 Ω)	T	84.4/60.6
R811	7030008280	S.RES ERJ2GEJ 271 X (270 Ω)	T	82.8/59.7
R904	7030003860	S.RES ERJ3GE JPW V	T	36.5/68.1
R905	7030004980	S.RES ERJ2GEJ 101 X (100 Ω)	T	39.2/64.6

M.=Mounted side (T: Mounted on the Top side, B: Mounted on the Bottom side)
S.=Surface mount

[MAIN UNIT]

REF NO.	ORDER NO.	DESCRIPTION	M.	H/V LOCATION
R906	7030007290	S.RES ERJ2GEJ 222 X (2.2 kΩ)	T	39.2/66.5
R907	7030004990	S.RES ERJ2GEJ 221 X (220 Ω)	T	36.8/70
R908	7030005000	S.RES ERJ2GEJ 471 X (470 Ω)	T	35.6/61.9
R909	7030008410	S.RES ERJ2GEJ 392 X (3.9 kΩ)	T	34.2/68.4
R912	7030005210	S.RES ERJ2GEJ 822 X (8.2 kΩ)	T	34.2/66.6
R913	7030007300	S.RES ERJ2GEJ 332 X (3.3 kΩ)	T	40.5/75
R914	7030009290	S.RES ERJ2GEJ 562 X (5.6 kΩ)	T	36.5/75.4
R915	7030007290	S.RES ERJ2GEJ 222 X (2.2 kΩ)	T	36.6/70.9
R916	7030005050	S.RES ERJ2GEJ 103 X (10 kΩ)	T	37.2/75.4
R917	7030004970	S.RES ERJ2GEJ 470 X (47 Ω)	T	34.2/69.3
R918	7030007290	S.RES ERJ2GEJ 222 X (2.2 kΩ)	B	31.4/72.1
R919	7030004980	S.RES ERJ2GEJ 101 X (100 Ω)	T	31.5/72.1
R1009	7030009290	S.RES ERJ2GEJ 562 X (5.6 kΩ)	T	25.8/72.9
R1018	7030007290	S.RES ERJ2GEJ 222 X (2.2 kΩ)	T	18.1/73.7
R1019	7030005050	S.RES ERJ2GEJ 103 X (10 kΩ)	T	20.3/76.9
R1020	7030005000	S.RES ERJ2GEJ 471 X (470 Ω)	T	12.7/77.6
R1022	7510001461	S.TMR NTCG16 3NH 471JT	T	14.8/75.9
R1023	7030008370	S.RES ERJ2GEJ 561 X (560 Ω)	T	15.2/74.7
R1024	7030004980	S.RES ERJ2GEJ 101 X (100 Ω)	T	12.7/74.9
R1025	7030007260	S.RES ERJ2GEJ 330 X (33 Ω)	T	12.7/76.7
R1027	7030005120	S.RES ERJ2GEJ 102 X (1 kΩ)	T	4.6/87.8
R1201	7030005000	S.RES ERJ2GEJ 471 X (470 Ω)	T	25.7/77.6
R1202	7030005240	S.RES ERJ2GEJ 473 X (47 kΩ)	T	24/78.5
R1203	7030005240	S.RES ERJ2GEJ 473 X (47 kΩ)	T	25.6/78.5
R1204	7030005240	S.RES ERJ2GEJ 473 X (47 kΩ)	T	20.2/79.2
R1205	7030005000	S.RES ERJ2GEJ 471 X (470 Ω)	T	20.2/78.3
R1206	7030005090	S.RES ERJ2GEJ 104 X (100 kΩ)	T	21.8/79.2
R1207	7030005240	S.RES ERJ2GEJ 473 X (47 kΩ)	T	17.9/83.6
R1208	7030004980	S.RES ERJ2GEJ 101 X (100 Ω)	T	9.4/79.8
R1209	7030004980	S.RES ERJ2GEJ 101 X (100 Ω)	T	16.4/79.9
R1211	7030005120	S.RES ERJ2GEJ 102 X (1 kΩ)	T	12.7/77.9
R1212	7030005120	S.RES ERJ2GEJ 102 X (1 kΩ)	T	12.7/78.5
R1213	7030005120	S.RES ERJ2GEJ 102 X (1 kΩ)	T	11.1/79.4
R1215	7030007350	S.RES ERJ2GEJ 393 X (39 kΩ)	T	8.1/81.3
R1216	7030007290	S.RES ERJ2GEJ 222 X (2.2 kΩ)	T	9.5/83.4
R1217	7030007290	S.RES ERJ2GEJ 222 X (2.2 kΩ)	T	8/82.8
R1218	7030005050	S.RES ERJ2GEJ 103 X (10 kΩ)	T	7.5/78.5
R1219	7030005050	S.RES ERJ2GEJ 103 X (10 kΩ)	T	7.5/79.7
R1301	7030010040	S.RES ERJ2GEJ-JPW	T	16.8/72.9
R1302	7030005120	S.RES ERJ2GEJ 102 X (1 kΩ)	T	15.2/77.2
R1303	7030005120	S.RES ERJ2GEJ 102 X (1 kΩ)	T	12.7/77.4
R1304	7030005120	S.RES ERJ2GEJ 102 X (1 kΩ)	T	14.9/68.3
R1305	7030005120	S.RES ERJ2GEJ 102 X (1 kΩ)	T	16.2/63.8
R1306	7030005120	S.RES ERJ2GEJ 102 X (1 kΩ)	T	10.9/56.8
R1308	7030007300	S.RES ERJ2GEJ 332 X (3.3 kΩ)	T	12.9/67.3
R1309	7030005120	S.RES ERJ2GEJ 102 X (1 kΩ)	T	11.3/66.4
R1310	7510001451	S.TMR NTCG16 4BH 472JT	T	12.2/68.4
R1401	7030005120	S.RES ERJ2GEJ 102 X (1 kΩ)	B	45.3/72.3
R1402	7030008010	S.RES ERJ2GEJ 123 X (12 kΩ)	B	43.6/72.3
R1403	7030007290	S.RES ERJ2GEJ 222 X (2.2 kΩ)	B	44.5/73.4
R1404	7030007280	S.RES ERJ2GEJ 331 X (330 Ω)	B	44.5/75.2
R1405	7030004970	S.RES ERJ2GEJ 470 X (47 Ω)	B	42/71.5
R1406	7030005290	S.RES ERJ2GEJ 682 X (6.8 kΩ)	B	38.7/79.9
R1407	7030005120	S.RES ERJ2GEJ 102 X (1 kΩ)	B	38.7/79
R1408	7030007280	S.RES ERJ2GEJ 331 X (330 Ω)	B	38.7/80.8
R1409	7030004970	S.RES ERJ2GEJ 470 X (47 Ω)	B	34.6/80
R1414	7030007340	S.RES ERJ2GEJ 153 X (15 kΩ)	B	20.2/76.4
R1416	7030008410	S.RES ERJ2GEJ 392 X (3.9 kΩ)	B	19.4/83
R1420	7030004990	S.RES ERJ2GEJ 221 X (220 Ω)	B	25/76.8
R1421	7030007270	S.RES ERJ2GEJ 151 X (150 Ω)	B	23.2/75.9
R1422	7030004990	S.RES ERJ2GEJ 221 X (220 Ω)	B	23.2/76.8
R1501	7030010040	S.RES ERJ2GEJ-JPW	B	72.4/38.2
R1502	7030005100	S.RES ERJ2GEJ 154 X (150 kΩ)	B	86.4/55.3
R1503	7030005100	S.RES ERJ2GEJ 154 X (150 kΩ)	B	85.7/54.1
R1504	7030004970	S.RES ERJ2GEJ 470 X (47 Ω)	B	72.4/40.3
R1505	7030007290	S.RES ERJ2GEJ 222 X (2.2 kΩ)	B	73.6/54.8
R1506	7030007350	S.RES ERJ2GEJ 393 X (39 kΩ)	B	85.7/52.3
R1507	7030007350	S.RES ERJ2GEJ 393 X (39 kΩ)	B	85.7/53.2
R1508	7030005220	S.RES ERJ2GEJ 223 X (22 kΩ)	B	74.2/61.6
R1509	7030006610	S.RES ERJ2GEJ 394 X (390 kΩ)	B	85.9/59
R1510	7030005050	S.RES ERJ2GEJ 103 X (10 kΩ)	B	76.6/61.9
R1511	7030005590	S.RES ERJ2GEJ 680 X (68 Ω)	B	85.8/60.8
R1512	7030005120	S.RES ERJ2GEJ 102 X (1 kΩ)	B	71.5/73.7
R1513	7030007280	S.RES ERJ2GEJ 331 X (330 Ω)	B	73.1/73.7
R1514	7030007290	S.RES ERJ2GEJ 222 X (2.2 kΩ)	B	73.1/52.8
R1515	7030007290	S.RES ERJ2GEJ 222 X (2.2 kΩ)	B	71.8/53.6
R1516	7030004970	S.RES ERJ2GEJ 470 X (47 Ω)	B	82.5/35.3
R1521	7030005090	S.RES ERJ2GEJ 104 X (100 kΩ)	B	86.5/50.3
R1522	7030005240	S.RES ERJ2GEJ 473 X (47 kΩ)	B	86.7/46.8
R1523	7030005120	S.RES ERJ2GEJ 102 X (1 kΩ)	B	77.3/39.5
R1524	7030005120	S.RES ERJ2GEJ 102 X (1 kΩ)	B	81.9/40.3
R1525	7030007300	S.RES ERJ2GEJ 332 X (3.3 kΩ)	B	81.9/42.2
R1526	7030005120	S.RES ERJ2GEJ 102 X (1 kΩ)	B	83.5/40.5
R1602	7030005120	S.RES ERJ2GEJ 102 X (1 kΩ)	T	6.3/54
R1603	7030010040	S.RES ERJ2GEJ-JPW	T	13/49.6
R1604	7030007290	S.RES ERJ2GEJ 222 X (2.2 kΩ)	T	13/50.5
R1605	7030005090	S.RES ERJ2GEJ 104 X (100 kΩ)	T	8.8/46.9
R1606	7030005070	S.RES ERJ2GEJ 683 X (68 kΩ)	T	6.1/46.6
R1607	7030005070	S.RES ERJ2GEJ 683 X (68 kΩ)	T	5.1/42.1
R1608	7030005090	S.RES ERJ2GEJ 104 X (100 kΩ)	T	10.4/47.8

[USA] only

[MAIN UNIT]

REF NO.	ORDER NO.	DESCRIPTION	M.	H/V LOCATION
R1609	7030007320	S.RES ERJ2GEJ 225 X (2.2 MΩ)	T	10.4/46
R1610	7030005060	S.RES ERJ2GEJ 333 X (33 kΩ)	T	4.5/43.5
R1611	7030005230	S.RES ERJ2GEJ 334 X (330 kΩ)	T	8.8/47.8
R1612	7030005060	S.RES ERJ2GEJ 333 X (33 kΩ)	T	3.4/42.3
R1613	7030003860	S.RES ERJ3GE JPW V	T	6.7/48.7
R1614	7030007310	S.RES ERJ2GEJ 155 X (1.5 MΩ)	T	6.1/45.7
R1615	7030005040	S.RES ERJ2GEJ 472 X (4.7 kΩ)	T	4.2/35.4
R1616	7030005090	S.RES ERJ2GEJ 104 X (100 kΩ)	T	6.7/35.4
R1617	7030005720	S.RES ERJ2GEJ 563 X (56 kΩ)	T	3.4/38.2
R1618	7310005020	S.TRI RH03ADC14X (10 kΩ)	T	3.5/46.3
R1619	7030005080	S.RES ERJ2GEJ 823 X (82 kΩ)	T	2.6/43.3
R1620	7030008290	S.RES ERJ2GEJ 183 X (18 kΩ)	T	3.4/37.3
R1621	7030005160	S.RES ERJ2GEJ 105 X (1 MΩ)	T	6.7/37.2
R1622	7030010040	S.RES ERJ2GEJ-JPW	T	5/37.3
R1623	7030005000	S.RES ERJ2GEJ 471 X (470 Ω)	T	12/46.8
R1624	7030007250	S.RES ERJ2GEJ 220 X (22 Ω)	T	14.9/38.3
R1625	7030004990	S.RES ERJ2GEJ 221 X (220 Ω)	T	13.6/32.6
R1626	7030005050	S.RES ERJ2GEJ 103 X (10 kΩ)	T	10.3/34.5
R1627	7030007320	S.RES ERJ2GEJ 225 X (2.2 MΩ)	T	10.3/35.4
R1628	7030005120	S.RES ERJ2GEJ 102 X (1 kΩ)	T	4.9/30.8
R1629	7030005050	S.RES ERJ2GEJ 103 X (10 kΩ)	T	4.9/29.9
R1630	7030004980	S.RES ERJ2GEJ 101 X (100 Ω)	T	8.3/45.7
R1631	7030005090	S.RES ERJ2GEJ 104 X (100 kΩ)	T	9.8/37.2
R1634	7030005040	S.RES ERJ2GEJ 472 X (4.7 kΩ)	T	10.3/33.6
R1636	7030007320	S.RES ERJ2GEJ 225 X (2.2 MΩ)	T	13/31.7
R1637	7030007320	S.RES ERJ2GEJ 225 X (2.2 MΩ)	T	12/45.9
R1638	7030008280	S.RES ERJ2GEJ 271 X (270 Ω)	T	10.9/48.8
R1639	7030005120	S.RES ERJ2GEJ 102 X (1 kΩ)	T	14.6/50.5
R1640	7030005090	S.RES ERJ2GEJ 104 X (100 kΩ)	T	10.9/31.6
R1641	7030007320	S.RES ERJ2GEJ 225 X (2.2 MΩ)	T	13/30.7
R1642	7030005120	S.RES ERJ2GEJ 102 X (1 kΩ)	T	56/24
R1701	7030009320	S.RES ERJ2GEJ 4R7 X (4.7 Ω)	T	48/45.3
R1702	7030007280	S.RES ERJ2GEJ 331 X (330 Ω)	B	52.1/44.7
R1703	7030007280	S.RES ERJ2GEJ 331 X (330 Ω)	B	53.7/43.8
R1704	7030007280	S.RES ERJ2GEJ 331 X (330 Ω)	B	53.7/44.7
R1705	7030009320	S.RES ERJ2GEJ 4R7 X (4.7 Ω)	T	48/46.2
R1706	7030007280	S.RES ERJ2GEJ 331 X (330 Ω)	B	53.6/64.2
R1707	7030007280	S.RES ERJ2GEJ 331 X (330 Ω)	B	55.6/64.8
R1708	7030007280	S.RES ERJ2GEJ 331 X (330 Ω)	B	55.6/65.7
R1901	7030005090	S.RES ERJ2GEJ 104 X (100 kΩ)	B	20/13.9
R1902	7030011290	S.RES ERJ12YJ1R8U (1.8 Ω)	B	12.4/45.8
R1952	7030009980	S.RES ERJ12RSJR15U	B	42.6/102.7
R1953	7030009980	S.RES ERJ12RSJR15U	B	42.6/99
R1954	7030005170	S.RES ERJ2GEJ 474 X (470 kΩ)	B	42.7/111.3
R1955	7030005511	S.RES ERA3YED 303V (30 kΩ)	B	44.9/108
R1956	7030005110	S.RES ERJ2GEJ 224 X (220 kΩ)	B	33.7/105.1
R1957	7030007350	S.RES ERJ2GEJ 393 X (39 kΩ)	B	35.3/104.2
R1958	7030005720	S.RES ERJ2GEJ 563 X (56 kΩ)	B	35.3/103.3
R1981	7030008240	S.RES ERJ12YJ0R00U	B	83.1/109
R2002	7030010040	S.RES ERJ2GEJ-JPW	B	36.9/12.7
R2003	7030008240	S.RES ERJ12YJ0R00U	T	55/78
R2004	7030004990	S.RES ERJ2GEJ 221 X (220 Ω)	B	59.8/9.2
R2005	7030004990	S.RES ERJ2GEJ 221 X (220 Ω)	B	59.1/3
R2006	7030004990	S.RES ERJ2GEJ 221 X (220 Ω)	B	60.7/3.7
R2007	7030004990	S.RES ERJ2GEJ 221 X (220 Ω)	B	60.7/4.6
R2008	7030010040	S.RES ERJ2GEJ-JPW	B	34/17.6
R2010	7030010040	S.RES ERJ2GEJ-JPW	B	32.5/15.1
R2011	7030006210	S.RES ERJ12YJ4R7U (4.7 Ω)	B	13.1/26.3
R2012	7030005120	S.RES ERJ2GEJ 102 X (1 kΩ)	B	32.4/17.3
R2101	7030005090	S.RES ERJ2GEJ 104 X (100 kΩ)	T	26.1/113.8
R2102	7030005090	S.RES ERJ2GEJ 104 X (100 kΩ)	T	33.1/114.3
R2103	7030005090	S.RES ERJ2GEJ 104 X (100 kΩ)	T	30.7/123.4
R2104	7030005090	S.RES ERJ2GEJ 104 X (100 kΩ)	T	28.1/123.4
R2105	7030005090	S.RES ERJ2GEJ 104 X (100 kΩ)	T	32.3/119
R2106	7030005720	S.RES ERJ2GEJ 563 X (56 kΩ)	T	25/115.5
R2107	7030005720	S.RES ERJ2GEJ 563 X (56 kΩ)	T	31.5/114.8
R2108	7030005100	S.RES ERJ2GEJ 154 X (150 kΩ)	T	30.7/122.5
R2109	7030007350	S.RES ERJ2GEJ 393 X (39 kΩ)	T	27.1/122.5
R2110	7030005090	S.RES ERJ2GEJ 104 X (100 kΩ)	T	44.3/111.8
R2111	7030005090	S.RES ERJ2GEJ 104 X (100 kΩ)	T	44.7/110
R2112	7030005090	S.RES ERJ2GEJ 104 X (100 kΩ)	T	54.1/110.8
R2113	7030005090	S.RES ERJ2GEJ 104 X (100 kΩ)	T	54.1/117.7
R2114	7030005100	S.RES ERJ2GEJ 154 X (150 kΩ)	T	44.7/112.7
R2115	7030005100	S.RES ERJ2GEJ 154 X (150 kΩ)	T	44.7/109.1
R2116	7030005100	S.RES ERJ2GEJ 154 X (150 kΩ)	T	54.4/109.9
R2117	7030005100	S.RES ERJ2GEJ 154 X (150 kΩ)	T	54.1/112.6
R2118	7030005090	S.RES ERJ2GEJ 104 X (100 kΩ)	T	54.1/120.6
R2119	7030005090	S.RES ERJ2GEJ 104 X (100 kΩ)	T	54.1/121.8
R2120	7030008300	S.RES ERJ2GEJ 184 X (180 kΩ)	T	44.8/122.1
R2121	7030008300	S.RES ERJ2GEJ 184 X (180 kΩ)	T	42.9/121.3
R2122	7030005100	S.RES ERJ2GEJ 154 X (150 kΩ)	T	54.1/119.7
R2123	7030006610	S.RES ERJ2GEJ 394 X (390 kΩ)	T	54.2/122.8
R2124	7030005110	S.RES ERJ2GEJ 224 X (220 kΩ)	T	44.8/123
R2125	7030005110	S.RES ERJ2GEJ 224 X (220 kΩ)	T	44.8/119.4
R2126	7030010040	S.RES ERJ2GEJ-JPW	T	33.1/116.6
R2128	7030005000	S.RES ERJ2GEJ 471 X (470 Ω)	T	32.3/123.4
R2129	7030005000	S.RES ERJ2GEJ 471 X (470 Ω)	T	54.1/118.8
R2131</				

[MAIN UNIT]

REF NO.	ORDER NO.	DESCRIPTION	M.	H/V LOCATION
R2135	7030005090	S.RES ERJ2GEJ 104 X (100 kΩ)	T	34.9/114.2
R2136	7030005000	S.RES ERJ2GEJ 471 X (470 Ω)	T	26.5/123.4
R2137	7030005230	S.RES ERJ2GEJ 334 X (330 kΩ)	T	43.3/123.7
R2138	7030005230	S.RES ERJ2GEJ 334 X (330 kΩ)	T	42.9/122.2
R2139	7030004980	S.RES ERJ2GEJ 101 X (100 Ω)	T	25/116.4
R2140	7030004980	S.RES ERJ2GEJ 101 X (100 Ω)	T	32/115.7
R2141	7030010040	S.RES ERJ2GEJ-JPW	T	44.7/113.6
R2142	7030010040	S.RES ERJ2GEJ-JPW	T	52.7/108.9
R2143	7030010040	S.RES ERJ2GEJ-JPW	T	56/109.9
R2144	7030010040	S.RES ERJ2GEJ-JPW	T	51.3/115.1
R2145	7030010040	S.RES ERJ2GEJ-JPW	T	58.1/123.6
R2146	7030010040	S.RES ERJ2GEJ-JPW	T	46.3/124
R2147	7030010040	S.RES ERJ2GEJ-JPW	T	46/118.5
R2151	7030005240	S.RES ERJ2GEJ 473 X (47 kΩ)	T	52.3/101.7
R2152	7030005120	S.RES ERJ2GEJ 102 X (1 kΩ)	T	56.5/107.1
R2153	7030005240	S.RES ERJ2GEJ 473 X (47 kΩ)	T	24.8/112.5
R2154	7030005120	S.RES ERJ2GEJ 102 X (1 kΩ)	T	25.6/111.6
R2155	7030005240	S.RES ERJ2GEJ 473 X (47 kΩ)	T	46.1/104.6
R2156	7030005120	S.RES ERJ2GEJ 102 X (1 kΩ)	T	46.1/105.5
R2157	7030005530	S.RES ERJ2GEJ 100 X (10 Ω)	B	33.3/120.8
R2158	7030005530	S.RES ERJ2GEJ 100 X (10 Ω)	B	33.3/119.8
R2159	7030005530	S.RES ERJ2GEJ 100 X (10 Ω)	B	35/118.3
R2160	7030005530	S.RES ERJ2GEJ 100 X (10 Ω)	B	40.7/94.3
R2161	7030005530	S.RES ERJ2GEJ 100 X (10 Ω)	B	40.7/95.2
R2162	7030005530	S.RES ERJ2GEJ 100 X (10 Ω)	B	30.2/93.8
R2163	7030005530	S.RES ERJ2GEJ 100 X (10 Ω)	B	30.9/95.9
R2164	7030005530	S.RES ERJ2GEJ 100 X (10 Ω)	B	30.2/94.7
R2165	7030005530	S.RES ERJ2GEJ 100 X (10 Ω)	B	29.3/95.9
R2166	7030005530	S.RES ERJ2GEJ 100 X (10 Ω)	T	51.8/93.3
R2167	7030005530	S.RES ERJ2GEJ 100 X (10 Ω)	T	51.8/94.2
R2168	7030005530	S.RES ERJ2GEJ 100 X (10 Ω)	T	51.8/95.1
R2169	7030005120	S.RES ERJ2GEJ 102 X (1 kΩ)	T	8.8/118.5
R2170	7030005170	S.RES ERJ2GEJ 474 X (470 kΩ)	T	5/104.5
R2171	7030005240	S.RES ERJ2GEJ 473 X (47 kΩ)	T	9.7/114.2
R2172	7030005240	S.RES ERJ2GEJ 473 X (47 kΩ)	T	5/112.4
R2174	7030005170	S.RES ERJ2GEJ 474 X (470 kΩ)	T	5/105.4
R2175	7030005170	S.RES ERJ2GEJ 474 X (470 kΩ)	T	5/111.5
R2176	7030005170	S.RES ERJ2GEJ 474 X (470 kΩ)	T	11.3/114.2
R2177	7030005210	S.RES ERJ2GEJ 822 X (8.2 kΩ)	T	3.3/108
R2202	7030010040	S.RES ERJ2GEJ-JPW	T	26.5/124.3
R2203	7030005080	S.RES ERJ2GEJ 823 X (82 kΩ)	T	25/122.4
R2204	7030005050	S.RES ERJ2GEJ 103 X (10 kΩ)	T	23.4/122.7
R2205	7030005040	S.RES ERJ2GEJ 472 X (4.7 kΩ)	T	18.2/118.2
R2206	7030007270	S.RES ERJ2GEJ 151 X (150 Ω)	T	12.6/118.8
R2207	7030005090	S.RES ERJ2GEJ 104 X (100 kΩ)	T	23.1/121.5
R2208	7030005090	S.RES ERJ2GEJ 104 X (100 kΩ)	T	19/119.2
R2209	7030004980	S.RES ERJ2GEJ 101 X (100 Ω)	T	21/116.5
R2211	7030005230	S.RES ERJ2GEJ 334 X (330 kΩ)	T	12.9/123.5
R2212	7030005310	S.RES ERJ2GEJ 124 X (120 kΩ)	T	12/124.4
R2213	7030008010	S.RES ERJ2GEJ 123 X (12 kΩ)	T	10.4/124.4
R2214	7030005050	S.RES ERJ2GEJ 103 X (10 kΩ)	T	8.8/117.6
R2215	7030005040	S.RES ERJ2GEJ 472 X (4.7 kΩ)	T	11.1/120.6
R2217	7030007280	S.RES ERJ2GEJ 331 X (330 Ω)	T	24.9/121.5
R2218	7030007270	S.RES ERJ2GEJ 151 X (150 Ω)	T	15.5/127.5
R2219	7030007280	S.RES ERJ2GEJ 331 X (330 Ω)	T	17.7/126.1
R2220	7030008280	S.RES ERJ2GEJ 271 X (270 Ω)	T	16.1/126.1
R2221	7030005050	S.RES ERJ2GEJ 103 X (10 kΩ)	T	9.5/120.5
R2230	7030010900	S.RES ERJ3GEYJ 750 V (75 Ω)	T	40.4/105.8
R2231	7030005050	S.RES ERJ2GEJ 103 X (10 kΩ)	T	4.5/118.2
R2232	7030005050	S.RES ERJ2GEJ 103 X (10 kΩ)	T	54.7/117.5
R2251	7030004990	S.RES ERJ2GEJ 221 X (220 Ω)	T	6.1/96.9
R2254	7030004990	S.RES ERJ2GEJ 221 X (220 Ω)	B	6.8/100.7
R2255	7030004990	S.RES ERJ2GEJ 221 X (220 Ω)	B	6.8/101.6
R2256	7030004990	S.RES ERJ2GEJ 221 X (220 Ω)	B	6.8/102.5
R2257	7030004990	S.RES ERJ2GEJ 221 X (220 Ω)	B	75.3/109
R2258	7030004990	S.RES ERJ2GEJ 221 X (220 Ω)	B	70.9/106.5
R2259	7030004990	S.RES ERJ2GEJ 221 X (220 Ω)	B	75.3/107.8
R2260	7030004990	S.RES ERJ2GEJ 221 X (220 Ω)	B	71/105.6
R2261	7030004990	S.RES ERJ2GEJ 221 X (220 Ω)	B	75.3/106.6
R2262	7030004990	S.RES ERJ2GEJ 221 X (220 Ω)	B	71.4/104.5
R2263	7030004990	S.RES ERJ2GEJ 221 X (220 Ω)	B	75.6/104.5
R2264	7030004990	S.RES ERJ2GEJ 221 X (220 Ω)	B	72.2/103.6
R2267	7030004990	S.RES ERJ2GEJ 221 X (220 Ω)	T	78.6/104.1
R2268	7030004990	S.RES ERJ2GEJ 221 X (220 Ω)	T	78.6/103.2
R2269	7030004990	S.RES ERJ2GEJ 221 X (220 Ω)	T	78.6/103.2
R2270	7030004970	S.RES ERJ2GEJ 470 X (47 Ω)	T	76.6/101.8
R2271	7030004990	S.RES ERJ2GEJ 221 X (220 Ω)	T	76.6/100.9
R2272	7030004990	S.RES ERJ2GEJ 221 X (220 Ω)	B	78.1/97.8
R2273	7030004990	S.RES ERJ2GEJ 221 X (220 Ω)	B	78.1/98.9
R2274	7030005000	S.RES ERJ2GEJ 471 X (470 Ω)	T	14.1/89.7
R2277	7030005090	S.RES ERJ2GEJ 104 X (100 kΩ)	T	19.2/89.5
R2278	7030005090	S.RES ERJ2GEJ 104 X (100 kΩ)	T	19.2/90.4
R2279	7030005120	S.RES ERJ2GEJ 102 X (1 kΩ)	T	66.2/107
R2280	7030004980	S.RES ERJ2GEJ 101 X (100 Ω)	B	69.7/110.2
R2281	7030004990	S.RES ERJ2GEJ 221 X (220 Ω)	T	7.1/101.5
R2301	7030007250	S.RES ERJ2GEJ 220 X (22 Ω)	T	28.3/106.6
R2302	7030008290	S.RES ERJ2GEJ 183 X (18 kΩ)	T	28.9/108
R2303	7030005710	S.RES ERJ2GEJ 121 X (120 Ω)	T	31.2/110.8
R2304	7030010900	S.RES ERA3GEYJ 750 V (75 Ω)	T	77.7/112
R2311	7030006101	S.RES ERA3YED 183V (18 kΩ)	B	67.6/107.1
R2312	7030006571	S.RES ERA3YED 392V (3.9 kΩ)	B	68.5/108.3

[MAIN UNIT]

REF NO.	ORDER NO.	DESCRIPTION	M.	H/V LOCATION
R2401	7030005000	S.RES ERJ2GEJ 471 X (470 Ω)	B	78.7/29.6
R2402	7030005050	S.RES ERJ2GEJ 103 X (10 kΩ)	B	81.3/29.6
R2405	7030010040	S.RES ERJ2GEJ-JPW	T	91.9/5.8
R2406	7030004990	S.RES ERJ2GEJ 221 X (220 Ω)	B	90.3/100.7
R2408	7030004970	S.RES ERJ2GEJ 470 X (47 Ω)	B	90.3/99.8
R2409	7030004990	S.RES ERJ2GEJ 221 X (220 Ω)	B	87.1/68.1
R2410	7030004990	S.RES ERJ2GEJ 221 X (220 Ω)	B	90.3/65.5
R2411	7030004990	S.RES ERJ2GEJ 221 X (220 Ω)	B	87.3/67.2
R2412	7030004990	S.RES ERJ2GEJ 221 X (220 Ω)	B	91.3/68.5
R2413	7030004990	S.RES ERJ2GEJ 221 X (220 Ω)	B	87.3/66.3
R2414	7030004990	S.RES ERJ2GEJ 221 X (220 Ω)	B	90.3/64.6
R2415	7030004990	S.RES ERJ2GEJ 221 X (220 Ω)	B	87.3/65.4
R2416	7030004990	S.RES ERJ2GEJ 221 X (220 Ω)	B	90.3/63.7
R2417	7030010040	S.RES ERJ2GEJ-JPW	B	43/141.4
R2418	7030010040	S.RES ERJ2GEJ-JPW	T	93.3/7.8
R2501	7030005090	S.RES ERJ2GEJ 104 X (100 kΩ)	B	8.3/93.3
R2502	7030005090	S.RES ERJ2GEJ 104 X (100 kΩ)	B	8/95.1
R2503	7030008410	S.RES ERJ2GEJ 392 X (3.9 kΩ)	B	8/91.5
R2505	7030008410	S.RES ERJ2GEJ 392 X (3.9 kΩ)	B	10.6/89.2
R2506	7030005720	S.RES ERJ2GEJ 563 X (56 kΩ)	B	9.4/90
R2507	7030004980	S.RES ERJ2GEJ 101 X (100 Ω)	B	16.4/89.9
R2508	7030005120	S.RES ERJ2GEJ 102 X (1 kΩ)	B	10.4/88.3
R2509	7030005120	S.RES ERJ2GEJ 102 X (1 kΩ)	B	15.7/88.3
R2510	7030005120	S.RES ERJ2GEJ 102 X (1 kΩ)	B	17.4/92.8
R2513	7030005000	S.RES ERJ2GEJ 471 X (470 Ω)	B	15.8/94
R2551	7030005120	S.RES ERJ2GEJ 102 X (1 kΩ)	B	42.9/123.2
R2552	7030005120	S.RES ERJ2GEJ 102 X (1 kΩ)	B	42.9/122.3
R2555	7030004980	S.RES ERJ2GEJ 101 X (100 Ω)	B	51.4/119.3
R2556	7030005040	S.RES ERJ2GEJ 472 X (4.7 kΩ)	B	44.5/125.2
R2559	7030010040	S.RES ERJ2GEJ-JPW	B	49.5/124.6
R2560	7030008410	S.RES ERJ2GEJ 392 X (3.9 kΩ)	B	49.5/125.5
R2561	7030008410	S.RES ERJ2GEJ 392 X (3.9 kΩ)	B	52.9/124.7
R2562	7030008410	S.RES ERJ2GEJ 392 X (3.9 kΩ)	B	53.9/122.8
R2564	7030005090	S.RES ERJ2GEJ 104 X (100 kΩ)	B	46.1/126.1
R2565	7030009280	S.RES ERJ2GEJ 391 X (390 Ω)	B	42/117
R2566	7030005050	S.RES ERJ2GEJ 103 X (10 kΩ)	B	59/126.8
R2567	7030005050	S.RES ERJ2GEJ 103 X (10 kΩ)	B	60.6/126.8
R2568	7030005040	S.RES ERJ2GEJ 472 X (4.7 kΩ)	B	47.8/124.7
R2569	7030005040	S.RES ERJ2GEJ 472 X (4.7 kΩ)	B	46.1/125.2
R2601	7030010040	S.RES ERJ2GEJ-JPW	B	66.7/120.4
R2602	7030005000	S.RES ERJ2GEJ 471 X (470 Ω)	B	57.2/122.6
R2603	7030005240	S.RES ERJ2GEJ 473 X (47 kΩ)	B	63.4/121.7
R2604	7030008400	S.RES ERJ2GEJ 182 X (1.8 kΩ)	B	66.7/124.3
R2605	7030005120	S.RES ERJ2GEJ 102 X (1 kΩ)	B	65.5/126
R2607	7030010040	S.RES ERJ2GEJ-JPW	T	40.4/132.4
R2608	7030009320	S.RES ERJ2GEJ 4R7 X (4.7 Ω)	B	85.4/134.1
R2611	7030005050	S.RES ERJ2GEJ 103 X (10 kΩ)	B	33.9/125.2
R2612	7030005090	S.RES ERJ2GEJ 104 X (100 kΩ)	B	38.4/126
R2613	7030005080	S.RES ERJ2GEJ 823 X (82 kΩ)	B	38.4/124.2
R2614	7030005050	S.RES ERJ2GEJ 103 X (10 kΩ)	B	34.5/127.2
R2617	7030005040	S.RES ERJ2GEJ 472 X (4.7 kΩ)	T	63.3/111.1
R2618	7030007340	S.RES ERJ2GEJ 153 X (15 kΩ)	T	69.3/112.6
R2619	7030005060	S.RES ERJ2GEJ 333 X (33 kΩ)	T	63.3/112.1
R2620	7030005120	S.RES ERJ2GEJ 102 X (1 kΩ)	T	78.1/100.3
R2621	7030005120	S.RES ERJ2GEJ 102 X (1 kΩ)	T	78.1/99.4
R2623	7030005240	S.RES ERJ2GEJ 473 X (47 kΩ)	T	9.8/112.9
R2624	7030004970	S.RES ERJ2GEJ 470 X (47 Ω)	B	86.8/122
R2628	7030005240	S.RES ERJ2GEJ 473 X (47 kΩ)	B	61.8/121.7
C5	4030017460	S.CER ECJ0EB1E102K	B	47.5/30.7
C6	4030018960	S.CER C3216 JB 1C 106MT-N	T	66.3/12
C7	4030017330	S.CER ECJ0EF1C104Z	T	73.1/13.2
C8	4030017330	S.CER ECJ0EF1C104Z	T	77.2/9
C9	4030017330	S.CER ECJ0EF1C104Z	T	73.1/15
C10	4030017330	S.CER ECJ0EF1C104Z	T	75/15.5
C11	4030017330	S.CER ECJ0EF1C104Z	T	72.7/10.1
C12	4030017330	S.CER ECJ0EF1C104Z	T	76.8/16.7
C13	4030017330	S.CER ECJ0EF1C104Z	T	73.4/18.3
C14	4030017460	S.CER ECJ0EB1E102K	T	67.7/16.5
C15	4030017460	S.CER ECJ0EB1E102K	T	63.7/15.6
C16	4030017460	S.CER ECJ0EB1E102K	T	63.6/16.5
C17	4030017460	S.CER ECJ0EB1E102K	T	60.7/16.7
C18	4030017620	S.CER ECJ0EC1H100C	T	60.8/19
C21	4030017730	S.CER ECJ0EB1E471K	T	63.7/14.7
C25	4030017580	S.CER ECJ0EC1H060C	T	55.2/17.8
C26	4030017660	S.CER ECJ0EC1H330J	T	55.2/18.7
C27	4030017780	S.CER ECJ0EB1E472K	T	51.6/20.5
C28	4030017530	S.CER ECJ0EC1H0R5B	T	53.8/17.1
C29	4030017600	S.CER ECJ0EC1H080C	T	51.7/19.6
C30	4030017730	S.CER ECJ0EB1E471K	T	45.8/17.5
C31	4030017530	S.CER ECJ0EC1H0R5B	T	53.8/17.2
C32	4030017660	S.CER ECJ0EC1H330J	T	52.1/16.4
C33	4030017580	S.CER ECJ0EC1H060C	T	52.2/16.5
C34	4030017380	S.CER ECJ0EC1H050B	T	56/15
C35	4030017380	S.CER ECJ0EC1H050B	T	55.9/12.4
C36	4030017730	S.CER ECJ0EB1E471K	T	51/15.6
C37	4030017780	S.CER ECJ0EB1E472K	T	70.4/10.6
C38	4030017780	S.CER ECJ0EB1E472K	T	45.8/18.4
C40	4030017730	S.CER ECJ0EB1E471K	T	73.1/14.1
C41	4030017730	S.CER ECJ0EB1E471K	T	66.8/

[MAIN UNIT]

REF NO.	ORDER NO.	DESCRIPTION	M.	H/V LOCATION
C42	4030017730	S.CER ECJ0EB1E471K	T	70.4/11.5
C43	4030017420	S.CER ECJ0EC1H470J	T	45.8/16.6
C44	4030017420	S.CER ECJ0EC1H470J	T	48/11.7
C50	4030017640	S.CER ECJ0EC1H150J	B	81.5/12.6
C51	4030017640	S.CER ECJ0EC1H150J	B	79.9/11.8
C52	4030017430	S.CER ECJ0EC1H101J	B	79.9/12.7
C53	4030016930	S.CER ECJ0EB1A104K	B	79.6/21.3
C54	4030016930	S.CER ECJ0EB1A104K	T	79.8/12.9
C55	4030016930	S.CER ECJ0EB1A104K	T	78.5/17.9
C56	4030018860	S.CER ECJ0EB0J105K	B	66.9/22.7
C58	4030017710	S.CER ECJ0EC1H181J	T	71.1/19.7
C59	4030017710	S.CER ECJ0EC1H181J	T	66.3/23.7
C101	4030017330	S.CER ECJ0EF1C104Z	T	10.3/15.5
C102	4030017330	S.CER ECJ0EF1C104Z	T	13.2/16.9
C103	4030017330	S.CER ECJ0EF1C104Z	T	13.2/17.8
C104	4030017330	S.CER ECJ0EF1C104Z	T	3.3/29.9
C105	4030017330	S.CER ECJ0EF1C104Z	T	13.2/19.6
C106	4030017850	S.CER C2012 CH 1H 272J-T	T	23.7/10.9
C107	4030017330	S.CER ECJ0EF1C104Z	T	19.2/12.9
C108	4030017330	S.CER ECJ0EF1C104Z	T	36.5/16.6
C109	4030017330	S.CER ECJ0EF1C104Z	T	25.2/14
C110	4030017800	S.CER C1608 CH 1H 561J-T	T	27.8/7.6
C111	4030018590	S.CER C1608 CH 1H 122J-T	T	28.8/5
C112	4030017330	S.CER ECJ0EF1C104Z	T	25/5.7
C114	4030018600	S.CER C1608 CH 1H 152J-T	T	25.1/15
C115	4030008490	S.CER C2012 JB 1H 682K-T	T	24.8/16.7
C116	4030017850	S.CER C2012 CH 1H 272J-T	T	24.8/18.4
C117	4030017330	S.CER ECJ0EF1C104Z	T	19.3/5.8
C118	4030017330	S.CER ECJ0EF1C104Z	T	38.2/17.5
C119	4030017780	S.CER ECJ0EB1E472K	T	7.8/22.2
C120	4030017330	S.CER ECJ0EF1C104Z	T	7.8/21.3
C121	4030017330	S.CER ECJ0EF1C104Z	T	5.7/12.9
C122	4030017330	S.CER ECJ0EF1C104Z	T	13.2/18.7
C123	4030017330	S.CER ECJ0EF1C104Z	T	15.4/14.3
C124	4030017330	S.CER ECJ0EF1C104Z	T	16.3/15.3
C125	4030017460	S.CER ECJ0EB1E102K	T	40/21.7
C126	4030017460	S.CER ECJ0EB1E102K	T	37/22.3
C127	4030017460	S.CER ECJ0EB1E102K	B	19.2/23
C208	4030017330	S.CER ECJ0EF1C104Z	T	19.7/31.2
C209	4030017680	S.CER ECJ0EC1H820J	T	18.5/41.4
C210	4030017610	S.CER ECJ0EC1H090C	T	18.5/40.5
C211	4030017700	S.CER ECJ0EC1H151J	T	18.5/42.3
C212	4030017650	S.CER ECJ0EC1H270J	T	23.2/39.2
C213	4030017510	S.CER ECJ0EC1H680J	T	21.8/43.4
C214	4030018820	S.CER ECJ0EB1H561K	T	31.7/54.4
C215	4030017440	S.CER ECJ0EC1H221J	T	37/54.6
C226	4030017330	S.CER ECJ0EF1C104Z	T	24.1/43.4
C227	4030017330	S.CER ECJ0EF1C104Z	T	19.7/30.3
C228	4030017430	S.CER ECJ0EC1H101J	T	28.1/39.2
C229	4030017440	S.CER ECJ0EC1H221J	T	29.7/39.2
C237	4030017500	S.CER ECJ0EB1H560J	T	28.1/38.2
C238	4030017330	S.CER ECJ0EF1C104Z	T	21.9/30.9
C239	4030017330	S.CER ECJ0EF1C104Z	B	24.7/41.4
C240	4030017400	S.CER ECJ0EC1H220J	B	28.1/43.6
C241	4030017580	S.CER ECJ0EC1H060C	B	31.5/40.1
C242	4030017680	S.CER ECJ0EC1H820J	B	31.5/41
C243	4030018630	S.CER C2012 CH 1H 472J-T	T	32.5/57.8
C244	4030018680	S.CER C2012 CH 1H 822J-T	T	36.8/57.8
C245	4030017330	S.CER ECJ0EF1C104Z	T	45.8/63.2
C246	4030018600	S.CER C1608 CH 1H 152J-T	T	36.5/56.1
C247	4030017860	S.CER C2012 CH 1H 332J-T	T	40.3/54.1
C248	4030018630	S.CER C2012 CH 1H 472J-T	T	43.8/57.9
C249	4030017330	S.CER ECJ0EF1C104Z	B	24.9/56.4
C250	4030017330	S.CER ECJ0EF1C104Z	B	24.9/53.3
C251	4030018590	S.CER C1608 CH 1H 122J-T	T	30.5/51
C252	4030011340	S.CER C1608 CH 1H 471J-T	T	31.9/48.6
C253	4030018630	S.CER C2012 CH 1H 472J-T	T	29.1/53.3
C254	4030018620	S.CER C1608 CH 1H 222J-T	T	38.1/50.8
C255	4030018580	S.CER C1608 CH 1H 821J-T	T	32.6/55.9
C256	4030010760	S.CER C1608 CH 1H 331J-T	T	38.1/52.1
C257	4030018610	S.CER C1608 CH 1H 182J-T	T	34.4/53.4
C258	4030017870	S.CER C1608 CH 1H 681J-T	T	40.7/52.2
C259	4030018590	S.CER C1608 CH 1H 122J-T	T	37.1/53.4
C260	4030017870	S.CER C1608 CH 1H 681J-T	T	40.7/47.9
C261	4030017780	S.CER ECJ0EB1E472K	B	37.9/56.2
C262	4030017780	S.CER ECJ0EB1E472K	B	37.9/53.8
C263	4030017330	S.CER ECJ0EF1C104Z	B	24.5/50.2
C264	4030017330	S.CER ECJ0EF1C104Z	B	23.9/47.1
C265	4030011280	S.CER C1608 CH 1H 271J-T	B	36.4/46
C266	4030017700	S.CER ECJ0EC1H151J	B	31/44.1
C267	4030018590	S.CER C1608 CH 1H 122J-T	B	36.4/49.6
C268	4030018580	S.CER C1608 CH 1H 821J-T	B	31.7/42.9
C269	4030017710	S.CER ECJ0EC1H181J	B	36.5/47.1
C270	4030017430	S.CER ECJ0EC1H101J	B	32.6/44.1
C271	4030011330	S.CER C1608 CH 1H 391J-T	B	36.4/48.3
C272	4030011280	S.CER C1608 CH 1H 271J-T	B	36.3/43.8
C273	4030011330	S.CER C1608 CH 1H 391J-T	B	38.8/47.3
C274	4030017730	S.CER ECJ0EB1E471K	B	34.2/43.7
C275	4030017780	S.CER ECJ0EB1E472K	B	42.9/49.6
C276	4030017780	S.CER ECJ0EB1E472K	B	39.2/46.2
C278	4030017330	S.CER ECJ0EF1C104Z	T	30.9/31.8

[MAIN UNIT]

REF NO.	ORDER NO.	DESCRIPTION	M.	H/V LOCATION
C279	4030017330	S.CER ECJ0EF1C104Z	T	31/43.8
C281	4030017330	S.CER ECJ0EF1C104Z	T	33/31.7
C282	4030017580	S.CER ECJ0EC1H060C	B	31.5/39.2
C283	4030017330	S.CER ECJ0EF1C104Z	B	35.8/35.8
C284	4030017780	S.CER ECJ0EB1E472K	B	42.6/43.3
C285	4030017380	S.CER ECJ0EC1H050B	B	33.1/39.5
C286	4030017510	S.CER ECJ0EC1H680J	B	34.7/39.5
C287	4030017690	S.CER ECJ0EC1H121J	B	36.5/37.8
C288	4030017680	S.CER ECJ0EC1H820J	B	34.2/36.3
C289	4030017420	S.CER ECJ0EC1H470J	B	36.3/36.7
C290	4030018600	S.CER C1608 CH 1H 152J-T	B	38.8/37.6
C291	4030017680	S.CER ECJ0EC1H820J	B	37.9/36.5
C292	4030017330	S.CER ECJ0EF1C104Z	T	30.9/30
C293	4030017780	S.CER ECJ0EB1E472K	B	38.1/34.8
C294	4030017440	S.CER ECJ0EC1H221J	T	38.6/49.6
C295	4030017510	S.CER ECJ0EC1H680J	T	40.4/51.2
C301	4030017330	S.CER ECJ0EF1C104Z	T	47/30.1
C302	4030017330	S.CER ECJ0EF1C104Z	B	56.1/30.7
C303	4030017330	S.CER ECJ0EF1C104Z	T	51.5/33.6
C305	4030017330	S.CER ECJ0EF1C104Z	T	59.9/34.7
C307	4030017330	S.CER ECJ0EF1C104Z	T	59.9/35.6
C308	4030017330	S.CER ECJ0EF1C104Z	T	60.7/36.5
C309	4030017330	S.CER ECJ0EF1C104Z	T	62.8/36.9
C310	4030017330	S.CER ECJ0EF1C104Z	T	69.0/30.1
C311	4030017330	S.CER ECJ0EF1C104Z	T	50.1/32.6
C312	4030017330	S.CER ECJ0EF1C104Z	T	64.5/36.1
C313	4030017380	S.CER ECJ0EC1H050B	T	46.4/23
C314	4030017660	S.CER ECJ0EC1H330J	T	64.8/35.2
C315	4030017340	S.CER ECJ0EC1H010B	T	49.2/22.9
C316	4030017630	S.CER ECJ0EC1H120J	T	66.1/36.1
C317	4030017600	S.CER ECJ0EC1H080C	T	51.4/23.8
C318	4030017680	S.CER ECJ0EC1H820J	T	66.4/35.2
C319	4030017570	S.CER ECJ0EC1H040B	T	53/24.3
C320	4030017570	S.CER ECJ0EC1H040B	T	69.6/37.1
C321	4030017580	S.CER ECJ0EC1H060C	T	58.6/24.4
C322	4030017670	S.CER ECJ0EC1H390J	T	69/32.2
C323	4030017590	S.CER ECJ0EC1H070C	T	60.4/24.2
C324	4030017330	S.CER ECJ0EF1C104Z	T	74.7/38.6
C325	4030017360	S.CER ECJ0EC1H030B	T	62/24.6
C326	4030017780	S.CER ECJ0EB1E472K	T	47.6/47.1
C401	4030017330	S.CER ECJ0EF1C104Z	T	71/30.8
C413	4030017330	S.CER ECJ0EF1C104Z	T	80.6/23.9
C415	4030017330	S.CER ECJ0EF1C104Z	T	73.1/24.4
C418	4030017330	S.CER ECJ0EF1C104Z	T	67.9/24.8
C422	4030017330	S.CER ECJ0EF1C104Z	T	80/28.6
C423	4030017330	S.CER ECJ0EF1C104Z	T	68.3/23.9
C424	4030017330	S.CER ECJ0EF1C104Z	T	83.2/21
C425	4030017330	S.CER ECJ0EF1C104Z	T	86.9/27.6
C426	4030017330	S.CER ECJ0EF1C104Z	T	78.6/19.8
C427	4030017330	S.CER ECJ0EF1C104Z	T	80/27.7
C429	4030017460	S.CER ECJ0EB1E102K	T	81.6/25.3
C431	4030017330	S.CER ECJ0EF1C104Z	T	88.5/25.9
C432	4030017780	S.CER ECJ0EB1E472K	B	88.5/19.3
C433	4030017780	S.CER ECJ0EB1E472K	B	88.8/20.3
C434	4030017780	S.CER ECJ0EB1E472K	T	86.2/22.9
C511	4030017460	S.CER ECJ0EB1E102K	T	41.8/26.8
C512	4030017780	S.CER ECJ0EB1E472K	T	93.1/32.9
C513	4030017330	S.CER ECJ0EF1C104Z	T	88.4/28.3
C514	4030017330	S.CER ECJ0EF1C104Z	B	86.3/31.7
C515	4030017780	S.CER ECJ0EB1E472K	T	81.7/33.2
C516	4030017580	S.CER ECJ0EC1H060C	T	86.1/38.7
C518	4030017570	S.CER ECJ0EC1H040B	T	86.8/36.7
C525	4030017330	S.CER ECJ0EF1C104Z	T	81.8/32.3
C526	4030016790	S.CER ECJ0EB1C103K	T	77.7/38
C527	4030017330	S.CER ECJ0EF1C104Z	T	79.3/37.9
C528	4030017330	S.CER ECJ0EF1C104Z	T	89.7/35.1
C529	4030017670	S.CER ECJ0EC1H390J	T	91.3/33.8
C530	4030017460	S.CER ECJ0EB1E102K	B	87.7/34.1
C602	4030017570	S.CER ECJ0EC1H040B	B	85.7/39.6
C603	4030017780	S.CER ECJ0EB1E472K	T	89.1/40.1
C604	4030017780	S.CER ECJ0EB1E472K	T	94/46.5
C605	4030017620	S.CER ECJ0EC1H100C	T	86/43.9
C606	4030017620	S.CER ECJ0EC1H100C	B	85.7/41.4
C608	4030017550	S.CER ECJ0EC1H1R5B	B	82.7/43.8
C609	4030017580	S.CER ECJ0EC1H060C	B	78.6/46.8
C610	4030017620	S.CER ECJ0EC1H100C	B	80.7/48.1
C611	4030017780	S.CER ECJ0EB1E472K	B	85.1/37.5
C612	4030017610	S.CER ECJ0EC1H090C	T	79.5/40.5
C613	4030017620	S.CER ECJ0EC1H100C	T	76.5/43.7
C614	4030017780	S.CER ECJ0EB1E472K	T	69.6/38.8
C615	4030017780	S.CER ECJ0EB1E472K	T	64.3/43
C616	4030017780	S.CER ECJ0EB1E472K	T	77.4/39.5
C617	4030017620	S.CER ECJ0EC1H100C	B	85.7/40.5
C618	4030017620	S.CER ECJ0EC1H100C	B	80.7/49
C701	4030017330	S.CER ECJ0EF1C104Z	T	59/50.6
C702	4030017330	S.CER ECJ0EF1C104Z	T	63/45
C703	4510008630	S.ELLE 16 CE 47 FE	B	59/44.9
C704	4030017780	S.CER ECJ0EB1E472K	T	58.6/42.9
C705	4030017600	S.CER ECJ0EC1H080C	T	59.6/45.1
C707	4030017330	S.CER ECJ0EF1C104Z	T	64.2/52.9
C708	4030017460	S.CER ECJ0EB1E102K	T	64.5/55

M.=Mounted side (T: Mounted on the Top side, B: Mounted on the Bottom side)
S.=Surface mount

[MAIN UNIT]

REF NO.	ORDER NO.	DESCRIPTION	M.	H/V LOCATION
C709	4030017780	S.CER ECJ0EB1E472K	T	60.7/58.6
C710	4030017780	S.CER ECJ0EB1E472K	T	62.3/58.6
C711	4030017460	S.CER ECJ0EB1E102K	T	57.1/50.6
C712	4030017600	S.CER ECJ0EJC1H080C	T	53/49.7
C714	4030017460	S.CER ECJ0EB1E102K	T	55.5/49.7
C715	4030017780	S.CER ECJ0EB1E472K	T	52.1/53.2
C716	4030017340	S.CER ECJ0EJC1H010B	T	55.3/55.1
C717	4030017780	S.CER ECJ0EB1E472K	T	51.2/52.3
C718	4030017780	S.CER ECJ0EB1E472K	T	56.9/55.1
C719	4030017340	S.CER ECJ0EJC1H010B	T	61.1/53.9
C720	4030017380	S.CER ECJ0EJC1H050B	T	59.3/42
C721	4030017780	S.CER ECJ0EB1E472K	T	51.2/49.6
C801	4030017330	S.CER ECJ0EJC1H04Z	T	71.5/64
C803	4030017780	S.CER ECJ0EB1E472K	T	65.3/61.8
C804	4030017330	S.CER ECJ0EJC1H04Z	T	91.9/58
C805	4030017460	S.CER ECJ0EB1E102K	T	83.5/55.8
C807	4030017330	S.CER ECJ0EJC1H04Z	T	60.6/66.7
C808	4030017870	S.CER C1608 CH 1H 681J-T	T	60.3/65.5
C809	4030018630	S.CER C2012 CH 1H 472J-T	T	57.4/66.8
C810	4030017700	S.CER ECJ0EJC1H151J	T	63.9/68.5
C811	4030017700	S.CER ECJ0EJC1H151J	T	63.9/69.4
C812	4030017700	S.CER ECJ0EJC1H151J	T	60.1/69.4
C813	4030017700	S.CER ECJ0EJC1H151J	T	60.1/68.5
C814	4030017330	S.CER ECJ0EJC1H04Z	T	88.5/57.1
C815	4030017460	S.CER ECJ0EB1E102K	T	86.6/60.6
C816	4030017400	S.CER ECJ0EJC1H220J	T	85.7/59.7
C817	4030017400	S.CER ECJ0EJC1H220J	T	84/61.7
C818	4030018590	S.CER C1608 CH 1H 122J-T	T	54.6/65.6
C819	4030017850	S.CER C2012 CH 1H 272J-T	T	51.6/65.8
C901	4030017330	S.CER ECJ0EJC1H04Z	T	38.4/71.3
C910	4030017710	S.CER ECJ0EJC1H181J	T	39.2/65.6
C911	4030017700	S.CER ECJ0EJC1H151J	T	47.9/74.7
C913	4030017330	S.CER ECJ0EJC1H04Z	T	38.2/61.1
C914	4030017330	S.CER ECJ0EJC1H04Z	T	39.2/63.6
C915	4030017330	S.CER ECJ0EJC1H04Z	T	36.8/69.1
C916	4030017330	S.CER ECJ0EJC1H04Z	T	33.9/61.9
C917	4030017780	S.CER ECJ0EB1E472K	T	35.6/63.2
C918	4030017330	S.CER ECJ0EJC1H04Z	T	34.2/67.5
C920	4030017460	S.CER ECJ0EB1E102K	T	38.4/74.2
C921	4030017330	S.CER ECJ0EJC1H04Z	T	34.2/70.2
C922	4030017330	S.CER ECJ0EJC1H04Z	T	29.4/73
C923	4030017330	S.CER ECJ0EJC1H04Z	T	29.9/72.1
C924	4030017780	S.CER ECJ0EB1E472K	T	41.2/74.1
C925	4030017700	S.CER ECJ0EJC1H151J	B	31.4/73
C1001	4030017780	S.CER ECJ0EB1E472K	T	31.7/71.2
C1009	4030017780	S.CER ECJ0EB1E472K	T	25.8/72
C1016	4030017330	S.CER ECJ0EJC1H04Z	T	25.8/73.8
C1018	4030017460	S.CER ECJ0EB1E102K	T	20.3/76
C1019	4030017330	S.CER ECJ0EJC1H04Z	T	15.2/76.9
C1020	4030017330	S.CER ECJ0EJC1H04Z	T	12.7/75.8
C1021	4030017330	S.CER ECJ0EJC1H04Z	T	4.6/78.9
C1022	4510008630	S.ELE 16 CE 47 FE	B	6.1/86
C1023	4510008630	S.ELE 16 CE 47 FE	B	5.7/77.4
C1101	4030017490	S.CER C1608 JB 1A 105K-T	T	2.5/78.9
C1102	4030017330	S.CER ECJ0EJC1H04Z	T	4.6/78
C1104	4030017490	S.CER C1608 JB 1A 105K-T	T	2.5/87.8
C1105	4030018960	S.CER C3216 JB 1C 106MT-N	T	2.9/89.7
C1108	4030017330	S.CER ECJ0EJC1H04Z	T	2.3/91.3
C1201	4030017330	S.CER ECJ0EJC1H04Z	T	2.6/80.6
C1202	4030017330	S.CER ECJ0EJC1H04Z	T	28.7/80.5
C1203	4030017330	S.CER ECJ0EJC1H04Z	T	18.6/79.2
C1204	4030018960	S.CER C3216 JB 1C 106MT-N	T	9/76.9
C1206	4030017780	S.CER ECJ0EB1E472K	T	14.3/79.4
C1207	4030017780	S.CER ECJ0EB1E472K	T	14.3/78.5
C1208	4030018080	S.CER ECJ0EB1H182K	T	12.9/85
C1209	4030018820	S.CER ECJ0EB1H561K	T	12.9/84.1
C1210	4030017780	S.CER ECJ0EB1E472K	T	11.3/84.1
C1211	4030017490	S.CER C1608 JB 1A 105K-T	T	9.2/84.5
C1212	4030017490	S.CER C1608 JB 1A 105K-T	T	6.7/87.8
C1213	4030017330	S.CER ECJ0EJC1H04Z	T	21.8/78.3
C1301	4030017330	S.CER ECJ0EJC1H04Z	T	15.2/73.6
C1302	4030017330	S.CER ECJ0EJC1H04Z	T	15.1/67.3
C1303	4030018860	S.CER ECJ0EBOJ105K	T	11.3/67.3
C1304	4030017330	S.CER ECJ0EJC1H04Z	T	14.3/69.2
C1305	4030017330	S.CER ECJ0EJC1H04Z	T	11.6/65.5
C1306	4030017330	S.CER ECJ0EJC1H04Z	T	10.9/60.3
C1307	4030017330	S.CER ECJ0EJC1H04Z	T	16.2/65.6
C1308	4030017330	S.CER ECJ0EJC1H04Z	T	14.5/60.3
C1309	4030017330	S.CER ECJ0EJC1H04Z	T	3.8/50.8
C1310	4030017330	S.CER ECJ0EJC1H04Z	T	16.2/62.9
C1311	4030018960	S.CER C3216 JB 1C 106MT-N	T	5.4/58.5
C1312	4030018860	S.CER ECJ0EBOJ105K	T	13/66.4
C1401	4030017330	S.CER ECJ0EJC1H04Z	B	46.6/77.3
C1402	4030017700	S.CER ECJ0EJC1H151J	B	42/69
C1403	4030017650	S.CER ECJ0EJC1H270J	B	45.5/71.4
C1404	4030017700	S.CER ECJ0EJC1H151J	B	41.9/70.5
C1405	4030017780	S.CER ECJ0EB1E472K	B	43.6/71.4
C1406	4030017780	S.CER ECJ0EB1E472K	B	42/72.4
C1407	4030017780	S.CER ECJ0EB1E472K	B	44.6/74.3
C1408	4030017780	S.CER ECJ0EB1E472K	B	40.3/79
C1409	4030017780	S.CER ECJ0EB1E472K	B	34.7/79

[MAIN UNIT]

REF NO.	ORDER NO.	DESCRIPTION	M.	H/V LOCATION
C1411	4030018860	S.CER ECJ0EBOJ105K	B	27/79.9
C1412	4030016950	S.CER ECJ0EB1A473K	B	27/80.8
C1413	4030017490	S.CER C1608 JB 1A 105K-T	B	20.7/77.4
C1414	4030016950	S.CER ECJ0EB1A473K	B	25/77.8
C1415	4510008640	S.ELE 6 CE 100 FE	B	13.2/81.5
C1416	4030016950	S.CER ECJ0EB1A473K	B	20.2/78.5
C1418	4030017350	S.CER ECJ0EJC1H020B	B	23/86.6
C1419	4030018390	S.CER ECJ0EB1A563K	B	23/87.5
C1420	4030017420	S.CER ECJ0EJC1H470J	B	17.8/83
C1421	4030018960	S.CER C3216 JB 1C 106MT-N	B	19.8/87.3
C1422	4030017640	S.CER ECJ0EJC1H150J	B	17.8/82.1
C1423	4610001970	S.TRI TZC3P200A110R00	T	3.8/72.5
C1491	4030017400	S.CER ECJ0EJC1H220J	[USA]	B 88.2/29.3
	4030017670	S.CER ECJ0EJC1H390J	[Others]	B 88.2/29.3
C1493	4030017660	S.CER ECJ0EJC1H330J	B	86.1/33.7
C1494	4030017420	S.CER ECJ0EJC1H470J	[USA]	B 83.6/34
	4030017670	S.CER ECJ0EJC1H390J	[Others]	B 83.6/34
C1495	4030010760	S.CER C1608 CH 1H 331J-T	[USA]	B 84/32.9
	4030011280	S.CER C1608 CH 1H 271J-T	[Others]	B 84/32.9
C1496	4030017660	S.CER ECJ0EJC1H330J	B	79.3/35.2
C1498	4030017400	S.CER ECJ0EJC1H220J	[USA]	B 79.3/36.3
	4030017670	S.CER ECJ0EJC1H390J	[Others]	B 79.3/36.3
C1501	4030017410	S.CER ECJ0EJC1H240J	B	79.3/37.2
C1503	4030017330	S.CER ECJ0EJC1H04Z	B	78.9/61.9
C1504	4030017510	S.CER ECJ0EJC1H680J	B	80.9/36.3
C1506	4030017780	S.CER ECJ0EB1E472K	B	92.1/28.8
C1507	4030017410	S.CER ECJ0EJC1H240J	B	82.5/36.2
C1508	4030017780	S.CER ECJ0EB1E472K	B	77.3/38.6
C1509	4030017780	S.CER ECJ0EB1E472K	B	72.4/39.1
C1510	4030017780	S.CER ECJ0EB1E472K	B	72.4/41.2
C1511	4030016790	S.CER ECJ0EB1C103K	B	86.4/56.2
C1512	4030017780	S.CER ECJ0EB1E472K	B	77/41.6
C1513	4030018900	S.CER ECJ0EBOJ474K	B	71.7/54.8
C1514	4030017780	S.CER ECJ0EB1E472K	B	73.5/42.1
C1515	4030018960	S.CER C3216 JB 1C 106MT-N	B	68.3/52.7
C1516	4030017330	S.CER ECJ0EJC1H04Z	B	77.6/49
C1517	4030017730	S.CER ECJ0EB1E471K	B	73.6/53.9
C1518	4030016790	S.CER ECJ0EB1C103K	B	85.7/51.4
C1519	4030018960	S.CER C3216 JB 1C 106MT-N	B	69.3/47.4
C1520	4510008630	S.ELE 16 CE 47 FE	B	91/45.4
C1521	4030017680	S.CER ECJ0EJC1H820J	B	85.9/58
C1522	4030017670	S.CER ECJ0EJC1H390J	T	73.2/55.3
C1523	4030017330	S.CER ECJ0EJC1H04Z	T	31.2/80.4
C1524	4030017420	S.CER ECJ0EJC1H470J	[Others]	B 73.6/60.5
	4030017510	S.CER ECJ0EJC1H680J	[USA]	B 73.6/60.5
C1525	4030018900	S.CER ECJ0EBOJ474K	B	85.8/59.9
C1526	4030018960	S.CER C3216 JB 1C 106MT-N	B	69.3/47.4
C1531	4030017490	S.CER C1608 JB 1A 105K-T	B	82.8/51.5
C1532	4030017780	S.CER ECJ0EB1E472K	B	81.9/41.3
C1533	4030017780	S.CER ECJ0EB1E472K	B	81.9/39.4
C1534	4030017780	S.CER ECJ0EB1E472K	B	83.5/38.5
C1601	4030017780	S.CER ECJ0EB1E472K	T	6.3/52.2
C1604	4030017780	S.CER ECJ0EB1E472K	T	5.6/50.8
C1605	4030017330	S.CER ECJ0EJC1H04Z	T	8.8/48.7
C1607	4030017780	S.CER ECJ0EB1E472K	T	14.7/46
C1609	4030017490	S.CER C1608 JB 1A 105K-T	T	14.1/33.6
C1610	4030017330	S.CER ECJ0EJC1H04Z	T	12.1/44.7
C1611	4030017330	S.CER ECJ0EJC1H04Z	T	14.6/41.1
C1613	4030017330	S.CER ECJ0EJC1H04Z	T	18.9/47.1
C1614	4030017730	S.CER ECJ0EB1E471K	T	15/36.1
C1615	4030017420	S.CER ECJ0EJC1H470J	T	10.4/46.9
C1616	4550007260	S.TAN F931C475MAABMA	T	9.6/50.5
C1618	4030017430	S.CER ECJ0EJC1H101J	T	12.7/26.3
C1701	4030017490	S.CER C1608 JB 1A 105K-T	B	55.1/50.4
C1702	4030017490	S.CER C1608 JB 1A 105K-T	B	55/69.6
C1801	4030017330	S.CER ECJ0EJC1H04Z	B	18.4/105
C1802	4510008630	S.ELE 16 CE 47 FE	B	14.4/101.2
C1803	4030018960	S.CER C3216 JB 1C 106MT-N	B	22.3/112.1
C1804	4030017330	S.CER ECJ0EJC1H04Z	B	22.8/110.6
C1901	4030017330	S.CER ECJ0EJC1H04Z	T	36.2/80.4
C1902	4030017330	S.CER ECJ0EJC1H04Z	T	33.7/80.4
C1903	4030017330	S.CER ECJ0EJC1H04Z	B	23.3/18.8
C1904	4030017330	S.CER ECJ0EJC1H04Z	B	32.5/89.8
C1905	4030017330	S.CER ECJ0EJC1H04Z	B	25.9/33.8
C1906	4030017330	S.CER ECJ0EJC1H04Z	B	25.9/32.9
C1907	4030017330	S.CER ECJ0EJC1H04Z	T	41.6/80.3
C1908	4030017330	S.CER ECJ0EJC1H04Z	T	38.4/80.7
C1909	4030017330	S.CER ECJ0EJC1H04Z	B	21.6/13.9
C1910	4030017460	S.CER ECJ0EB1E102K	B	45.4/25.4
C1916	4030018960	S.CER C3216 JB 1C 106MT-N	B	14.7/50.0
C1917	4030018960	S.CER C3216 JB 1C 106MT-N	B	5.3/52.7
C1951	4030018960	S.CER C3216 JB 1C 106MT-N	B	48.1/103.1
C1952	4030018960	S.CER C3216 JB 1C 106MT-N	B	48.1/98.9
C1953	4030018960	S.CER C3216 JB 1C 106MT-N	B	48.1/96.8
C1954	4030018960	S.CER C3216 JB 1C 106MT-N	B	48.2/105.2
C1955	4030018960	S.CER C3216 JB 1C 106MT-N	B	48.1/101
C1956	4030018960	S.CER C3216 JB 1C 106MT-N	B	60.9/118.7
C1957	4030017330	S.CER ECJ0EJC1H04Z	B	63.8/116.7
C1958	4030018910	S.CER C1608 JB 0J 475K-T	B	20.9/125.7
C1959	4550007090	S.TAN TEESVA 1A 226M8R	B	11.4/120.2
C1960	4030010210	S.CER C3216 JB 1C 105M-T	B	47.3/109.7

M.=Mounted side (T: Mounted on the Top side, B: Mounted on the Bottom side)
S.=Surface mount

[MAIN UNIT]

REF NO.	ORDER NO.	DESCRIPTION	M.	H/V LOCATION
C1961	4030017730	S.CER ECJ0EB1E471K	B	44/110
C1962	4030017440	S.CER ECJ0EC1H221J	B	44.4/107
C1963	4030017500	S.CER ECJ0EC1H560J	B	35.3/105.1
C1964	4030017330	S.CER ECJ0EF1C104Z	B	44.3/111.3
C1965	4030018960	S.CER C3216 JB 1C 106MT-N	B	7.4/108
C1966	4030017330	S.CER ECJ0EF1C104Z	B	10.1/103
C1968	4030018960	S.CER C3216 JB 1C 106MT-N	B	31.7/103.6
C1969	4030018970	S.CER C3225 JB 1C 226MT-N	B	30.8/100.9
C1970	4030018970	S.CER C3225 JB 1C 226MT-N	B	30.8/97.9
C1971	4030017330	S.CER ECJ0EF1C104Z	B	45.9/111.3
C1972	4030017330	S.CER ECJ0EF1C104Z	B	47.6/106.7
C1973	4030017330	S.CER ECJ0EF1C104Z	B	32.1/105.1
C2001	4030017780	S.CER ECJ0EB1E472K	T	33.2/10.3
C2002	4030017330	S.CER ECJ0EF1C104Z	B	71.7/14.6
C2003	4030017780	S.CER ECJ0EB1E472K	B	58.8/15.8
C2004	4030017780	S.CER ECJ0EB1E472K	B	83/5.9
C2005	4030017780	S.CER ECJ0EB1E472K	B	69.2/16.5
C2006	4030017330	S.CER ECJ0EF1C104Z	B	83/6.8
C2007	4030017780	S.CER ECJ0EB1E472K	B	84.6/5.9
C2008	4030017330	S.CER ECJ0EF1C104Z	B	56.7/10.1
C2009	4030017330	S.CER ECJ0EF1C104Z	B	75.8/18.6
C2010	4030017780	S.CER ECJ0EB1E472K	B	75.9/6.7
C2011	4030017330	S.CER ECJ0EF1C104Z	B	75/7.7
C2012	4030017780	S.CER ECJ0EB1E472K	B	63.1/15.5
C2013	4030017330	S.CER ECJ0EF1C104Z	B	88.9/2
C2014	4030017780	S.CER ECJ0EB1E472K	B	32.5/11.8
C2015	4030017780	S.CER ECJ0EB1E472K	B	32.5/12.7
C2016	4030017780	S.CER ECJ0EB1E472K	B	19/131.2
C2017	4030017330	S.CER ECJ0EF1C104Z	T	86.4/10.2
C2018	4030017780	S.CER ECJ0EB1E472K	B	42.7/17.7
C2019	4030017780	S.CER ECJ0EB1E472K	T	24.7/126.7
C2020	4030017330	S.CER ECJ0EF1C104Z	B	85/23.1
C2021	4030017780	S.CER ECJ0EB1E472K	B	32.5/16
C2022	4030017780	S.CER ECJ0EB1E472K	B	30.3/130.2
C2024	4030017780	S.CER ECJ0EB1E472K	B	29.1/128.2
C2025	4030017780	S.CER ECJ0EB1E472K	B	45.7/12.8
C2026	4030018960	S.CER C3216 JB 1C 106MT-N	B	10.1/23.4
C2027	4030018960	S.CER C3216 JB 1C 106MT-N	B	10.1/14.6
C2028	4030017330	S.CER ECJ0EF1C104Z	B	51.7/12.7
C2029	4030017330	S.CER ECJ0EF1C104Z	B	58.1/9.4
C2030	4030017330	S.CER ECJ0EF1C104Z	B	55.8/15.8
C2032	4030017780	S.CER ECJ0EB1E472K	B	27.4/129
C2033	4030017330	S.CER ECJ0EF1C104Z	B	71.1/21.9
C2034	4030017780	S.CER ECJ0EB1E472K	B	64.8/5.6
C2035	4030017780	S.CER ECJ0EB1E472K	B	25.6/130.2
C2036	4030017330	S.CER ECJ0EF1C104Z	B	88.2/8
C2037	4030017330	S.CER ECJ0EF1C104Z	B	76/16.5
C2038	4030017780	S.CER ECJ0EB1E472K	T	14.5/126.4
C2039	4030017780	S.CER ECJ0EB1E472K	B	80.2/6.7
C2040	4030017780	S.CER ECJ0EB1E472K	B	64.6/17.7
C2041	4030017330	S.CER ECJ0EF1C104Z	B	75.2/10.5
C2042	4030017330	S.CER ECJ0EF1C104Z	B	62.7/18.1
C2043	4030017780	S.CER ECJ0EB1E472K	B	55.4/8.8
C2044	4030017780	S.CER ECJ0EB1E472K	B	62.7/19.5
C2045	4030017780	S.CER ECJ0EB1E472K	B	65.3/22.3
C2046	4030017780	S.CER ECJ0EB1E472K	B	63.6/14.6
C2047	4030017780	S.CER ECJ0EB1E472K	B	57.7/21.9
C2048	4030017780	S.CER ECJ0EB1E472K	B	63.1/5.6
C2049	4030017780	S.CER ECJ0EB1E472K	T	45.1/101.8
C2050	4030017780	S.CER ECJ0EB1E472K	T	42.8/100.3
C2051	4030017330	S.CER ECJ0EF1C104Z	T	56.3/99.9
C2052	4030017780	S.CER ECJ0EB1E472K	T	21.6/108
C2053	4030017780	S.CER ECJ0EB1E472K	T	49.8/107.5
C2054	4030018960	S.CER C3216 JB 1C 106MT-N	B	55.3/83.4
C2055	4030018960	S.CER C3216 JB 1C 106MT-N	B	28.1/88.5
C2058	4030018960	S.CER C3216 JB 1C 106MT-N	B	16.4/95.5
C2062	4550007710	S.TAN TEESVB2 1A 476M8R	B	26.6/13
C2063	4030017730	S.CER ECJ0EB1E471K	B	46/13.7
C2064	4030018960	S.CER C3216 JB 1C 106MT-N	B	62.1/23
C2065	4030016930	S.CER ECJ0EB1A104K	B	73.3/1.2
C2066	4030016930	S.CER ECJ0EB1A104K	B	75.1/1.2
C2067	4030017430	S.CER ECJ0EC1H101J	B	55.3/25
C2068	4030017460	S.CER ECJ0EB1E102K	B	59.1/26.1
C2069	4030017330	S.CER ECJ0EB1E471K	B	44/12
C2101	4030017330	S.CER ECJ0EF1C104Z	T	28.3/114
C2102	4030017330	S.CER ECJ0EF1C104Z	T	44.7/110.9
C2103	4030018960	S.CER C3216 JB 1C 106MT-N	T	28.8/112.4
C2104	4030017330	S.CER ECJ0EF1C104Z	T	56.1/123.5
C2105	4030018960	S.CER C3216 JB 1C 106MT-N	T	54.7/125
C2156	4030017330	S.CER ECJ0EF1C104Z	T	36.2/122.1
C2157	4030017330	S.CER ECJ0EF1C104Z	B	34.4/91
C2158	4030017330	S.CER ECJ0EF1C104Z	B	27.4/93.7
C2159	4030017330	S.CER ECJ0EF1C104Z	T	22.4/94.4
C2160	4030017330	S.CER ECJ0EF1C104Z	B	38.2/88.8
C2161	4030018960	S.CER C3216 JB 1C 106MT-N	T	36.8/123.6
C2162	4030018960	S.CER C3216 JB 1C 106MT-N	B	37.7/90.4
C2163	4030017780	S.CER ECJ0EB1E472K	T	4.6/116.5
C2164	4030018960	S.CER C3216 JB 1C 106MT-N	T	6.5/114.9
C2166	4030012610	S.CER C2012 JB 1C 474K-T	T	5.2/106.8
C2167	4030018960	S.CER C3216 JB 1C 106MT-N	T	4.9/109.9
C2168	4030012610	S.CER C2012 JB 1C 474K-T	T	16.5/116.8

[MAIN UNIT]

REF NO.	ORDER NO.	DESCRIPTION	M.	H/V LOCATION
C2169	4030016930	S.CER ECJ0EB1A104K	T	13.6/124.4
C2201	4030017780	S.CER ECJ0EB1E472K	T	24.7/125.8
C2203	4030018520	S.CER C1608 JB 0J 225M-T	T	16/118.4
C2204	4030017330	S.CER ECJ0EF1C104Z	T	11.1/119.7
C2205	4030018960	S.CER C3216 JB 1C 106MT-N	T	12.4/117.1
C2206	4030017780	S.CER ECJ0EB1E472K	T	21.7/115.6
C2208	4030017730	S.CER ECJ0EB1E471K	T	19/116.9
C2211	4030018960	S.CER C3216 JB 1C 106MT-N	T	22.4/119.9
C2212	4030018960	S.CER C3216 JB 1C 106MT-N	T	23.2/124.3
C2213	4550007140	S.TAN TEESVD 1C 107M12R	T	37.4/139.1
C2214	4030018910	S.CER C1608 JB 0J 475K-T	T	20.9/122.6
C2231	4030017330	S.CER ECJ0EF1C104Z	T	38.2/105.6
C2232	4030018960	S.CER C3216 JB 1C 106MT-N	T	38.1/104
C2233	4030017780	S.CER ECJ0EB1E472K	T	4.7/123.2
C2234	4550007310	S.TAN F930J227MNMBA	T	70.1/130.6
C2235	4030018960	S.CER C3216 JB 1C 106MT-N	T	40.9/108.8
C2236	4030018960	S.CER C3216 JB 1C 106MT-N	T	39.8/111.1
C2237	4030017460	S.CER ECJ0EB1E102K	T	60.6/123.3
C2254	4030017330	S.CER ECJ0EF1C104Z	T	7.6/92.5
C2255	4030017330	S.CER ECJ0EF1C104Z	B	2.4/98.1
C2256	4030017330	S.CER ECJ0EF1C104Z	B	2.6/95.6
C2257	4030017330	S.CER ECJ0EF1C104Z	T	9.9/87.9
C2260	4030017330	S.CER ECJ0EF1C104Z	T	18.5/103.6
C2261	4030017330	S.CER ECJ0EF1C104Z	T	6.7/104.4
C2262	4030017330	S.CER ECJ0EF1C104Z	T	58.5/100.3
C2264	4030017330	S.CER ECJ0EF1C104Z	T	61.8/88.9
C2266	4030017330	S.CER ECJ0EF1C104Z	T	72/85.2
C2268	4030017330	S.CER ECJ0EF1C104Z	T	68.5/89.4
C2269	4030017330	S.CER ECJ0EF1C104Z	B	74.8/92.4
C2270	4030017780	S.CER ECJ0EB1E472K	T	61.8/89.8
C2272	4030017330	S.CER ECJ0EF1C104Z	T	56.2/92.2
C2274	4030017330	S.CER ECJ0EF1C104Z	T	55.8/95
C2275	4030017330	S.CER ECJ0EF1C104Z	B	68.1/99.3
C2276	4030017330	S.CER ECJ0EF1C104Z	B	64.2/100.6
C2277	4030017330	S.CER ECJ0EF1C104Z	T	63.6/103.4
C2278	4030017330	S.CER ECJ0EF1C104Z	T	63.6/107.9
C2279	4030017330	S.CER ECJ0EF1C104Z	T	62.7/108.8
C2280	4030017420	S.CER ECJ0EC1H470J	T	51.8/37.9
C2281	4030017330	S.CER ECJ0EF1C104Z	T	68.5/90.3
C2282	4030017330	S.CER ECJ0EF1C104Z	B	80.4/93
C2283	4030017330	S.CER ECJ0EF1C104Z	B	81.6/92.1
C2285	4030017330	S.CER ECJ0EF1C104Z	T	50.8/99
C2286	4030017330	S.CER ECJ0EF1C104Z	T	14.1/88.8
C2301	4030018910	S.CER C1608 JB 0J 475K-T	T	30.8/106.9
C2302	4030018910	S.CER C1608 JB 0J 475K-T	T	27.8/109.4
C2303	4550007310	S.TAN F930J227MNMBA	T	84.4/110.3
C2311	4030017330	S.CER ECJ0EF1C104Z	B	68.1/110.2
C2312	4030018910	S.CER C1608 JB 0J 475K-T	B	67.3/104.9
C2401	4030017330	S.CER ECJ0EF1C104Z	B	80.8/103.3
C2402	4030017330	S.CER ECJ0EF1C104Z	B	81.2/100.7
C2403	4030017780	S.CER ECJ0EB1E472K	B	77.2/28.8
C2405	4030017330	S.CER ECJ0EF1C104Z	T	74.2/79.3
C2406	4030017460	S.CER ECJ0EB1E102K	B	88.5/99.7
C2407	4030017330	S.CER ECJ0EF1C104Z	T	74.1/78.2
C2408	4030017330	S.CER ECJ0EF1C104Z	B	84.9/96.1
C2409	4030017330	S.CER ECJ0EF1C104Z	T	75.6/77.6
C2410	4030017330	S.CER ECJ0EF1C104Z	B	88.5/85.8
C2411	4030017330	S.CER ECJ0EF1C104Z	B	81.1/96.4
C2412	4510008630	S.ELE 16 CE 47 FE	B	62.1/30.4
C2413	4030017330	S.CER ECJ0EF1C104Z	B	88.5/93.7
C2414	4030017780	S.CER ECJ0EB1E472K	T	84/95.6
C2415	4030017780	S.CER ECJ0EB1E472K	B	88.3/28
C2417	4030017330	S.CER ECJ0EF1C104Z	B	88.3/27.1
C2418	4030017330	S.CER ECJ0EF1C104Z	B	82.6/94
C2419	4030017330	S.CER ECJ0EF1C104Z	B	88.5/86.7
C2422	4030017330	S.CER ECJ0EF1C104Z	T	84.8/87.3
C2423	4030017420	S.CER ECJ0EC1H470J	B	63.9/140.5
C2424	4510008630	S.ELE 16 CE 47 FE	B	69.2/31.3
C2426	4030017330	S.CER ECJ0EF1C104Z	B	68.8/82.1
C2427	4030012600	S.CER C2012 JB 1A 105M-T	T	85.1/91.4
C2501	4030017330	S.CER ECJ0EF1C104Z	B	8/94.2
C2502	4030018960	S.CER C3216 JB 1C 106MT-N	B	11.5/95.2
C2503	4030016970	S.CER ECJ0EB1C223K	B	14.9/89.3
C2505	4030016940	S.CER ECJ0EB1A393K	B	17.4/91.4
C2506	4030017780	S.CER ECJ0EB1E472K	B	18.2/93.8
C2507	4030017490	S.CER C1608 JB 1A 105K-T	B	12.7/89.2
C2551	4030017330	S.CER ECJ0EF1C104Z	B	42.9/124.1
C2552	4030018960	S.CER C3216 JB 1C 106MT-N	B	47.8/118.8
C2553	4030016970	S.CER ECJ0EB1C223K	B	51.3/124.7
C2554	4030018390	S.CER ECJ0EB1A563K	B	53.9/121.9
C2555	4030017760	S.CER ECJ0EB1H222K	B	53.9/121
C2556	4030017770	S.CER ECJ0EB1E332K	B	52.8/123.8
C2557	4030017330	S.CER ECJ0EF1C104Z	B	41.7/120.8
C2558	4030018960	S.CER C3216 JB 1C 106MT-N	B	42.9/118.8
C2561	4030018960	S.CER C3216 JB 1C 106MT-N	B	56.5/124.3
C2562	4030018960	S.CER C3216 JB 1C 106MT-N	B	52.8/126.6
C2563	4550007110	S.TAN SY6-1A107M-RC	B	75.3/122.8
C2564	4030018080	S.CER ECJ0EB1H182K	B	47.8/125.6
C2565	4030017430	S.CER ECJ0EC1H101J	B	44.6/122.6
C2566	4030018090	S.CER ECJ0EB1C822K	B	46.2/124.3
C2601	4030017330	S.CER ECJ0EF1C104Z	B	59.7/125.1

M.=Mounted side (T: Mounted on the Top side, B: Mounted on the Bottom side)
S.=Surface mount

[MAIN UNIT]

REF NO.	ORDER NO.	DESCRIPTION	M.	H/V LOCATION
C2603	4030010210	S.CER C3216 JB 1C 105M-T	B	87.5/126
C2604	4030016790	S.CER ECJ0EB1C103K	B	89.1/128.6
C2605	4030017330	S.CER ECJ0EF1C104Z	B	85.4/135
C2606	4510009250	S.ELE EEEFK1C471P	T	69.2/137.4
C2607	4510008650	S.ELE EEEFK1C221P	T	58.6/138.3
C2608	4030017330	S.CER ECJ0EF1C104Z	B	87.5/128.6
C2610	4510009250	S.ELE EEEFK1C471P	T	6.2/65.3
C2612	4030017330	S.CER ECJ0EF1C104Z	B	33.9/124.3
C2613	4510009250	S.ELE EEEFK1C471P	T	31.7/132.1
C2616	4030017780	S.CER ECJ0EB1E472K	B	30/134.2
C2617	4030017780	S.CER ECJ0EB1E472K	T	33.2/126
C2618	4030017430	S.CER ECJ0EC1H101J	B	30/133.1
C2619	4030017780	S.CER ECJ0EB1E472K	T	67.7/112.6
C2620	4510008630	S.ELE 16 CE 47 FE	B	82.9/119.1
C2621	4510008500	S.ELE EEE1CA101WP	T	49.3/138.3
C2622	4510008500	S.ELE EEE1CA101WP	T	60.1/130.4
C2624	4030017330	S.CER ECJ0EF1C104Z	B	38.4/125.1
CP1601	6910009670	S.CHK HK3-S-T	T	11.7/54.7
J1	6510007020	CNR TMP-J01X-V6		
J101	6510007020	CNR TMP-J01X-V6		
J401	6510007020	CNR TMP-J01X-V6		
J801	6510007020	CNR TMP-J01X-V6		
J2002	6510019971	S.CNR 52808-1071	T	39/12.6
J2003	6510024860	S.CNR 406721-2	T	18.7/137.8
J2004	6510023510	S.CNR 28FLT-SM1-TB	T	82.4/4.9
J2005	6510023510	S.CNR 28FLT-SM1-TB	T	66/4.9
J2231	6510018961	S.CNR B2B-PH-SM4-TB (LF) (SN)	T	51.6/129.5
J2251	6510022880	S.CNR AXK5S30340P	T	12.3/96.6
J2252	6510024820	S.CNR AXK5S60340P	T	72.4/101.1
J2401	6510024680	S.CNR HSJ1636-011020	B	57.7/137.1
J2402	6510024680	S.CNR HSJ1636-011020	B	47/137.1
J2403	6510019371	S.CNR B3B-ZR-SM4-TF (LF) (SN)	T	94.8/1.8
J2405	6510024880	S.CNR 52689-3087	T	90.3/93.8
J2406	6510024880	S.CNR 52689-3087	T	90.3/70.9
J2407	6510024680	S.CNR HSJ1636-011020	B	68.4/137.1
J2601	6510014961	S.CNR B2B-ZR-SM4-TF (LF) (SN)	T	42.6/128.8
J2602	6510024680	S.CNR HSJ1636-011020	B	36.3/137.1
W1	9029701008	WIR 72/98/020/X98/X98		
W601	9029701008	WIR 72/98/020/X98/X98		
EP104	6910012350	S.BEA MMZ1608Y 102BT	T	61.2/28.1
EP511	6910012350	S.BEA MMZ1608Y 102BT	T	44.1/26.5
EP1951	6910014730	S.BEA MPZ2012S331A-T	B	61.3/116.7
EP1952	6910014730	S.BEA MPZ2012S331A-T	B	26.8/113.3
EP1953	6910014730	S.BEA MPZ2012S331A-T	B	9.9/104.5
EP1954	6910014730	S.BEA MPZ2012S331A-T	B	50.3/107.3
EP2001	6910012350	S.BEA MMZ1608Y 102BT	B	74.2/5.3
EP2002	6910012350	S.BEA MMZ1608Y 102BT	B	34.7/12.6
EP2003	6910012350	S.BEA MMZ1608Y 102BT	B	33.5/13.8
EP2004	6910012350	S.BEA MMZ1608Y 102BT	B	39.5/15.9
EP2006	6910014730	S.BEA MPZ2012S331A-T	B	42.2/13.3
EP2007	6910012350	S.BEA MMZ1608Y 102BT	B	45.2/11.4
EP2008	6910012350	S.BEA MMZ1608Y 102BT	B	45.1/14.8
EP2231	6910012350	S.BEA MMZ1608Y 102BT	T	59.8/125.7
EP2251	6910012350	S.BEA MMZ1608Y 102BT	T	4.5/95.5
EP2252	6910012350	S.BEA MMZ1608Y 102BT	T	7.5/95.8
EP2253	6910012350	S.BEA MMZ1608Y 102BT	T	66.1/109.3
EP2254	6910012350	S.BEA MMZ1608Y 102BT	T	65.7/108.1
EP2255	6910012350	S.BEA MMZ1608Y 102BT	T	17.8/101.5
EP2256	6910012350	S.BEA MMZ1608Y 102BT	T	65.1/106
EP2257	6910012350	S.BEA MMZ1608Y 102BT	T	65.1/104.8
EP2258	6910012350	S.BEA MMZ1608Y 102BT	B	77.9/93.4
EP2259	6910012350	S.BEA MMZ1608Y 102BT	B	68.1/102.5
EP2260	6910012350	S.BEA MMZ1608Y 102BT	B	68.1/101.3
EP2261	6910012350	S.BEA MMZ1608Y 102BT	B	66/98.2
EP2262	6910012350	S.BEA MMZ1608Y 102BT	T	69.9/85.5
EP2263	6910014730	S.BEA MPZ2012S331A-T	T	6.5/93.9
EP2264	6910012350	S.BEA MMZ1608Y 102BT	B	69.3/111.3
EP2265	6910012350	S.BEA MMZ1608Y 102BT	B	66.8/98.2
EP2266	6910012350	S.BEA MMZ1608Y 102BT	T	58.2/93.3
EP2271	6910012350	S.BEA MMZ1608Y 102BT	T	74.6/91.1
EP2402	6910012350	S.BEA MMZ1608Y 102BT	B	50.4/130.2
EP2403	6910012350	S.BEA MMZ1608Y 102BT	B	47.8/130.2
EP2404	6910012350	S.BEA MMZ1608Y 102BT	B	67.2/130.2
EP2405	6910012350	S.BEA MMZ1608Y 102BT	B	52.6/135.9
EP2408	6910012350	S.BEA MMZ1608Y 102BT	B	91.3/102.2
EP2409	6910012350	S.BEA MMZ1608Y 102BT	T	85.3/101.2
EP2410	6910012350	S.BEA MMZ1608Y 102BT	T	84.7/98.3
EP2411	6910012350	S.BEA MMZ1608Y 102BT	T	85.2/79.2
EP2412	6910012350	S.BEA MMZ1608Y 102BT	T	82.5/78.4
EP2413	6910012350	S.BEA MMZ1608Y 102BT	B	71.5/130.1
EP2414	6910012350	S.BEA MMZ1608Y 102BT	B	89.3/91
EP2415	6910012350	S.BEA MMZ1608Y 102BT	T	84.9/100
EP2416	6910012350	S.BEA MMZ1608Y 102BT	T	80/77.6

[MAIN UNIT]

REF NO.	ORDER NO.	DESCRIPTION	M.	H/V LOCATION
EP2417	6910012350	S.BEA MMZ1608Y 102BT	B	87.2/78.8
EP2602	6910014730	S.BEA MPZ2012S331A-T	T	35.7/125.6
EP2604	6910014730	S.BEA MPZ2012S331A-T	B	29.8/135.6
EP2605	6910014730	S.BEA MPZ2012S331A-T	T	41.6/135.5
EP2606	6910014730	S.BEA MPZ2012S331A-T	T	40.9/133.8

[PA UNIT]

REF NO.	ORDER NO.	DESCRIPTION	M.	H/V LOCATION
IC471	1110005630	S.IC μPC3215TB-E3-A	B	67.5/96.4
IC701	1180002010	S.REG BA08FP-E2	B	126.3/41.9
IC960	1110002700	S.IC NJM2904M-TE1	B	41/132.1
IC981	1130012720	S.IC CD74HC4094PWR	T	26.2/5.9
Q101	1560001091	S.FET 2SK2854 (T2L ICOM, F)	T	149.2/28.5
Q102	1560001241	S.FET RD01MUS1-T113	T	146/40.1
Q301	1560001391	FET RD70HHF1-101		
Q302	1560001391	FET RD70HHF1-101		
Q401	1560001401	FET RD60HUF1-101		
Q402	1590000680	S.TR DTC114EUA T106	B	88/133
Q403	1590000680	S.TR DTC114EUA T106	B	90.4/129.9
Q451	1580000691	S.FET 3SK291 (TE85L, F)	B	75.3/108.4
Q452	1590003520	S.TR BCR108T	B	67.5/115.8
Q453	1590003520	S.TR BCR108T	B	73.2/119.2
Q501	1560001191	FET RD70HVF1-121		
Q502	1590000680	S.TR DTC114EUA T106	T	87.7/107.5
Q503	1590000680	S.TR DTC114EUA T106	T	87.7/110
Q551	1580000691	S.FET 3SK291 (TE85L, F)	T	68.4/108.9
Q552	1590003520	S.TR BCR108T	T	63/110.1
Q700	1590003520	S.TR BCR108T	B	127/24.9
Q741	1590003520	S.TR BCR108T	B	80.1/11
Q742	1520000460	S.TR 2SB1132 T100 R	B	82.7/7.3
Q980	1590003520	S.TR BCR108T	T	51.3/84.6
Q981	1590003520	S.TR BCR108T	T	51.5/13.8
Q982	1590003520	S.TR BCR108T	T	53.8/97.3
Q983	1590003520	S.TR BCR108T	T	51.2/56.9
Q984	1590003520	S.TR BCR108T	T	51.6/97.2
Q985	1590003520	S.TR BCR108T	T	51.3/27.9
Q986	1590003520	S.TR BCR108T	T	51.3/71.4
Q987	1590003520	S.TR BCR108T	T	52.5/41.6
Q988	1590003530	S.TR BCR08PN	T	58.3/90.3
D101	1750000301	S.DIO 1SS302 (TE85R, F)	T	152.4/22.7
D102	1750000301	S.DIO 1SS302 (TE85R, F)	T	152.4/19.8
D151	1750000581	S.DIO 1SV307 (TPH3, F)	T	59.5/56.4
D152	1790001250	S.DIO MA2S111-(TX)	T	56.3/58.5
D301	1160000060	S.DIO DAN202U T106	T	105.1/80.8
D302	1160000060	S.DIO DAN202U T106	T	74.9/87.3
D401	1790001240	S.DIO MA2S728-(TX)	B	128/133.6
D402	1790001240	S.DIO MA2S728-(TX)	B	127.5/139.5
D403	1790001240	S.DIO MA2S728-(TX)	B	123.4/140.5
D404	1790001240	S.DIO MA2S728-(TX)	B	125.6/132.8
D406	1710001060	DIO XB15A407		
D407	1710001060	DIO XB15A407		
D408	1750000511	S.DIO UX9401F-STD/TR	B	97.7/136.4
D409	1750000511	S.DIO UX9401F-STD/TR	B	103.5/133
D410	1750000511	S.DIO UX9401F-STD/TR	B	104.7/130
D411	1790001250	S.DIO MA2S111-(TX)	B	94.2/129.2
D412	1160000070	S.DIO DAN202K T146	B	92/127
D451	1750000581	S.DIO 1SV307 (TPH3, F)	B	85.5/116.3
D452	1750000581	S.DIO 1SV307 (TPH3, F)	B	82.4/116
D453	1720000701	S.VCP 1SV305 (TPL3,F)	T	75.5/117.3
D454	1720000701	S.VCP 1SV305 (TPL3,F)	T	77.8/116.6
D455	1720000701	S.VCP 1SV305 (TPL3,F)	B	75.6/99.1
D456	1720000701	S.VCP 1SV305 (TPL3,F)	B	67.3/104.1
D461	1750000581	S.DIO 1SV307 (TPH3, F)	B	65/93.3
D462	1750000581	S.DIO 1SV307 (TPH3, F)	T	65.6/94.7
D501	1790000970	S.DIO MA729 (TX)	B	113.7/123.4
D502	1790000970	S.DIO MA729 (TX)	B	116.3/122.8
D503	1790000970	S.DIO MA729 (TX)	B	114.5/129.4
D504	1790000970	S.DIO MA729 (TX)	B	111/129.4
D506	1710001060	DIO XB15A407		
D507	1750000511	S.DIO UX9401F-STD/TR	B	92.1/117.4
D508	1750000511	S.DIO UX9401F-STD/TR	T	86.9/114.4
D509	1750000511	S.DIO UX9401F-STD/TR	T	81.9/120.3
D510	1710001060	DIO XB15A407		
D511	1750000581	S.DIO 1SV307 (TPH3, F)	B	95.4/112.2
D551	1750000581	S.DIO 1SV307 (TPH3, F)	T	74/116.7
D552	1750000581	S.DIO 1SV307 (TPH3, F)	T	72.2/116.7
D553	1750000610	S.VCP MA2SV0500L	T	67.2/118.5
D554	1750000610	S.VCP MA2SV0500L	T	69.6/117.8

M.=Mounted side (T: Mounted on the Top side, B: Mounted on the Bottom side)

S.=Surface mount

[PA UNIT]

REF NO.	ORDER NO.	DESCRIPTION	M.	H/V LOCATION
D555	1750000581	S.DIO 1SV307 (TPH3, F)	T	66.9/116.7
D556	1720000590	S.VCP MA357 (TX)	T	71.6/113.3
D557	1750000581	S.DIO 1SV307 (TPH3, F)	T	68.1/104.9
D558	1720000590	S.VCP MA357 (TX)	T	72.2/104.3
D559	1750000610	S.VCP MA2SV0500L	T	68.9/102.7
D560	1750000610	S.VCP MA2SV0500L	T	71.7/101.3
D701	1790000700	DIO DSA3A1		
D702	1790000700	DIO DSA3A1		
D703	1160000070	S.DIO DAN202K T146	B	127/22.1
D704	1790001240	S.DIO MA2S728-(TX)	B	87.9/113.9
D705	1160000070	S.DIO DAN202K T146	B	137.1/13.5
D706	1790001240	S.DIO MA2S728-(TX)	B	86/113
D801	1750000301	S.DIO 1SS302 (TE85R, F)	B	43/42
D820	1750000301	S.DIO 1SS302 (TE85R, F)	B	53.5/94.2
D840	1750000301	S.DIO 1SS302 (TE85R, F)	B	43.1/99.6
D860	1750000301	S.DIO 1SS302 (TE85R, F)	B	43/86
D880	1750000301	S.DIO 1SS302 (TE85R, F)	B	43/71.6
D900	1750000301	S.DIO 1SS302 (TE85R, F)	B	43.7/56.9
D920	1750000301	S.DIO 1SS302 (TE85R, F)	B	43/27.4
D940	1750000301	S.DIO 1SS302 (TE85R, F)	B	41.1/14.6
D961	1790000491	S.DIO HSM88ASTR-E	B	28.1/130.2
D962	1790000491	S.DIO HSM88ASTR-E	B	28.1/133.7
D964	1750000511	S.DIO UX9401F-STD/TR	B	40.1/43.9
D965	1750000511	S.DIO UX9401F-STD/TR	B	42.8/48
L101	6200005051	S.COL NLV25T-330J	T	151.3/33.6
L102	6200008570	S.COL LQW2BHN6N8D03L	T	152.3/37.3
L103	6180000990	COL LAL 04NA 101K		
L104	6180000990	COL LAL 04NA 101K		
L105	6200003950	S.COL HF50ACC 3225513-T	B	135.7/34.1
L107	6200002631	S.COL NLV25T-R10J	T	141/47.9
L108	6200003031	S.COL NLV32T-R47J	B	138/41.7
L151	6200003941	S.COL NLV25T-5R6J	B	64.1/41
L152	6200005521	S.COL NLV25T-470J	B	64.8/38
L201	6140004580	S.COL LR-515	T	150.4/52.5
L203	6200010040	S.COL AS100340-10N	T	113.8/79.5
L204	6200010040	S.COL AS100340-10N	T	123.5/69.7
L301	6140003410	COL LR-383		
L302	2040000490	COL EXC-ELDR25C		
L303	6140003590	COL LR-400 (TR10X5X5 6H3)		
L304	6140004570	COL LR-507		
L305	6140004560	COL LR-506		
L404	6200010060	S.COL AS080647-56N	T	141/108.9
L407	6200010170	S.COL AS080447-33N	T	146.6/110.7
L408	2040000490	COL EXC-ELDR25C		
L409	2040000490	COL EXC-ELDR25C		
L410	6200010040	S.COL AS100340-10N	T	126.5/137.8
L411	6200010420	S.COL FHW1210HC 1R0JGT	T	118.3/136.7
L412	6200010160	S.COL AS080440-22N	T	104.4/134.4
L413	6200010150	S.COL AS080340-15N	T	88.2/139.5
L414	6200010150	S.COL AS080340-15N	T	81/133.5
L415	6200008330	S.COL 0.45-1.4-4TL 15N	T	99.2/134
L416	6200008360	S.COL 0.25-1.9-13TL	T	93.8/132.1
L417	6200007790	S.COL LQW2BHN15J03L	B	98.3/131.1
L441	6200010040	S.COL AS100340-10N	T	133.4/137.8
L451	6200005621	S.COL ELJRE 4N7ZFA	B	81.5/120.1
L452	6200008530	S.COL 0.30-1.0-4TR 12N	T	76.7/114.9
L453	6200007230	S.COL LQW2BHN15NJ03L	B	73.8/104
L454	6200007230	S.COL LQW2BHN15NJ03L	B	69.9/102.3
L501	6200010780	S.COL C2520C-1ROG-A	T	117.1/86.6
L502	6200010060	S.COL AS080647-56N	T	118.1/125
L504	6200010780	S.COL C2520C-1ROG-A	T	105.7/123.4
L505	6200010070	S.COL AS080747-68N	T	90.2/118.5
L506	6200010170	S.COL AS080447-33N	T	91.9/124.3
L507	6200008170	S.COL 0.35-1.6-8TL 54N	T	84.7/118
L508	6200010050	S.COL AS080547-40N	T	81.8/127.7
L509	6200010780	S.COL C2520C-1ROG-A	T	93.2/113.1
L510	6200010050	S.COL AS080547-47N	T	75.5/127.5
L531	6110003980	COL LA-604		
L541	6200010070	S.COL AS080747-68N	T	128.5/129.8
L551	6200007700	S.COL LQW2BHN22NJ03L	T	76.1/120.8
L552	6200007720	S.COL LQW2BHN33NJ03L	T	70.8/121.2
L553	6200008090	S.COL LQW2BHN68NJ03L	T	65.1/121.6
L554	6200003640	S.COL MLF1608E 100K-T	T	64.9/114.8
L555	6200003711	S.COL NLV25T-2R7J	T	65.2/105.4
L556	6200003640	S.COL MLF1608E 100K-T	B	65.5/106.1
L557	6200007760	S.COL LQW2BHN82NJ03L	T	66.8/100.5
L558	6200007710	S.COL LQW2BHN27NJ03L	T	69.9/98.3
L560	6200002611	S.COL NLV25T-R47J	T	62.9/97.3
L601	6200010040	S.COL AS100340-10N	T	69.2/127.5
L602	6200010160	S.COL AS080440-22N	T	65.7/132.8
L603	6200010150	S.COL AS080340-15N	T	60.8/133.5
L705	6200003550	S.COL MLF1608A 4R7K-T	B	68.2/10.3
L706	6200011300	S.COL EXCML16A 270U	T	91/6.9
L707	6200011300	S.COL EXCML16A 270U	T	91/5.6
L801	6200011410	S.COL C2520C-82NG-A	T	55.8/55.5
L802	6200010650	S.COL C2520C-R12G-A	T	58.5/52.1
L803	6200007420	S.COL ELJFC 101K-F	B	50.4/39.8
L820	6200006430	S.COL ELJFC 180K-F	B	53.5/97.3
L821	6140002020	COL LR-229 (T50-10)		

[PA UNIT]

REF NO.	ORDER NO.	DESCRIPTION	M.	H/V LOCATION
L822	6140003540	COL LR-396		
L823	6200006430	S.COL ELJFC 180K-F	B	2.7/106.8
L840	6200007420	S.COL ELJFC 101K-F	B	50.1/98.6
L841	6140001820	COL LR-218 (T50-10)		
L842	6140001800	COL LR-216 (T50-2)		
L843	6140001800	COL LR-216 (T50-2)		
L844	6200007420	S.COL ELJFC 101K-F	B	2.6/90.7
L860	6200004440	S.COL ELJFC 4R7M-F	B	50.3/83.8
L861	6110003550	COL LA-547 (LA-214A)		
L862	6110003570	COL LA-550		
L863	6110003540	COL LA-548 (LA-215A)		
L864	6200004440	S.COL ELJFC 4R7M-F	B	2.8/74.5
L880	6200007420	S.COL ELJFC 101K-F	B	50.3/69.1
L881	6140002570	COL LR-294 (T50-2)		
L882	6140002580	COL LR-295 (T50-2)		
L883	6200007420	S.COL ELJFC 101K-F	B	2.6/58.4
L900	6200008600	S.COL ELJFC 560K-F	B	50/54.6
L901	6140002560	COL LR-293 (T50-10)		
L902	6140002560	COL LR-293 (T50-10)		
L903	6140002560	COL LR-293 (T50-10)		
L904	6200008600	S.COL ELJFC 560K-F	B	2.6/42.3
L920	6200007420	S.COL ELJFC 101K-F	B	50.4/25.4
L921	6140001780	COL LR-214 (T50-2)		
L922	6140001780	COL LR-214 (T50-2)		
L923	6200007420	S.COL ELJFC 101K-F	B	2.6/26.1
L940	6200007390	S.COL ELJFC 120K-F	B	47.3/9.9
L941	6140003450	COL LR-387 (T50-10)		
L942	6140003460	COL LR-388 (T50-10)		
L943	6200007420	S.COL ELJFC 101K-F	B	41.1/11.1
L944	6200007390	S.COL ELJFC 120K-F	B	9/10.5
L960	6200007420	S.COL ELJFC 101K-F	B	45.3/130.6
L961	6140003490	COL LR-391 (TR10X5X5 3A6)		
L980	6200007420	S.COL ELJFC 101K-F	B	30.7/8
L981	6200007420	S.COL ELJFC 101K-F	T	51.7/9
L982	6200007420	S.COL ELJFC 101K-F	T	48.3/2.3
R101	7030003370	S.RES ERJ3GEYJ 271 V (270 Ω)	B	150.9/21
R102	7030003230	S.RES ERJ3GEYJ 180 V (18 Ω)	B	150.9/22.5
R103	7030003370	S.RES ERJ3GEYJ 271 V (270 Ω)	B	151.9/25.2
R104	7030003300	S.RES ERJ3GEYJ 680 V (68 Ω)	B	150.8/27.7
R105	7030003420	S.RES ERJ3GEYJ 681 V (680 Ω)	T	152.7/29.8
R106	7030003480	S.RES ERJ3GEYJ 222 V (2.2 kΩ)	B	147.8/29.7
R107	7030003530	S.RES ERJ3GEYJ 562 V (5.6 kΩ)	B	147.8/28.3
R108	7030003400	S.RES ERJ3GEYJ 471 V (470 Ω)	T	151.4/31.7
R109	7030008190	S.RES ERJ12YJ330U (33 Ω)	B	145.5/32.7
R110	7030000230	S.RES MCR10EZJH 56 Ω	T	149.4/39.8
R111	7030003410	S.RES ERJ3GEYJ 561 V (560 Ω)	B	143.8/41.1
R112	7030003510	S.RES ERJ3GEYJ 392 V (3.9 kΩ)	B	146.1/37.5
R113	7030003540	S.RES ERJ3GEYJ 682 V (6.8 kΩ)	B	146.1/35.7
R116	7030000340	S.RES MCR10EZJH 470 Ω	B	141.3/40.8
R117	7030003860	S.RES ERJ3GE JPW V	T	146.7/47.7
R151	7030003380	S.RES ERJ3GEYJ 331 V (330 Ω)	B	61.6/37.8
R152	7030003440	S.RES ERJ3GEYJ 102 V (1 kΩ)	B	61.7/60.1
R153	7030003520	S.RES ERJ3GEYJ 472 V (4.7 kΩ)	T	59.2/57.9
R201	7030003320	S.RES ERJ3GEYJ 101 V (100 Ω)	B	123/49.9
R202	7030003520	S.RES ERJ3GEYJ 472 V (4.7 kΩ)	B	135.2/50.6
R204	7030003440	S.RES ERJ3GEYJ 102 V (1 kΩ)	B	138/52.8
R205	7030010420	S.RES ERJ1TYJ 560U (56 Ω)	B	145/51.5
R301	7030009300	S.RES ERJ1WY0R00U	B	92.2/84.4
R302	7030010520	S.RES ERJ1TYJ 101U (100 Ω)	T	89.4/86.1
R303	7030009300	S.RES ERJ1WY0R00U	B	85.4/84.4
R304	7030003320	S.RES ERJ3GEYJ 101 V (100 Ω)	T	107.1/79.8
R305	7030010410	S.RES ERJ1TYJ 220U (22 Ω)	T	100.2/84.1
R306	7030003320	S.RES ERJ3GEYJ 101 V (100 Ω)	B	71.2/83.3
R307	7030010410	S.RES ERJ1TYJ 220U (22 Ω)	T	77.5/84.1
R308	7030003480	S.RES ERJ3GEYJ 222 V (2.2 kΩ)	B	98.3/85.7
R309	7030003480	S.RES ERJ3GEYJ 222 V (2.2 kΩ)	B	79.5/85.7
R310	7030007630	S.RES MCR100ZJHJ 0.68 Ω	B	100.1/82.2
R311	7030007630	S.RES MCR100ZJHJ 0.68 Ω	B	78.3/82.1
R312	7030011250	S.RES ERJ1TY 390U (39 Ω)	T	100.9/77.7
R313	7030010540	S.RES ERJ1TYJ 330U (33 Ω)	T	97.2/77.7
R314	7030010540	S.RES ERJ1TYJ 330U (33 Ω)	T	81.6/77.7
R315	7030011250	S.RES ERJ1TY 390U (39 Ω)	T	77.9/77.7
R317	7030010950	S.RES ERJ1TYJ 100U (10 Ω)	B	104/20.6
R318	7030010950	S.RES ERJ1TYJ 100U (10 Ω)	B	99.6/20.6
R319	7030010660	S.RES ERJ1TYJ 6R8U (6.8 Ω)	B	89.4/54.5
R402	7030003320	S.RES ERJ3GEYJ 101 V (100 Ω)	B	151.7/73.1
R403	7030003520	S.RES ERJ3GEYJ 472 V (4.7 kΩ)	T	151.8/71.2
R404	7030000260	S.RES MCR10EZJH 100 Ω	T	149.4/76
R405	7030003540	S.RES ERJ3GEYJ 682 V (6.8 kΩ)	B	126.7/137.5
R406	7030003860	S.RES ERJ3GE JPW V	B	128.4/136.1
R407	7030003440	S.RES ERJ3GEYJ 102 V (1 kΩ)	B	129.7/133.6
R408	7030003860	S.RES ERJ3GE JPW V	B	124.1/137.6
R409	7030003440	S.RES ERJ3GEYJ 102 V (1 kΩ)	B	127/130.4
R410	7030003440	S.RES ERJ3GEYJ 102 V (1 kΩ)	B	131.6/133
R411	7030003540	S.RES ERJ3GEYJ 682 V (6.8 kΩ)	B	125.1/135.5
R412	7030003500	S.RES ERJ3GEYJ 332 V (3.3 kΩ)	B	131.1/129.7
R413	7030007160	S.RES ERJ12YJ3R3U (3.3 Ω)	B	123.5/125.1
R415	7030008350	S.RES ERJ12YJ390U	B	86.7/136.4
R416	7030000140	S.RES MCR10EZJH 10 Ω	B	94.6/130.7

M.=Mounted side (T: Mounted on the Top side, B: Mounted on the Bottom side)
S.=Surface mount

[PA UNIT]

REF NO.	ORDER NO.	DESCRIPTION	M.	H/V LOCATION
R417	7030000140	S.RES MCR10EZHZ 10 Ω	B	95.5/132.5
R418	7030000010	S.RES MCR10EZHZ JPW	B	99.3/133.9
R451	7030003470	S.RES ERJ3GEYJ 182 V (1.8 kΩ)	B	81.5/121.7
R452	7030004040	S.RES ERJ3GEYJ 4R7 V (4.7 Ω)	B	85.5/119.3
R453	7030003260	S.RES ERJ3GEYJ 330 V (33 Ω)	B	81.6/118.4
R454	7030003860	S.RES ERJ3GE JPW V	B	77.3/116
R455	7030003640	S.RES ERJ3GEYJ 473 V (47 kΩ)	B	73.2/117.5
R456	7030003700	S.RES ERJ3GEYJ 154 V (150 kΩ)	B	72/114.4
R457	7030003750	S.RES ERJ3GEYJ 394 V (390 kΩ)	B	71.2/111.9
R458	7030003710	S.RES ERJ3GEYJ 184 V (180 kΩ)	B	73.8/112.4
R459	7030003740	S.RES ERJ3GEYJ 334 V (330 kΩ)	B	69.6/111.3
R460	7030003740	S.RES ERJ3GEYJ 334 V (330 kΩ)	B	76.6/112.1
R461	7030003270	S.RES ERJ3GEYJ 390 V (39 Ω)	B	77.7/103.3
R462	7030003680	S.RES ERJ3GEYJ 104 V (100 kΩ)	B	72.9/99.6
R463	7030003520	S.RES ERJ3GEYJ 472 V (4.7 kΩ)	B	74.4/102.4
R464	7030003210	S.RES ERJ3GEYJ 120 V (12 Ω)	B	74.2/105.7
R465	7030003680	S.RES ERJ3GEYJ 104 V (100 kΩ)	B	66.5/101.7
R466	7030003860	S.RES ERJ3GE JPW V	B	62.1/100.2
R467	7030003640	S.RES ERJ3GEYJ 473 V (47 kΩ)	B	75/118.9
R468	7030008240	S.RES ERJ12YJ0R00U	B	89.1/121.9
R470	7030003320	S.RES ERJ3GEYJ 101 V (100 Ω)	B	67.7/98.8
R471	7030003270	S.RES ERJ3GEYJ 390 V (39 Ω)	B	69.6/98.3
R472	7030003340	S.RES ERJ3GEYJ 151 V (150 Ω)	B	69.6/99.5
R473	7030003340	S.RES ERJ3GEYJ 151 V (150 Ω)	B	69.6/100.7
R474	7030003340	S.RES ERJ3GEYJ 151 V (150 Ω)	B	63.5/96.9
R475	7030003340	S.RES ERJ3GEYJ 151 V (150 Ω)	B	64.9/96.7
R476	7030003270	S.RES ERJ3GEYJ 390 V (39 Ω)	B	64.8/94.9
R477	7030003360	S.RES ERJ3GEYJ 221 V (220 Ω)	B	61.8/97.6
R502	7030003320	S.RES ERJ3GEYJ 101 V (100 Ω)	T	112.1/87.9
R503	7030003520	S.RES ERJ3GEYJ 472 V (4.7 kΩ)	T	112.6/86
R504	7030000260	S.RES MCR10EZHZ 100 Ω	T	114.2/86.2
R505	7030003540	S.RES ERJ3GEYJ 682 V (6.8 kΩ)	B	119.9/124.8
R507	7030003440	S.RES ERJ3GEYJ 102 V (1 kΩ)	B	110.2/123.1
R508	7030003520	S.RES ERJ3GEYJ 472 V (4.7 kΩ)	B	107.1/121.9
R510	7030003440	S.RES ERJ3GEYJ 102 V (1 kΩ)	B	110.3/125.7
R511	7030003540	S.RES ERJ3GEYJ 682 V (6.8 kΩ)	B	112.1/133.9
R512	7030003560	S.RES ERJ3GEYJ 103 V (10 kΩ)	B	107.1/123.1
R513	7030010520	S.RES ERJ1TYJ 101U (100 Ω)	B	103.7/114.2
R515	7030006060	S.RES ERJ12YJ100U (10 Ω)	T	92.1/108.9
R516	7030003860	S.RES ERJ3GE JPW V	T	90.6/113.6
R517	7030010520	S.RES ERJ1TYJ 101U (100 Ω)	B	103.7/118.4
R518	7030003440	S.RES ERJ3GEYJ 102 V (1 kΩ)	B	97.5/112.7
R519	7030000010	S.RES MCR10EZHZ JPW	B	111.1/119.5
R551	7030003470	S.RES ERJ3GEYJ 182 V (1.8 kΩ)	T	78.2/117.8
R552	7030004040	S.RES ERJ3GEYJ 4R7 V (4.7 Ω)	T	76.7/119.1
R553	7030003260	S.RES ERJ3GEYJ 330 V (33 Ω)	T	73/118.9
R554	7030003680	S.RES ERJ3GEYJ 104 V (100 kΩ)	T	66.8/120.4
R555	7030003440	S.RES ERJ3GEYJ 102 V (1 kΩ)	T	68.1/114.7
R556	7030003680	S.RES ERJ3GEYJ 104 V (100 kΩ)	T	69.9/116.6
R557	7030003740	S.RES ERJ3GEYJ 334 V (330 kΩ)	T	65.7/112.9
R558	7030003710	S.RES ERJ3GEYJ 184 V (180 kΩ)	T	70.5/111.2
R559	7030003720	S.RES ERJ3GEYJ 224 V (220 kΩ)	T	65.7/111.7
R560	7030003270	S.RES ERJ3GEYJ 224 V (220 kΩ)	T	65.6/110.5
R561	7030003740	S.RES ERJ3GEYJ 334 V (330 kΩ)	T	68.3/112.4
R562	7030003270	S.RES ERJ3GEYJ 390 V (39 Ω)	T	70.1/106.6
R563	7030003420	S.RES ERJ3GEYJ 681 V (680 Ω)	T	65.4/107.3
R564	7030003210	S.RES ERJ3GEYJ 120 V (12 Ω)	T	63.5/103
R565	7030003440	S.RES ERJ3GEYJ 102 V (1 kΩ)	B	65.8/108.1
R567	7030003680	S.RES ERJ3GEYJ 104 V (100 kΩ)	T	70.1/104
R568	7030003680	S.RES ERJ3GEYJ 104 V (100 kΩ)	T	69.7/100.7
R570	7030003380	S.RES ERJ3GEYJ 331 V (330 Ω)	T	62.8/100.3
R575	7030003520	S.RES ERJ3GEYJ 472 V (4.7 kΩ)	T	68.4/100.7
R576	7030003540	S.RES ERJ3GEYJ 682 V (6.8 kΩ)	T	71.8/100
R577	7030003520	S.RES ERJ3GEYJ 472 V (4.7 kΩ)	T	68/120.4
R578	7030003540	S.RES ERJ3GEYJ 682 V (6.8 kΩ)	T	69.9/119
R701	7030003500	S.RES ERJ3GEYJ 332 V (3.3 kΩ)	B	82.2/16.9
R702	7030003500	S.RES ERJ3GEYJ 332 V (3.3 kΩ)	B	83/14.5
R703	7030003500	S.RES ERJ3GEYJ 332 V (3.3 kΩ)	B	80.6/16.9
R704	7030003500	S.RES ERJ3GEYJ 332 V (3.3 kΩ)	B	79.7/14.5
R705	7030009300	S.RES ERJ1WY0R00U	B	134.6/23.8
R721	7030011240	S.RES LRF3W-LF-01-R020F	B	83/22.3
R722	7030011240	S.RES LRF3W-LF-01-R020F	B	83/29.6
R723	7030004040	S.RES ERJ3GEYJ 4R7 V (4.7 Ω)	B	140.5/14.7
R733	7030009590	S.RES ERA3YED 472V (4.7 kΩ)	B	138.6/10.4
R734	7510001470	S.TMR NTCG20 4AG 473JT	T	111.9/58.2
R735	7030009591	S.RES ERA3YED 472V (4.7 kΩ)	B	140.2/12.5
R736	7030001470	S.TMR NTCG20 4AG 473JT	T	153.3/77.1
R742	7030003640	S.RES ERJ3GEYJ 473 V (47 kΩ)	B	86.4/6.5
R743	7030003440	S.RES ERJ3GEYJ 102 V (1 kΩ)	B	82.5/10.5
R744	7030003860	S.RES ERJ3GE JPW V	T	67.8/9.6
R749	7030003860	S.RES ERJ3GE JPW V	B	65/5.2
R750	7030003860	S.RES ERJ3GE JPW V	B	66.5/5.2
R773	7030003860	S.RES ERJ3GE JPW V	T	103.4/9.5
R960	7030003860	S.RES ERJ3GE JPW V	B	43.2/125.7
R961	7030003380	S.RES ERJ3GEYJ 331 V (330 Ω)	B	42/138.3
R962	7030003440	S.RES ERJ3GEYJ 102 V (1 kΩ)	B	37.4/137.8
R963	7030003440	S.RES ERJ3GEYJ 102 V (1 kΩ)	B	40.3/126.3
R964	7030003860	S.RES ERJ3GE JPW V	B	24.8/131.2
R965	7030003640	S.RES ERJ3GEYJ 473 V (47 kΩ)	B	32.6/130.5
R966	7030008190	S.RES ERJ12YJ330U (33 Ω)	B	11.1/129.6
R967	7030003640	S.RES ERJ3GEYJ 473 V (47 kΩ)	B	34.2/130.5

[PA UNIT]

REF NO.	ORDER NO.	DESCRIPTION	M.	H/V LOCATION
R968	7030003860	S.RES ERJ3GE JPW V	B	24.8/132.8
R969	7030003660	S.RES ERJ3GEYJ 223 V (22 kΩ)	B	32.6/133.6
R970	7030003680	S.RES ERJ3GEYJ 104 V (100 kΩ)	B	34.2/133.6
R971	7540000130	ABS 2P-50A-301		
R972	7030003620	S.RES ERJ3GEYJ 333 V (33 kΩ)	B	17.4/140.1
R973	7030003620	S.RES ERJ3GEYJ 333 V (33 kΩ)	B	18.9/138.5
R974	7030003620	S.RES ERJ3GEYJ 333 V (33 kΩ)	B	19.4/136.6
R994	7030003560	S.RES ERJ3GEYJ 104 V (10 kΩ)	B	22.4/2.6
R995	7030003560	S.RES ERJ3GEYJ 103 V (10 kΩ)	B	22.4/6.8
R996	7030003560	S.RES ERJ3GEYJ 103 V (10 kΩ)	B	21.6/5.4
R997	7030003560	S.RES ERJ3GEYJ 103 V (10 kΩ)	B	21.6/8.2
R998	7030003320	S.RES ERJ3GEYJ 101 V (100 Ω)	T	54.1/4.4
R999	7030003320	S.RES ERJ3GEYJ 101 V (100 Ω)	T	54.5/3.1
R1000	7030003320	S.RES ERJ3GEYJ 101 V (100 Ω)	T	51.2/3.5
R1001	7030003320	S.RES ERJ3GEYJ 101 V (100 Ω)	T	49.3/4.9
R1002	7030000280	S.RES MCR10EZHZ 150 Ω	T	48.8/7.9
R1003	7030000290	S.RES MCR10EZHZ 180 Ω	T	47.5/7.9
C101	4030011600	S.CER C1608 JB 1E 104K-T	T	151.9/25.1
C102	4030011600	S.CER C1608 JB 1E 104K-T	B	150.8/29.3
C103	4030011340	S.CER C1608 CH 1H 471J-T	T	152.7/27.2
C104	4030011600	S.CER C1608 JB 1E 104K-T	T	147.8/32.2
C105	4510004591	ELE 16 ME 470 HC		
C106	4030011600	S.CER C1608 JB 1E 104K-T	B	142.7/29.2
C107	4030011600	S.CER C1608 JB 1E 104K-T	T	151.6/39.7
C108	4030011600	S.CER C1608 JB 1E 104K-T	T	149.2/36.5
C109	4030007130	S.CER C1608 CH 1H 101J-T	B	146.6/42.1
C112	4030011600	S.CER C1608 JB 1E 104K-T	B	139.2/35.1
C113	4030011600	S.CER C1608 JB 1E 104K-T	T	144.6/44.4
C114	4030011600	S.CER C1608 JB 1E 104K-T	B	134.1/37
C116	4030007060	S.CER C1608 CH 1H 270J-T	T	144.6/45.8
C118	4030007130	S.CER C1608 CH 1H 101J-T	T	143.5/48.5
C119	4030007130	S.CER C1608 CH 1H 101J-T	T	144/50.4
C120	4030007020	S.CER C1608 CH 1H 102J-T	T	143.5/47.2
C122	4510008500	S.ELE EEE1CA101WP	T	121.5/11.2
C151	4030011600	S.CER C1608 JB 1E 104K-T	T	59.2/54.8
C152	4030006880	S.CER C1608 JB 1H 472K-T	B	61.6/36.2
C153	4030011600	S.CER C1608 JB 1E 104K-T	B	63.1/56
C154	4030006860	S.CER C1608 JB 1H 102K-T	B	63.1/54.7
C201	4030006860	S.CER C1608 JB 1H 102K-T	T	145.6/53
C202	4030006860	S.CER C1608 JB 1H 102K-T	T	143/53
C204	4030011600	S.CER C1608 JB 1E 104K-T	B	139.3/48.4
C205	4030006860	S.CER C1608 JB 1H 102K-T	B	123.3/48.6
C206	4030017810	S.CER C1608 CH 1H 102J-T	B	133.5/50.6
C207	4030017810	S.CER C1608 CH 1H 102J-T	B	139.3/49.7
C208	4030011600	S.CER C1608 JB 1E 104K-T	B	132/50.6
C209	4030007170	S.CER C1608 CH 1H 221J-T	B	139.3/51
C214	4030018940	S.CER GRM31A7U2J331JW31D	T	116.3/76.1
C215	4030018930	S.CER GRM31A7U2J221JW31D	T	122.2/73.9
C217	4030011600	S.CER C1608 JB 1E 104K-T	T	144.3/53.3
C218	4030018930	S.CER GRM31A7U2J221JW31D	T	101/88.5
C219	4030018930	S.CER GRM31A7U2J221JW31D	B	82.4/99.7
C251	4030011180	S.CER GRM31M2C2H220JV01L	B	134.9/66
C252	4030011180	S.CER GRM31M2C2H220JV01L	B	142.2/70.6
C253	4030011080	S.CER GRM31M2C2H6R0DV01L	B	145.5/79
C254	4030011160	S.CER GRM31M2C2H150JV01L	B	127.7/65.3
C261	4030012480	S.CER GRM31M2C2H121JV01L	B	131.7/75.1
C262	4030018940	S.CER GRM31A7U2J331JW31D	B	126/80.7
C263	4030018770	S.CER C3216 CH 2J 102J-T	B	122.1/80.7
C266	4030018950	S.CER GRM31A7U2J681JW31D	B	119.7/80.2
C267	4030018930	S.CER GRM31A7U2J221JW31D	B	124/85.3
C301	4030001100	S.CER GRM216B11H102KA01D	B	91.7/100.6
C302	40300011020	S.CER GRM216C21H121JA01D	B	93.8/100.6
C303	4030011600	S.CER C1608 JB 1E 104K-T	B	110.8/85.5
C304	4030017320	S.CER GRM21BB11H104KA11L	B	94.8/97.6
C305	4510004591	ELE 16 ME 470 HC		
C306	4030006860	S.CER C1608 JB 1H 102K-T	B	80/39.6
C307	4030006860	S.CER C1608 JB 1H 102K-T	B	98/39.5
C308	4030006860	S.CER C1608 JB 1H 102K-T	B	88/11.2
C309	4030011600	S.CER C1608 JB 1E 104K-T	T	105.8/78.3
C311	4030018750	S.CER C3225 CH 2J 682K-T	B	92.7/78.5
C312	4030018750	S.CER C3225 CH 2J 682K-T	B	84.9/78.5
C313	4030011600	S.CER C1608 JB 1E 104K-T	T	76.8/87.8
C314	4030018750	S.CER C3225 CH 2J 682K-T	B	96.9/77.5
C315	4030018750	S.CER C3225 CH 2J 682K-T	B	80.6/77.6
C319	4030011730	S.CER GRM31M2C2H101JV01L	B	110/48.8
C320	4030011730	S.CER GRM31M2C2H101JV01L	B	71.1/48.9
C323	4030003810	S.MIC UC342H 1200J-T	B	91.4/46.4
C324	4320001050	S.MIC UC342H 3900J-T	T	94.4/40.2
C325	4320001070	S.MIC UC342H 3300J-T	B	94.4/40.7
C327	4030011790	S.CER GRM55RF52A684ZD01L	T	65.9/46.3
C331	4030011600	S.CER C1608 JB 1E 104K-T	T	108.3/78.3
C332	4030011600	S.CER C1608 JB 1E 104K-T	B	69.5/81.4
C333	4030018940	S.CER GRM31A7U2J331JW31D	B	88.4/101.8
C340	4030006860	S.CER C1608 JB 1H 102K-T	B	80.2/107.1
C341	4030006860	S.CER C1608 JB 1H 102K-T	B	90.2/107.1
C342	4030006860	S.CER C1608 JB 1H 102K-T	B	85.2/91.9
C404	4030006860	S.C		

[PA UNIT]

REF NO.	ORDER NO.	DESCRIPTION	M.	H/V LOCATION
C408	4030018040	S.CER ERF22X 6C2H 180J D01L	B	134.2/93
C409	4030018040	S.CER ERF22X 6C2H 180J D01L	B	145.4/93
C410	4030018260	S.CER ERF22X 6C2H 150J D01L	B	145.4/96.4
C411	4030018260	S.CER ERF22X 6C2H 150J D01L	B	134.2/96.4
C412	4030018770	S.CER C3216 CH 2J 102J-T	T	136/111.5
C413	4030018770	S.CER C3216 CH 2J 102J-T	T	139.8/102.7
C415	4030018410	S.CER ERF22X 6C2H 2R0C D01L	T	143.1/139.4
C416	4030006880	S.CER C1608 JB 1H 472K-T	T	103.1/96.7
C417	4030018040	S.CER ERF22X 6C2H 180J D01L	T	139.2/136.2
C418	4030011120	S.CER GRM31M2C2H100JV01L	B	134.1/134.2
C419	4030011020	S.CER GRM31M4C2H1R0CY21L	B	132.6/138.2
C420	4030011080	S.CER GRM31M2C2H6R0DV01L	B	129.2/139.5
C421	4030011020	S.CER GRM31M4C2H1R0CY21L	B	120.6/136.8
C422	4030011120	S.CER GRM31M2C2H100JV01L	B	121.7/141.1
C423	4030007090	S.CER C1608 CH 1H 470J-T	B	127.8/131.7
C424	4030011090	S.CER GRM31M2C2H7R0DV01L	B	119/140.3
C425	4030011180	S.CER GRM31M2C2H20JV01L	T	121.6/137.4
C426	4030006860	S.CER C1608 JB 1H 102K-T	B	106.7/133.9
C427	4030011040	S.CER GRM31M4C2H2R0CY21L	B	102.6/139.6
C428	4030011090	S.CER GRM31M2C2H7R0DV01L	T	97/138.1
C429	4030017940	S.CER ERF22X 6C2H 680J D01L	T	92.3/136.9
C430	4030017190	S.CER GRM31AR32J471KW01D	B	92.7/136.5
C431	4030011070	S.CER GRM31M2C2H5R0CY21L	T	86.9/133.8
C432	4030004820	S.CER C2012 CH 1H 050C-T	B	99.2/139.3
C433	4030011090	S.CER GRM31M2C2H7R0DV01L	T	76.1/132.2
C434	4030006860	S.CER C1608 JB 1H 102K-T	B	90.1/125.4
C435	4030006860	S.CER C1608 JB 1H 102K-T	B	97.2/127.7
C436	4030006860	S.CER C1608 JB 1H 102K-T	T	98.4/130.9
C438	4030006850	S.CER C1608 JB 1H 471K-T	B	90.8/134
C439	4030006860	S.CER C1608 JB 1H 102K-T	B	92.8/133.1
C440	4030004710	S.CER C2012 JB 1H 471K-T	B	103.5/135.5
C441	4030011090	S.CER GRM31M2C2H7R0DV01L	T	137.6/140.4
C443	4030011020	S.CER GRM31M4C2H1R0CY21L	B	122.1/131
C452	4030007020	S.CER C1608 CH 1H 120J-T	B	87.3/119.3
C453	4030006860	S.CER C1608 JB 1H 102K-T	T	63.9/117.3
C456	4030009350	S.CER C1608 CH 1H 3R5B-T	B	78.2/118.4
C458	4030006860	S.CER C1608 JB 1H 102K-T	T	73.8/113.6
C461	4030011600	S.CER C1608 JB 1E 104K-T	B	68.8/113.3
C462	4030011600	S.CER C1608 JB 1E 104K-T	B	77.1/110.8
C463	4030006860	S.CER C1608 JB 1H 102K-T	B	78.1/109.4
C464	4030011600	S.CER C1608 JB 1E 104K-T	B	77.7/105.9
C465	4030011600	S.CER C1608 JB 1E 104K-T	B	68.9/108.9
C466	4030006860	S.CER C1608 JB 1H 102K-T	B	77.7/104.6
C467	4030006860	S.CER C1608 JB 1H 102K-T	B	68.9/107.6
C468	4030007020	S.CER C1608 CH 1H 120J-T	B	73.7/101.1
C470	4030011600	S.CER C1608 JB 1E 104K-T	B	77.7/101.7
C471	4030006860	S.CER C1608 JB 1H 102K-T	B	77.7/100.4
C472	4030009500	S.CER C1608 CH 1H 0R5B-T	B	69.7/105.2
C473	4030007040	S.CER C1608 CH 1H 180J-T	B	69.7/104
C474	4030009530	S.CER C1608 CH 1H 030B-T	B	67.7/101.7
C475	4030006860	S.CER C1608 JB 1H 102K-T	B	66.5/98.8
C476	4030006860	S.CER C1608 JB 1H 102K-T	B	68/111.3
C477	4030006860	S.CER C1608 JB 1H 102K-T	B	79.1/120.8
C478	4030006860	S.CER C1608 JB 1H 102K-T	B	58.1/119.3
C479	4030006860	S.CER C1608 JB 1H 102K-T	B	57.6/121.2
C480	4030007090	S.CER C1608 CH 1H 470J-T	B	63.4/100.8
C481	4030006860	S.CER C1608 JB 1H 102K-T	B	69.6/96.3
C482	4030006860	S.CER C1608 JB 1H 102K-T	B	67.9/94.5
C483	4030006860	S.CER C1608 JB 1H 102K-T	B	64.2/98.8
C484	4030007010	S.CER C1608 CH 1H 100D-T	B	71.5/106
C485	4030017810	S.CER C1608 CH 1H 102J-T	B	69.5/106
C501	4030006860	S.CER C1608 JB 1H 102K-T	T	109.3/87.9
C503	4030011070	S.CER GRM31M2C2H5R0CY21L	T	119.4/130.3
C504	4030017960	S.CER ERF22X 6C2H 330J D01L	T	111.8/122.1
C505	4030011040	S.CER GRM31M4C2H2R0CY21L	B	114.4/125.4
C506	4030011120	S.CER GRM31M2C2H100JV01L	B	118.2/125.6
C507	4030011040	S.CER GRM31M4C2H2R0CY21L	B	113.8/131.5
C508	4030011070	S.CER GRM31M2C2H5R0CY21L	B	110.4/132.8
C509	4030007150	S.CER C1608 CH 1H 151J-T	B	110.2/121.9
C511	4030018770	S.CER C3216 CH 2J 102J-T	T	109.6/125.4
C513	4030006860	S.CER C1608 JB 1H 102K-T	B	97.1/117.6
C514	4030011170	S.CER GRM31M2C2H180JV01L	T	98.4/118.1
C515	4030018770	S.CER C3216 CH 2J 102J-T	T	96.9/120.4
C516	4030011100	S.CER GRM31M2C2H8R0DV01L	T	88.2/124.1
C517	4030004880	S.CER C2012 CH 1H 120J-T	B	92.5/115.1
C518	4030018770	S.CER C3216 CH 2J 102J-T	B	94.1/121.4
C519	4030011190	S.CER GRM31M2C2H270JV01L	T	86.1/124.1
C520	4030004870	S.CER C2012 CH 1H 100D-T	B	934/112.5
C521	4030011290	S.CER GRM31M2C2H240JV01L	T	81.2/123.9
C522	4030006850	S.CER C1608 JB 1H 471K-T	T	96.3/107.7
C523	4030006860	S.CER C1608 JB 1H 102K-T	T	79.3/119.1
C524	4030006910	S.CER C1608 CH 1H 0R5C-T	T	79.9/120.9
C525	4030004720	S.CER C2012 JB 1H 102K-T	T	86.7/112.1
C526	4030007150	S.CER C1608 CH 1H 151J-T	B	113.3/121.9
C527	4030007150	S.CER C1608 CH 1H 151J-T	B	111.1/127.8
C528	4030006860	S.CER C1608 JB 1H 102K-T	B	96.2/114.5
C530	4030011230	S.CER GRM31M2C2H390JV01L	T	120.8/113.3
C531	4030018770	S.CER C3216 CH 2J 102J-T	B	106/109.3
C532	4030018770	S.CER C3216 CH 2J 102J-T	B	103.1/109.2
C534	4030018770	S.CER C3216 CH 2J 102J-T	T	118.6/107.9
C534	4030017880	S.CER ERF22X 6C2H 560J D01L	B	112.7/103.9

[PA UNIT]

REF NO.	ORDER NO.	DESCRIPTION	M.	H/V LOCATION
C535	4030017880	S.CER ERF22X 6C2H 560J D01L	B	124.1/103.9
C536	4030017980	S.CER ERF22X 6C2H 470J D01L	T	101/110.8
C537	4030017940	S.CER ERF22X 6C2H 680J D01L	T	101/114.2
C538	4030017880	S.CER ERF22X 6C2H 560J D01L	T	131.2/117.5
C541	4030011060	S.CER GRM31M2C2H4R0CY21L	T	125.1/123.7
C542	4030012480	S.CER GRM31M2C2H121JV01L	T	123.4/128.7
C544	4030011730	S.CER GRM31M2C2H101JV01L	T	129.9/123.5
C545	4030017940	S.CER ERF22X 6C2H 680J D01L	B	112.7/109.9
C551	4030006880	S.CER C1608 JB 1H 472K-T	T	80.1/117.1
C552	4030006860	S.CER C1608 JB 1H 102K-T	T	73/120.5
C553	4030006850	S.CER C1608 JB 1H 471K-T	T	69.4/114.7
C554	4030006860	S.CER C1608 JB 1H 102K-T	T	66.8/114.7
C555	4030006860	S.CER C1608 JB 1H 102K-T	T	63.1/111.7
C556	4030011600	S.CER C1608 JB 1E 104K-T	T	68.3/111.2
C557	4030006860	S.CER C1608 JB 1H 102K-T	T	70.8/108.5
C558	4030006860	S.CER C1608 JB 1H 102K-T	T	65.4/108.6
C559	4030006860	S.CER C1608 JB 1H 102K-T	T	66/103.5
C560	4030006860	S.CER C1608 JB 1H 102K-T	B	65.3/112.9
C561	4030006850	S.CER C1608 JB 1H 471K-T	T	70.1/105.3
C562	4030006860	S.CER C1608 JB 1H 102K-T	T	69.2/94.9
C563	4030006860	S.CER C1608 JB 1H 102K-T	T	62.3/106.1
C564	4030006860	S.CER C1608 JB 1H 102K-T	T	65/97
C565	4030006860	S.CER C1608 JB 1H 102K-T	T	62.3/103
C567	4030006860	S.CER C1608 JB 1H 102K-T	T	69.2/120.9
C601	4030011070	S.CER GRM31M2C2H5R0CY21L	T	69.5/132.7
C602	4030011090	S.CER GRM31M2C2H7R0DV01L	T	67/136.8
C701	4030017320	S.CER GRM21BB11H104KA11L	B	109.8/33.4
C702	4030006860	S.CER C1608 JB 1H 102K-T	B	107.7/33.2
C703	4030011600	S.CER C1608 JB 1E 104K-T	B	83.8/16.9
C704	4510004601	ELE 16 ME 1000 HC		
C705	4030011600	S.CER C1608 JB 1E 104K-T	B	79/16.9
C706	4510004601	ELE 16 ME 1000 HC		
C707	4030017320	S.CER GRM21BB11H104KA11L	B	67.1/18.6
C708	4030006900	S.CER C1608 JB 1H 103K-T	T	63.2/27.8
C709	4030006860	S.CER C1608 JB 1H 102K-T	T	62.3/26.5
C710	4030006850	S.CER C1608 JB 1H 471K-T	T	63.2/25.2
C711	4030007170	S.CER C1608 CH 1H 221J-T	T	63.2/23.9
C712	4030007170	S.CER C1608 CH 1H 221J-T	B	70.4/18.7
C713	4510004591	ELE 16 ME 470 HC		
C715	4030006860	S.CER C1608 JB 1H 102K-T	B	97.1/118.9
C718	4030011600	S.CER C1608 JB 1E 104K-T	B	128.4/19.3
C719	4030011600	S.CER C1608 JB 1E 104K-T	T	125.8/16.4
C720	4030011600	S.CER C1608 JB 1E 104K-T	B	130.5/38.7
C722	4030007130	S.CER C1608 CH 1H 101J-T	T	88.9/6.7
C723	4030007130	S.CER C1608 CH 1H 101J-T	T	78.3/3.1
C724	4030011340	S.CER C1608 CH 1H 471J-T	B	134.8/12.2
C725	4550007350	S.TAN F931C226MCMBMA	B	126.6/33.4
C726	4030006860	S.CER C1608 JB 1H 102K-T	B	91.3/11.1
C727	4030006860	S.CER C1608 JB 1H 102K-T	B	84.4/114.1
C728	4030006860	S.CER C1608 JB 1H 102K-T	B	91.2/112.6
C732	4030011600	S.CER C1608 JB 1E 104K-T	T	71.8/2.6
C733	4030011600	S.CER C1608 JB 1E 104K-T	T	66.8/12.9
C734	4030006860	S.CER C1608 JB 1H 102K-T	B	63.5/1.8
C735	4030011600	S.CER C1608 JB 1E 104K-T	T	74.1/13.2
C736	4030011600	S.CER C1608 JB 1E 104K-T	B	67.3/1.8
C737	4030011600	S.CER C1608 JB 1E 104K-T	B	65.4/1.8
C738	4030011600	S.CER C1608 JB 1E 104K-T	B	68.2/14.5
C739	4030011600	S.CER C1608 JB 1E 104K-T	B	69.8/14.5
C741	4030011600	S.CER C1608 JB 1E 104K-T	B	78.5/6.4
C742	4030011600	S.CER C1608 JB 1E 104K-T	T	69.4/12.9
C743	4030006860	S.CER C1608 JB 1H 102K-T	T	68.1/12.9
C744	4030011600	S.CER C1608 JB 1E 104K-T	T	70.7/12.9
C745	4030011600	S.CER C1608 JB 1E 104K-T	B	77.7/14.3
C746	4030011600	S.CER C1608 JB 1E 104K-T	B	76.2/15.1
C747	4030011600	S.CER C1608 JB 1E 104K-T	T	98.5/4.1
C749	4030011600	S.CER C1608 JB 1E 104K-T	T	96.6/6.4
C750	4030006880	S.CER C1608 JB 1H 472K-T	T	94.2/6.4
C751	4030006860	S.CER C1608 JB 1H 102K-T	T	95.4/6.4
C752	4030011600	S.CER C1608 JB 1E 104K-T	T	93/6.4
C753	4030006880	S.CER C1608 JB 1H 472K-T	B	59.9/10.7
C754	4030006860	S.CER C1608 JB 1H 102K-T	B	66.6/14.5
C757	4030011600	S.CER C1608 JB 1E 104K-T	B	76.4/8
C759	4030006880	S.CER C1608 JB 1H 472K-T	T	72.8/13.2
C760	4030006880	S.CER C1608 JB 1H 472K-T	B	74.8/8
C761	4030006880	S.CER C1608 JB 1H 472K-T	B	73.2/8
C762	4030006880	S.CER C1608 JB 1H 472K-T	B	70/8
C763	4030006880	S.CER C1608 JB 1H 472K-T	B	71.6/8
C764	4030006880	S.CER C1608 JB 1H 472K-T	B	61.9/1.8
C765	4030011600	S.CER C1608 JB 1E 104K-T	B	68.9/1.8
C766	4030006860	S.CER C1608 JB 1H 102K-T	B	66.5/8.7
C781	4030006860	S.CER C1608 JB 1H 102K-T	T	72.8/90.1
C782	4030006900	S.CER C1608 JB 1H 103K-T	T	71.8/84.3
C783	4030006880	S.CER C1608 JB 1H 472K-T	T	71.8/83.1

[PA UNIT]

REF NO.	ORDER NO.	DESCRIPTION	M.	H/V LOCATION
C820	4030011600	S.CER C1608 JB 1E 104K-T	B	54.1/91.2
C821	4030006880	S.CER C1608 JB 1H 472K-T	B	53.5/99.2
C822	4030011510	S.CER GRM31M2C2H560JV01L	B	42.2/21.9
C823	4030011160	S.CER GRM31M2C2H150JV01L	B	32.9/18.3
C824	4030012480	S.CER GRM31M2C2H121JV01L	B	25.1/17.1
C825	4030011240	S.CER GRM31M2C2H470JV01L	B	17.9/15.7
C826	4030011550	S.CER GRM31M2C2H680JV01L	B	11.2/19.9
C827	4030011510	S.CER GRM31M2C2H560JV01L	B	8.8/19.9
C828	4030006880	S.CER C1608 JB 1H 472K-T	T	5.2/106.7
C829	4030011600	S.CER C1608 JB 1E 104K-T	T	2.6/106.7
C830	4030011210	S.CER GRM31M2C2H330JV01L	B	22.4/17.1
C831	4030006880	S.CER C1608 JB 1H 472K-T	B	7.5/109.2
C832	4030006880	S.CER C1608 JB 1H 472K-T	B	51.5/95.4
C833	4030011730	S.CER GRM31M2C2H101JV01L	B	27.5/17.1
C835	4030012480	S.CER GRM31M2C2H121JV01L	B	16.6/107.1
C836	4030012480	S.CER GRM31M2C2H121JV01L	B	12.5/107.3
C837	4030012480	S.CER GRM31M2C2H121JV01L	B	12.5/105.2
C840	4030011600	S.CER C1608 JB 1E 104K-T	B	42.8/97.3
C841	4030006880	S.CER C1608 JB 1H 472K-T	B	47.9/8.5
C842	4030011730	S.CER GRM31M2C2H101JV01L	B	39/106.8
C843	4010008160	CER HM13SJ SL 431J 500V		
C844	4030011730	S.CER GRM31M2C2H101JV01L	B	25.9/102.9
C845	4030014460	S.CER GRM31M2C2H820JV01L	B	19.7/91.9
C846	4010005370	CER HM11SJ SL 331J 500V		
C847	4010005930	CER HM11SJ SL 391J 500V		
C848	4030011190	S.CER GRM31M2C2H270JV01L	B	11.4/98.7
C849	4030011180	S.CER GRM31M2C2H220JV01L	B	11.4/102.6
C850	4010005930	CER HM11SJ SL 391J 500V		
C851	4030012480	S.CER GRM31M2C2H121JV01L	B	20.2/112
C852	4030006880	S.CER C1608 JB 1H 472K-T	T	5.3/90.5
C853	4030011600	S.CER C1608 JB 1E 104K-T	T	2.6/90.5
C854	4030006880	S.CER C1608 JB 1H 472K-T	B	7.7/92.8
C855	4030011730	S.CER GRM31M2C2H101JV01L	B	27.9/104.9
C856	4030011510	S.CER GRM31M2C2H560JV01L	B	31.2/105.3
C857	4030012480	S.CER GRM31M2C2H121JV01L	B	43.1/108.5
C858	4030011730	S.CER GRM31M2C2H101JV01L	B	20.2/109.9
C860	4030011600	S.CER C1608 JB 1E 104K-T	B	43.4/83.8
C861	4030006880	S.CER C1608 JB 1H 472K-T	B	46.6/83.8
C863	4030011170	S.CER GRM31M2C2H180JV01L	B	37.5/93.5
C864	4030011510	S.CER GRM31M2C2H560JV01L	B	28.5/82.6
C865	4030011110	S.CER GRM31M2C2H9R0DV01L	B	29.4/78.6
C866	4030011230	S.CER GRM31M2C2H390JV01L	B	24.4/78
C867	4030011060	S.CER GRM31M2C2H4R0CY21L	B	17/71.9
C868	4030011240	S.CER GRM31M2C2H470JV01L	B	26.8/78.6
C869	4030011180	S.CER GRM31M2C2H220JV01L	B	8.7/83.5
C870	4030011170	S.CER GRM31M2C2H180JV01L	B	17/77.7
C871	4030006880	S.CER C1608 JB 1H 472K-T	T	5.2/74.4
C872	4030011600	S.CER C1608 JB 1E 104K-T	T	2.5/74.4
C873	4030011070	S.CER GRM31M2C2H5R0CY21L	B	33.2/92.6
C874	4030006880	S.CER C1608 JB 1H 472K-T	B	9/74.5
C876	4030011160	S.CER GRM31M2C2H150JV01L	B	22/77.4
C880	4030011600	S.CER C1608 JB 1E 104K-T	B	43.4/69.1
C881	4030006880	S.CER C1608 JB 1H 472K-T	B	47/69.1
C882	4010007590	CER HM15SJ SL 681J 500V		
C883	4010007590	CER HM15SJ SL 681J 500V		
C884	4010005930	CER HM11SJ SL 391J 500V		
C885	4320000981	DMI KD20C 22J5A		
C886	4030012480	S.CER GRM31M2C2H121JV01L	B	31.5/57.2
C887	4030011730	S.CER GRM31M2C2H101JV01L	B	33.9/57.2
C889	4030014460	S.CER GRM31M2C2H820JV01L	B	18/65.3
C890	4320001200	DIP KD19C 16J5A		
C893	4030006880	S.CER C1608 JB 1H 472K-T	T	5.3/58.3
C894	4030011600	S.CER C1608 JB 1E 104K-T	T	2.6/58.3
C900	4030011600	S.CER C1608 JB 1E 104K-T	B	44/54.4
C901	4030006880	S.CER C1608 JB 1H 472K-T	B	46.8/54.4
C902	4010005870	CER HM95SJ SL 221J 500V		
C903	4030011190	S.CER GRM31M2C2H270JV01L	B	30.9/42.7
C904	4030014460	S.CER GRM31M2C2H820JV01L	B	28.4/42.7
C905	4010005870	CER HM95SJ SL 221J 500V		
C906	4030011510	S.CER GRM31M2C2H560JV01L	B	17/44
C907	4030011510	S.CER GRM31M2C2H560JV01L	B	10.8/49.5
C908	4030006880	S.CER C1608 JB 1H 472K-T	T	5.3/42.1
C909	4030011600	S.CER C1608 JB 1E 104K-T	T	2.6/42.1
C920	4030011600	S.CER C1608 JB 1E 104K-T	B	43.2/25.1
C921	4030006880	S.CER C1608 JB 1H 472K-T	B	47.1/25.4
C922	4010007590	CER HM15SJ SL 681J 500V		
C923	4030011730	S.CER GRM31M2C2H101JV01L	B	31.4/27.3
C924	4010006410	CER HM13SJ SL 471J 500V		
C925	4030014460	S.CER GRM31M2C2H820JV01L	B	15.7/29.5
C926	4010006410	CER HM13SJ SL 471J 500V		
C927	4010005930	CER HM11SJ SL 391J 500V		
C928	4010005930	CER HM11SJ SL 391J 500V		
C929	4030006880	S.CER C1608 JB 1H 472K-T	T	5.3/25.8
C930	4030011600	S.CER C1608 JB 1E 104K-T	T	2.6/25.8
C931	4030014460	S.CER GRM31M2C2H820JV01L	B	34.1/27.3
C932	4030011730	S.CER GRM31M2C2H101JV01L	B	33.3/32.4
C933	4030011730	S.CER GRM31M2C2H101JV01L	B	29.7/30.9
C940	4030011600	S.CER C1608 JB 1E 104K-T	B	43.6/11.1
C941	4030006880	S.CER C1608 JB 1H 472K-T	B	43.6/14.2
C942	4030014460	S.CER GRM31M2C2H820JV01L	B	39.5/119.2
C943	4030011230	S.CER GRM31M2C2H390JV01L	B	28.9/111.7

[PA UNIT]

REF NO.	ORDER NO.	DESCRIPTION	M.	H/V LOCATION
C944	4030014460	S.CER GRM31M2C2H820JV01L	B	24.7/118.4
C945	4030011160	S.CER GRM31M2C2H150JV01L	B	16.5/118.1
C947	4030006880	S.CER C1608 JB 1H 472K-T	T	5.3/9.9
C948	4030011600	S.CER C1608 JB 1E 104K-T	T	2.6/9.9
C949	4030011050	S.CER GRM31M3C2H3R0CY21L	B	28.9/109.6
C960	4030010760	S.CER C1608 CH 1H 331J-T	T	18.1/130.2
C961	4030011600	S.CER C1608 JB 1E 104K-T	B	45.1/134.1
C962	4030006880	S.CER C1608 JB 1H 472K-T	B	39/137.8
C963	4030006880	S.CER C1608 JB 1H 472K-T	B	38.7/126.3
C964	4610002120	S.TRI T2B4Z100EB10R00	T	3.3/126.6
C966	4030006880	S.CER C1608 JB 1H 472K-T	B	21.2/131.2
C968	4030011340	S.CER C1608 CH 1H 471J-T	B	31/130.5
C969	4030011340	S.CER C1608 CH 1H 471J-T	B	31/133.6
C970	4030010760	S.CER C1608 CH 1H 331J-T	B	22/132.8
C971	4030011340	S.CER C1608 CH 1H 471J-T	B	35.8/133.6
C972	4030011790	S.CER GRM55RF52A684ZD01L	B	3.4/136.4
C973	4030007090	S.CER C1608 CH 1H 470J-T	B	8.3/129.8
C979	4030006880	S.CER C1608 JB 1H 472K-T	T	51.8/38.6
C987	4030006880	S.CER C1608 JB 1H 472K-T	B	28.9/3.3
C988	4030006880	S.CER C1608 JB 1H 472K-T	B	26.3/3.3
C989	4030006880	S.CER C1608 JB 1H 472K-T	B	25/2.6
C990	4030006880	S.CER C1608 JB 1H 472K-T	T	20.6/3
C991	4030006880	S.CER C1608 JB 1H 472K-T	T	20.6/4.2
C992	4030006880	S.CER C1608 JB 1H 472K-T	T	20.6/5.8
C993	4030006880	S.CER C1608 JB 1H 472K-T	T	20.6/6.6
C994	4030011600	S.CER C1608 JB 1E 104K-T	B	29.5/6.1
C995	4030006880	S.CER C1608 JB 1H 472K-T	B	23.7/3.4
C996	4030007090	S.CER C1608 CH 1H 470J-T	T	20.6/9
C997	4030007090	S.CER C1608 CH 1H 470J-T	T	20.6/7.8
C998	4030007090	S.CER C1608 CH 1H 470J-T	T	20.6/10.2
C999	4030006880	S.CER C1608 JB 1H 102K-T	T	56.8/9.5
C1000	4030006860	S.CER C1608 JB 1H 102K-T	B	55.5/5
C1001	4030011600	S.CER C1608 JB 1E 104K-T	B	51.6/1.7
C1002	4030006880	S.CER C1608 JB 1H 472K-T	B	27.6/2.6
C1003	4030011600	S.CER C1608 JB 1E 104K-T	T	49.8/7.6
C1004	4030011510	S.CER GRM31M2C2H560JV01L	B	39.8/21.9
C1005	4030011550	S.CER GRM31M2C2H680JV01L	B	16.8/91.9
C1006	4030014460	S.CER GRM31M2C2H820JV01L	B	39/109.2
C1007	4030011550	S.CER GRM31M2C2H680JV01L	B	18.1/62.1
C1009	4030011510	S.CER GRM31M2C2H560JV01L	B	20.6/118.7
C1010	4030014460	S.CER GRM31M2C2H820JV01L	B	27.1/119.5
C1121	4010006410	CER HM13SJ SL 471J 500V		
RL701	6330001550	RLY JV-12-KT		
RL801	6330001721	RLY ATN207-K1		
RL820	6330001721	RLY ATN207-K1		
RL821	6330001721	RLY ATN207-K1		
RL840	6330001721	RLY ATN207-K1		
RL841	6330001721	RLY ATN207-K1		
RL860	6330001721	RLY ATN207-K1		
RL861	6330001721	RLY ATN207-K1		
RL880	6330001721	RLY ATN207-K1		
RL881	6330001721	RLY ATN207-K1		
RL900	6330001721	RLY ATN207-K1		
RL901	6330001721	RLY ATN207-K1		
RL920	6330001721	RLY ATN207-K1		
RL921	6330001721	RLY ATN207-K1		
RL940	6330001721	RLY ATN207-K1		
RL941	6330001721	RLY ATN207-K1		
J2	6510023510	S.CNR 28FLT-SM1-TB	T	80.1/6
J980	6510023510	S.CNR 28FLT-SM1-TB	T	63.7/6
F1	5220000341	HOL FHA010-03F		
F2	5210000940	FUS 1205		
W101	9024270070	WIR 1.5D COAXIAL 175 mm		
W401	9009130165	WIR 1.5D COAXIAL 200 mm		
W701	8900013900	CBL OPC-1455		
W702	8900013910	CBL OPC-1456		
W801	7120000480	S.JMP MJP-0.4-T	B	8.3/100.9
W901	7120000480	S.JMP MJP-0.4-T	T	56.7/22
EP202	6910012350	S.BEA MMZ1608Y 102BT	B	136.7/50.6
EP703	6910012350	S.BEA MMZ1608Y 102BT	B	142.6/13.9
EP741	6910012350	S.BEA MMZ1608Y 102BT	B	76.4/11.9
EP742	6910012350	S.BEA MMZ1608Y 102BT	B	77.8/11.3
EP743	6910012350	S.BEA MMZ1608Y 102BT	B	59.8/99.5
EP747	6910012350	S.BEA MMZ1608Y 102BT	T	65/9.6
EP748	6910012350	S.BEA MMZ1608Y 102BT	T	63.8/9.6
EP751	6910012350	S.BEA MMZ1608Y 102BT	T	74.1/9.6
EP752	6910012350	S.BEA MMZ1608Y 102BT	B	63.4/5.2
EP753	6910012350	S.BEA MMZ1608Y 102BT	T	66.4/9.6
EP754	6910012350	S.BEA MMZ1608Y 102BT	B	59.3/116.1
EP756	6910012350	S.BEA MMZ1608Y 102BT	T	68.6/2.6
EP758	6910012350	S.BEA MMZ1608Y 102BT	T	70.3/9.6

M.=Mounted side (T: Mounted on the Top side, B: Mounted on the Bottom side)
S.=Surface mount

[PA UNIT]

REF NO.	ORDER NO.	DESCRIPTION	M.	H/V LOCATION
EP759	6910012350	S.BEA MMZ1608Y 102BT	T	69.1/9.6
EP760	6910012350	S.BEA MMZ1608Y 102BT	T	60.6/10
EP761	6910012350	S.BEA MMZ1608Y 102BT	T	62.5/9.6
EP762	6910012350	S.BEA MMZ1608Y 102BT	B	61/4.6
EP763	6910012350	S.BEA MMZ1608Y 102BT	B	63.3/105.6
EP767	6910012350	S.BEA MMZ1608Y 102BT	B	76.4/5.2
EP772	6910012350	S.BEA MMZ1608Y 102BT	T	96.4/3.8
EP774	6910012350	S.BEA MMZ1608Y 102BT	T	72.8/9.6
EP775	6910012350	S.BEA MMZ1608Y 102BT	B	74.8/5.2
EP776	6910012350	S.BEA MMZ1608Y 102BT	B	73.2/5.2
EP777	6910012350	S.BEA MMZ1608Y 102BT	B	70/5.2
EP778	6910012350	S.BEA MMZ1608Y 102BT	B	71.6/5.2
EP779	6910012350	S.BEA MMZ1608Y 102BT	B	68.2/5.2

[DRIVER UNIT]

REF NO.	ORDER NO.	DESCRIPTION	M.	H/V LOCATION
Q504	1590003060	S.FET PD55015	T	20/9.7
R102	7070000271	RES ERG1SJ 101 (100 Ω)		
C101	4030004750	S.CER C2012 JB 1H 103K-T	T	24.6/18.2
C102	4030011230	S.CER GRM31M2C2H390JV01L	T	11.2/4.2
J101	6910016830	CNR IMSA-9230B-1-04Z149-PT1		
J102	6910016830	CNR IMSA-9230B-1-04Z149-PT1		
J103	6910016830	CNR IMSA-9230B-1-04Z149-PT1		
J104	6910016830	CNR IMSA-9230B-1-04Z149-PT1		
J107	6910016830	CNR IMSA-9230B-1-04Z149-PT1		

[LOGIC UNIT]

REF NO.	ORDER NO.	DESCRIPTION	M.	H/V LOCATION
IC1	1130013280	S.IC TC58FVM6T5BTG65GCH	T	27.9/30.2
IC2	1130011151	S.IC SN74AHC2G08HDCT3	B	40.2/38.2
IC3	1130011151	S.IC SN74AHC2G08HDCT3	B	40.2/32.5
IC4	1130012600	S.IC SN74AHC1G04DCKR	B	43.3/33.8
IC51	1130012841	S.IC CY7C1021CV33-15BAXIT	B	24.5/28.5
IC301	1140012541	S.IC ADSP-BF532SBBCZ400	B	28.6/39.2
IC401	1110004770	S.IC BU9480F-E2	B	17.4/21.6
IC451	1110006570	S.IC TS462CPT	B	29.1/7.9
IC452	1110006570	S.IC TS462CPT	T	39.1/8.5
IC502	1110006570	S.IC TS462CPT	T	30.7/5.4
IC551	1190001611	S.IC AK4528VFP-E2/P	T	17.9/8.1
IC601	1110006570	S.IC TS462CPT	B	12.7/10.8
IC701	1130012600	S.IC SN74AHC1G04DCKR	B	2.7/15.9
IC1201	1130012791	S.IC CY22150FZXCT	B	44.5/4.5
IC1212	1140012170	S.IC BH7236AF-E2	T	57.7/7.3
IC1217	1130007181	S.IC TC7WU04FU (TE12L, F)	B	63.4/9.8
IC1218	1130012760	S.IC SN74AHC2G86HDCTR	B	52.7/6.5
IC1226	1130010870	S.IC S1D13706F00A	B	53.7/19.8
IC1251	1180002020	S.REG BA033FP-E2	T	79.5/5.2
IC1301	1130012690	S.IC HN58X24256FPIE (SOP8)	T	81.4/36.2
IC1302	1140013133	S.IC HD64F2377VFAQ33V	T	54.9/25.2
IC1303	1110005771	S.IC S-80942CNMC-G9CT2G	T	81.2/10.4
IC1304	1130011551	S.IC RX-4581NB-F	B	71.9/7.2
IC1402	1130012780	S.IC SN74AHC2G04HDCTR	T	79.1/18.9
IC2002	1130012841	S.IC CY7C1021CV33-15BAXIT	B	32.7/28.3
IC2101	1130012850	S.IC SN74LVC3G34DCUR	T	44.5/44.7
IC2102	1130012850	S.IC SN74LVC3G34DCUR	T	44.4/41.2
IC2201	1140012541	S.IC ADSP-BF532SBBCZ400	B	28.6/17.7
Q201	1550000110	S.FET RTQ035P02TR	B	18.9/42.7
Q1101	1530002060	S.TR 2SC4081 T106 R	T	82.1/20.3
Q1102	1590003520	S.TR BCR108T	T	81.8/22.7
Q1103	1510000510	S.TR 2SA1576A T106R	T	81.8/16.4
Q1201	1590003520	S.TR BCR108T	T	44.8/13.2
D201	1750001280	S.DIO CUS02 (TE85L,Q)	B	19.2/45.3
D1001	1750000370	S.DIO DA221 TL	B	64.5/36.8
D1002	1750000370	S.DIO DA221 TL	B	64.9/34.5
D1101	1790001250	S.DIO MA2S111-(TX)	T	81.9/18.4
D1106	1750000950	S.DIO MA732 (TX)	T	80.1/29.6
D1107	1790001670	S.DIO RB706F-40T106	T	82.4/31.3
D1110	1790001670	S.DIO RB706F-40T106	T	75.7/32.3
D1111	1790001670	S.DIO RB706F-40T106	T	75.3/29.3
D1112	1790001670	S.DIO RB706F-40T106	B	79.2/29.1
D1113	1790001670	S.DIO RB706F-40T106	B	82.3/30.6
D1201	1790001250	S.DIO MA2S111-(TX)	B	83/40.4
D1301	1790000660	S.DIO MA728 (TX)	B	77.5/2.9
D1304	1750000370	S.DIO DA221 TL	T	76.1/19.9
D1305	1750000370	S.DIO DA221 TL	T	75.8/16.8
D1306	1750000370	S.DIO DA221 TL	B	49.3/32.9
D1307	1750000370	S.DIO DA221 TL	B	51.4/33.3
D1311	1790001250	S.DIO MA2S111-(TX)	B	80.9/19.6
D1312	1790001250	S.DIO MA2S111-(TX)	B	83.1/18.5
D1313	1790001250	S.DIO MA2S111-(TX)	B	80/22.6
D1314	1790001240	S.DIO MA2S728-(TX)	B	81.7/22.4
D1331	1790001250	S.DIO MA2S111-(TX)	B	65.6/17.5
X1201	6050012140	S.XTL CR-805	[USA]	B 61.3/3.1
	6050012150	S.XTL CR-806	[Others]	B 61.3/3.1
X1301	6050012190	S.XTL CR-809		B 60.4/30.8
L201	6200011900	S.COL LQH43CN100K03L	T	16/41.9
L202	6200009491	S.COL CDRH6D28NP-100NC	B	13.3/41.4
L551	6200005011	S.COL NLV25T-100J	T	11/9.8
L552	6200005011	S.COL NLV25T-100J	T	10.4/5.8
L1202	6200002041	S.COL NLV25T-101J	B	52.3/2.3
L1203	6200002041	S.COL NLV25T-101J	T	66.7/3.5
L1204	6200002041	S.COL NLV25T-101J	B	57.9/10.3
L2101	6200005011	S.COL NLV25T-100J	T	40.9/45
L2102	6200005011	S.COL NLV25T-100J	T	40.2/41.5
R2	7030005090	S.RES ERJ2GEJ 104 X (100 kΩ)	T	39.5/30.1
R3	7030005090	S.RES ERJ2GEJ 104 X (100 kΩ)	T	39.5/32.3
R4	7030005090	S.RES ERJ2GEJ 104 X (100 kΩ)	T	31.8/45.8
R5	7030005090	S.RES ERJ2GEJ 104 X (100 kΩ)	T	30.9/45.8
R6	7030005090	S.RES ERJ2GEJ 104 X (100 kΩ)	T	30/45.8
R203	7030000010	S.RES MCR10EZHJ JPW	T	20.7/45.6
R301	7030004980	S.RES ERJ2GEJ 101 X (100 Ω)	T	25.4/45.8
R302	7030005050	S.RES ERJ2GEJ 103 X (10 kΩ)	T	26.9/45.8
R303	7030005050	S.RES ERJ2GEJ 103 X (10 kΩ)	T	27.8/45.8
R306	7030005050	S.RES ERJ2GEJ 103 X (10 kΩ)	B	37.3/32.2
R307	7030005050	S.RES ERJ2GEJ 103 X (10 kΩ)	T	22/41.4
R308	7030005050	S.RES ERJ2GEJ 103 X (10 kΩ)	T	22/40.5
R310	7030005050	S.RES ERJ2GEJ 103 X (10 kΩ)	B	36.7/35.4
R312	7030010040	S.RES ERJ2GEJ-JPW	B	33.6/45.9
R313	7030010040	S.RES ERJ2GEJ-JPW	B	35.6/43.3

M.=Mounted side (T: Mounted on the Top side, B: Mounted on the Bottom side)
S.=Surface mount

[LOGIC UNIT]

REF NO.	ORDER NO.	DESCRIPTION	M.	H/V LOCATION
R314	7030010040	S.RES ERJ2GEJ-JPW	B	35.6/40.6
R413	7030004980	S.RES ERJ2GEJ 101 X (100 Ω)	B	18.1/16.8
R414	7030004980	S.RES ERJ2GEJ 101 X (100 Ω)	T	16.3/19.9
R415	7030004980	S.RES ERJ2GEJ 101 X (100 Ω)	B	19/16.8
R416	7030004980	S.RES ERJ2GEJ 101 X (100 Ω)	B	17.2/16.8
R462	7030004980	S.RES ERJ2GEJ 101 X (100 Ω)	B	33.8/7.4
R463	7030004980	S.RES ERJ2GEJ 101 X (100 Ω)	T	43.6/8.8
R464	7030004980	S.RES ERJ2GEJ 101 X (100 Ω)	B	26.2/5.7
R465	7030009270	S.RES ERJ2GEJ 821 X (820 Ω)	B	28.6/5.2
R467	7030004980	S.RES ERJ2GEJ 101 X (100 Ω)	B	31.3/4.3
R469	7030009270	S.RES ERJ2GEJ 821 X (820 Ω)	B	30.4/4.3
R470	7030009140	S.RES ERJ2GEJ 272 X (2.7 kΩ)	T	29.4/3
R471	7030009140	S.RES ERJ2GEJ 272 X (2.7 kΩ)	T	34/3.3
R472	7030005040	S.RES ERJ2GEJ 472 X (4.7 kΩ)	T	38.6/4.2
R473	7030005040	S.RES ERJ2GEJ 472 X (4.7 kΩ)	T	38.6/3.2
R474	7030009140	S.RES ERJ2GEJ 272 X (2.7 kΩ)	B	24.8/7.1
R475	7030009140	S.RES ERJ2GEJ 272 X (2.7 kΩ)	B	33.8/9.2
R476	7030005040	S.RES ERJ2GEJ 472 X (4.7 kΩ)	T	40.2/3.3
R507	7030004980	S.RES ERJ2GEJ 101 X (100 Ω)	T	26/3.5
R508	7030004980	S.RES ERJ2GEJ 101 X (100 Ω)	T	31.6/8.9
R510	7030005040	S.RES ERJ2GEJ 472 X (4.7 kΩ)	T	32.5/8.9
R511	7030005040	S.RES ERJ2GEJ 472 X (4.7 kΩ)	T	28.9/8.9
R512	7030004980	S.RES ERJ2GEJ 101 X (100 Ω)	T	29.8/8.9
R514	7030005050	S.RES ERJ2GEJ 103 X (10 kΩ)	T	34.9/8.8
R515	7030005050	S.RES ERJ2GEJ 103 X (10 kΩ)	T	34.9/7.9
R516	7030005040	S.RES ERJ2GEJ 472 X (4.7 kΩ)	T	39/12.8
R517	7030005040	S.RES ERJ2GEJ 472 X (4.7 kΩ)	T	36.5/11
R518	7030009140	S.RES ERJ2GEJ 272 X (2.7 kΩ)	T	36.4/5.6
R519	7030009140	S.RES ERJ2GEJ 272 X (2.7 kΩ)	T	26.4/5.6
R520	7030005040	S.RES ERJ2GEJ 472 X (4.7 kΩ)	T	41.3/12.8
R551	7030004980	S.RES ERJ2GEJ 101 X (100 Ω)	T	16.5/13.4
R553	7030004980	S.RES ERJ2GEJ 101 X (100 Ω)	T	14.7/13.4
R554	7030005090	S.RES ERJ2GEJ 104 X (100 kΩ)	T	15.4/3.2
R568	7030004980	S.RES ERJ2GEJ 101 X (100 Ω)	T	12.9/13.4
R569	7030004980	S.RES ERJ2GEJ 101 X (100 Ω)	T	15.6/13.4
R570	7030004980	S.RES ERJ2GEJ 101 X (100 Ω)	T	13.8/13.4
R571	7030009320	S.RES ERJ2GEJ 4R7 X (4.7 Ω)	B	20.7/8.4
R601	7030004980	S.RES ERJ2GEJ 101 X (100 Ω)	T	6.2/12.6
R602	7030007300	S.RES ERJ2GEJ 332 X (3.3 kΩ)	T	9.2/9.2
R603	7030005040	S.RES ERJ2GEJ 472 X (4.7 kΩ)	B	12.3/4.8
R604	7030005040	S.RES ERJ2GEJ 472 X (4.7 kΩ)	B	13.2/4.8
R605	7030007300	S.RES ERJ2GEJ 332 X (3.3 kΩ)	B	14.4/5.1
R606	7030007300	S.RES ERJ2GEJ 332 X (3.3 kΩ)	B	12.8/7.2
R607	7030005290	S.RES ERJ2GEJ 682 X (6.8 kΩ)	B	13.8/7.2
R608	7030005290	S.RES ERJ2GEJ 682 X (6.8 kΩ)	B	14.8/6.4
R609	7030005040	S.RES ERJ2GEJ 472 X (4.7 kΩ)	B	3.3/12.4
R610	7030005040	S.RES ERJ2GEJ 472 X (4.7 kΩ)	B	8.9/4.2
R611	7030005040	S.RES ERJ2GEJ 472 X (4.7 kΩ)	B	9.8/4.2
R612	7030007300	S.RES ERJ2GEJ 332 X (3.3 kΩ)	B	11.4/5.6
R613	7030007300	S.RES ERJ2GEJ 332 X (3.3 kΩ)	B	8.8/6.9
R614	7030005290	S.RES ERJ2GEJ 682 X (6.8 kΩ)	B	9.7/6.9
R615	7030005290	S.RES ERJ2GEJ 682 X (6.8 kΩ)	B	10.6/6.9
R618	7030005120	S.RES ERJ2GEJ 102 X (1 kΩ)	B	14.4/4.2
R619	7030005120	S.RES ERJ2GEJ 102 X (1 kΩ)	B	10.7/4.2
R701	7030005050	S.RES ERJ2GEJ 103 X (10 kΩ)	B	4.6/22.8
R702	7030005050	S.RES ERJ2GEJ 103 X (10 kΩ)	B	4.6/23.7
R703	7030005050	S.RES ERJ2GEJ 103 X (10 kΩ)	B	4.5/25.9
R705	7030005120	S.RES ERJ2GEJ 102 X (1 kΩ)	B	5/21
R706	7030005050	S.RES ERJ2GEJ 103 X (10 kΩ)	B	4.4/17.1
R707	7030007250	S.RES ERJ2GEJ 220 X (22 Ω)	B	4.4/15.5
R1001	7030005120	S.RES ERJ2GEJ 102 X (1 kΩ)	B	70.8/37
R1002	7030005050	S.RES ERJ2GEJ 103 X (10 kΩ)	B	65.9/32.3
R1003	7030005160	S.RES ERJ2GEJ 105 X (1 MΩ)	B	70.4/35.8
R1004	7030005240	S.RES ERJ2GEJ 473 X (47 kΩ)	B	66.1/18.5
R1006	7030005120	S.RES ERJ2GEJ 102 X (1 kΩ)	B	52/34.8
R1007	7030005120	S.RES ERJ2GEJ 102 X (1 kΩ)	B	53.2/32
R1008	7030005120	S.RES ERJ2GEJ 102 X (1 kΩ)	B	75.1/20.4
R1010	7030005240	S.RES ERJ2GEJ 473 X (47 kΩ)	B	76.7/19.8
R1012	7030005000	S.RES ERJ2GEJ 471 X (470 Ω)	B	66.5/34.2
R1013	7030005000	S.RES ERJ2GEJ 471 X (470 Ω)	B	66.5/36.2
R1015	7030005240	S.RES ERJ2GEJ 473 X (47 kΩ)	B	50.4/34.8
R1016	7030005240	S.RES ERJ2GEJ 473 X (47 kΩ)	B	51/31.7
R1018	7030007340	S.RES ERJ2GEJ 153 X (15 kΩ)	B	63.3/34.4
R1019	7030007340	S.RES ERJ2GEJ 153 X (15 kΩ)	B	62.9/36.1
R1101	7030008290	S.RES ERJ2GEJ 183 X (18 kΩ)	T	80.1/15.4
R1102	7030008010	S.RES ERJ2GEJ 123 X (12 kΩ)	T	79.9/21.9
R1103	7030005120	S.RES ERJ2GEJ 102 X (1 kΩ)	T	79.9/22.8
R1104	7030005120	S.RES ERJ2GEJ 102 X (1 kΩ)	T	74.5/20.7
R1105	7030005050	S.RES ERJ2GEJ 103 X (10 kΩ)	T	79.6/14.2
R1106	7030005240	S.RES ERJ2GEJ 473 X (47 kΩ)	T	83.3/14.4
R1107	7030005090	S.RES ERJ2GEJ 104 X (100 kΩ)	T	79.2/15.4
R1108	7030005090	S.RES ERJ2GEJ 104 X (100 kΩ)	T	78.3/14.8
R1109	7030005160	S.RES ERJ2GEJ 105 X (1 MΩ)	T	78.3/21.9
R1110	7030005240	S.RES ERJ2GEJ 473 X (47 kΩ)	T	76.7/21.4
R1111	7030005090	S.RES ERJ2GEJ 104 X (100 kΩ)	T	77.4/14.8
R1113	7030007290	S.RES ERJ2GEJ 222 X (2.2 kΩ)	T	83.2/29.3
R1114	7030007300	S.RES ERJ2GEJ 332 X (3.3 kΩ)	T	82.3/29.3
R1115	7030005120	S.RES ERJ2GEJ 102 X (1 kΩ)	T	76.8/26.3
R1116	7030005120	S.RES ERJ2GEJ 102 X (1 kΩ)	T	76.9/28.1
R1117	7030005120	S.RES ERJ2GEJ 102 X (1 kΩ)	B	82.7/22.2
R1118	7030007300	S.RES ERJ2GEJ 332 X (3.3 kΩ)	B	83/23.8

[LOGIC UNIT]

REF NO.	ORDER NO.	DESCRIPTION	M.	H/V LOCATION
R1119	7030007300	S.RES ERJ2GEJ 332 X (3.3 kΩ)	B	83.8/22.2
R1120	7030005120	S.RES ERJ2GEJ 102 X (1 kΩ)	B	84.1/23.8
R1123	7030005160	S.RES ERJ2GEJ 105 X (1 MΩ)	B	66.9/24.4
R1124	7030005120	S.RES ERJ2GEJ 102 X (1 kΩ)	B	82/20
R1126	7030005160	S.RES ERJ2GEJ 105 X (1 MΩ)	B	66.9/23.5
R1127	7030010040	S.RES ERJ2GEJ-JPW	T	73.7/18.5
R1128	7030005120	S.RES ERJ2GEJ 102 X (1 kΩ)	B	83.2/20.1
R1129	7030007300	S.RES ERJ2GEJ 332 X (3.3 kΩ)	B	81.9/28.4
R1131	7030005090	S.RES ERJ2GEJ 104 X (100 kΩ)	B	78.5/26.1
R1132	7030005090	S.RES ERJ2GEJ 104 X (100 kΩ)	B	81.4/24.4
R1201	7030005160	S.RES ERJ2GEJ 105 X (1 MΩ)	B	62.7/7.6
R1202	7030005050	S.RES ERJ2GEJ 103 X (10 kΩ)	B	49.2/7.5
R1203	7030005050	S.RES ERJ2GEJ 103 X (10 kΩ)	B	49.2/8.4
R1204	7030005050	S.RES ERJ2GEJ 103 X (10 kΩ)	B	49.7/9.6
R1205	7030010040	S.RES ERJ2GEJ-JPW	B	49.2/3.1
R1206	7030007570	S.RES ERJ2GEJ 122 X (1.2 kΩ)	B	46.1/9.6
R1207	7030007570	S.RES ERJ2GEJ 122 X (1.2 kΩ)	B	43.9/9.6
R1208	7030007570	S.RES ERJ2GEJ 122 X (1.2 kΩ)	B	43.5/11.4
R1209	7030009710	S.RES ERJ2GEJ 203 X (20 kΩ)	B	48.8/9.6
R1210	7030007350	S.RES ERJ2GEJ 393 X (39 kΩ)	B	47.9/9.6
R1211	7030005050	S.RES ERJ2GEJ 103 X (10 kΩ)	B	48.9/11.4
R1212	7030005050	S.RES ERJ2GEJ 103 X (10 kΩ)	B	48/11.4
R1213	7030005050	S.RES ERJ2GEJ 103 X (10 kΩ)	B	47.1/11.4
R1214	7030009710	S.RES ERJ2GEJ 203 X (20 kΩ)	B	46.2/11.7
R1215	7030007350	S.RES ERJ2GEJ 393 X (39 kΩ)	B	45.3/11.4
R1216	7030005050	S.RES ERJ2GEJ 103 X (10 kΩ)	B	44.7/12.6
R1217	7030005050	S.RES ERJ2GEJ 103 X (10 kΩ)	B	44.7/13.5
R1218	7030005050	S.RES ERJ2GEJ 103 X (10 kΩ)	B	44.7/14.4
R1219	7030005040	S.RES ERJ2GEJ 472 X (4.7 kΩ)	B	74.4/41.1
R1220	7030009710	S.RES ERJ2GEJ 203 X (20 kΩ)	B	44.7/15.3
R1221	7030005040	S.RES ERJ2GEJ 472 X (4.7 kΩ)	B	82.9/41.6
R1222	7030005040	S.RES ERJ2GEJ 472 X (4.7 kΩ)	B	74.4/40.2
R1223	7030005040	S.RES ERJ2GEJ 472 X (4.7 kΩ)	B	74.4/39.3
R1224	7030005040	S.RES ERJ2GEJ 472 X (4.7 kΩ)	B	82.9/39.3
R1225	7030005240	S.RES ERJ2GEJ 473 X (47 kΩ)	B	83.1/35.7
R1226	7030005240	S.RES ERJ2GEJ 473 X (47 kΩ)	B	74.4/37.5
R1227	7030005240	S.RES ERJ2GEJ 473 X (47 kΩ)	B	73.8/38.4
R1228	7030005240	S.RES ERJ2GEJ 473 X (47 kΩ)	B	82.2/35.7
R1229	7030007350	S.RES ERJ2GEJ 393 X (39 kΩ)	B	43.5/15.4
R1230	7030004970	S.RES ERJ2GEJ 470 X (47 Ω)	B	49.2/2.2
R1231	7030005050	S.RES ERJ2GEJ 103 X (10 kΩ)	B	48.8/5.4
R1232	7030005220	S.RES ERJ2GEJ 223 X (22 kΩ)	B	40.3/3.2
R1235	7030007270	S.RES ERJ2GEJ 151 X (150 Ω)	T	66.2/5.9
R1236	7030007270	S.RES ERJ2GEJ 151 X (150 Ω)	T	66.2/7
R1237	7030007290	S.RES ERJ2GEJ 222 X (2.2 kΩ)	B	61.1/7.6
R1251	7030011250	S.RES ERJ1TY 390U (39 Ω)	T	70.3/5.8
R1301	7030005220	S.RES ERJ2GEJ 223 X (22 kΩ)	T	78.1/37.8
R1302	7030005050	S.RES ERJ2GEJ 103 X (10 kΩ)	T	78.1/36
R1303	7030005240	S.RES ERJ2GEJ 473 X (47 kΩ)	B	66/21.2
R1304	7030005240	S.RES ERJ2GEJ 473 X (47 kΩ)	B	66/20.3
R1305	7030009160	S.RES ERJ2GEJ 181 X (180 Ω)	T	68.5/25.9
R1306	7030005060	S.RES ERJ2GEJ 333 X (33 kΩ)	T	78.7/11.4
R1307	7030005040	S.RES ERJ2GEJ 472 X (4.7 kΩ)	T	68/21.9
R1308	7030005110	S.RES ERJ2GEJ 224 X (220 kΩ)	T	67.5/20
R1309	7030005110	S.RES ERJ2GEJ 224 X (220 kΩ)	T	69/19.4
R1310	7030005110	S.RES ERJ2GEJ 224 X (220 kΩ)	T	67.5/18.8
R1311	7030005110	S.RES ERJ2GEJ 224 X (220 kΩ)	T	69/18.2
R1312	7030005110	S.RES ERJ2GEJ 224 X (220 kΩ)	T	67.5/17.6
R1313	7030005110	S.RES ERJ2GEJ 224 X (220 kΩ)	T	69/17
R1314	7030005110	S.RES ERJ2GEJ 224 X (220 kΩ)	T	67.5/16.4
R1315	7030005110	S.RES ERJ2GEJ 224 X (220 kΩ)	T	69/15.8
R1316	7030005110	S.RES ERJ2GEJ 224 X (220 kΩ)	B	66.6/12.3
R1317	7030005110	S.RES ERJ2GEJ 224 X (220 kΩ)	B	65.7/12.3
R1318	7030005110	S.RES ERJ2GEJ 224 X (220 kΩ)	B	64.8/12.3
R1319	7030005110	S.RES ERJ2GEJ 224 X (220 kΩ)	B	63.9/12.3
R1320	7030005110	S.RES ERJ2GEJ 224 X (220 kΩ)	B	63/12.3
R1321	7030005110	S.RES ERJ2GEJ 224 X (220 kΩ)	B	62.1/12.3
R1322	7030005110	S.RES ERJ2GEJ 224 X (220 kΩ)	B	61.2/12.3
R1323	7030005110	S.RES ERJ2GEJ 224 X (220 kΩ)	B	60.3/12.1
R1324	7030005050	S.RES ERJ2GEJ 103 X (10 kΩ)	T	80.5/12.6
R1325	7030007350	S.RES ERJ2GEJ 393 X (39 kΩ)	T	78.1/9.8
R1326	7030005010	S.RES ERJ2GEJ 681 X (680 Ω)	B	78.9/2
R1327	7030005240	S.RES ERJ2GEJ 473 X (47 kΩ)	B	66/19.4
R1328	7030005050	S.RES ERJ2GEJ 103 X (10 kΩ)	B	75.9/6.4
R1329	7030005240	S.RES ERJ2GEJ 473 X (47 kΩ)	B	75.9/5
R1331	7030010040	S.RES ERJ2GEJ-JPW	B	75.9/3.2
R1332	7030005040	S.RES ERJ2GEJ 472 X (4.7 kΩ)	B	75.9/4.1
R1333	7030005110	S.RES ERJ2GEJ 224 X (220 kΩ)	T	67.4/26.9
R1334	7030005050	S.RES ERJ2GEJ 103 X (10 kΩ)	T	78.3/12.6
R1335	7030010040	S.RES ERJ2GEJ-JPW	B	78.5/5.1
R1337	7030005240	S.RES ERJ2GEJ 473 X (47 kΩ)	T	40.9/15.5
R1338	7030005240	S.RES ERJ2GEJ 473 X (47 kΩ)	T	40.9/16.4
R1339	7030007290	S.RES ERJ2GEJ 222 X (2.2 kΩ)	B	65.5/22.4
R1401	7030005240	S.RES ERJ2GEJ 473 X (47 kΩ)	B	62.7/24.2
R1402	7030005240	S.RES ERJ2GEJ 473 X (47 kΩ)	B	76.7/21.8
R1403	7030005240	S.RES ERJ2GEJ 473 X (47 kΩ)	B	78.3/22.1
R1404	7030005240	S.RES ERJ2GEJ 473 X (47 kΩ)	B	76.7/22.9
R1405	7030005240	S.RES		

[LOGIC UNIT]

REF NO.	ORDER NO.	DESCRIPTION	M.	H/V LOCATION
R1409	7030005240	S.RES ERJ2GEJ 473 X (47 kΩ)	B	78.3/24.7
R1410	7030005240	S.RES ERJ2GEJ 473 X (47 kΩ)	B	78.3/23.5
R1411	7030005240	S.RES ERJ2GEJ 473 X (47 kΩ)	B	76.7/24.1
R1412	7030005240	S.RES ERJ2GEJ 473 X (47 kΩ)	B	43.6/24.7
R1413	7030005240	S.RES ERJ2GEJ 473 X (47 kΩ)	T	42.4/17.9
R1502	7030007300	S.RES ERJ2GEJ 332 X (3.3 kΩ)	B	80.9/28.4
R2101	7030005050	S.RES ERJ2GEJ 103 X (10 kΩ)	T	48.1/44.9
R2102	7030005050	S.RES ERJ2GEJ 103 X (10 kΩ)	T	47.7/42.7
R2103	7030005050	S.RES ERJ2GEJ 103 X (10 kΩ)	T	47.6/40.5
R2104	7030005050	S.RES ERJ2GEJ 103 X (10 kΩ)	T	47.7/43.7
R2105	7030005050	S.RES ERJ2GEJ 103 X (10 kΩ)	T	47.5/41.7
R2110	7030010040	S.RES ERJ2GEJ-JPW	B	21.4/22.5
R2112	7030005040	S.RES ERJ2GEJ 472 X (4.7 kΩ)	T	38.5/44.4
R2201	7030004980	S.RES ERJ2GEJ 101 X (100 Ω)	T	31.5/11.1
R2202	7030005050	S.RES ERJ2GEJ 103 X (10 kΩ)	T	30.6/11.1
R2203	7030005050	S.RES ERJ2GEJ 103 X (10 kΩ)	T	21.5/22.4
R2204	7030005050	S.RES ERJ2GEJ 103 X (10 kΩ)	T	35.2/15.5
R2205	7030005050	S.RES ERJ2GEJ 103 X (10 kΩ)	T	35.2/16.4
R2206	7030005050	S.RES ERJ2GEJ 103 X (10 kΩ)	T	21.5/21.5
R2214	7030005050	S.RES ERJ2GEJ 103 X (10 kΩ)	T	27.5/11.1
R2215	7030005050	S.RES ERJ2GEJ 103 X (10 kΩ)	T	28.4/11.1
R2216	7030010040	S.RES ERJ2GEJ-JPW	T	34.8/37.3
C1	4030016930	S.CER ECJ0EB1A104K	T	16.9/25.1
C2	4030016930	S.CER ECJ0EB1A104K	B	38.1/36.1
C3	4030016930	S.CER ECJ0EB1A104K	B	39.5/29
C4	4030016930	S.CER ECJ0EB1A104K	B	42.4/35.8
C5	4550007310	S.TAN F930J227MNMBA	T	40.8/23.4
C51	4030016930	S.CER ECJ0EB1A104K	B	19.2/27.4
C52	4030016930	S.CER ECJ0EB1A104K	B	19.2/28.3
C53	4550007310	S.TAN F930J227MNMBA	B	11.4/29.8
C201	4030016930	S.CER ECJ0EB1A104K	B	19/40.2
C202	4550007310	S.TAN F930J227MNMBA	B	4.4/42.9
C203	4030018960	S.CER C3216 JB 1C 106MT-N	T	18.8/45.5
C204	4030016930	S.CER ECJ0EB1A104K	T	11.9/40.2
C205	4030016930	S.CER ECJ0EB1A104K	T	11.9/41.8
C206	4030016930	S.CER ECJ0EB1A104K	B	8.8/43.4
C207	4030018960	S.CER C3216 JB 1C 106MT-N	B	9/46.5
C208	4550006780	S.TAN TEESVB2 OJ 476M8R	T	11.5/46.1
C209	4550006780	S.TAN TEESVB2 OJ 476M8R	T	4.6/46
C302	4030016930	S.CER ECJ0EB1A104K	T	30.2/40.4
C303	4030016930	S.CER ECJ0EB1A104K	T	30.4/37.8
C304	4030016930	S.CER ECJ0EB1A104K	T	26.9/37.2
C305	4030016930	S.CER ECJ0EB1A104K	T	34.1/45.8
C306	4030016930	S.CER ECJ0EB1A104K	T	29.2/37.2
C307	4030016930	S.CER ECJ0EB1A104K	B	36.8/38.6
C308	4030016930	S.CER ECJ0EB1A104K	T	27.3/39.3
C309	4030016930	S.CER ECJ0EB1A104K	T	30.6/39.1
C310	4030016930	S.CER ECJ0EB1A104K	T	24.5/45.8
C311	4030016930	S.CER ECJ0EB1A104K	T	22/42.3
C312	4030016930	S.CER ECJ0EB1A104K	T	27.8/40.5
C313	4030016930	S.CER ECJ0EB1A104K	T	22/39.6
C314	4030016930	S.CER ECJ0EB1A104K	T	29.1/45.8
C315	4030016930	S.CER ECJ0EB1A104K	T	27.3/38.4
C316	4030016930	S.CER ECJ0EB1A104K	T	30.4/36.9
C317	4030016930	S.CER ECJ0EB1A104K	T	26.9/40.5
C318	4030016930	S.CER ECJ0EB1A104K	T	31.1/40.4
C319	4030016930	S.CER ECJ0EB1A104K	T	29.3/40.4
C320	4030016930	S.CER ECJ0EB1A104K	T	27.8/37.2
C413	4030018960	S.CER C3216 JB 1C 106MT-N	B	21.3/19.6
C414	4030016930	S.CER ECJ0EB1A104K	B	16.3/16.8
C415	4030018960	S.CER C3216 JB 1C 106MT-N	B	15.6/26.3
C461	4030016930	S.CER ECJ0EB1A104K	B	34.2/4.3
C462	4030018960	S.CER C3216 JB 1C 106MT-N	B	35.3/5.8
C463	4030018960	S.CER C3216 JB 1C 106MT-N	T	42/8.7
C464	4030016930	S.CER ECJ0EB1A104K	T	43.6/10.4
C465	4030017740	S.CER ECJ0EB1E821K	B	27.4/5.5
C466	4030017760	S.CER ECJ0EB1H222K	B	29.5/4.3
C467	4030017740	S.CER ECJ0EB1E821K	B	30.7/5.5
C468	4030018560	S.CER C2012 JB 1A 475K-T	T	31.8/2.6
C469	4030016930	S.CER ECJ0EB1A104K	B	24.8/8.7
C470	4030016930	S.CER ECJ0EB1A104K	B	33.8/8.3
C471	4030018560	S.CER C2012 JB 1A 475K-T	T	36.2/4.2
C472	4030018560	S.CER C2012 JB 1A 475K-T	T	36.2/2.5
C473	4030016930	S.CER ECJ0EB1A104K	T	40.2/4.2
C509	4030018960	S.CER C3216 JB 1C 106MT-N	T	24.2/5.5
C510	4030016930	S.CER ECJ0EB1A104K	T	26/4.4
C511	4030017760	S.CER ECJ0EB1H222K	T	30.7/8.9
C512	4030017690	S.CER ECJ0EC1H121J	T	32.1/7.7
C513	4030017690	S.CER ECJ0EC1H121J	T	29.4/7.7
C514	4030016930	S.CER ECJ0EB1A104K	T	36.4/6.5
C515	4030018860	S.CER ECJ0EB0J105K	T	36.5/9.2
C516	4030018860	S.CER ECJ0EB0J105K	T	36.5/8.3
C517	4030018860	S.CER ECJ0EB0J105K	T	36.5/10.1
C518	4030016930	S.CER ECJ0EB1A104K	T	26.1/6.8
C519	4030016930	S.CER ECJ0EB1A104K	T	41.3/11.9
C522	4030017780	S.CER ECJ0EB1E472K	B	38.9/9.8
C523	4030017780	S.CER ECJ0EB1E472K	B	34/3
C524	4030017780	S.CER ECJ0EB1E472K	T	2.5/8
C525	4030017780	S.CER ECJ0EB1E472K	T	22.5/3

[LOGIC UNIT]

REF NO.	ORDER NO.	DESCRIPTION	M.	H/V LOCATION
C526	4030017780	S.CER ECJ0EB1E472K	T	43/4
C527	4030017780	S.CER ECJ0EB1E472K	B	26/3
C551	4030018520	S.CER C1608 JB OJ 225M-T	T	20/13.8
C553	4030016930	S.CER ECJ0EB1A104K	T	19/13.9
C563	4030018960	S.CER C3216 JB 1C 106MT-N	B	18.9/6.6
C564	4030016930	S.CER ECJ0EB1A104K	T	18.1/13.9
C565	4030016930	S.CER ECJ0EB1A104K	T	17.8/3.2
C566	4030016930	S.CER ECJ0EB1A104K	T	19.4/3.2
C567	4030018960	S.CER C3216 JB 1C 106MT-N	B	21.3/12.3
C569	4030018960	S.CER C3216 JB 1C 106MT-N	B	19.2/12.3
C601	4030018960	S.CER C3216 JB 1C 106MT-N	T	5.6/8.7
C602	4030016930	S.CER ECJ0EB1A104K	T	7.8/11.8
C603	4030018820	S.CER ECJ0EB1H561K	B	13.4/6
C604	4510008640	S.ELE 6 CE 100 FE	B	4.8/7
C605	4030016930	S.CER ECJ0EB1A104K	B	3.3/11.4
C606	4030018580	S.CER C1608 CH 1H 821J-T	B	9.6/5.6
C607	4030017440	S.CER ECJ0EC1H221J	B	13.3/8.4
C608	4030017440	S.CER ECJ0EC1H221J	B	14.8/8
C609	4030018860	S.CER ECJ0EB0J105K	B	15.8/13.7
C610	4030010760	S.CER C1608 CH 1H 331J-T	B	9.6/8.3
C611	4030010760	S.CER C1608 CH 1H 331J-T	B	11.8/7.7
C612	4030018960	S.CER C3216 JB 1C 106MT-N	B	8.8/13.7
C613	4550006780	S.TAN TEESVB2 OJ 476M8R	B	20.6/2.7
C614	4550006780	S.TAN TEESVB2 OJ 476M8R	T	5/4.1
C651	4030017460	S.CER ECJ0EB1E102K	B	65.5/31.4
C652	4030017460	S.CER ECJ0EB1E102K	B	66/16.4
C653	4030017460	S.CER ECJ0EB1E102K	B	77.1/20.9
C654	4030017430	S.CER ECJ0EC1H101J	B	77.2/28.2
C655	4030017430	S.CER ECJ0EC1H101J	B	76.5/27.1
C656	4030017430	S.CER ECJ0EC1H101J	B	76.1/26.2
C701	4030016930	S.CER ECJ0EB1A104K	B	3/13.5
C702	4030017780	S.CER ECJ0EB1E472K	B	4.4/18.8
C703	4030017780	S.CER ECJ0EB1E472K	B	7.5/26.1
C704	4030017780	S.CER ECJ0EB1E472K	B	19.7/26.2
C705	4030017430	S.CER ECJ0EC1H101J	B	4.6/21.9
C706	4030017430	S.CER ECJ0EC1H101J	B	4.6/24.6
C707	4030017430	S.CER ECJ0EC1H101J	B	3.9/27.2
C708	4030017430	S.CER ECJ0EC1H101J	B	6.9/26.1
C709	4030017430	S.CER ECJ0EC1H101J	T	2.5/20.1
C711	4550007310	S.TAN F930J227MNMBA	T	5.5/18.9
C715	4030017460	S.CER ECJ0EB1E102K	T	2.2/17.6
C716	4030017460	S.CER ECJ0EB1E102K	T	2.2/18.6
C717	4030017460	S.CER ECJ0EB1E102K	T	2.2/16.6
C1001	4030017780	S.CER ECJ0EB1E472K	B	76.7/18.9
C1002	4030017780	S.CER ECJ0EB1E472K	B	70.4/38.2
C1101	4030017780	S.CER ECJ0EB1E472K	T	79.9/23.7
C1102	4030017780	S.CER ECJ0EB1E472K	T	73.6/20.7
C1103	4030016930	S.CER ECJ0EB1A104K	T	81.8/14.5
C1106	4030017780	S.CER ECJ0EB1E472K	T	79.7/31.9
C1107	4030018900	S.CER ECJ0EB0J474K	B	80.1/25.5
C1108	4030018900	S.CER ECJ0EB0J474K	B	81.4/25.4
C1109	4030017780	S.CER ECJ0EB1E472K	T	79.7/26.3
C1110	4030017780	S.CER ECJ0EB1E472K	T	80.7/26.3
C1111	4030017780	S.CER ECJ0EB1E472K	T	81.7/26.3
C1112	4030017780	S.CER ECJ0EB1E472K	B	82.9/28.4
C1201	4030016930	S.CER ECJ0EB1A104K	B	50.6/4.3
C1202	4030017780	S.CER ECJ0EB1E472K	B	53.2/4.3
C1203	4030017650	S.CER ECJ0EC1H270J	B	62.7/6.7
C1204	4030016930	S.CER ECJ0EB1A104K	B	47/9.8
C1205	4030016930	S.CER ECJ0EB1A104K	B	45.2/9.6
C1206	4030016930	S.CER ECJ0EB1A104K	B	43.5/13.8
C1207	4030017430	S.CER ECJ0EC1H101J	B	47/9.6
C1208	4030017430	S.CER ECJ0EC1H101J	B	43.9/8.7
C1209	4030017430	S.CER ECJ0EC1H101J	B	44.4/11.4
C1210	4030017650	S.CER ECJ0EC1H270J	B	61.1/6.7
C1211	4030018860	S.CER ECJ0EB0J105K	B	60.2/10.5
C1212	4030016930	S.CER ECJ0EB1A104K	B	49.7/4.3
C1213	4030016930	S.CER ECJ0EB1A104K	B	49.2/6.6
C1214	4030016930	S.CER ECJ0EB1A104K	B	40.3/4.8
C1215	4030016930	S.CER ECJ0EB1A104K	B	64.2/19.3
C1216	4030016930	S.CER ECJ0EB1A104K	B	53.7/30.3
C1217	4030016930	S.CER ECJ0EB1A104K	B	57.5/29.2
C1218	4030016930	S.CER ECJ0EB1A104K	B	44.8/23.9
C1219	4030016930	S.CER ECJ0EB1A104K	B	46.3/13.2
C1220	4030016930	S.CER ECJ0EB1A104K	B	56/8.8
C1221	4030016930	S.CER ECJ0EB1A104K	B	60.5/13.7
C1222	4030016930	S.CER ECJ0EB1A104K	B	60.9/25.6
C1223	4030016930	S.CER ECJ0EB1A104K	T	52.7/12.3
C1225	4030018960	S.CER C3216 JB 1C 106MT-N	T	67/10.2
C1251	4030012610	S.CER C2012 JB 1C 474K-T	T	73.2/9.2
C1252	4550007320	S.TAN F930J226MAABMA	T	73.4/4.1
C1301	4030016930	S.CER ECJ0EB1A104K	T	80.1/40.3
C1302	4030018960	S.CER C3216 JB 1C 106MT-N	T	47.9/11.4
C1303	4030016790	S.CER ECJ0EB1C103K	T	67.9/30.4
C1304	4030016930	S.CER ECJ0EB1A104K	T	41.7/31.5
C1305	4030018960	S.CER C3216 JB 1C 106MT-N	T	44.3/37.2
C1306	4030016790	S.CER ECJ0EB1C103K	T	64/37.5
C1307	4030016930	S.CER ECJ0EB1A104K	T	48.4/12.9
C1308	4030016930	S.CER ECJ0EB1A104K	T	63.1/13.1
C1309	4030016930	S.CER ECJ0EB1A104K	T	46.1/37.2
C1310	4030016930	S.CER ECJ0EB1A104K	T	67/30.9

M.=Mounted side (T: Mounted on the Top side, B: Mounted on the Bottom side)
S.=Surface mount

[LOGIC UNIT]

REF NO.	ORDER NO.	DESCRIPTION	M.	H/V LOCATION
C1311	4030016930	S.CER ECJ0EB1A104K	T	67/25.7
C1312	4030017620	S.CER ECJ0EC1H100C	T	67.4/29.1
C1313	4030017620	S.CER ECJ0EC1H100C	T	67.4/28.2
C1314	4030016930	S.CER ECJ0EB1A104K	T	79/9.8
C1315	4030017030	S.CER ECJ0EB1A273K	T	83.3/10.8
C1316	4030016930	S.CER ECJ0EB1A104K	B	75.9/2.3
C1317	4030018960	S.CER C3216 JB 1C 106MT-N	B	84.4/3
C1319	4030018960	S.CER C3216 JB 1C 106MT-N	B	16.8/6.6
C2016	4030016930	S.CER ECJ0EB1A104K	B	37.7/30.2
C2017	4030016930	S.CER ECJ0EB1A104K	B	37.7/31.3
C2101	4030016930	S.CER ECJ0EB1A104K	T	44/43
C2102	4030016930	S.CER ECJ0EB1A104K	T	45.8/43
C2202	4030016930	S.CER ECJ0EB1A104K	T	27/16.5
C2204	4030016930	S.CER ECJ0EB1A104K	T	26.5/19.2
C2205	4030016930	S.CER ECJ0EB1A104K	T	30.2/19.7
C2206	4030016930	S.CER ECJ0EB1A104K	T	26.6/11.1
C2207	4030016930	S.CER ECJ0EB1A104K	T	27.7/19.7
C2208	4030016930	S.CER ECJ0EB1A104K	T	21.5/23.4
C2209	4030016930	S.CER ECJ0EB1A104K	T	29.8/17.6
C2210	4030016930	S.CER ECJ0EB1A104K	T	26.6/17.8
C2211	4030016930	S.CER ECJ0EB1A104K	T	32.4/11.1
C2212	4030016930	S.CER ECJ0EB1A104K	T	35.2/14.6
C2213	4030016930	S.CER ECJ0EB1A104K	T	29.3/16.4
C2214	4030016930	S.CER ECJ0EB1A104K	T	35.2/17.3
C2215	4030016930	S.CER ECJ0EB1A104K	T	29.3/11.1
C2217	4030016930	S.CER ECJ0EB1A104K	T	29.8/18.5
C2218	4030016930	S.CER ECJ0EB1A104K	T	26.5/20.1
C2219	4030016930	S.CER ECJ0EB1A104K	T	30.2/16.4
C2220	4030016930	S.CER ECJ0EB1A104K	T	26.1/16.5
C2221	4030016930	S.CER ECJ0EB1A104K	T	27.9/16.5
C2222	4030016930	S.CER ECJ0EB1A104K	T	29.3/19.7
J651	6510024810	S.CNR AXK6S60635P	B	71/24.9
J701	6510022070	S.CNR AXK6S30635P	B	10.9/20.4
J1201	6510018890	S.CNR 52559-1390	B	77.5/38.2
J2101	6510020130	S.CNR AXN810535P	T	52.4/42.9
BT1301	3020000330	LTM ML920S/F9D		
EP2	6910012350	S.BEA MMZ1608Y 102BT	T	18.8/38.2
EP51	6910012350	S.BEA MMZ1608Y 102BT	B	18.1/29.7
EP201	6910014730	S.BEA MPZ2012S331A-T	T	13.3/40.6
EP301	6910012350	S.BEA MMZ1608Y 102BT	T	19.1/40
EP701	6910012350	S.BEA MMZ1608Y 102BT	B	5.6/15
EP2002	6910012350	S.BEA MMZ1608Y 102BT	B	38.2/28
EP2202	6910012350	S.BEA MMZ1608Y 102BT	T	19.1/22
EP2205	6910014730	S.BEA MPZ2012S331A-T	T	18.4/17.7
EP2217	6910015970	S.BEA MMZ1608B 301CT-AS	B	20.9/16.1

[DDS UNIT]

REF NO.	ORDER NO.	DESCRIPTION	M.	H/V LOCATION
IC51	1190001811	S.IC AD9833BRMZ	T	33.8/7
IC52	1130012780	S.IC SN74AHC2G04HDCCTR	T	45/5.6
IC61	1130012610	S.IC SN74AHC1GU04DCKR	T	37.5/7.5
IC62	1130012850	S.IC SN74LVC3G34DCUR	T	51.3/24.7
IC251	1180002321	S.REG TK11218CMCL-G	B	29.5/16.2
IC301	1190002101	S.IC SN65LVDS391D	T	37.5/28.2
IC401	1110004080	S.IC μPC2709T-E3	T	50.1/47
IC451	1110006430	S.IC μPC1678GV-E1-A	T	34.1/50.2
IC801	1110006430	S.IC μPC1678GV-E1-A	T	18/13.7
IC901	1130012720	S.IC CD74HC4094PWR	T	5.4/64.7
Q1	1530002381	S.TR 2SC4215-Y (YE85R ,F)	T	20.4/3.1
Q101	1530002561	S.TR 2SC4403-3-TL-E	T	26.5/6.4
Q151	1530003151	S.TR 2SC4673D-TD-E	T	41.4/13.7
Q201	1530003431	S.TR 2SC5226-4-TL-E	T	43.4/19.4
Q211	1530003431	S.TR 2SC5226-4-TL-E	B	43.5/15.2
Q301	1590000680	S.TR DTC114EUA T106	B	45.4/32.2
Q901	1590003530	S.TR BCR08PN	T	4/58.7
Q902	1590003530	S.TR BCR08PN	T	4.1/55.1
Q903	1590003530	S.TR BCR08PN	T	7.2/55.1
Q904	1590003530	S.TR BCR08PN	T	7.2/58.7
Q905	1590003530	S.TR BCR08PN	T	4.1/70.7
Q906	1590003530	S.TR BCR08PN	T	4.1/74.2
Q907	1590003530	S.TR BCR08PN	T	7.1/70.7
Q908	1590003530	S.TR BCR08PN	T	7.1/74.2
Q1101	1530002060	S.TR 2SC4081 T106 R	T	40.9/53.9
Q1102	1540000451	S.TR 2SD1623T-TD-E	T	45.5/54.3
D301	1750000620	S.DIO MA717WK (TX)	B	44.8/35.9
D341	1790001621	S.DIO 1SV308 (TPL3, F)	B	45.2/39.7
D451	1750000581	S.DIO 1SV307 (TPH3, F)	T	44.2/47.7
D452	1750000581	S.DIO 1SV307 (TPH3, F)	T	44/44.8
D453	1790001621	S.DIO 1SV308 (TPL3, F)	T	43.3/36.6
D454	1750000581	S.DIO 1SV307 (TPH3, F)	T	38.3/48.3
D456	1750000620	S.DIO MA717WK (TX)	B	35.1/42.8
D458	1750000581	S.DIO 1SV307 (TPH3, F)	T	33.8/45.6
D459	1750000581	S.DIO 1SV307 (TPH3, F)	T	31.3/38.8
D471	1750000620	S.DIO MA717WK (TX)	T	33.2/36.7
D501	1750000581	S.DIO 1SV307 (TPH3, F)	B	26.2/42.6
D502	1750000581	S.DIO 1SV307 (TPH3, F)	T	3/50.6
D551	1750000581	S.DIO 1SV307 (TPH3, F)	T	25.9/45.1
D552	1750000581	S.DIO 1SV307 (TPH3, F)	T	2.9/45.3
D601	1750000581	S.DIO 1SV307 (TPH3, F)	T	27.2/39.9
D602	1750000581	S.DIO 1SV307 (TPH3, F)	T	2.9/40.1
D651	1750000581	S.DIO 1SV307 (TPH3, F)	T	27.2/34.8
D652	1750000581	S.DIO 1SV307 (TPH3, F)	T	2.9/34.9
D701	1750000581	S.DIO 1SV307 (TPH3, F)	T	27.2/29.5
D702	1750000581	S.DIO 1SV307 (TPH3, F)	T	2.9/29.7
D751	1750000581	S.DIO 1SV307 (TPH3, F)	T	27/24.8
D752	1750000581	S.DIO 1SV307 (TPH3, F)	T	2.9/24.6
D801	1750000581	S.DIO 1SV307 (TPH3, F)	T	28.3/21.6
D802	1750000581	S.DIO 1SV307 (TPH3, F)	T	2.9/19.3
D1101	1750000301	S.DIO 1SS302 (TE85R, F)	T	40.9/57.7
D1102	1160000080	S.DIO DAP202K T146	B	27.9/63
FI101	2010002660	S.XTL FL-391 (124.032 MHz)	T	29.3/10.7
FI201	2040001860	S.SAW NSVS776	T	34.5/16.5
X1	6050012160	S.XTL CR-788 (24.8064 MHz)	T	14.2/3.9
L1	6200002641	S.COL NLV25T-R15J	T	26/3.7
L51	6200005011	S.COL NLV25T-100J	B	35.6/4.2
L52	6200005011	S.COL NLV25T-100J	B	38.8/3.8
L53	6200003241	S.COL NLV32T-221J	B	43.4/8.7
L101	6200003540	S.COL MLF1608D R22K-T	T	24.2/8.8
L105	6200004730	S.COL MLF1608A 1R2K-T	T	23.7/5.2
L151	6200004470	S.COL MLF1608D R12K-T	T	44.7/12.8
L153	6200004150	S.COL MLF1608D 47NM-T	T	46.9/15.7
L201	6200004150	S.COL MLF1608D 47NM-T	T	44.5/21.5
L202	6200005661	S.COL ELJRE 10NGFA	B	37.5/12.4
L204	6200003540	S.COL MLF1608D R22K-T	T	41.5/19.3
L205	6200005711	S.COL ELJRE 27NGFA	B	47.1/21.7
L206	6200005701	S.COL ELJRE 22NGFA	B	46.2/20.4
L210	6200005701	S.COL ELJRE 22NGFA	B	47/19.1
L212	6200002581	S.COL NLV25T-033J	B	41.9/12.8
L213	6200005681	S.COL ELJRE 15NGFA	B	40.1/17.8
L301	6140002810	S.COL LR-317	T	48.5/30
L302	6140002810	S.COL LR-317	T	48.7/38.9
L303	6200004150	S.COL MLF1608D 47NM-T	B	41.9/35.7
L304	6200003960	S.COL MLF1608A 1R0K-T	T	48.9/33.2
L321	6200011370	S.COL ELJNJ R10J	T	50.4/34.7
L322	6200011370	S.COL ELJNJ R10J	T	47.8/34.7
L323	6200010860	S.COL C2520C-R10G-A	T	53.7/30.6
L331	6200011540	S.COL ELJQE 47NJ	T	47.6/43.1
L332	6200011540	S.COL ELJQE 47NJ	T	50.2/43.1
L341	6200004470	S.COL MLF1608D R12K-T	B	41.1/37

M.=Mounted side (T: Mounted on the Top side, B: Mounted on the Bottom side)
S.=Surface mount

[DDS UNIT]

REF NO.	ORDER NO.	DESCRIPTION	M.	H/V LOCATION
L401	6200001981	S.COL NLV25T-1R0J	T	50.2/49.9
L411	6200011700	S.COL ELJQE 39NJ	T	47.3/48.3
L456	6140002810	S.COL LR-317	T	40.1/44.9
L458	6200011540	S.COL ELJQE 47NJ	B	37.5/42.1
L461	6200011570	S.COL ELJQE 10NJ	B	39.3/41.7
L464	6200002631	S.COL NLV25T-R10J	T	28.8/50.6
L465	6200004470	S.COL MLF1608R R12K-T	T	42.9/39.5
L466	6200011710	S.COL ELJQE 33NJ	T	39.1/41.1
L467	6200011560	S.COL ELJQE 12NJ	T	27.7/47.1
L468	6200011350	S.COL ELJQE 18NJ	T	26.1/48.3
L469	6200011360	S.COL ELJQE 15NJ	T	33.6/41.3
L471	6140002810	S.COL LR-317	T	38.7/37.2
L472	6200011540	S.COL ELJQE 47NJ	T	33.4/39.3
L473	6200011340	S.COL ERJQE 22NJ	T	35.5/40.4
L501	6200002611	S.COL NLV25T-R47J	B	21.7/43.6
L502	6200002631	S.COL NLV25T-R10J	B	18.1/46.7
L503	6200002431	S.COL NLV25T-082J	B	15/46.4
L504	6200002411	S.COL NLV25T-056J	T	14.3/49.4
L505	6200002421	S.COL NLV25T-068J	T	11.2/50.2
L506	6200002421	S.COL NLV25T-068J	T	8.2/49.7
L507	6200002611	S.COL NLV25T-R47J	T	3.8/48.2
L551	6200002611	S.COL NLV25T-R47J	T	24.9/42.6
L552	6200002421	S.COL NLV25T-068J	T	20.3/43.3
L553	6200002411	S.COL NLV25T-056J	T	17.6/42.9
L554	6200002601	S.COL NLV25T-047J	T	14.7/45
L555	6200002601	S.COL NLV25T-047J	T	12/44.3
L556	6200002581	S.COL NLV25T-033J	T	9.2/45
L557	6200002611	S.COL NLV25T-R47J	T	4.5/42.8
L601	6200002611	S.COL NLV25T-R47J	T	25.3/37.4
L602	6200002601	S.COL NLV25T-047J	T	22.6/39.6
L603	6200002591	S.COL NLV25T-039J	T	17.9/39.1
L604	6200003891	S.COL NLV25T-027J	T	16.8/39.9
L605	6200002601	S.COL NLV25T-047J	T	14.1/37.9
L606	6200002601	S.COL NLV25T-047J	T	11.4/37.7
L607	6200002421	S.COL NLV25T-068J	T	8.6/37.7
L608	6200002601	S.COL NLV25T-047J	T	5.1/37.7
L651	6200002611	S.COL NLV25T-R47J	T	26/32.2
L652	6200002591	S.COL NLV25T-039J	T	22.4/32.5
L653	6200002591	S.COL NLV25T-039J	T	19.6/32.8
L654	6200002591	S.COL NLV25T-039J	T	14/34.6
L655	6200002591	S.COL NLV25T-039J	T	11.2/33.9
L656	6200002601	S.COL NLV25T-047J	T	16.7/32.5
L657	6200002581	S.COL NLV25T-033J	T	7.9/34.6
L658	6200002611	S.COL NLV25T-R47J	T	5.2/32.6
L701	6200002611	S.COL NLV25T-R47J	T	26/26.9
L702	6200002581	S.COL NLV25T-033J	T	22.9/29.2
L703	6200002581	S.COL NLV25T-033J	T	20.2/28.7
L704	6200003891	S.COL NLV25T-027J	T	17.3/29.5
L705	6200002591	S.COL NLV25T-039J	T	14.6/27.3
L706	6200002581	S.COL NLV25T-033J	T	11.8/27.3
L707	6200002581	S.COL NLV25T-033J	T	9.1/27.2
L708	6200002611	S.COL NLV25T-R47J	T	4.5/27.2
L751	6200002611	S.COL NLV25T-R47J	T	25.9/22
L752	6200003881	S.COL NLV25T-022J	T	22.4/22.4
L753	6200003891	S.COL NLV25T-027J	T	19.7/22.2
L754	6200002581	S.COL NLV25T-033J	T	16.9/22.5
L755	6200003891	S.COL NLV25T-027J	T	14.2/24.2
L756	6200003891	S.COL NLV25T-027J	T	11.4/23.5
L757	6200003881	S.COL NLV25T-022J	T	8.7/24.2
L758	6200002611	S.COL NLV25T-R47J	T	3.9/22.2
L801	6200002181	S.COL NLV25T-R12J	T	28.3/17.5
L803	6200005711	S.COL ELJRE 27NGFA	T	26.3/17.6
L804	6200011350	S.COL ELJQE 18NJ	T	25/15.6
L805	6200011360	S.COL ELJQE 15NJ	T	23.1/14.9
L806	6200005641	S.COL ELJRE 6N8ZFA	T	21.5/19
L807	6200011560	S.COL ELJQE 12NJ	T	18.7/18.2
L808	6200004720	S.COL MLF1608R R10K-T	T	17.9/10
L812	6200005711	S.COL ELJRE 27NGFA	T	14.8/14.4
L813	6200011350	S.COL ELJQE 18NJ	T	15.7/17.2
L814	6200011360	S.COL ELJQE 15NJ	T	13.8/18.2
L815	6200005641	S.COL ELJRE 6N8ZFA	T	10.1/18
L816	6200011560	S.COL ELJQE 12NJ	T	6.6/17.8
L818	6200002181	S.COL NLV25T-R12J	T	4.6/17
L851	6200002181	S.COL NLV25T-R12J	B	26.8/30.6
L852	6200002611	S.COL NLV25T-R47J	B	26.4/34.1
L853	6200002181	S.COL NLV25T-R12J	B	3.4/22.8
L854	6200002611	S.COL NLV25T-R47J	B	5.4/26
L901	6200007420	S.COL ELJFC 101K-F	B	3.7/65.9
L953	6200002041	S.COL NLV25T-101J	B	56.4/44.6
L954	6200002041	S.COL NLV25T-101J	B	55.7/42.1
L955	6200002041	S.COL NLV25T-101J	B	55.9/39.6
L956	6200002041	S.COL NLV25T-101J	B	56.1/37.1
L957	6200002041	S.COL NLV25T-101J	B	55.9/34.6
L959	6200011300	S.COL EXCML16A 270U	T	54.9/34.3
L960	6200002041	S.COL NLV25T-101J	B	56.5/30.8
L962	6200011300	S.COL EXCML16A 270U	B	59.2/32.2
L963	6200011300	S.COL EXCML16A 270U	B	60.4/32.2
L1001	6200003241	S.COL NLV32T-221J	B	53.7/50.8
L1002	6200003241	S.COL NLV32T-221J	B	47.9/55
L1103	6200002041	S.COL NLV25T-101J	B	42.2/61.2
L1105	6200002041	S.COL NLV25T-101J	B	40.8/71.8

[DDS UNIT]

REF NO.	ORDER NO.	DESCRIPTION	M.	H/V LOCATION
L1106	6200002041	S.COL NLV25T-101J	T	36.4/62.3
L1107	6200002041	S.COL NLV25T-101J	B	34.9/74.7
L1110	6200002041	S.COL NLV25T-101J	T	32.4/62.3
L1111	6200002041	S.COL NLV25T-101J	B	26.1/69.8
L1112	6200002041	S.COL NLV25T-101J	T	29.9/62.3
L1152	6200003590	S.COL EXCCL3225U1	T	48.3/69.2
L1153	6200002041	S.COL NLV25T-101J	T	45.5/69.3
L1154	6200002041	S.COL NLV25T-101J	T	53.6/69.2
R2	7030007290	S.RES ERJ2GEJ 222 X (2.2 kΩ)	T	19.1/4.5
R3	7030005040	S.RES ERJ2GEJ 472 X (4.7 kΩ)	T	18.6/1.8
R4	7030004990	S.RES ERJ2GEJ 221 X (220 Ω)	T	22.2/2.6
R5	7030004980	S.RES ERJ2GEJ 101 X (100 Ω)	T	21.1/6.7
R8	7030003630	S.RES ERJ3GEYJ 393 V (39 kΩ)	B	13.6/7.1
R9	7030003610	S.RES ERJ3GEYJ 273 V (27 kΩ)	B	13.6/9.7
R10	7030005220	S.RES ERJ2GEJ 223 X (22 kΩ)	T	8/3.2
R11	7030010040	S.RES ERJ2GEJ-JPW	T	9.2/3.7
R51	7030005120	S.RES ERJ2GEJ 102 X (1 kΩ)	T	34.3/8.6
R52	7030005120	S.RES ERJ2GEJ 102 X (1 kΩ)	T	46.1/2.3
R53	7030005120	S.RES ERJ2GEJ 102 X (1 kΩ)	T	42.8/3.5
R54	7030005120	S.RES ERJ2GEJ 102 X (1 kΩ)	T	42.8/2.6
R55	7030008280	S.RES ERJ2GEJ 271 X (270 Ω)	T	34.7/7
R56	7030010090	S.RES ERJ2GEJ 180 X (18 Ω)	T	33.4/8.6
R57	7030008280	S.RES ERJ2GEJ 271 X (270 Ω)	T	32.5/8.6
R61	7030005050	S.RES ERJ2GEJ 103 X (10 kΩ)	T	39.3/8.1
R62	7030005530	S.RES ERJ2GEJ 100 X (10 Ω)	T	49.3/23.1
R101	7030005000	S.RES ERJ2GEJ 471 X (470 Ω)	T	25.2/7.8
R102	7030004980	S.RES ERJ2GEJ 101 X (100 Ω)	T	22.7/7.8
R103	7030005570	S.RES ERJ2GEJ 820 X (82 Ω)	T	31.8/11.1
R104	7030004980	S.RES ERJ2GEJ 101 X (100 Ω)	T	33/11.5
R105	7030005570	S.RES ERJ2GEJ 820 X (82 Ω)	T	34.2/11.1
R106	7030005100	S.RES ERJ2GEJ 154 X (150 kΩ)	T	23.9/7.4
R121	7030005040	S.RES ERJ2GEJ 472 X (4.7 kΩ)	T	38.5/11.1
R150	7030005570	S.RES ERJ2GEJ 820 X (82 Ω)	T	45.8/10.7
R151	7030004980	S.RES ERJ2GEJ 101 X (100 Ω)	T	44.9/10.7
R154	7030005050	S.RES ERJ2GEJ 103 X (10 kΩ)	T	41.4/10.6
R155	7030005530	S.RES ERJ2GEJ 100 X (10 Ω)	T	46.3/12.6
R157	7030007270	S.RES ERJ2GEJ 151 X (150 Ω)	T	48.8/18.2
R158	7030009200	S.RES ERJ2GEJ 390 X (39 Ω)	T	48/16.7
R159	7030007270	S.RES ERJ2GEJ 151 X (150 Ω)	T	47.9/18.2
R160	7030005300	S.RES ERJ2GEJ 150 X (15 Ω)	T	44.2/15.9
R161	7030005300	S.RES ERJ2GEJ 150 X (15 Ω)	T	45.1/15.9
R162	7030005300	S.RES ERJ2GEJ 150 X (15 Ω)	T	45/14.6
R201	7030005530	S.RES ERJ2GEJ 100 X (10 Ω)	T	45.8/22
R202	7030000700	S.RES MCR10EZJH 470 kΩ	T	45.6/18.8
R211	7030003400	S.RES ERJ3GEYJ 471 V (470 Ω)	B	37.3/17.8
R212	7030003440	S.RES ERJ3GEYJ 102 V (1 kΩ)	B	40.8/16.2
R213	7030003200	S.RES ERJ3GEYJ 100 V (10 Ω)	B	44.5/11.4
R214	7030003280	S.RES ERJ3GEYJ 470 V (47 Ω)	B	46.8/16.3
R301	7030005120	S.RES ERJ2GEJ 102 X (1 kΩ)	T	34.2/22.2
R303	7030010040	S.RES ERJ2GEJ-JPW	T	40/22.2
R304	7030005120	S.RES ERJ2GEJ 102 X (1 kΩ)	T	42/24.6
R305	7030005710	S.RES ERJ2GEJ 121 X (120 Ω)	T	44.1/28.9
R306	7030005120	S.RES ERJ2GEJ 102 X (1 kΩ)	T	31.5/25.6
R309	7030005120	S.RES ERJ2GEJ 102 X (1 kΩ)	T	31.2/29.4
R310	7030005120	S.RES ERJ2GEJ 102 X (1 kΩ)	T	31.2/30.5
R311	7030005120	S.RES ERJ2GEJ 102 X (1 kΩ)	T	31.2/31.5
R312	7030010040	S.RES ERJ2GEJ-JPW	T	32.9/31.7
R313	7030005710	S.RES ERJ2GEJ 121 X (120 Ω)	T	43.2/28.5
R314	7030009140	S.RES ERJ2GEJ 272 X (2.7 kΩ)	T	43/31.8
R315	7030005120	S.RES ERJ2GEJ 102 X (1 kΩ)	T	33.5/32.6
R316	7030005050	S.RES ERJ2GEJ 103 X (10 kΩ)	T	34.6/33.8
R317	7030007570	S.RES ERJ2GEJ 122 X (1.2 kΩ)	T	43.9/31.8
R341	7030003440	S.RES ERJ3GEYJ 102 V (1 kΩ)	B	44.3/38.3
R342	7030003440	S.RES ERJ3GEYJ 102 V (1 kΩ)	B	45.9/41.2
R451	7030005120	S.RES ERJ2GEJ 102 X (1 kΩ)	T	44.5/46.2
R453	7030010090	S.RES ERJ2GEJ 180 X (18 Ω)	T	34.1/47.4
R454	7030008280	S.RES ERJ2GEJ 271 X (270 Ω)	T	32.9/47
R455	7030008280	S.RES ERJ2GEJ 271 X (270 Ω)	T	32.9/47.9
R456	7030010040	S.RES ERJ2GEJ-JPW	T	34.9/52.4
R457	7030005120	S.RES ERJ2GEJ 102 X (1 kΩ)	T	38.1/49.7
R458	7030004990	S.RES ERJ2GEJ 221 X (220 Ω)	T	31.6/43.6
R459	7030005090	S.RES ERJ2GEJ 104 X (100 kΩ)	T	42.1/50
R460	7030003680	S.RES ERJ3GEYJ 104 V (100 kΩ)	T	30.7/41
R461	7030005090	S.RES ERJ2GEJ 104 X (100 kΩ)	T	29.6/39.1
R462	7030003860	S.RES ERJ3GE JPW V	T	45/43.3
R463	7030003400	S.RES ERJ3GEYJ 471 V (470 Ω)	T	33.3/44
R464	7030004980	S.RES ERJ2GEJ 101 X (100 Ω)	T	40.8/47.9
R465	7030005570	S.RES ERJ2GEJ 820 X (82 Ω)	T	40.3/50
R467	7030005570	S.RES ERJ2GEJ 820 X (82 Ω)	T	40.8/48.8
R468	7030005570	S.RES ERJ2GEJ 820 X (82 Ω)	T	41.2/50
R469	7030003320	S.RES ERJ3GEYJ 101 V (100 Ω)	B	37.7/39.9
R471	7030005000	S.RES ERJ2GEJ 471 X (470 Ω)	T	41.6/37.7
R472	7030004990	S.RES ERJ2GEJ 221 X (220 Ω)	T	30.3/43.3
R473	7030007270	S.RES ERJ2GEJ 151 X (150 Ω)	T	31.7/34.6
R474	7030009200	S.RES ERJ2GEJ 390 X (39 Ω)	T	31.3/35.8
R475	7030007270	S.RES ERJ2GEJ 151 X (150 Ω)	T	30.1/35.3
R476	7030005000	S.RES ERJ2GEJ 471 X (470 Ω)	T	29.9/37.9
R477	7030003320	S.RES ERJ3GEYJ 101 V (100 Ω)	B	37.3/38.6
R501	7030003390	S.RES ERJ3GEYJ 391 V (390 Ω)	B	21/46.1

M.=Mounted side (T: Mounted on the Top side, B: Mounted on the Bottom side)
S.=Surface mount

[DDS UNIT]

REF NO.	ORDER NO.	DESCRIPTION	M.	H/V LOCATION
R502	7030009280	S.RES ERJ2GEJ 391 X (390 Ω)	T	5.8/46.8
R503	7030005090	S.RES ERJ2GEJ 104 X (100 kΩ)	T	14.3/46.8
R505	7030005570	S.RES ERJ2GEJ 820 X (82 Ω)	T	6.5/48.6
R506	7030005570	S.RES ERJ2GEJ 820 X (82 Ω)	T	6/49.8
R507	7030005570	S.RES ERJ2GEJ 820 X (82 Ω)	T	5.6/48.6
R551	7030009280	S.RES ERJ2GEJ 391 X (390 Ω)	T	23.1/42
R552	7030009280	S.RES ERJ2GEJ 391 X (390 Ω)	T	6.3/42
R553	7030005090	S.RES ERJ2GEJ 104 X (100 kΩ)	T	10.1/41.6
R554	7030009200	S.RES ERJ2GEJ 390 X (39 Ω)	T	6.4/45.7
R555	7030007270	S.RES ERJ2GEJ 151 X (150 Ω)	T	7.1/44.4
R556	7030007270	S.RES ERJ2GEJ 151 X (150 Ω)	T	6.2/44.3
R601	7030008280	S.RES ERJ2GEJ 271 X (270 Ω)	T	23.2/36.1
R602	7030009280	S.RES ERJ2GEJ 391 X (390 Ω)	T	6.8/36.6
R603	7030005090	S.RES ERJ2GEJ 104 X (100 kΩ)	T	19.6/36.4
R604	7030004980	S.RES ERJ2GEJ 101 X (100 Ω)	T	20.8/36.1
R651	7030009280	S.RES ERJ2GEJ 391 X (390 Ω)	T	24.2/31.2
R652	7030009280	S.RES ERJ2GEJ 391 X (390 Ω)	T	6.3/30.5
R653	7030005090	S.RES ERJ2GEJ 104 X (100 kΩ)	T	9.9/31.2
R701	7030009280	S.RES ERJ2GEJ 391 X (390 Ω)	T	23.8/25.8
R702	7030009280	S.RES ERJ2GEJ 391 X (390 Ω)	T	6.5/26
R703	7030005090	S.RES ERJ2GEJ 104 X (100 kΩ)	T	19.9/26
R704	7030004980	S.RES ERJ2GEJ 101 X (100 Ω)	T	7.2/27.2
R705	7030005580	S.RES ERJ2GEJ 560 X (56 Ω)	T	6.7/28.4
R706	7030004980	S.RES ERJ2GEJ 101 X (100 Ω)	T	6.3/27.2
R751	7030009280	S.RES ERJ2GEJ 391 X (390 Ω)	T	24.2/21
R752	7030009280	S.RES ERJ2GEJ 391 X (390 Ω)	T	5.9/20.8
R753	7030005090	S.RES ERJ2GEJ 104 X (100 kΩ)	T	10.3/20.8
R755	7030004980	S.RES ERJ2GEJ 101 X (100 Ω)	T	6.6/22.6
R756	7030005580	S.RES ERJ2GEJ 560 X (56 Ω)	T	6.6/24.2
R757	7030004980	S.RES ERJ2GEJ 101 X (100 Ω)	T	5.7/23.3
R801	7030008280	S.RES ERJ2GEJ 271 X (270 Ω)	T	27.2/14.5
R805	7030005570	S.RES ERJ2GEJ 820 X (82 Ω)	T	13.9/10.3
R806	7030005570	S.RES ERJ2GEJ 820 X (82 Ω)	T	14.2/11.7
R807	7030005570	S.RES ERJ2GEJ 820 X (82 Ω)	T	13/11.3
R808	7030003390	S.RES ERJ3GEJY 391 V (390 Ω)	B	3.6/17.9
R810	7030005090	S.RES ERJ2GEJ 104 X (100 kΩ)	T	27.2/15.4
R841	7030005710	S.RES ERJ2GEJ 121 X (120 Ω)	T	21.2/12.5
R851	7030009280	S.RES ERJ2GEJ 391 X (390 Ω)	T	27.1/37.3
R852	7030008280	S.RES ERJ2GEJ 271 X (270 Ω)	T	5.7/13.7
R853	7030010090	S.RES ERJ2GEJ 180 X (18 Ω)	T	6.9/14
R854	7030008280	S.RES ERJ2GEJ 271 X (270 Ω)	T	6.9/13
R855	7030003390	S.RES ERJ3GEJY 391 V (390 Ω)	B	5.5/29.5
R901	7030005120	S.RES ERJ2GEJ 102 X (1 kΩ)	T	2.1/62.6
R902	7030005120	S.RES ERJ2GEJ 102 X (1 kΩ)	T	2.2/60.9
R903	7030005120	S.RES ERJ2GEJ 102 X (1 kΩ)	T	2.2/58.7
R951	7030003360	S.RES ERJ3GEJY 221 V (220 Ω)	B	59.2/6.9
R952	7030004990	S.RES ERJ2GEJ 221 X (220 Ω)	T	55.1/9.2
R953	7030003360	S.RES ERJ3GEJY 221 V (220 Ω)	B	59.5/3.3
R954	7030004990	S.RES ERJ2GEJ 221 X (220 Ω)	T	54.5/8.3
R955	7030004990	S.RES ERJ2GEJ 221 X (220 Ω)	T	55.1/7.3
R956	7030003360	S.RES ERJ3GEJY 221 V (220 Ω)	B	59.2/4.9
R957	7030003360	S.RES ERJ3GEJY 221 V (220 Ω)	B	56.6/5
R958	7030004990	S.RES ERJ2GEJ 221 X (220 Ω)	T	47.2/6.1
R959	7030003360	S.RES ERJ3GEJY 221 V (220 Ω)	B	57.9/5.1
R960	7030003280	S.RES ERJ3GEJY 470 V (47 Ω)	B	57.5/49
R961	7030004990	S.RES ERJ2GEJ 221 X (220 Ω)	T	54.6/11.6
R962	7030003860	S.RES ERJ3GE JPW V	T	51.3/21
R1051	7030003860	S.RES ERJ3GE JPW V	B	10.8/73
R1101	7030005120	S.RES ERJ2GEJ 102 X (1 kΩ)	T	40.5/52.1
R1102	7030005050	S.RES ERJ2GEJ 103 X (10 kΩ)	T	42.1/52.1
R1103	7030004980	S.RES ERJ2GEJ 101 X (100 Ω)	T	39.3/63.4
R1104	7030005050	S.RES ERJ2GEJ 103 X (10 kΩ)	T	44.2/51.2
R1105	7030004980	S.RES ERJ2GEJ 101 X (100 Ω)	T	38.7/60.9
R1106	7030007290	S.RES ERJ2GEJ 222 X (2.2 kΩ)	T	31.8/59.6
R1107	7030007290	S.RES ERJ2GEJ 222 X (2.2 kΩ)	T	28.1/59.6
R1108	7030005240	S.RES ERJ2GEJ 473 X (47 kΩ)	T	46.9/8.3
R1109	7030005240	S.RES ERJ2GEJ 473 X (47 kΩ)	T	47.8/8
C1	4030016950	S.CER ECJ0EB1A473K	T	18.6/5.7
C2	4030017780	S.CER ECJ0EB1E472K	T	20.9/5
C3	4030017510	S.CER ECJ0EB1H680J	T	24.8/1.7
C4	4030017780	S.CER ECJ0EB1E472K	T	22.3/4.6
C5	4030017680	S.CER ECJ0EB1H820J	T	26/2
C6	4030017510	S.CER ECJ0EB1H680J	T	27.2/1.7
C7	4030016930	S.CER ECJ0EB1A104K	T	8/4.1
C51	4030017780	S.CER ECJ0EB1E472K	T	33.8/7
C52	4030017780	S.CER ECJ0EB1E472K	T	36.1/5.3
C53	4030017780	S.CER ECJ0EB1E472K	T	35.2/8.6
C54	4030016930	S.CER ECJ0EB1A104K	T	34.9/4.4
C55	4510008580	S.ELE EEE0J4470SR	T	30.6/3.9
C56	4030016930	S.CER ECJ0EB1A104K	T	34.9/2.8
C57	4030016930	S.CER ECJ0EB1A104K	T	42.8/5
C58	4030016930	S.CER ECJ0EB1A104K	T	41.5/9
C59	4030017720	S.CER ECJ0EB1H331K	T	41.9/6.6
C60	4030017690	S.CER ECJ0EB1H121J	T	42.2/7.8
C61	4030017720	S.CER ECJ0EB1H331K	T	42.8/6.6
C62	4030016930	S.CER ECJ0EB1A104K	T	35.6/6.5
C63	4030016930	S.CER ECJ0EB1A104K	T	49.3/22.2
C101	4030017580	S.CER ECJ0EB1H060C	T	26.4/8.7
C102	4030017660	S.CER ECJ0EB1H330J	T	23.1/2.6

[DDS UNIT]

REF NO.	ORDER NO.	DESCRIPTION	M.	H/V LOCATION
C104	4030017780	S.CER ECJ0EB1E472K	T	21.1/7.6
C105	4030017460	S.CER ECJ0EB1E102K	T	24.8/6.5
C120	4030017780	S.CER ECJ0EB1E472K	T	37.3/11.8
C126	4030017780	S.CER ECJ0EB1E472K	T	22.7/6.9
C150	4030017780	S.CER ECJ0EB1E472K	T	44/10.7
C151	4030017780	S.CER ECJ0EB1E472K	T	46.3/13.6
C152	4030017640	S.CER ECJ0EB1H150J	T	43.3/16
C154	4030017660	S.CER ECJ0EB1H330J	T	46.6/14.6
C155	4030017600	S.CER ECJ0EB1H080C	T	46.4/16.7
C156	4030017660	S.CER ECJ0EB1H330J	T	47/18.2
C157	4030007090	S.CER C1608 CH 1H 470J-T	B	53/16
C202	4030017590	S.CER ECJ0EB1H070C	T	43.8/17.2
C203	4030007060	S.CER C1608 CH 1H 270J-T	B	37.8/15.9
C204	4030016930	S.CER ECJ0EB1A104K	T	35.1/20.1
C206	4030017560	S.CER ECJ0EB1H2R5B	T	43.4/21.7
C207	4030007110	S.CER C1608 CH 1H 680J-T	B	44/21.7
C208	4030009910	S.CER C1608 CH 1H 040B-T	B	40.9/21.7
C209	4030007060	S.CER C1608 CH 1H 270J-T	B	43.1/20.4
C210	4030009910	S.CER C1608 CH 1H 040B-T	B	40.8/19.1
C211	4030017460	S.CER ECJ0EB1E102K	T	42.2/17.6
C216	4030017780	S.CER ECJ0EB1E472K	T	46.3/20.8
C217	4030007120	S.CER C1608 CH 1H 820J-T	B	43.9/19.1
C218	4030017770	S.CER C1608 CH 1H 060B-T	B	43.2/17.8
C219	4030007100	S.CER C1608 CH 1H 100D-T	B	46.2/17.8
C221	4030006880	S.CER C1608 JB 1H 472K-T	B	46/15
C222	4030009910	S.CER C1608 CH 1H 040B-T	B	40.7/14.7
C223	4030006880	S.CER C1608 JB 1H 472K-T	B	46/13.5
C224	4030018630	S.CER C2012 CH 1H 472J-T	B	39.2/11.4
C251	4030011600	S.CER C1608 JB 1E 104K-T	B	27.6/12.2
C252	4030011600	S.CER C1608 JB 1E 104K-T	B	28.7/23.5
C253	4550007090	S.TAN TEESVA 1A 226M8R	B	29.6/21.7
C254	4030011600	S.CER C1608 JB 1E 104K-T	B	29.2/12.2
C255	4550007090	S.TAN TEESVA 1A 226M8R	B	29.5/19.3
C301	4030016930	S.CER ECJ0EB1A104K	T	35.1/22.2
C302	4030016930	S.CER ECJ0EB1A104K	T	36.2/22.2
C303	4030016930	S.CER ECJ0EB1A104K	T	37.3/22.2
C304	4030016930	S.CER ECJ0EB1A104K	T	38.2/22.2
C305	4030016930	S.CER ECJ0EB1A104K	T	39.1/22.2
C306	4030016930	S.CER ECJ0EB1A104K	T	43.6/24.6
C307	4030016930	S.CER ECJ0EB1A104K	T	31.2/28.3
C308	4030016930	S.CER ECJ0EB1A104K	T	43.6/25.5
C309	4030016930	S.CER ECJ0EB1A104K	T	43/26.7
C310	4030016930	S.CER ECJ0EB1A104K	T	43.9/26.7
C312	4030016930	S.CER ECJ0EB1A104K	T	43.4/30.6
C314	4030017780	S.CER ECJ0EB1E472K	T	36.2/33.8
C317	4030011600	S.CER C1608 JB 1E 104K-T	B	42.6/26.2
C318	4030006880	S.CER C1608 JB 1H 472K-T	B	38.6/25.4
C319	4030011600	S.CER C1608 JB 1E 104K-T	B	36.6/26.3
C320	4030018960	S.CER C3216 JB 1C 106MT-N	B	37.3/32.3
C321	4030017660	S.CER ECJ0EB1H330J	T	51.2/30.2
C323	4030017510	S.CER ECJ0EB1H680J	T	47.2/33.3
C325	4030017660	S.CER ECJ0EB1H330J	T	48.8/35.7
C326	4030017640	S.CER ECJ0EB1H150J	T	51/33
C327	4030006880	S.CER C1608 JB 1H 472K-T	B	36.4/30.3
C331	4030017390	S.CER ECJ0EB1H180J	T	46.6/44.5
C333	4030017670	S.CER ECJ0EB1H390J	T	48.4/44.5
C335	4030017390	S.CER ECJ0EB1H180J	T	50.2/44.5
C341	4030007090	S.CER C1608 CH 1H 470J-T	B	42.5/39.7
C342	4030007090	S.CER C1608 CH 1H 470J-T	B	43.7/42.1
C343	4030007140	S.CER C1608 CH 1H 121J-T	B	41.3/39
C344	4030007100	S.CER C1608 CH 1H 560J-T	B	42.7/34.3
C345	4030017510	S.CER ECJ0EB1H680J	T	45.5/37.9
C346	4030017510	S.CER ECJ0EB1H680J	T	45.7/37.9
C401	4030017460	S.CER ECJ0EB1E102K	T	51.1/44.5
C402	4030017460	S.CER ECJ0EB1E102K	T	52.3/48.9
C403	4030017430	S.CER ECJ0EB1H101J	T	47.9/46.1
C411	4030017400	S.CER ECJ0EB1H220J	T	48.1/49.7
C412	4030017630	S.CER ECJ0EB1H120J	T	47.7/47.3
C413	4030017400	S.CER ECJ0EB1H220J	T	46.7/49.4
C451	4030017420	S.CER ECJ0EB1H470J	T	40.2/40.6
C453	4030017460	S.CER ECJ0EB1E102K	T	46.1/46.8
C454	4030017460	S.CER ECJ0EB1E102K	T	35.3/47.9
C456	4030016930	S.CER ECJ0EB1A104K	T	31.2/48
C457	4030017460	S.CER ECJ0EB1E102K	T	35.3/47
C458	4030017460	S.CER ECJ0EB1E102K	T	30.5/49.8
C459	4030017460	S.CER ECJ0EB1E102K	T	27/50.6
C460	4030017780	S.CER ECJ0EB1E472K	T	39/50
C461	4030006880	S.CER C1608 JB 1H 472K-T	T	30.7/42.2
C463	4030017420	S.CER ECJ0EB1H470J	T	40.6/41.8
C464	4030017690	S.CER ECJ0EB1H121J	T	41.5/40.2
C465	4030017400	S.CER ECJ0EB1H220J	T	37.7/41.8
C466	4030017570	S.CER ECJ0EB1H040B	T	38.1/40.6
C467	4030017400	S.CER ECJ0EB1H220J	T	37.2/40.6
C468	4030017360	S.CER ECJ0EB1H030B	T	29/48
C469	4030017370	S.CER ECJ0EB1H3R5B	T	29/47.1
C470	4030017380	S.CER ECJ0EB1H050B	T	29/46.2
C471	4030017380	S.CER ECJ0EB1H050B	T	35.6/43.9
C472	4030017660	S.CER ECJ0EB1H330J	T	34.7/41.8
C473	4030017570	S.CER ECJ0EB1H040B	T	34/43
C474	4030017460	S.CER ECJ0EB1E102K	T	41.6/36.7
C475	4030017460	S.CER ECJ0EB1E102K	T	30.5/36.7

M.=Mounted side (T: Mounted on the Top side, B: Mounted on the Bottom side)
S.=Surface mount

[DDS UNIT]

REF NO.	ORDER NO.	DESCRIPTION	M.	H/V LOCATION
C476	4030017780	S.CER ECJ0EB1E472K	T	29.6/40
C477	4030017780	S.CER ECJ0EB1E472K	T	42.4/48.8
C478	4030006880	S.CER C1608 JB 1H 472K-T	B	39.8/39.1
C479	4030006880	S.CER C1608 JB 1H 472K-T	B	38/37.3
C480	4030017630	S.CER ECJ0EC1H120J	T	35.6/41.8
C481	4030017360	S.CER ECJ0EC1H030B	T	35.6/43
C501	4030007080	S.CER C1608 CH 1H 390J-T	B	19/42.6
C502	4030007120	S.CER C1608 CH 1H 820J-T	B	18.3/44.1
C503	4030007060	S.CER C1608 CH 1H 270J-T	B	16.1/43.8
C504	4030017780	S.CER ECJ0EB1E472K	T	16.1/49.3
C505	4030017660	S.CER ECJ0EC1H330J	T	12.6/47.2
C506	4030017620	S.CER ECJ0EC1H100C	T	12.1/48.4
C507	4030017500	S.CER ECJ0EC1H560J	T	11.4/47.2
C508	4030017580	S.CER ECJ0EC1H060C	T	10.5/48.4
C509	4030017420	S.CER ECJ0EC1H470J	T	10.2/47.2
C510	4030017350	S.CER ECJ0EC1H020B	T	8.9/47.5
C511	4030017670	S.CER ECJ0EC1H390J	T	7.7/47.2
C512	4030017780	S.CER ECJ0EB1E472K	T	5.5/50.7
C513	4030017780	S.CER ECJ0EB1E472K	T	15.9/46.8
C551	4030017650	S.CER ECJ0EC1H270J	T	22.5/45.4
C552	4030017500	S.CER ECJ0EC1H560J	T	21.1/45
C553	4030017650	S.CER ECJ0EC1H270J	T	19.2/45.4
C554	4030017780	S.CER ECJ0EB1E472K	T	15.6/43.2
C555	4030017670	S.CER ECJ0EC1H390J	T	14.5/42
C556	4030017350	S.CER ECJ0EC1H020B	T	14/43.2
C557	4030017420	S.CER ECJ0EC1H470J	T	13.1/42
C558	4030017590	S.CER ECJ0EC1H070C	T	10/43.2
C559	4030017420	S.CER ECJ0EC1H470J	T	8.9/42
C560	4030017630	S.CER ECJ0EC1H120J	T	8.4/43.2
C561	4030017660	S.CER ECJ0EC1H330J	T	7.9/42
C562	4030017780	S.CER ECJ0EB1E472K	T	4.9/45.3
C563	4030017780	S.CER ECJ0EB1E472K	T	11.7/41.6
C601	4030017780	S.CER ECJ0EB1E472K	T	24.7/39.9
C602	4030017400	S.CER ECJ0EC1H220J	T	23.3/37.6
C603	4030017360	S.CER ECJ0EC1H030B	T	21.9/37.8
C604	4030017630	S.CER ECJ0EC1H120J	T	13.3/40.4
C605	4030017620	S.CER ECJ0EC1H100C	T	11.6/40.4
C606	4030017660	S.CER ECJ0EC1H330J	T	18.4/36.9
C607	4030017600	S.CER ECJ0EC1H080C	T	17.7/38.1
C608	4030017650	S.CER ECJ0EC1H270J	T	17.2/36.9
C609	4030017640	S.CER ECJ0EC1H150J	T	16.1/38.1
C610	4030017640	S.CER ECJ0EC1H150J	T	15.9/36.9
C611	4030017440	S.CER ECJ0EC1H221J	T	12.1/39.5
C612	4030017510	S.CER ECJ0EC1H680J	T	10.2/40
C613	4030017620	S.CER ECJ0EC1H100C	T	8.2/40.1
C614	4030017640	S.CER ECJ0EC1H150J	T	5.4/40.3
C615	4030017670	S.CER ECJ0EC1H390J	T	6.8/39.9
C616	4030017780	S.CER ECJ0EB1E472K	T	6.8/38.2
C617	4030017780	S.CER ECJ0EB1E472K	T	22/36.4
C618	4030017650	S.CER ECJ0EC1H270J	T	3.3/37.1
C651	4030017620	S.CER ECJ0EC1H100C	T	24.6/34.8
C652	4030017450	S.CER ECJ0EB1E271K	T	23.7/34.8
C653	4030017590	S.CER ECJ0EC1H070C	T	21.7/35.2
C654	4030017680	S.CER ECJ0EC1H820J	T	20.4/34.8
C655	4030017600	S.CER ECJ0EC1H080C	T	19.2/35.2
C656	4030017420	S.CER ECJ0EC1H470J	T	17.9/34.8
C657	4030017630	S.CER ECJ0EC1H120J	T	16.5/35.2
C658	4030017340	S.CER ECJ0EC1H010B	T	13.3/32.8
C659	4030017360	S.CER ECJ0EC1H030B	T	9.4/32.6
C660	4030017640	S.CER ECJ0EC1H150J	T	14.6/32.3
C661	4030017650	S.CER ECJ0EC1H270J	T	12.8/31.6
C662	4030017400	S.CER ECJ0EC1H220J	T	8.5/31.6
C663	4030017380	S.CER ECJ0EC1H050B	T	8/32.8
C664	4030017460	S.CER ECJ0EB1E102K	T	5.4/34.9
C665	4030017390	S.CER ECJ0EC1H180J	T	7.6/31.6
C666	4030017780	S.CER ECJ0EB1E472K	T	11.5/31.2
C701	4030017460	S.CER ECJ0EB1E102K	T	25/29.3
C702	4030017640	S.CER ECJ0EC1H150J	T	23.6/27.2
C703	4030017540	S.CER ECJ0EC1HR75B	T	22.2/27.4
C704	4030017650	S.CER ECJ0EC1H270J	T	18.7/26.4
C705	4030017350	S.CER ECJ0EC1H020B	T	18.2/27.7
C706	4030017400	S.CER ECJ0EC1H220J	T	17.5/26.4
C707	4030017570	S.CER ECJ0EC1H040B	T	16.6/27.7
C708	4030017390	S.CER ECJ0EC1H180J	T	16.3/26.4
C709	4030017590	S.CER ECJ0EC1H070C	T	13.9/30
C710	4030017500	S.CER ECJ0EC1H560J	T	12.5/29.1
C711	4030017380	S.CER ECJ0EC1H050B	T	11.9/30
C712	4030017500	S.CER ECJ0EC1H560J	T	10.7/29.3
C713	4030017380	S.CER ECJ0EC1H050B	T	9.5/29.6
C714	4030017710	S.CER ECJ0EC1H181J	T	8.1/29.7
C715	4030017630	S.CER ECJ0EC1H120J	T	6.9/29.3
C716	4030017780	S.CER ECJ0EB1E472K	T	21.5/26
C717	4030017460	S.CER ECJ0EB1E102K	T	5.3/29.3
C751	4030017590	S.CER ECJ0EC1H070C	T	24.8/24.5
C752	4030017710	S.CER ECJ0EC1H181J	T	23.9/24.5
C753	4030017380	S.CER ECJ0EC1H050B	T	21.4/24.8
C754	4030017500	S.CER ECJ0EC1H560J	T	20.4/23.9
C755	4030017380	S.CER ECJ0EC1H050B	T	19.8/24.8
C756	4030017650	S.CER ECJ0EC1H270J	T	18.6/24.4
C757	4030017600	S.CER ECJ0EC1H080C	T	16.7/24.8
C758	4030017610	S.CER ECJ0EC1H090C	T	15/21.9

[DDS UNIT]

REF NO.	ORDER NO.	DESCRIPTION	M.	H/V LOCATION
C759	4030017530	S.CER ECJ0EC1H0R5B	T	14.1/22.2
C760	4030017640	S.CER ECJ0EC1H150J	T	13.2/21.9
C761	4030017350	S.CER ECJ0EC1H020B	T	9.7/22.2
C762	4030017630	S.CER ECJ0EC1H120J	T	8.6/21.2
C763	4030017360	S.CER ECJ0EC1H030B	T	8.2/22.4
C764	4030017620	S.CER ECJ0EC1H100C	T	7.7/21.2
C765	4030017460	S.CER ECJ0EB1E102K	T	5.3/24.6
C766	4030017780	S.CER ECJ0EB1E472K	T	11.9/20.8
C802	4030017590	S.CER ECJ0EC1H070C	T	26.5/19.3
C803	4030017380	S.CER ECJ0EC1H050B	T	25.2/18.9
C804	4030017570	S.CER ECJ0EC1H040B	T	24.3/18.9
C806	4030017600	S.CER ECJ0EC1H080C	T	24.3/17.2
C807	4030017360	S.CER ECJ0EC1H030B	T	23.4/18.9
C808	4030017660	S.CER ECJ0EC1H330J	T	23/16.7
C809	4030017570	S.CER ECJ0EC1H040B	T	23/17.6
C810	4030017570	S.CER ECJ0EC1H040B	T	21.7/16.6
C811	4030017590	S.CER ECJ0EC1H070C	T	21.2/17.9
C812	4030017610	S.CER ECJ0EC1H090C	T	20.8/16.6
C813	4030017350	S.CER ECJ0EC1H020B	T	19.7/18.7
C814	4030017580	S.CER ECJ0EC1H060C	T	19.7/17
C815	4030017460	S.CER ECJ0EB1E102K	T	20.3/12.5
C816	4030017460	S.CER ECJ0EB1E102K	T	15.1/10.8
C817	4030017730	S.CER ECJ0EB1E471K	T	19/9
C824	4030017590	S.CER ECJ0EC1H070C	T	13/13
C825	4030017380	S.CER ECJ0EC1H050B	T	14.2/13.4
C826	4030017570	S.CER ECJ0EC1H040B	T	13/15.1
C827	4030017620	S.CER ECJ0EC1H100C	T	14.6/15.5
C828	4030017360	S.CER ECJ0EC1H030B	T	13.9/16.4
C829	4030017660	S.CER ECJ0EC1H330J	T	12.7/16.9
C830	4030017570	S.CER ECJ0EC1H040B	T	11.8/17.6
C831	4030017570	S.CER ECJ0EC1H040B	T	11.8/19.2
C832	4030017590	S.CER ECJ0EC1H070C	T	10.3/19.1
C833	4030017610	S.CER ECJ0EC1H090C	T	8.4/19.1
C834	4030017350	S.CER ECJ0EC1H020B	T	8/17.9
C835	4030017580	S.CER ECJ0EC1H060C	T	7/19.5
C838	4030017460	S.CER ECJ0EB1E102K	T	5.3/19.5
C839	4030017780	S.CER ECJ0EB1E472K	T	25.4/14.5
C840	4030017460	S.CER ECJ0EB1E102K	T	6.5/15.6
C841	4030006860	S.CER C1608 JB 1H 102K-T	B	3.6/22.2
C851	4030017780	S.CER ECJ0EB1E472K	T	4.5/14
C901	4030017780	S.CER ECJ0EB1E472K	T	2.4/68.4
C902	4030017430	S.CER ECJ0EC1H101J	T	16/53.2
C951	4030016930	S.CER ECJ0EB1A104K	T	52.3/38.2
C952	4030011600	S.CER C1608 JB 1E 104K-T	T	58.3/46.9
C953	4030016930	S.CER ECJ0EB1A104K	T	54/18.3
C954	4030017780	S.CER ECJ0EB1E472K	T	54.1/28.1
C955	4030016930	S.CER ECJ0EB1A104K	T	52.8/33.2
C956	4030016930	S.CER ECJ0EB1A104K	T	49.2/21
C957	4030016930	S.CER ECJ0EB1A104K	T	53.8/35.9
C958	4030017780	S.CER ECJ0EB1E472K	T	52.8/34.1
C959	4030017780	S.CER ECJ0EB1E472K	T	52.8/35
C960	4030016930	S.CER ECJ0EB1A104K	T	53.5/38.9
C961	4030016930	S.CER ECJ0EB1A104K	T	52.3/39.8
C962	4030016930	S.CER ECJ0EB1A104K	T	52.3/44.6
C963	4030016930	S.CER ECJ0EB1A104K	T	53.5/38
C964	4030017460	S.CER ECJ0EB1E102K	T	55/44.8
C966	4030016930	S.CER ECJ0EB1A104K	T	52.3/41.4
C967	4030016930	S.CER ECJ0EB1A104K	T	52.3/43
C968	4030018960	S.CER C3216 JB 1C 106MT-N	B	42/43.9
C972	4030018970	S.CER C3225 JB 1C 226MT-N	B	42.2/3.5
C973	4030018970	S.CER C3225 JB 1C 226MT-N	B	29/2.7
C974	4030018970	S.CER C3225 JB 1C 226MT-N	B	32/2.7
C975	4550007140	S.TAN TEESVD 1C 107M12R	B	16.7/4.1
C976	4550007140	S.TAN TEESVD 1C 107M12R	B	23.5/10.5
C977	4550007140	S.TAN TEESVD 1C 107M12R	B	23.5/19.5
C978	4550007140	S.TAN TEESVD 1C 107M12R	B	32.3/10.5
C981	4030016930	S.CER ECJ0EB1A104K	T	54.4/12.5
C982	4030006860	S.CER C1608 JB 1H 102K-T	B	14/67.1
C983	4030006860	S.CER C1608 JB 1H 102K-T	B	7.4/74
C991	4030006860	S.CER C1608 JB 1H 102K-T	B	10/68.1
C992	4030006860	S.CER C1608 JB 1H 102K-T	B	7.2/67.3
C993	4030006860	S.CER C1608 JB 1H 102K-T	B	4.2/74
C994	4030006860	S.CER C1608 JB 1H 102K-T	B	5.6/71.3
C995	4030006860	S.CER C1608 JB 1H 102K-T	B	2.2/59.2
C996	4030006860	S.CER C1608 JB 1H 102K-T	B	5/58.8
C997	4030006860	S.CER C1608 JB 1H 102K-T	B	2.9/55
C998	4030006860	S.CER C1608 JB 1H 102K-T	B	3.1/62.6
C1001	4030011600	S.CER C1608 JB 1E 104K-T	T	58.3/48.4
C1051	4030006880	S.CER C1608 JB 1H 472K-T	B	20.2/65.3
C1052	4030006880	S.CER C1608 JB 1H 472K-T	B	19.2/60.3
C1101	4030017780	S.CER ECJ0EB1E472K	T	38.9/52.1
C1102	4030017780	S.CER ECJ0EB1E472K	T	44.2/50.3
C1104	4030017780	S.CER ECJ0EB1E472K	T	42.2/62.2
C1105	4030017780	S.CER ECJ0EB1E472K	T	40.6/59.9
C1106	4030017780	S.CER ECJ0EB1E472K	T	40.4/55.9
C1107	4030017780	S.CER ECJ0EB1E472K	T	43.3/56.9
C1108	4030017460	S.CER ECJ0EB1E102K	T	40.1/62.2
C1109	4030006880	S.CER C1608 JB 1H 472K-T	B	35.1/76.9
C1110	4030017780	S.CER ECJ0EB1E472K	T	33.5/59.6
C1111	4030017780	S.CER ECJ0EB1E472K	T	29.7/59.6
C1112	4030017780	S.CER ECJ0EB1E472K	T	38.2/63.4

M.=Mounted side (T: Mounted on the Top side, B: Mounted on the Bottom side)
S.=Surface mount

[DDS UNIT]

REF NO.	ORDER NO.	DESCRIPTION	M.	H/V LOCATION
C1113	4030017780	S.CER ECJ0EB1E472K	T	37.1/59.7
C1114	4030017780	S.CER ECJ0EB1E472K	T	24.4/60.6
C1115	4030017780	S.CER ECJ0EB1E472K	T	35.3/59.8
C1116	4030017460	S.CER ECJ0EB1E102K	T	23.1/63.7
C1117	4030006860	S.CER C1608 JB 1H 102K-T	B	20.9/63.9
C1151	4030017780	S.CER ECJ0EB1E472K	T	50.5/66.3
C1152	4030017780	S.CER ECJ0EB1E472K	T	46.4/66.3
C1153	4030017780	S.CER ECJ0EB1E472K	T	43.7/68.2
C1154	4030017780	S.CER ECJ0EB1E472K	T	52/66.3
C1155	4030017780	S.CER ECJ0EB1E472K	T	57.9/68.3
RL1101	6330001721	RLY ATN207-K1		
J151	6510007020	CNR TMP-J01X-V6		
J851	6510018450	CNR TMP-S01X-B1		
J951	6510024880	S.CNR 52689-3087	T	59.2/35.3
J952	6510024880	S.CNR 52689-3087	T	59.2/12.4
J1001	6510003520	CNR S04B-EH-S		
J1051	6450001790	CNR HLJ7000-01-3010		
J1101	6450001641	CNR TCS5044-0141177		
J1151	6450001841	CNR TCS7568-43-201		
EP6	6910012350	S.BEA MMZ1608Y 102BT	B	12.9/8.4
EP251	6910012350	S.BEA MMZ1608Y 102BT	B	33.1/18.7
EP301	6910012350	S.BEA MMZ1608Y 102BT	B	49.7/25
EP302	6910012350	S.BEA MMZ1608Y 102BT	B	32.9/27.8
EP303	6910012350	S.BEA MMZ1608Y 102BT	B	32.9/26.1
EP304	6910012350	S.BEA MMZ1608Y 102BT	B	35.8/28.4
EP305	6910012350	S.BEA MMZ1608Y 102BT	B	41/27.1
EP451	6910012350	S.BEA MMZ1608Y 102BT	B	39.9/47.8
EP452	6910012350	S.BEA MMZ1608Y 102BT	B	48.6/44.6
EP809	6910012350	S.BEA MMZ1608Y 102BT	B	16.6/7.1
EP951	6910012350	S.BEA MMZ1608Y 102BT	B	53.3/24.3
EP952	6910012350	S.BEA MMZ1608Y 102BT	B	49.9/22.6
EP953	6910012350	S.BEA MMZ1608Y 102BT	T	54/43.4
EP954	6910012350	S.BEA MMZ1608Y 102BT	T	54/42.1
EP955	6910012350	S.BEA MMZ1608Y 102BT	T	54.2/40
EP956	6910012350	S.BEA MMZ1608Y 102BT	T	54.6/37
EP957	6910012350	S.BEA MMZ1608Y 102BT	B	39.5/46.1
EP958	6910012350	S.BEA MMZ1608Y 102BT	B	55.9/47.4
EP959	6910012350	S.BEA MMZ1608Y 102BT	B	55.9/32.7
EP960	6910012350	S.BEA MMZ1608Y 102BT	B	56.9/28.9
EP964	6910012350	S.BEA MMZ1608Y 102BT	B	53.3/22.2
EP981	6910012350	S.BEA MMZ1608Y 102BT	T	55.3/14.2
EP1003	6910016790	S.BEA FHH-1M3216-601	T	57.3/50.3
EP1004	6910016790	S.BEA FHH-1M3216-601	T	53.9/50
EP1051	6910012350	S.BEA MMZ1608Y 102BT	B	20.2/66.8
EP1052	6910012350	S.BEA MMZ1608Y 102BT	B	19.2/58.7
EP1100	6910012350	S.BEA MMZ1608Y 102BT	B	38.7/63.4
EP1101	6910012350	S.BEA MMZ1608Y 102BT	T	27.5/63.3
EP1102	6910012350	S.BEA MMZ1608Y 102BT	T	34.4/62.4
EP1103	6910012350	S.BEA MMZ1608Y 102BT	T	51.1/69.2
EP1104	6910012350	S.BEA MMZ1608Y 102BT	T	56.1/69.2
EP1105	6910014730	S.BEA MPZ2012S331A-T	B	41/67.8
EP1106	6910014730	S.BEA MPZ2012S331A-T	B	34.7/61.7
EP1107	6910014730	S.BEA MPZ2012S331A-T	B	31.4/61.7
EP1108	6910014730	S.BEA MPZ2012S331A-T	B	27.5/73.6

[CONNECT UNIT]

REF NO.	ORDER NO.	DESCRIPTION	M.	H/V LOCATION
J1	6510019971	S.CNR 52808-1071		
W1	8900014810	CBL OPC-1579		

[CHASSIS UNIT]

REF NO.	ORDER NO.	DESCRIPTION	M.	H/V LOCATION
J1	6510000370	CNR MR-DS		
J2	6510000370	CNR MR-DS		
SP1	2510000991	SP VS-C66Y0811A		
MF1	2710000790	FAN AFB0512HB-4L50		
W1	8600037110	WIR SP CABLE (P01CH)		
W3	8900015210	CBL OPC-1448A (P0.5, N28, L60)		
W4	8900015210	CBL OPC-1448A (P0.5, N28, L60)		
W5	8900015220	CBL OPC-1461A (P0.5, N30, L40)		
W6	8900015220	CBL OPC-1461A (P0.5, N30, L40)		
W7	8900013970	CBL OPC-1450 (N=10, L=53)		
W11	8600037122	WIR P02*J03CH-2 M500		
W15	8970024620	WIR 1.5D COAXIAL 95 mm		
W17	8970024630	WIR 1.5D COAXIAL 170 mm		

M.=Mounted side (T: Mounted on the Top side, B: Mounted on the Bottom side)
S.=Surface mount

[HM-151]

REF NO.	ORDER NO.	DESCRIPTION	M.	H/V LOCATION
IC1	1140011490	S.IC μPD789071MC-041-5A4-E1	B	51.1/24.5
IC3	1110006310	S.IC BD5245G-TR	B	67.3/34.8
Q1	1530001941	S.TR 2SC2712-BL (TE85R,F)	B	26.1/11
Q2	1590000680	S.TR DTC114EUA T106	B	21.6/34.8
Q3	1590001330	S.TR DTA114EUA T106	B	24.7/34.8
Q5	1510000771	S.TR 2SA1586-GR (TE85R,F)	B	54.8/37.7
D1	1790000950	S.ZEN MA8056-M (TX)	B	23.1/17
D3	1750000940	S.DIO ISS400 TE61	B	64.7/23.2
D4	1750000940	S.DIO ISS400 TE61	B	64.7/29.2
D6	1750000940	S.DIO ISS400 TE61	B	58.7/20.8
D7	1750000940	S.DIO ISS400 TE61	B	42.8/16.7
D9	1750000940	S.DIO ISS400 TE61	B	34.1/16.3
D10	1750000940	S.DIO ISS400 TE61	B	34.9/17.8
D11	1750000940	S.DIO ISS400 TE61	B	38.8/14.5
D16	1730002280	S.ZEN MA8091-M (TX)	B	55.2/14.5
D17	1730002280	S.ZEN MA8091-M (TX)	B	48.8/14.5
D18	1730002280	S.ZEN MA8091-M (TX)	B	13.1/13.7
X1	6060000610	S.CER EFOS4914E3	B	42.6/22.3
L1	6200005051	S.COL NLV25T-330J	B	12.3/28.9
L2	6200005011	S.COL NLV25T-100J	B	11/13.9
R2	7030000400	S.RES MCR10EZHZ 1.5 kΩ	B	24.2/8.3
R3	7030000400	S.RES MCR10EZHZ 1.5 kΩ	B	41.9/8.3
R4	7030000400	S.RES MCR10EZHZ 1.5 kΩ	B	57.3/8.2
R5	7030003400	S.RES ERJ3GEYJ 471 V (470Ω)	B	28.6/11.2
R6	7030003620	S.RES ERJ3GEYJ 333 V (33 kΩ)	B	26.8/34.7
R7	7030003620	S.RES ERJ3GEYJ 333 V (33 kΩ)	B	23.3/36.8
R8	7030003550	S.RES ERJ3GEYJ 822 V (8.2 kΩ)	B	19.1/33.7
R11	7030003480	S.RES ERJ3GEYJ 222 V (2.2 kΩ)	B	53/35
R12	7030003560	S.RES ERJ3GEYJ 103 V (10 kΩ)	B	55/34.2
R14	7030003440	S.RES ERJ3GEYJ 102 V (1 kΩ)	B	47.2/6.1
R18	7030003560	S.RES ERJ3GEYJ 103 V (10 kΩ)	B	41.6/33.6
R19	7030003640	S.RES ERJ3GEYJ 473 V (47 kΩ)	B	38.4/34.5
R22	7030003520	S.RES ERJ3GEYJ 472 V (4.7 kΩ)	B	37.9/18.7
R23	7030003520	S.RES ERJ3GEYJ 472 V (4.7 kΩ)	B	56.1/18.1
R24	7030003520	S.RES ERJ3GEYJ 472 V (4.7 kΩ)	B	58/18.6
R25	7030003520	S.RES ERJ3GEYJ 472 V (4.7 kΩ)	B	59.8/18.9
R27	7030003560	S.RES ERJ3GEYJ 103 V (10 kΩ)	B	68.1/32.5
R35	7030000400	S.RES MCR10EZHZ 1.5 kΩ	B	69.1/11.9
R36	7030003560	S.RES ERJ3GEYJ 103 V (10 kΩ)	B	20.5/30.6
R37	7030003460	S.RES ERJ3GEYJ 152 V (1.5 kΩ)	B	19.1/30.6
R39	7030003480	S.RES ERJ3GEYJ 222 V (2.2 kΩ)	B	24.4/5.7
R40	7030003480	S.RES ERJ3GEYJ 222 V (2.2 kΩ)	B	24.4/3
R41	7030003580	S.RES ERJ3GEYJ 153 V (15 kΩ)	B	17/32.7
R42	7030003860	S.RES ERJ3GE JPW V	B	68.4/21.6
R44	7030003440	S.RES ERJ3GEYJ 102 V (1 kΩ)	B	57.3/22.1
R45	7030003440	S.RES ERJ3GEYJ 102 V (1 kΩ)	B	53.9/18
R46	7030003440	S.RES ERJ3GEYJ 102 V (1 kΩ)	B	37.8/15.8
R47	7030003440	S.RES ERJ3GEYJ 102 V (1 kΩ)	B	37.6/17.1
R48	7030003440	S.RES ERJ3GEYJ 102 V (1 kΩ)	B	45.3/17.6
R49	7030003440	S.RES ERJ3GEYJ 102 V (1 kΩ)	B	57.3/26.2
R50	7030003440	S.RES ERJ3GEYJ 102 V (1 kΩ)	B	58.1/23.4
C1	4030006850	S.CER C1608 JB 1H 471K-T	B	52/16.9
C2	4510008500	S.ELE EEE1CA101WP	B	35.5/5.8
C5	4030007050	S.CER C1608 CH 1H 220J-T	B	14.9/30.4
C9	4030007050	S.CER C1608 CH 1H 220J-T	B	20.8/16.8
C10	4030007050	S.CER C1608 CH 1H 220J-T	B	19.8/11.6
C11	4030007050	S.CER C1608 CH 1H 220J-T	B	17/5.6
C12	4030011600	S.CER C1608 JB 1E 104K-T	B	64.9/34.4
C13	4030011600	S.CER C1608 JB 1E 104K-T	B	44.3/27.6
C14	4030006900	S.CER C1608 JB 1H 103K-T	B	67.5/37.2
C16	4030006860	S.CER C1608 JB 1H 102K-T	B	14.7/13.6
C17	4030006880	S.CER C1608 JB 1H 472K-T	B	11.7/17.4
C18	4030006880	S.CER C1608 JB 1H 472K-T	B	10.4/17.4
C19	4030011600	S.CER C1608 JB 1E 104K-T	B	13/25.8
C21	4030011600	S.CER C1608 JB 1E 104K-T	B	11.7/25.8
C22	4030011600	S.CER C1608 JB 1E 104K-T	B	10.4/28.5
C23	4030011600	S.CER C1608 JB 1E 104K-T	B	23.1/14
C24	4030011600	S.CER C1608 JB 1E 104K-T	B	67.2/12.1
C25	4030011600	S.CER C1608 JB 1E 104K-T	B	25.6/32.2
C26	4030011600	S.CER C1608 JB 1E 104K-T	B	44.5/6.1
C27	4030011600	S.CER C1608 JB 1E 104K-T	B	51.7/35
C29	4510008540	S.ELE EEE1CA100SR	B	26.4/16
C30	4030010210	S.CER C3216 JB 1C 105M-T	B	19.8/4.6
C31	4510008540	S.ELE EEE1CA100SR	B	28.3/4.9
C32	4030011600	S.CER C1608 JB 1E 104K-T	B	55/35.7
J1	6510023110	CNR 3008L-8P8C		

[HM-151]

REF NO.	ORDER NO.	DESCRIPTION	M.	H/V LOCATION
DS1	5010000120	S.LED LN1371G-(TR)	T	21.9/11
DS2	5010000120	S.LED LN1371G-(TR)	T	21.9/32
DS3	5010000120	S.LED LN1371G-(TR)	T	39.3/11
DS4	5010000120	S.LED LN1371G-(TR)	T	39.3/32
DS5	5010000120	S.LED LN1371G-(TR)	T	55.9/2.5
DS6	5010000120	S.LED LN1371G-(TR)	T	56.2/26.8
DS7	5010000120	S.LED LN1371G-(TR)	T	71.7/14.8
DS8	5010000120	S.LED LN1371G-(TR)	T	72.2/33.8
DS10	5040002890	S.LED SML-310FT T86	T	51.6/5
DS11	5040002620	S.LED SML-311UT T86	T	51.6/38
MC1	7700002310	MIC EM-140		
S1	2260000980	SW SKHHLPO14A		
W1	8900011270	WIR OPC-1153		
EP1	6910012350	S.BEA MMZ1608Y 102BT	B	10.4/25.8
EP2	6910012350	S.BEA MMZ1608Y 102BT	B	14.3/17.4
EP3	6910012350	S.BEA MMZ1608Y 102BT	B	13/17.4
EP4	6910012350	S.BEA MMZ1608Y 102BT	B	14.7/11
EP5	6910012350	S.BEA MMZ1608Y 102BT	B	15/25

M.=Mounted side (T: Mounted on the Top side, B: Mounted on the Bottom side)
S.=Surface mount

SECTION 6 MECHANICAL PARTS AND DISASSEMBLY

[FRONT UNIT]

REF. NO.	ORDER NO.	DESCRIPTION	QTY.
W1	8900013940	Cable OPC-1447 (N=10, L=30)	1
W2	8900013990	Cable OPC-1445	1
DS1	5030002820	LCD LTA025A161A	1
EP1	0880001670	Encoder EX-2832	1
MP1	8210021760	2427 front panel	1
MP2	8210021770	2427 rear panel	1
MP4	8310063800	2427 window plate	1
MP5	8930069540	2427 A-window sheet	1
MP11	8610012370	Knob N328	1
MP12	8610012380	Knob N328 (A)	1
MP13	8610012390	Knob N329	1
MP14	8610012400	Knob N330	1
MP18	8930065660	2427 brake button	1
MP19	8930065541	2427 power button-1	1
MP20	8930065550	2427 release button	1
MP21	8610012340	Knob K246	1
MP22	8610012330	Knob K247	1
MP23	8610012320	Knob K248	1
MP24	8610012311	Knob K249-1	1
MP25	8610012300	Knob K250	1
MP26	8610012290	Knob K251	1
MP27	8610012280	Knob K252	1
MP28	8610012270	Knob K253	1
MP29	8610012260	Knob K254	1
MP30	8610012250	Knob K255	1
MP31	8610012240	Knob K255 (A)	1
MP32	8610012210	Knob K256	1
MP33	8610012220	Knob K257	1
MP34	8610012230	Knob K258	1
MP35	8930065530	2427 TS lock button	1
MP41	8930065590	2427 LCD holder	1
MP42	8210021790	2427 reflector	1
MP43	8850002610	Plain washer (AI)	1
MP44	8830002440	2427 nut	1
MP51	8930065570	2427 A-release button	1
MP52	8930065580	2427 B-release button	1
MP61	8950006480	2427 B-contact base	1
MP64	8930065610	2427 LCD filter	1
MP65	8930069670	2427 A-LCD sheet	1
MP67	8930065600	Coil spring (AI)	2
MP72	8830001010	Hex nut (A)	2
MP74	8930036740	1691 brake pad	2
MP81	8810009220	Screw PH B0 M2 × 8 ZK (BT)	3
MP82	8810009220	Screw PH B0 M2 × 8 ZK (BT)	2
MP83	8930066680	Coil spring (AJ)	2
MP84	8850000110	Flat washer M2 NI BS	2
MP85	8810008640	Screw FH BT M2 × 4 NI-ZU	2
MP86	8930065560	2427 slide button	1
MP87	8010020110	2427 LCD frame	1
MP88	8930066450	2427 A-prism sheet	1
MP89	8930066440	2427 B-prism sheet	1
MP90	8930062190	Double side tape (AJ)	2
MP91	8610012551	Knob N331 assembly -1 (incl: Base, Cover, Finger reset, etc)	1
MP101	8930066760	2427 A-sponge	2
MP102	8930066750	2427 B-sponge	1
MP103	8930066740	2427 C-sponge	1
MP104	8930066730	2427 D-sponge	1
MP106	8930067580	Insulation sheet (LG)	1
MP107	8930049260	Himelon sheet CA	2
MP108	8930067710	2427 A-sheet	1
MP109	8930067720	2427 B-sheet	1
MP110	8930067700	2427 B.P. sheet	1
MP111	8930067960	Sponge (IQ)	1

[DISPLAY UNIT]

REF. NO.	ORDER NO.	DESCRIPTION	QTY.
MP1	8510016980	2427 shield case	1
MP2	8510016970	2427 shield plate	1

[VR UNIT]

REF. NO.	ORDER NO.	DESCRIPTION	QTY.
R1	7210003230	Variable resistor TP96D00A-17F-10KBX2	1
S1	2250000170	Encoder TP90D96AE20-17F (1352)	1

[MAIN UNIT]

REF. NO.	ORDER NO.	DESCRIPTION	QTY.
MP1	8510017200	2427 A-shield plate	1
MP2	8930067510	2427 B-earth spring	1
MP3	8930030380	Ferrite sheet (C) 15 × 8 × 2	1
MP4	8930068000	Shield sponge (AT)	1
MP101	8510017330	2427 LPF case Y807	1
MP102*	8930068000	Shield sponge (AT)	1
MP201	8510017210	2427 B-shield plate	1
MP501*	8510017620	2427 mix shield plate	1
MP802	8930067500	2427 A-earth spring	1
MP1951	8510017200	2427 A-shield plate	1
MP2001	8510017170	2427 mic plate	1
MP2002	8930068240	2427 C-earth spring	1

[LOGIC UNIT]

REF. NO.	ORDER NO.	DESCRIPTION	QTY.
BT1301	3020000330	Lithium battery ML920S/F9D	1
MP1	8510017000	2427 logic case	1
MP2	8510016990	2427 logic cover	1
MP3	8930068080	Thermally sheet (AU)	1
MP5	8930068370	2427 A-magnetic shield	1
MP6	8930056010	Enboss tape (K)	2
MP7	8930068370	2427 A-magnetic shield	1
MP201	8930055051	Thermally sheet (V)-1	1
MP301	8930062210	Thermally sheet (AL)	1
MP1301	8930052770	Double coated tape (Y)	1
MP2221	8930055051	Thermally sheet (V)-1	1

[DDS UNIT]

REF. NO.	ORDER NO.	DESCRIPTION	QTY.
J1051	6450001790	Connector HLJ7000-01-3010	1
J1101	6450001640	Connector TCS5044-01-4111	1
J1151	6450001840	Connector TCS7568-43-201	1
MP201	8510017200	2427 A-shield plate	1
MP202*	8510017440	2427 B-DDS plate	1
MP301*	8510017230	2427 DDS case	1
MP302	8930024170	Earth spring (G)	1
MP321*	8510017250	2427 DDS plate	1
MP451	8510017500	2427 C-shield plate	1
MP452*	8510017240	2427 A-DDS case	1
MP453*	8930063970	Shield sponge (AM)	1
MP601	8930067520	2427 DDS spring	1
MP801*	8930024170	Earth spring (G)	1
MP851	8510017260	2427 A-DDS plate	1
MP1101	8930067530	Sponge (IP)	1
MP1102	8930067520	2427 DDS spring	1

*: Refer to SEC 8 BOARD LAYOUTS.

[CHASSIS PARTS]

REF. NO.	ORDER NO.	DESCRIPTION	QTY.
J1	6510000370	Connector MR-DS	1
J2	6510000370	Connector MR-DS	1
W1	8600037110	SP cable	1
W3	8900015210	Cable OPC-1448A (N=28, L=60)	1
W4	8900015210	Cable OPC-1448A (N=28, L=60)	1
W5	8900015220	Cable OPC-1461A (N=30, L=40)	1
W6	8900015220	Cable OPC-1461A (N=30, L=40)	1
W7	8900013970	Cable OPC-1450 (N=10, L=53)	1
W11	8600037122	Cable SX2427 P02 × J03CH-2 M500	1
W15	8970024620	Wire 1.5D 95MM C31/C31	1
W17	8970024630	Wire 1.5D170MM C31/C31	1
SP1	2510000991	Speaker VS-C66Y0811A	1
MF1	2710000790	Fan AFB0512HB-4L50	1
EP2	9010001410	Tube	1
MP1	8010019970	2427 chassis	1
MP2	8110008491	2427 U-cover assembly -1 (incl: U-cover, SP net, A net, B net, etc)	1
MP3	8110008341	2427 L-cover-1	1
MP4	8860001370	2427 ANT lug	2
MP5	8930065990	2427 ANT plate	2
MP6	8210021781	2427 chassis panel-1	1
MP11	8930042440	1897 SP holder	1
MP13	8930002910	Rubber foot (B)	2
MP14	8810008660	Screw PH BT M3 × 8 NI-ZU	17
MP15	8810008660	Screw PH BT M3 × 8 NI-ZU	4
MP16	8810010590	Screw PH BT M3 × 20 NI-ZU	4
MP17	8810009560	Screw PH BT M2 × 6 ZK	1
MP18	8810004280	Screw PH M3 × 5 ZK	7
MP19	8810004430	Screw PH M3 × 6 ZK	4
MP20	8810009040	Setscrew H M2.6 × 10 NI	8
MP21	8810008020	Setscrew C M2.6 × 12 ZK	2
MP22	8810009610	Screw FH M2.6 × 6 ZK	16
MP23	8810009610	Screw FH M2.6 × 6 ZK	4
MP24	8810009070	Screw PH M2.6 × 8 ZK	2
MP25	8930048550	2177 clip	1
MP31	8930005790	Foot (A)	1
MP32	8930005800	Foot (B)	1
MP33	8930065980	2427 stand	1
MP35	8930065920	2427 fan holder	1
MP36	8930065930	2427 fan rubber	1
MP37	8810008660	Screw PH BT M3 × 8 NI-ZU	2
MP38	8930065910	2427 earth spring	1
MP40	8930065630	2427 fuse sheet	1
MP41	8930065910	2427 earth spring	1
MP42	8310064590	2427 plate	1
MP43	8820000530	Bolt M4 × 8 NI	1
MP44	8850000140	Flat washer M4 NI BS	1
MP45	8850001560	Washer M4	1
MP46	8930066720	2427 USB sheet	1
MP47	8930067490	2427 fan spring	1
MP48	8930067540	2427 shield tape	4
MP49	8930067740	2427 magnetic shield	1
MP50	8930067980	Shield sponge (AS)	1
MP51	8930068000	Shield sponge (AT)	1
MP52	8930068000	Shield sponge (AT)	1
MP53	8930063970	Shield sponge (AM)	1
MP54	8930063970	Shield sponge (AM)	1
MP55	8930027730	Sponge (DC)	1
MP56	8930063430	CU sheet (S)	1
MP57	8930068260	Thermally sheet (AV)	2
MP58	8930067980	Shield sponge (AS)	1
MP59	8930068390	2427 D-earth spring	1
MP60	8930068420	Sponge (IS)	1
MP61	8930068380	Sponge (IR)	1
MP62	8930032100	Sponge (DP)	2
MP63	8930069070	Shield sponge (AU)	1
MP64	8930043800	Double coated tape (S)	1

[PA UNIT]

REF. NO.	ORDER NO.	DESCRIPTION	QTY.
F1	5220000340	Holder FHA010-03	1
F2	5210000940	Fuse 1205	1
W701	8900013900	Cable OPC-1455	1
MP201*	8930068250	2427 PA plate	1
MP251*	8930014140	Earth spring (D)	1
MP301	8860001130	2177 PA shield plate	1
MP302	8860001130	2177 PA shield plate	1
MP401	8860001360	2427 RUG	1
MP402	8930014140	Earth spring (D)	1
MP403*	8930014140	Earth spring (D)	1
MP404*	8930014140	Earth spring (D)	1
MP405	8930067570	2427 A-PA spring	1
MP410	8930067290	Shield sponge (AR)	1
MP501	8510016950	2427 PA cover	1
MP502*	8930014140	Earth spring (D)	1
MP531	8930068400	2427 E-earth spring	1
MP551*	8510012150	2177 PA S-plate	1
MP871*	8930014140	Earth spring (D)	1
MP901*	8930014140	Earth spring (D)	1

*: Refer to SEC 8 BOARD LAYOUTS.

[DRIVER UNIT]

REF. NO.	ORDER NO.	DESCRIPTION	QTY.
MP1	8410002480	2429 PA heatsink	1

[CONNECT UNIT]

REF. NO.	ORDER NO.	DESCRIPTION	QTY.
W1	8900014810	Cable OPC-1579	1
MP1	8950006470	2427 A-contact base	1

Screw abbreviations BT, B0: Self-tapping
 FH: Flat head PH: Pan head
 ZK: Black BS: Brass
 NI: Nickel NI-ZU: Nickel-Zinc

[ACCESSORIES]

REF. NO.	ORDER NO.	DESCRIPTION	QTY.
P1	5610000050	Plug AP330	1
P2	5610000170	Plug AP370B	1
F1	5210000840	Fuse ATC-30	2
F2	5210000940	Fuse 1205	1
W1	8900013980	Cable OPC-1457 [USA], [EXP] only	1
W2	8900006110	Cable OPC-596	1
EP1	0880001680	Cable OPC-1457R except [USA], [EXP]	1
EP2	6910011940	Bead ZCAT2436 except [USA], [EXP]	1
MC1	Optional product	Microphone HM-151	1
MP1	8930007300	Mic hanger	1

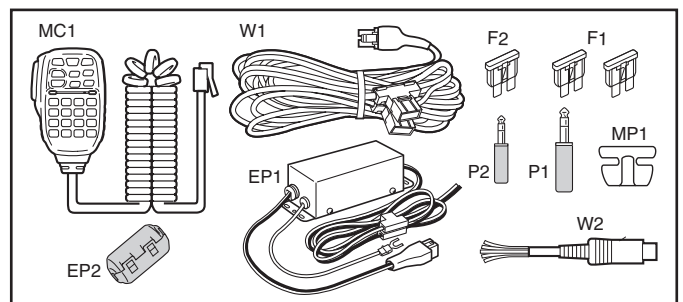

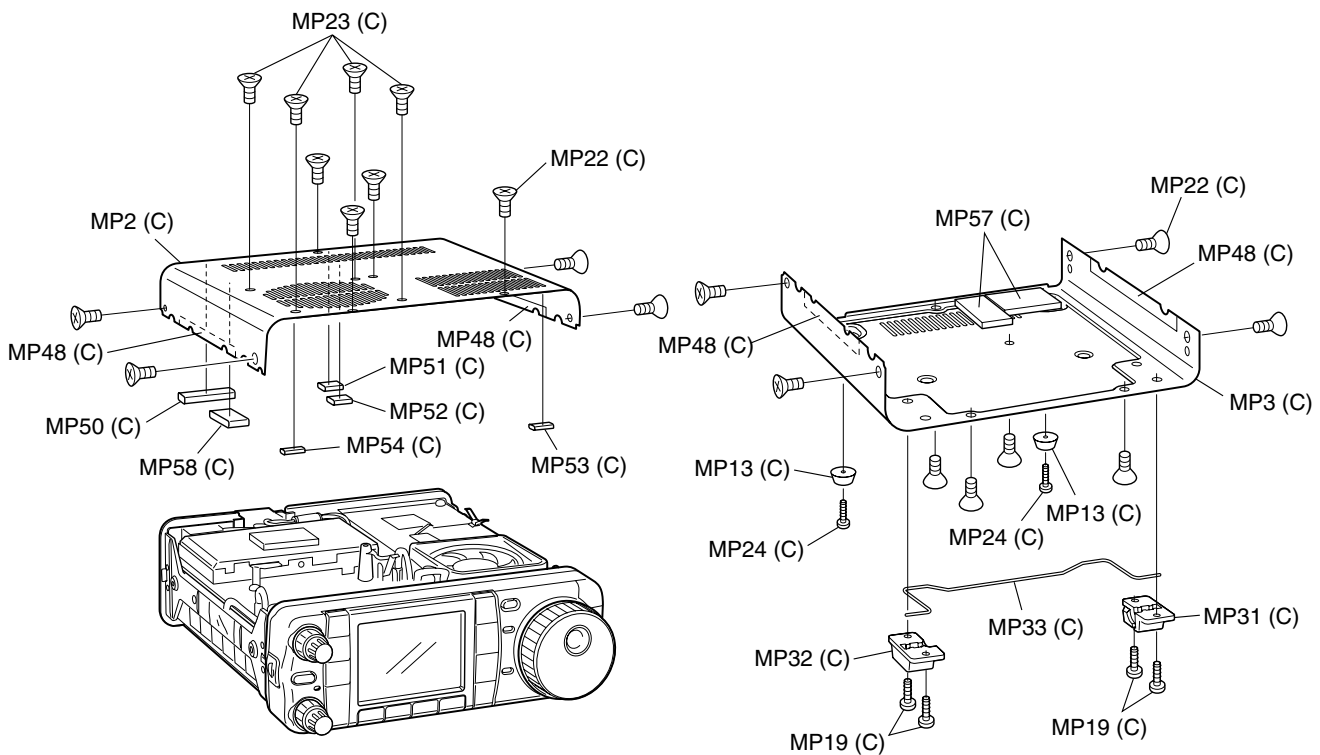
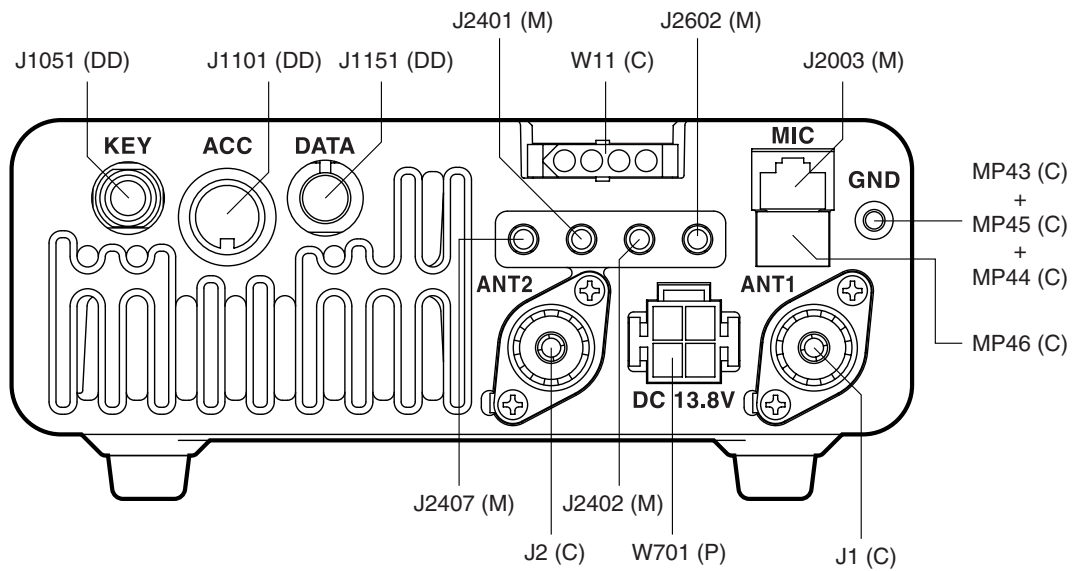
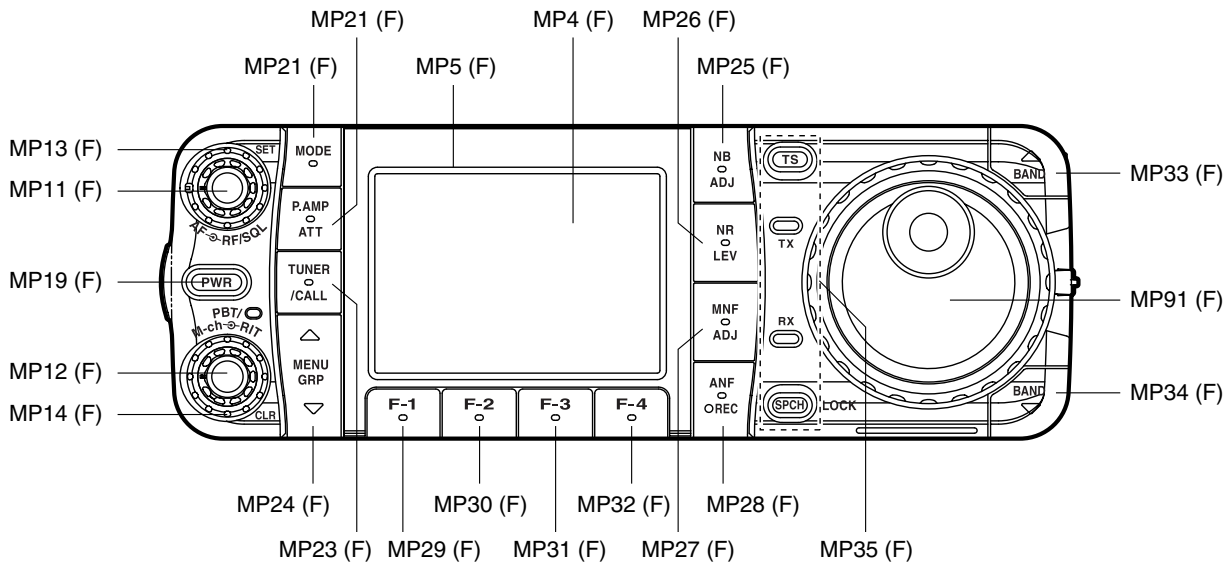

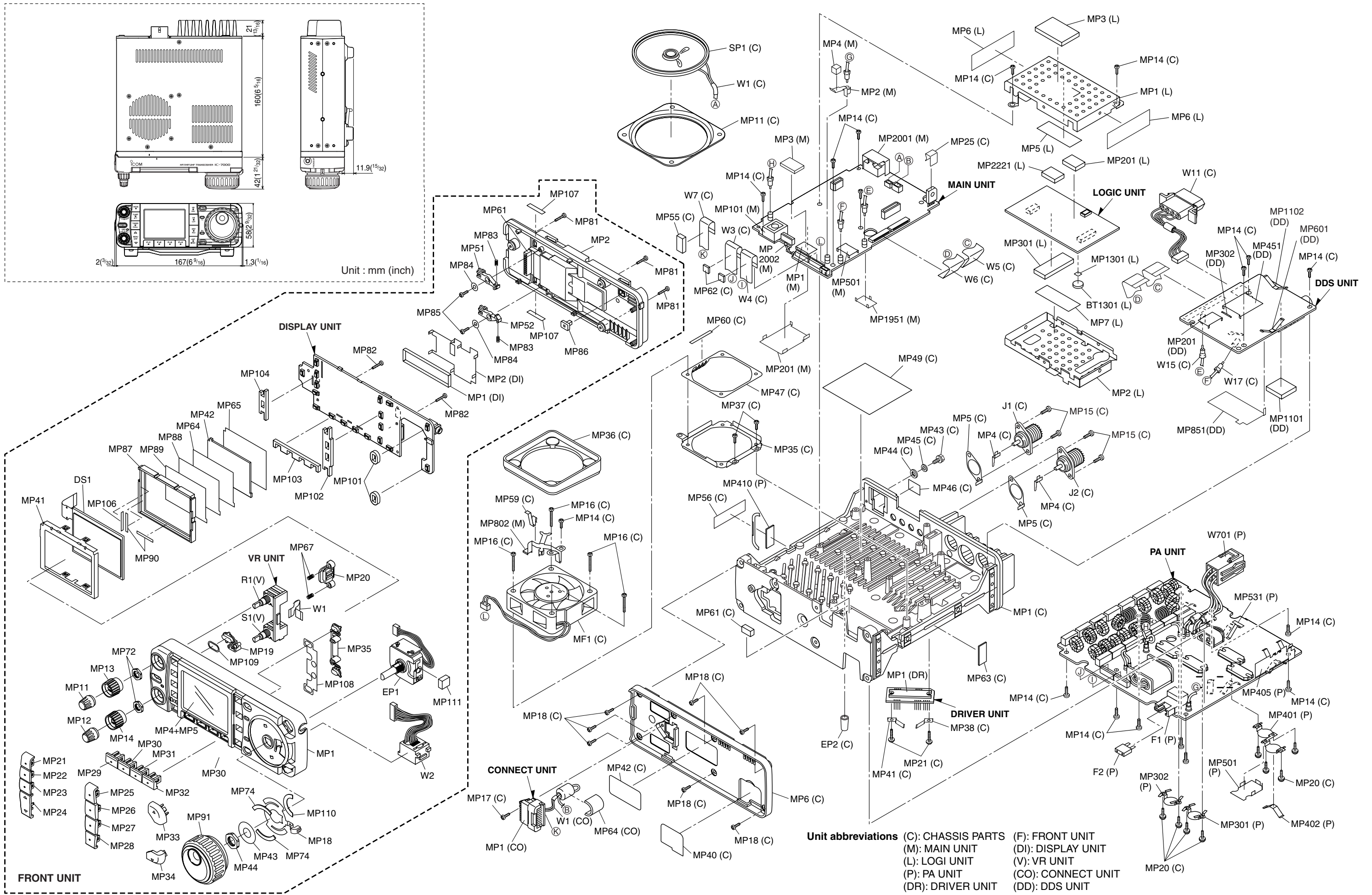
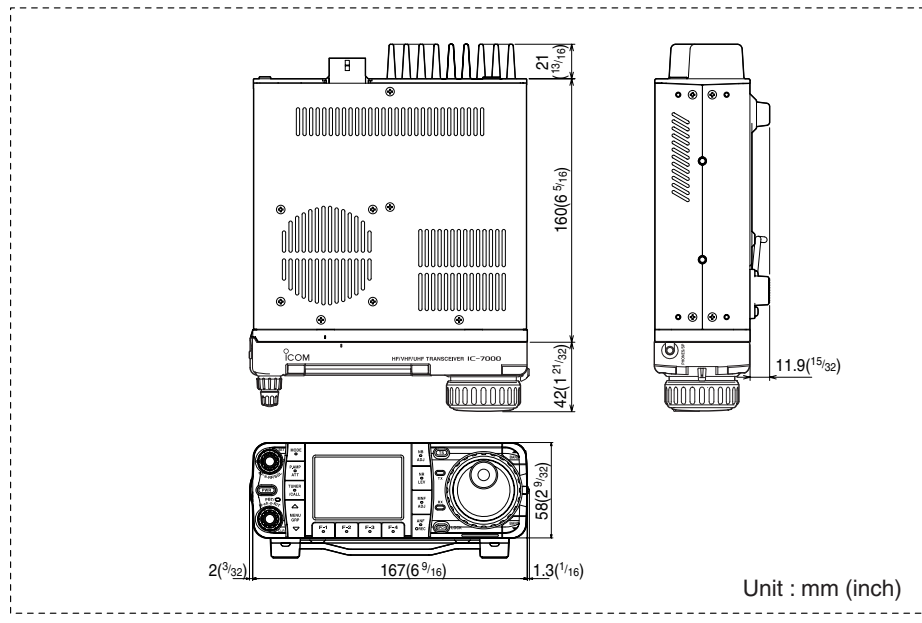

• HM-151

[CHASSIS PARTS]

REF. NO.	ORDER NO.	DESCRIPTION	QTY.
W1	8900011270	Cable OPC-1153	1
MP1	8210021920	2839 front panel (C)	1
MP2	8210018840	2539 rear panel	1
MP3	8930057380	2539 PTT button	1
MP4	8930057390	2539 LED lens	2
MP5	8930057570	2539 SW rubber	1
MP6	8930066540	2539 keyboard (C)	1
MP8	8810009370	Screw PH BT M3 × 12 ZK	2
MP9	8810009560	Screw PH BT M2 × 6 ZK	3

[MAIN UNIT]

REF. NO.	ORDER NO.	DESCRIPTION	QTY.
J1	6510023110	Connector 3008L-8P8C	1
S1	2260000980	Switch SKHHLP014A	1
MC1	7700002310	Microphone EM-140	1

Screw abbreviations
 BT: Self-tapping
 PH: Pan head
 ZK: Black

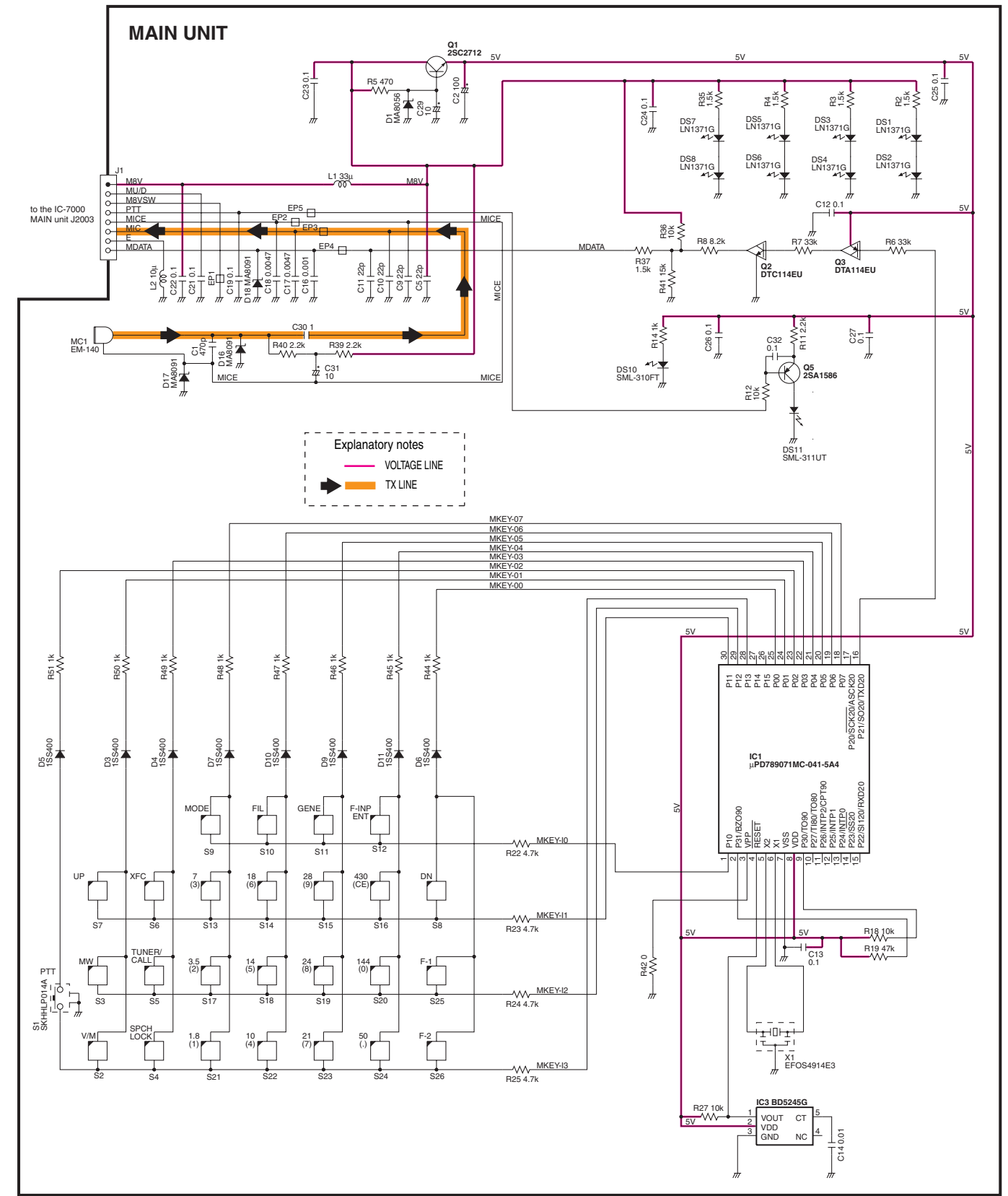
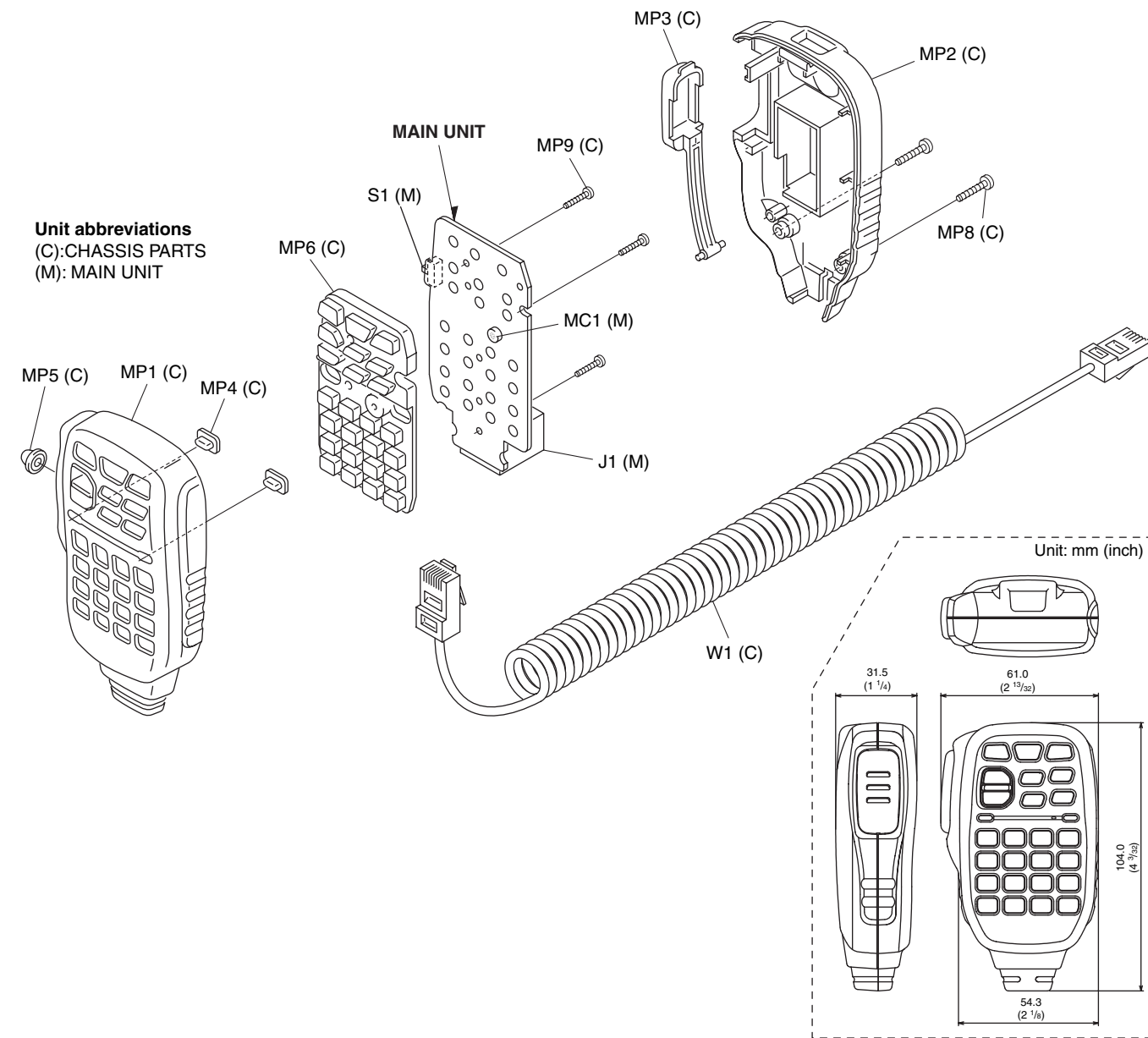







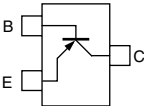
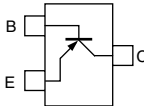
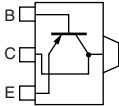
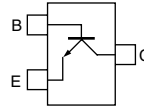
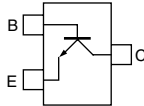
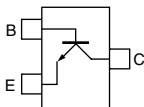
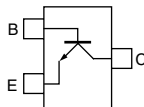
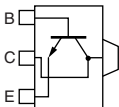
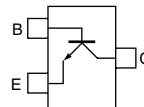
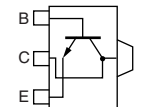
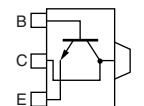
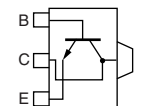
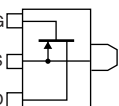
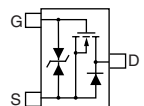
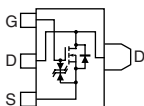
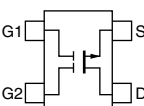
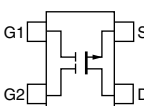
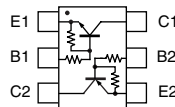
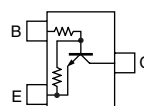
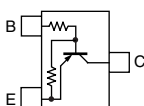
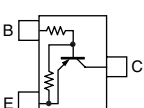
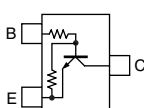
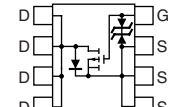
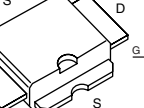
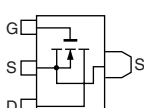
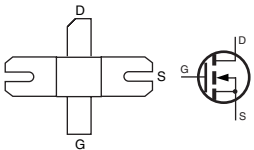
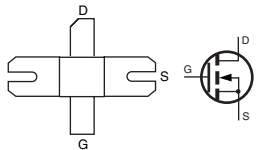
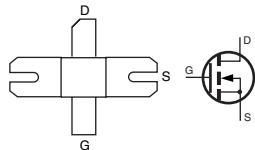
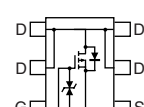
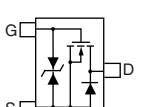
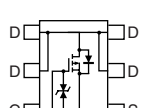
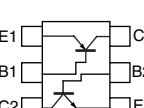



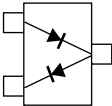

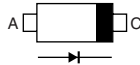
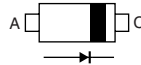
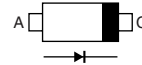
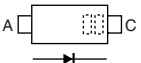
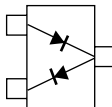
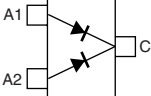
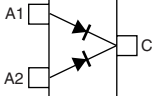
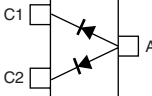
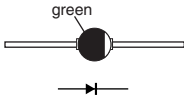
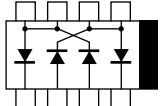
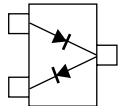

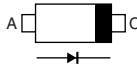
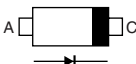

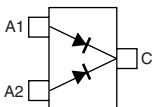
SECTION 7

SEMI-CONDUCTOR INFORMATION

• TRANSISTORS AND FET'S

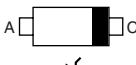
<p>2SA1576A T106 R (Symbol: FR)</p> 	<p>2SA1586 GR (Symbol: SG)</p> 	<p>2SB1132 T100 R (Symbol: BAR)</p> 	<p>2SC4081 T106 R (Symbol: BR)</p> 	<p>2SC4213 B (Symbol: AB)</p> 
<p>2SC4215 Y (Symbol: QY)</p> 	<p>2SC4403 3 TL (Symbol: LY3)</p> 	<p>2SC4673 D TD (Symbol: CO)</p> 	<p>2SC5226 4 TL (Symbol: LN4)</p> 	<p>2SC5551 (Symbol: EB)</p> 
<p>2SD1619 T TD (Symbol: DB)</p> 	<p>2SD1623 TD (Symbol: DF)</p> 	<p>2SK2854 (Symbol: UP)</p> 	<p>2SK3018 T106 (Symbol: KN)</p> 	<p>2SK3065 T100 (Symbol: KE)</p> 
<p>3SK195 (Symbol: UJ)</p> 	<p>3SK291 (Symbol: UF)</p> 	<p>BCR08PN (Symbol: WFs)</p> 	<p>BCR108T (Symbol: WHs)</p> 	<p>BCR183T (Symbol: WMs)</p> 
<p>DTA114 EE TL (Symbol: 14)</p> 	<p>DTC114EUA T106 (Symbol: 24)</p> 	<p>ECH8301-TL (Symbol: JA)</p> 	<p>PD55015 (Symbol: PD55015)</p> 	<p>RD01MUS1 (Symbol: K2)</p> 
<p>RD60HUF1 (Symbol: RD60HUF1)</p> 	<p>RD70HHF1 (Symbol: RD70HH01)</p> 	<p>RD70HVF1 (Symbol: RD70HVF1)</p> 	<p>RSQ035P03 (Symbol: TM)</p> 	<p>RSR025N03 (Symbol: QY)</p> 
<p>RTQ035P02 (Symbol: TL)</p> 	<p>XP4601 (Symbol: 5C)</p> 			

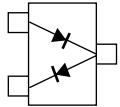
• DIODES

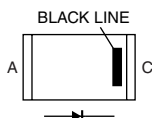
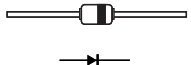
<p>1SS302 (Symbol: C3)</p> 	<p>1SV271 (Symbol: TG)</p> 	<p>1SV305 (Symbol: TV)</p> 	<p>1SV307 (Symbol: TX)</p> 	<p>1SV308 (Symbol: TX)</p> 
<p>CUS02 (Symbol: 2)</p> 	<p>DA221 TL (Symbol: K)</p> 	<p>DAN202 K T146 (Symbol: N)</p> 	<p>DAN202 U T106 (Symbol: N)</p> 	<p>DAP202K T146 (Symbol: P)</p> 
<p>DSA3A1 (Color: Green)</p> 	<p>HSB88WSTR (Symbol: Silver line)</p> 	<p>HSM88AS TR (Symbol: C1)</p> 	<p>MA2S111 (Symbol: A)</p> 	<p>MA2S728 (Symbol: B)</p> 
<p>MA2SD10 (Symbol: 2L)</p> 	<p>MA2SV05 (Symbol: 3A)</p> 	<p>MA357 (Symbol: 7K)</p> 	<p>MA717 WK (Symbol: M3D)</p> 	<p>MA728 (Symbol: 2A)</p> 
<p>MA729 (Symbol: 2B)</p> 	<p>MA732 (Symbol: 2C)</p> 	<p>MA77 (Symbol: 4B)</p> 	<p>MA8036 L (Symbol: 3_6)</p> 	<p>MA8039 L (Symbol: 3_9)</p> 
<p>MA8043 L (Symbol: 4_3)</p> 	<p>MA8047 M (Symbol: 4-7)</p> 	<p>MA8075 L (Symbol: 7_5)</p> 	<p>RB706F-40 T106 (Symbol: 3J)</p> 	<p>SM240A-T (Symbol: 240A)</p> 
<p>UM9401F (Symbol: none)</p> 	<p>XB15A407 (Symbol: none)</p> 			

• BOTTOM VIEW (DISPLAY UNIT)

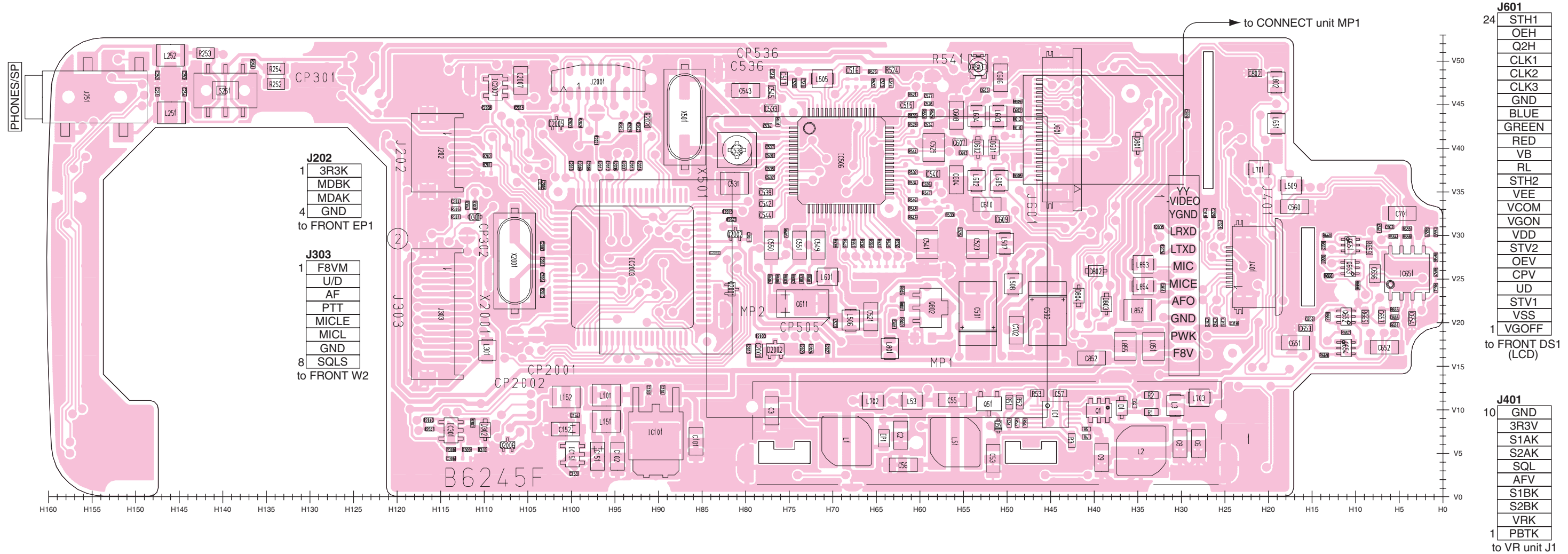

• BOTTOM VIEW (VR UNIT)

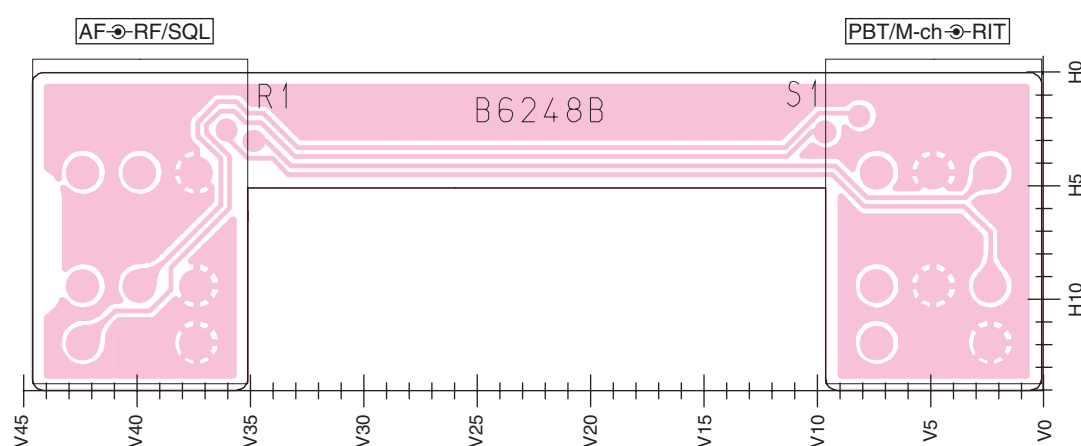

8-3 MAIN UNIT
• TOP VIEW

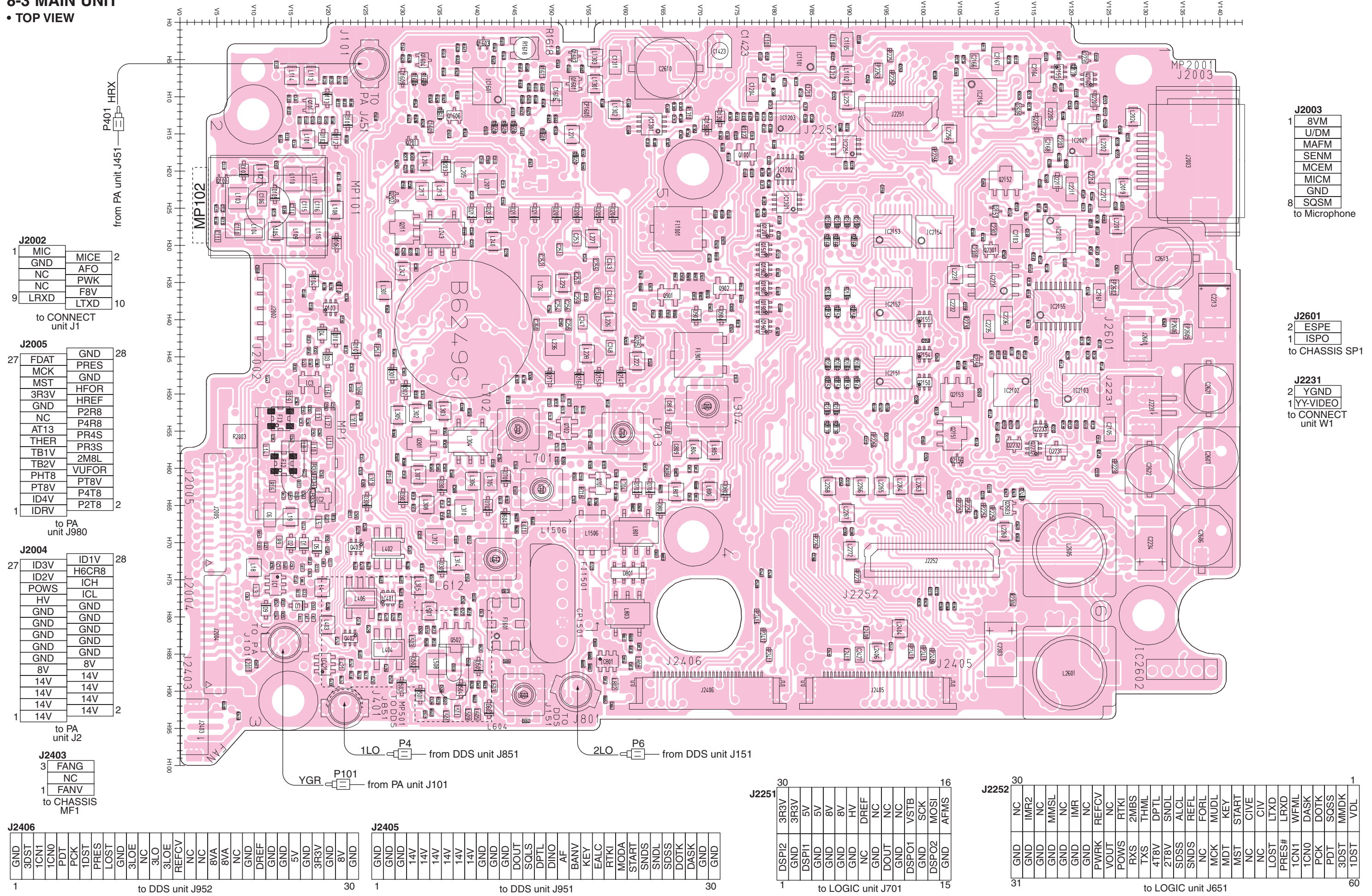

J2002

1	MIC	MICE	2
	GND	AFO	
	NC	PWK	
	NC	F8V	
9	LRXD	LTXD	10

to CONNECT unit J1

J2005

27	FDAT	GND	28
	MCK	PRES	
	MST	GND	
	3R3V	HFOR	
	GND	P2R8	
	NC	P4R8	
	AT13	PR4S	
	THER	PR3S	
	TB1V	2M8L	
	TB2V	VUFOR	
	PT8V	PT8V	
	ID4V	P4T8	2
1	IDRV	P2T8	

to PA unit J980

J2004

27	ID3V	ID1V	28
	ID2V	H6CR8	
	POWS	ICH	
	HV	ICL	
	GND	GND	
	GND	GND	
	GND	GND	
	GND	GND	
	GND	GND	
	8V	8V	
	14V	14V	
	14V	14V	
	14V	14V	
1	14V	14V	2

to PA unit J2

J2403

3	FANG	
	NC	
1	FANV	

to CHASSIS MF1

J2406

GND	3DST	PDT	PCK	1DST	PRES	LOST	GND	3LOE	3LO	3LOE	REFCV	NC	NC	8VA	8VA	NC	GND	DREF	GND	GND	5V	GND	3R3V	GND	8V	GND	
1																											

to DDS unit J952

J2405

GND	GND	14V	14V	14V	14V	14V	14V	GND	GND	GND	DOUT	SOLS	DPTL	DINO	AF	BANV	KEY	EALC	RTKI	MODA	START	SND5	SNDL	SDSS	DOTK	DASK	GND	
1																												

to DDS unit J951

J2251

30	3R3V	3R3V	5V	5V	8V	8V	HV	DREF	NC	DOUT	NC	DSP01	DSP02	GND	16
1	AFMS	AFMS	AFMS	AFMS	AFMS	AFMS	AFMS	AFMS	AFMS	AFMS	AFMS	AFMS	AFMS	AFMS	AFMS

to LOGIC unit J701

J2252

30	NC	IMR2	NC	MMSL	NC	IMR	NC	REFCV	NC	VOUT	NC	POWS	2MBS	THMT	SXT	DPTL	2T8V	4T8V	SDSS	REFL	FORL	MCK	MDT	MST	CIVE	NC	TXD	LRXD	WFML	ICN0	PCK	3DST	1	
31																																		

to LOGIC unit J651

J2003

1	8VM
	U/DM
	MAFM
	SENM
	MCEM
	MICM
	GND
8	SQSM

to Microphone

J2601

2	ESPE
1	ISPO

to CHASSIS SP1

J2231

2	YGND
1	YY-VIDEO

to CONNECT unit W1

8-4 PA UNIT
• TOP VIEW

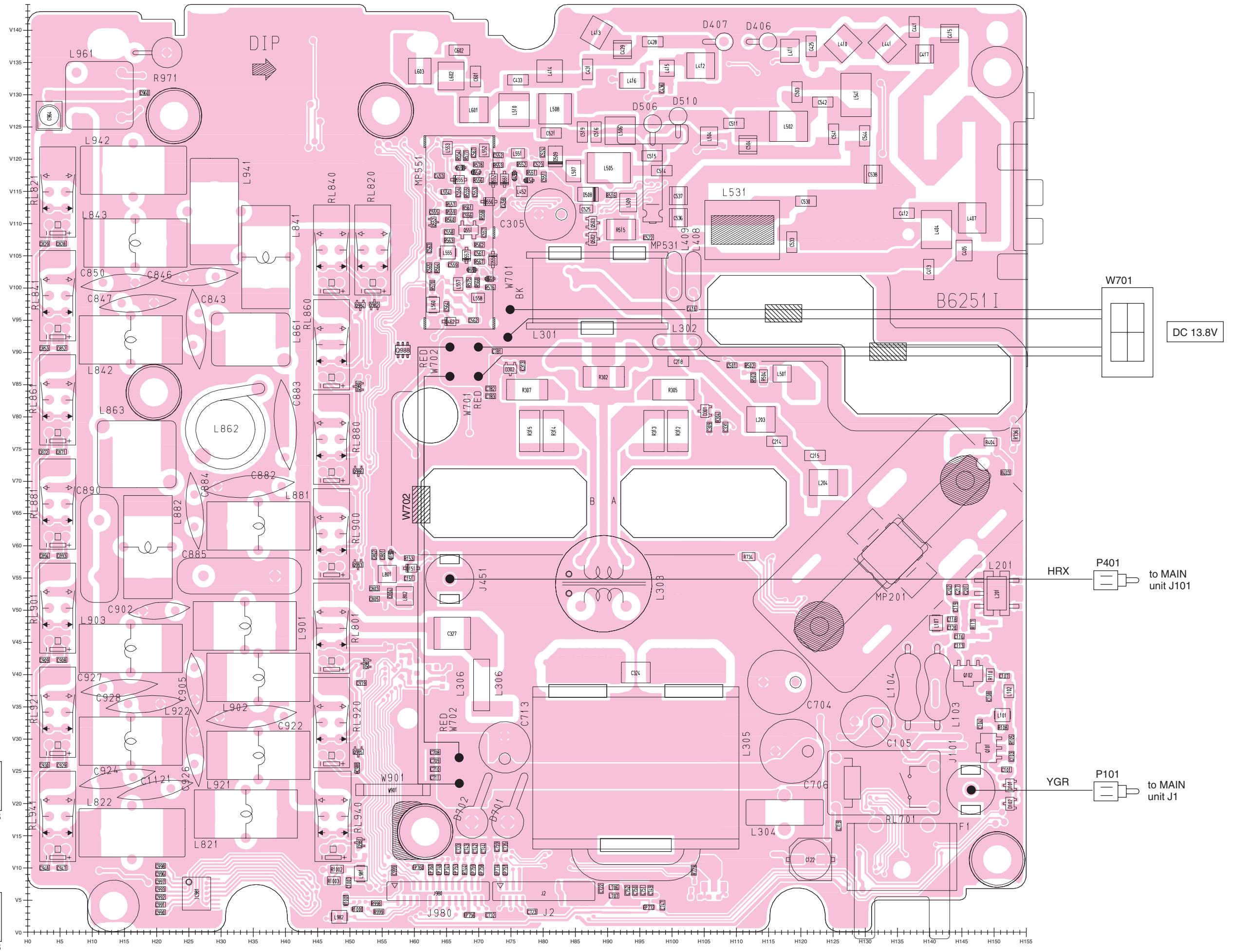

1	ID1V	H6CR8	ICH	ICL	GND	GND	GND	GND	GND	GND	8V	14V	14V	14V	27
2	ID3V	POWS	HV	GND	GND	GND	GND	GND	GND	GND	8V	14V	14V	14V	28
to MAIN unit J2004															
1	GND	PRES	GND	HFOR	HREF	P2R8	P4F8	PR4S	PR3S	2M8L	VUFOR	PT8V	P4T8	P2T8	27
2	FDAT	MCK	MST	3R3V	GND	NC	AT13	THER	TB1V	TB2V	PHT8	PT8V	ID4V	IDRV	28
to MAIN unit J2005															

• BOTTOM VIEW (PA UNIT)

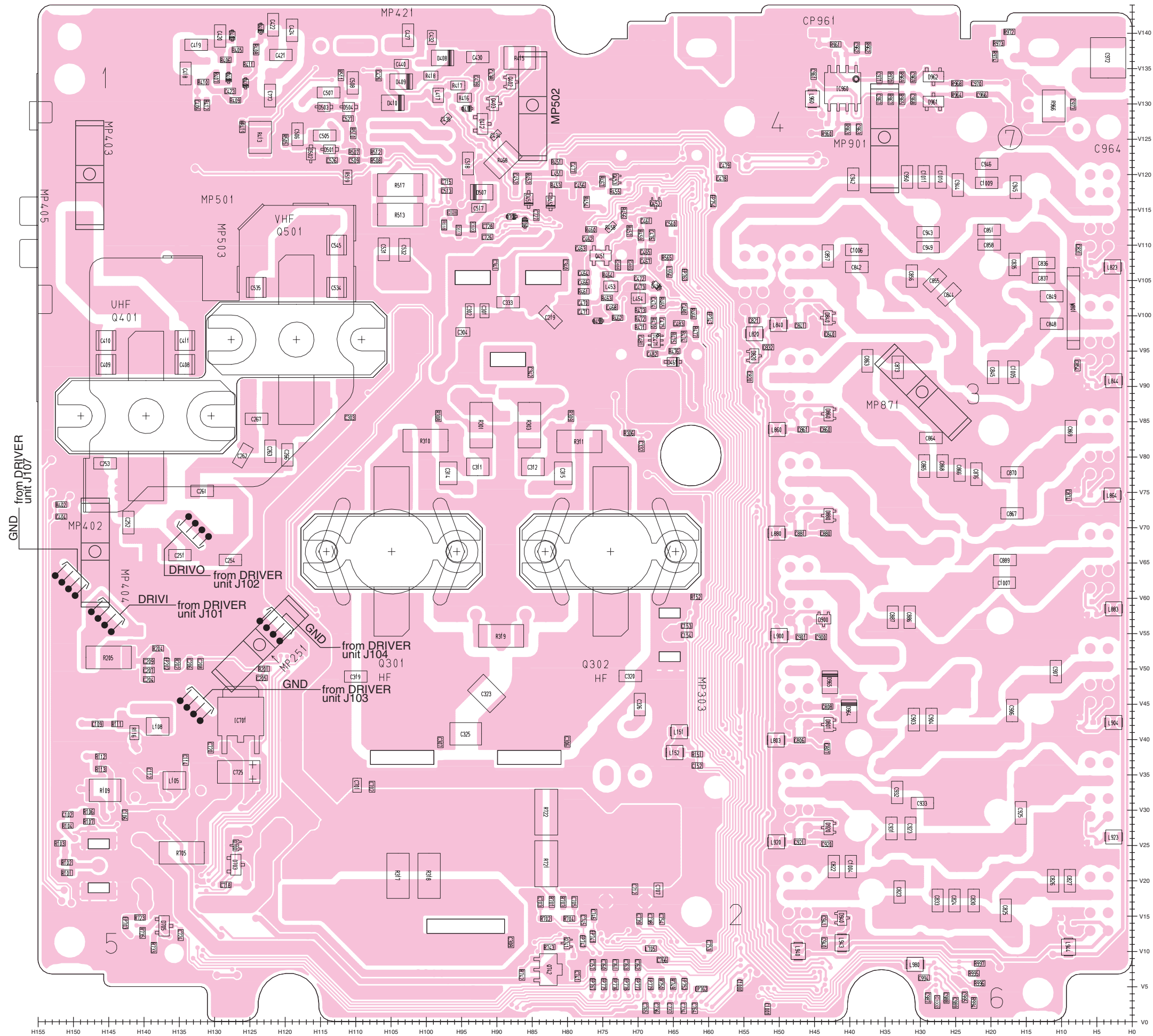

8-5 DDS UNIT
• TOP VIEW

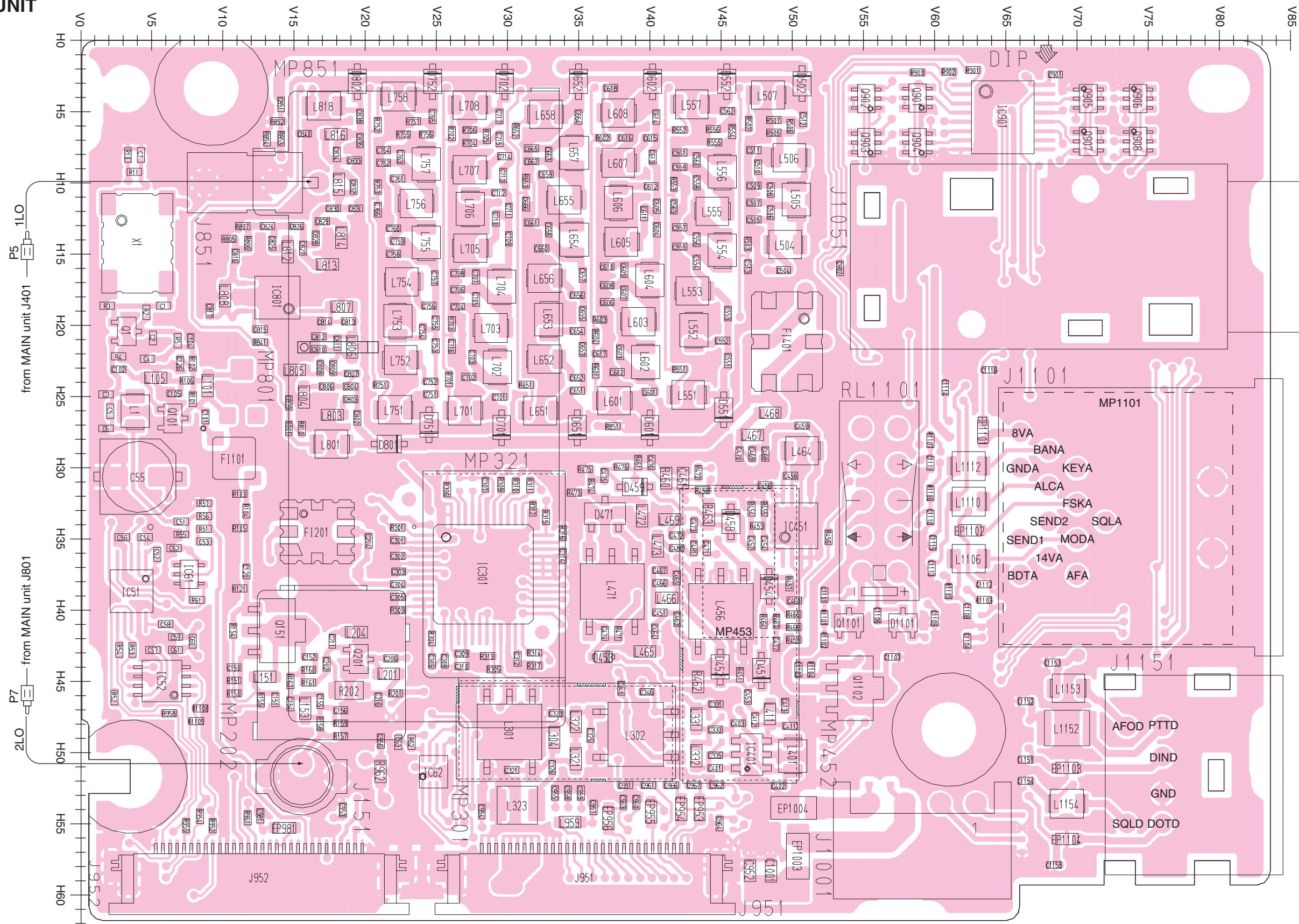

ELE-KEY

ACC

DATA

J952

1	GND
2	GND
3	1SG6
4	1NC1
5	1NC1
6	PDT
7	PCK
8	IDST
9	LOST
10	GND
11	3LOE
12	3LOE
13	3LOE
14	3LOE
15	3LOE
16	3LOE
17	3LOE
18	3LOE
19	3LOE
20	3LOE
21	3LOE
22	3LOE
23	3LOE
24	3LOE
25	3LOE
26	3LOE
27	3LOE
28	3LOE
29	3LOE
30	GND

to MAIN unit J2406

J951

1	GND
2	GND
3	GND
4	1V1
5	1V1
6	1V1
7	1V1
8	1V1
9	1V1
10	1V1
11	1V1
12	1V1
13	1V1
14	1V1
15	1V1
16	1V1
17	1V1
18	1V1
19	1V1
20	1V1
21	1V1
22	1V1
23	1V1
24	1V1
25	1V1
26	1V1
27	1V1
28	1V1
29	1V1
30	GND

to MAIN unit J2405

J1001

4	ETE
3	ET14
2	ETST
1	ETKY

to CHASSIS W11 (TUNER)

8-6 LOGIC UNIT
• TOP VIEW

J2101

1	3V	EMU	2
	GND	TMS	
	GND	TCK	
	TDO	TRST	
9	GND	TDI	10

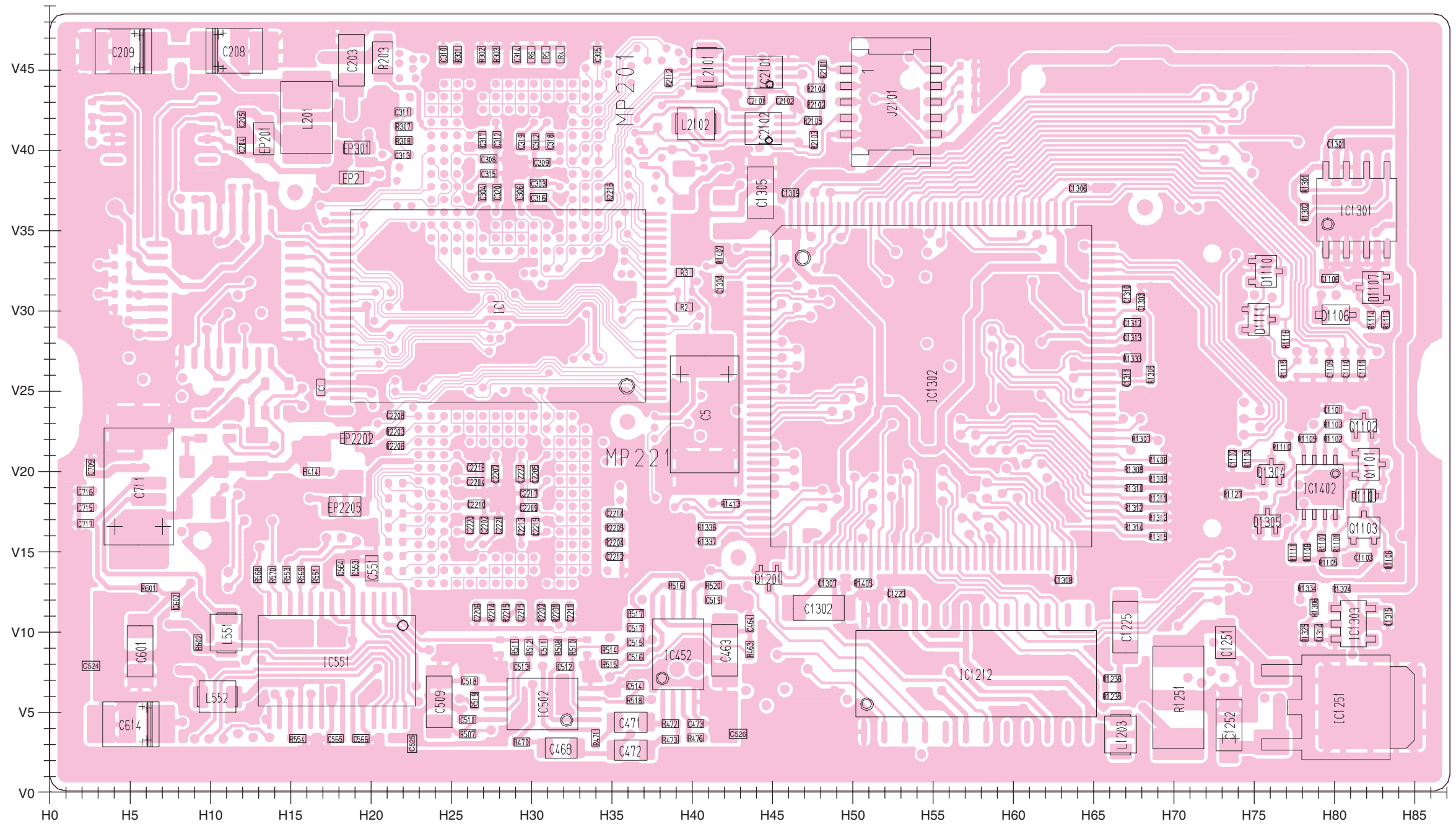

8-7 CONNECT UNIT

• TOP VIEW

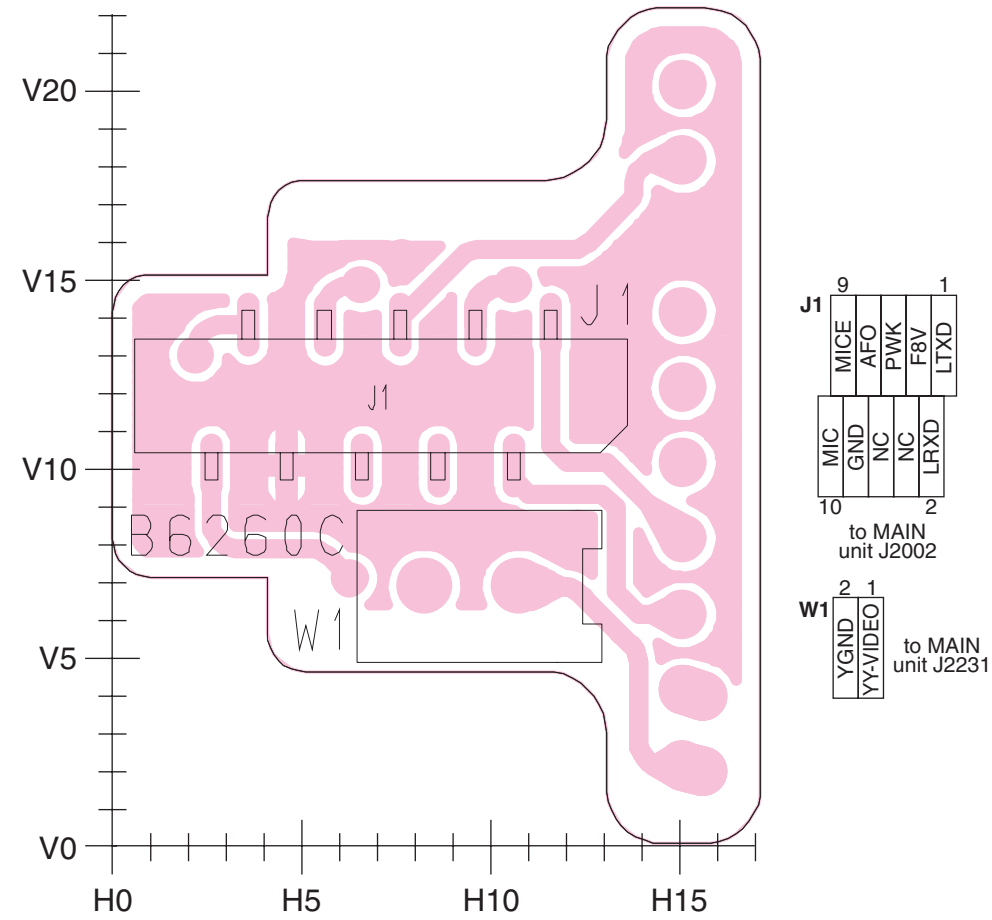

8-8 DRIVER UNIT

• TOP VIEW

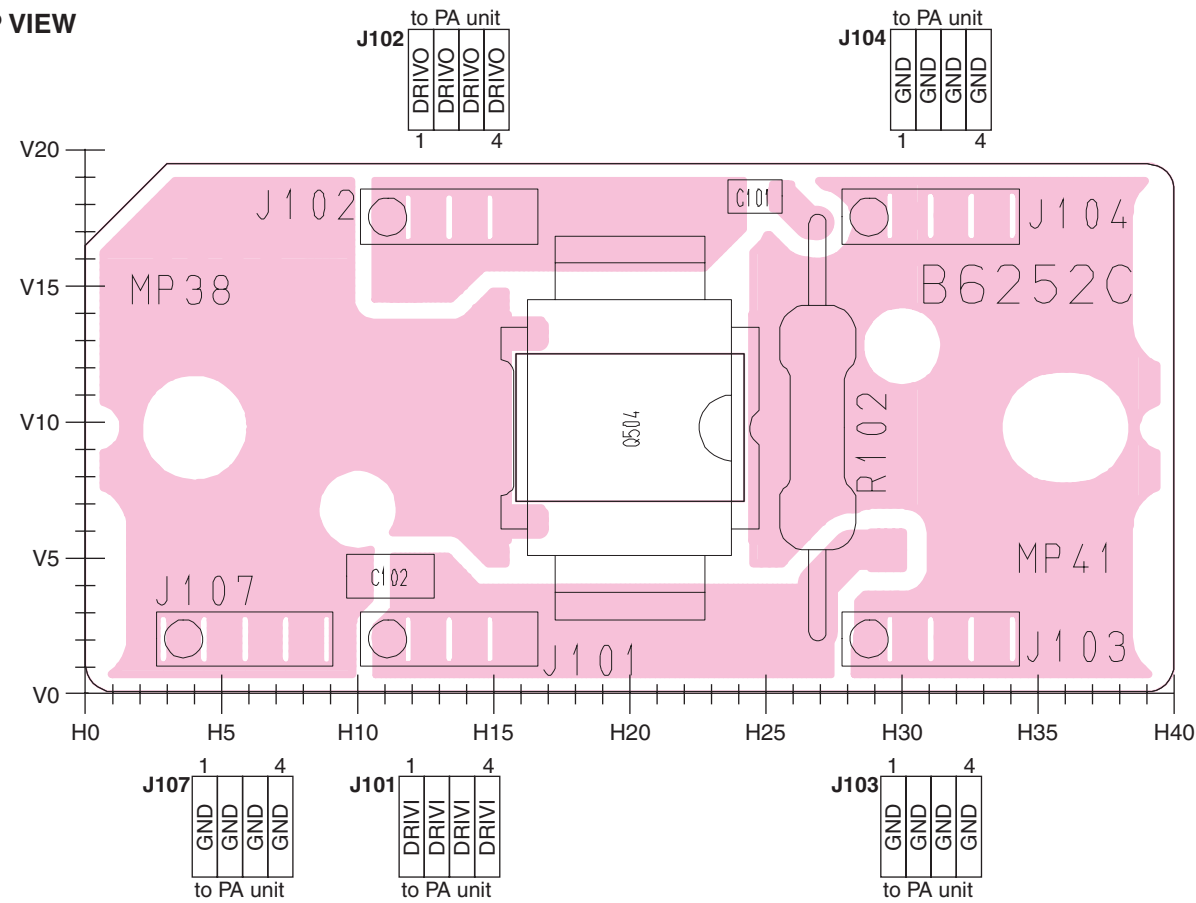

8-9 HM-151

• TOP VIEW

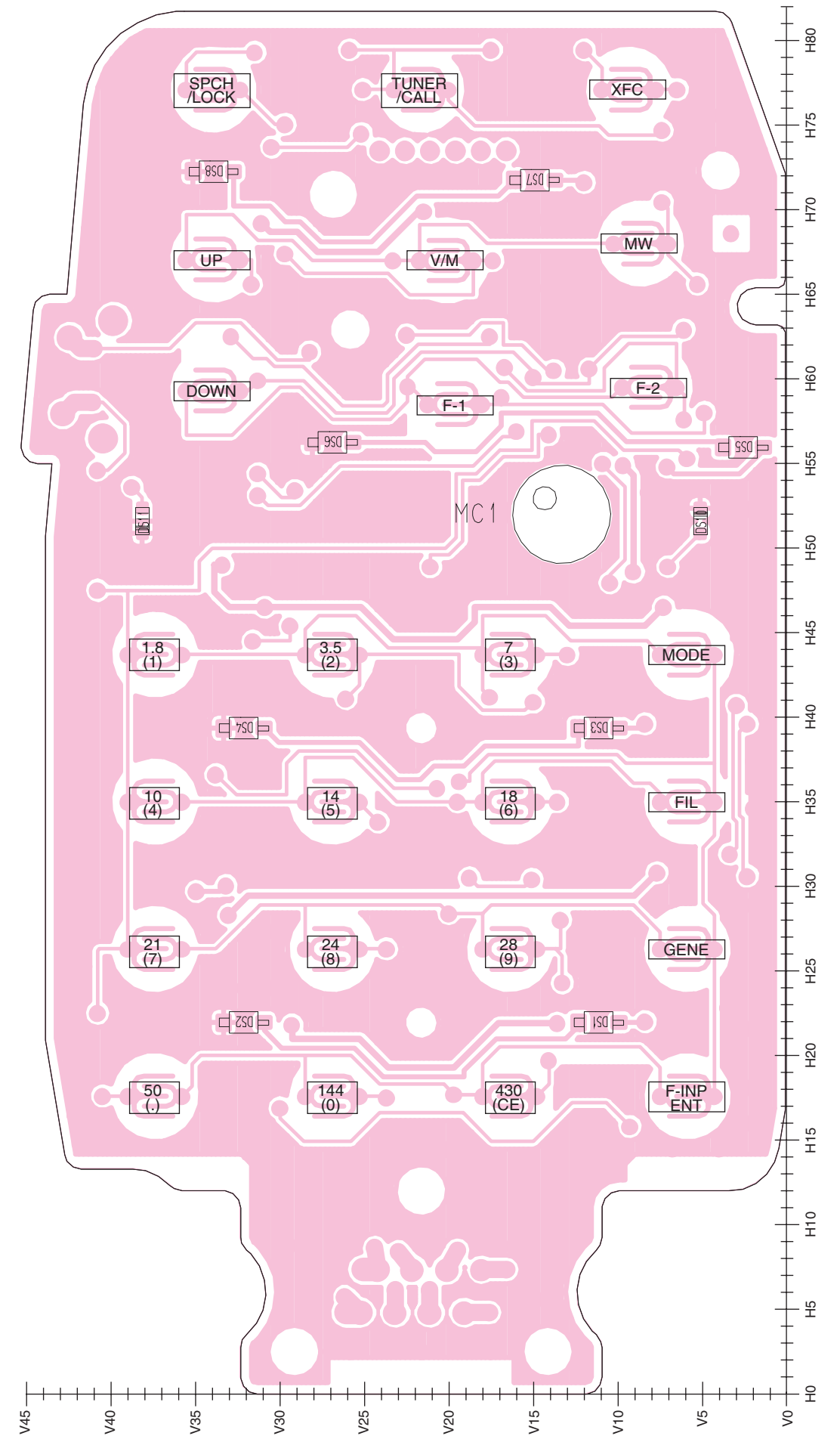

• BOTTOM VIEW (HM-151)

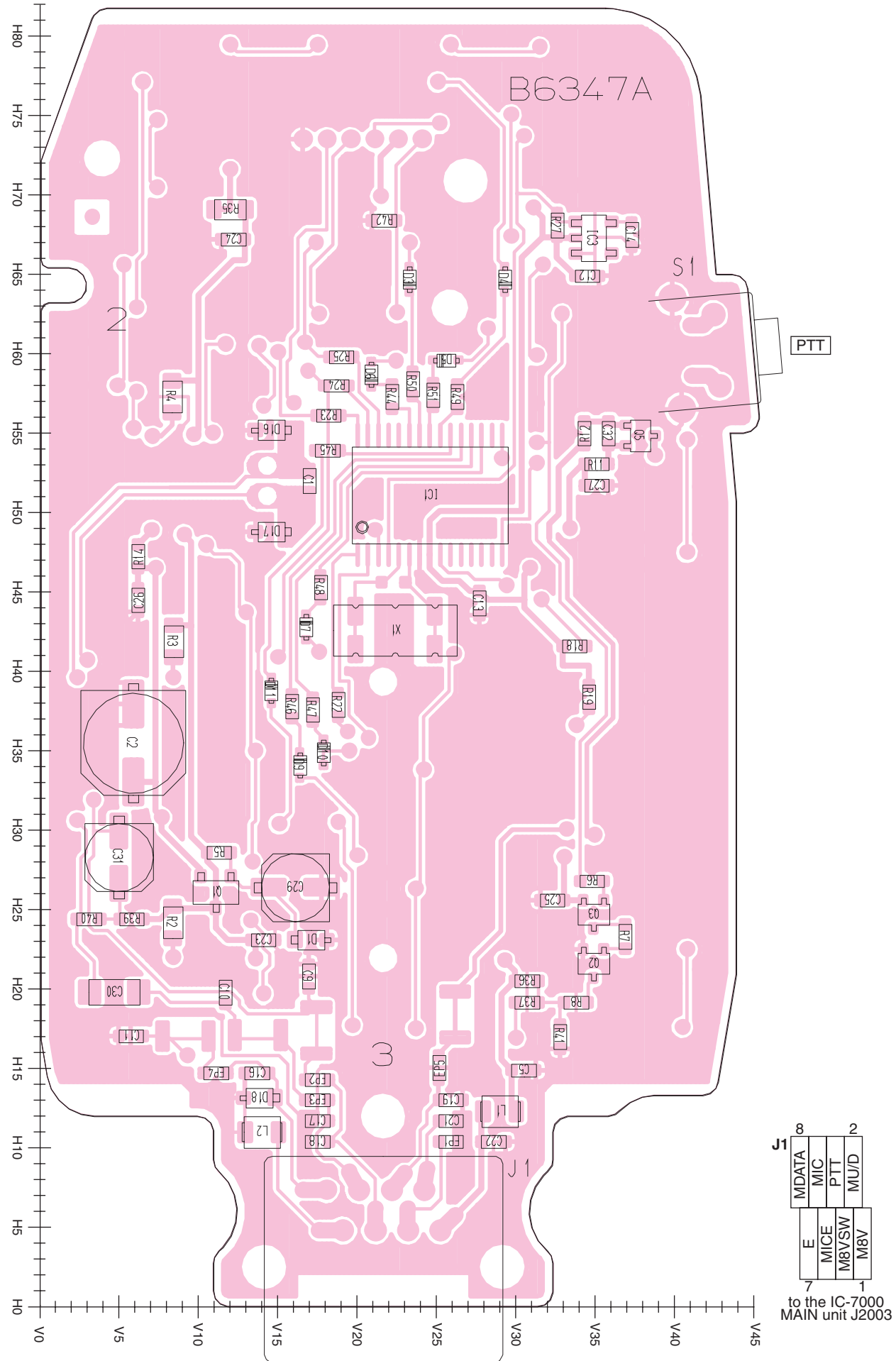

• BOTTOM VIEW (CONNECT UNIT)

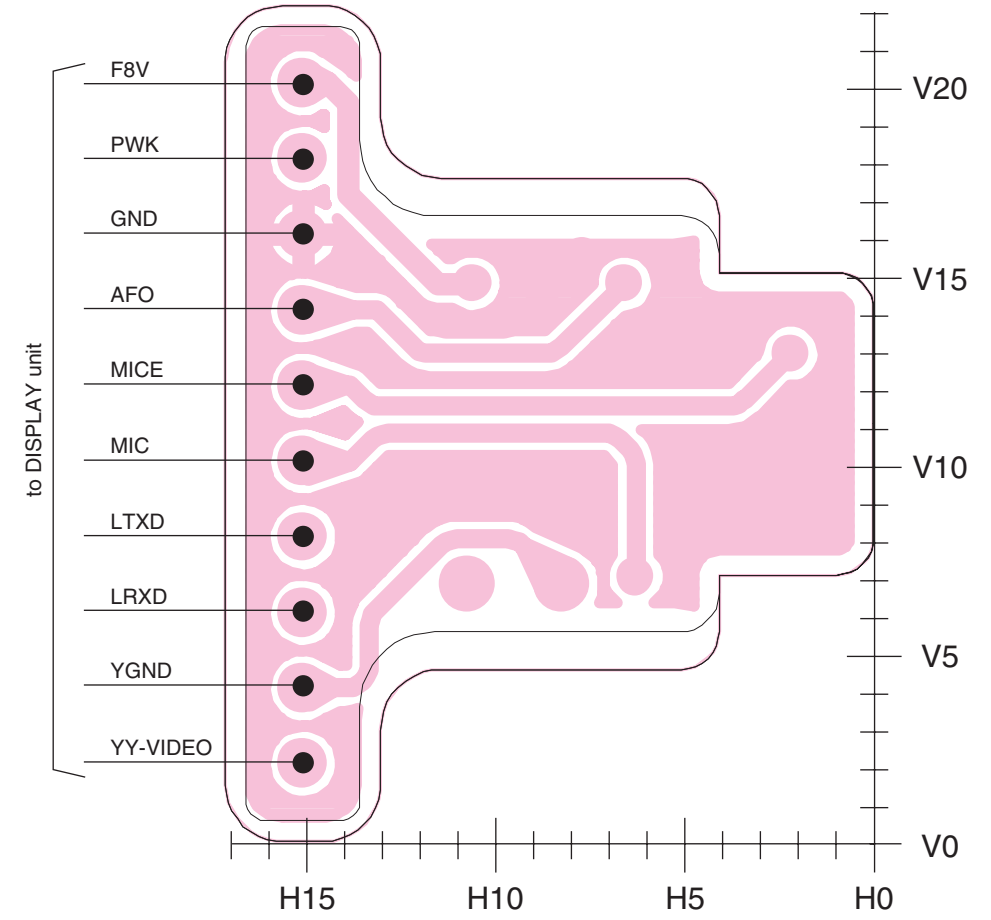

• BOTTOM VIEW (DRIVER UNIT)

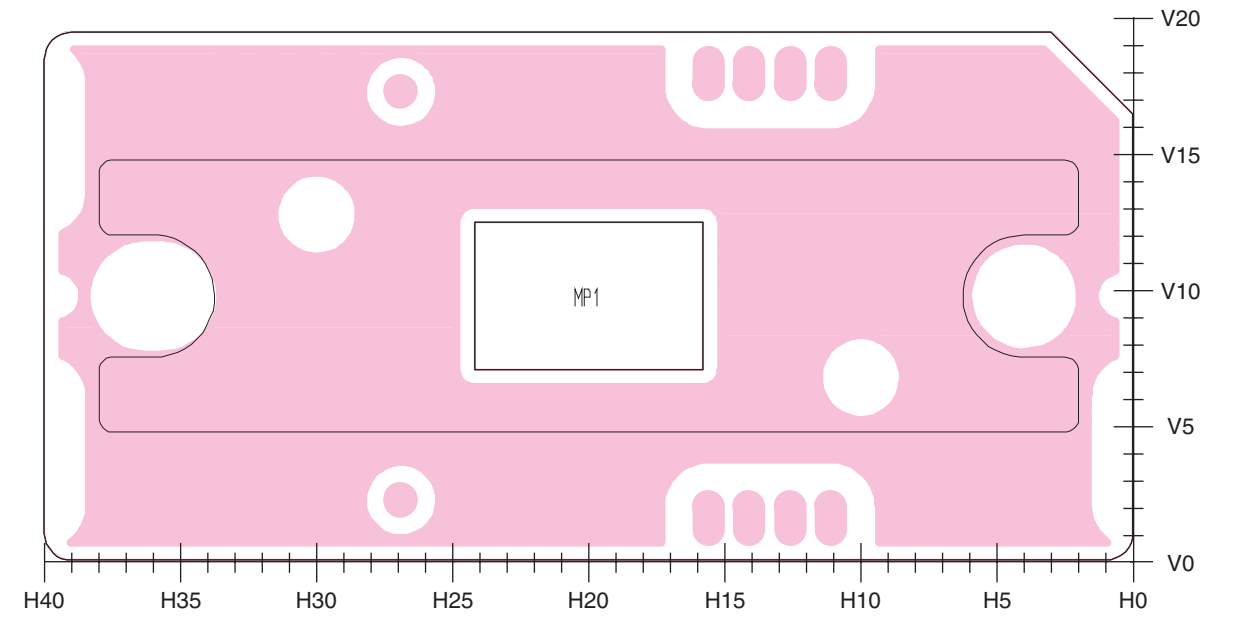

SECTION 9 WIRING DIAGRAM

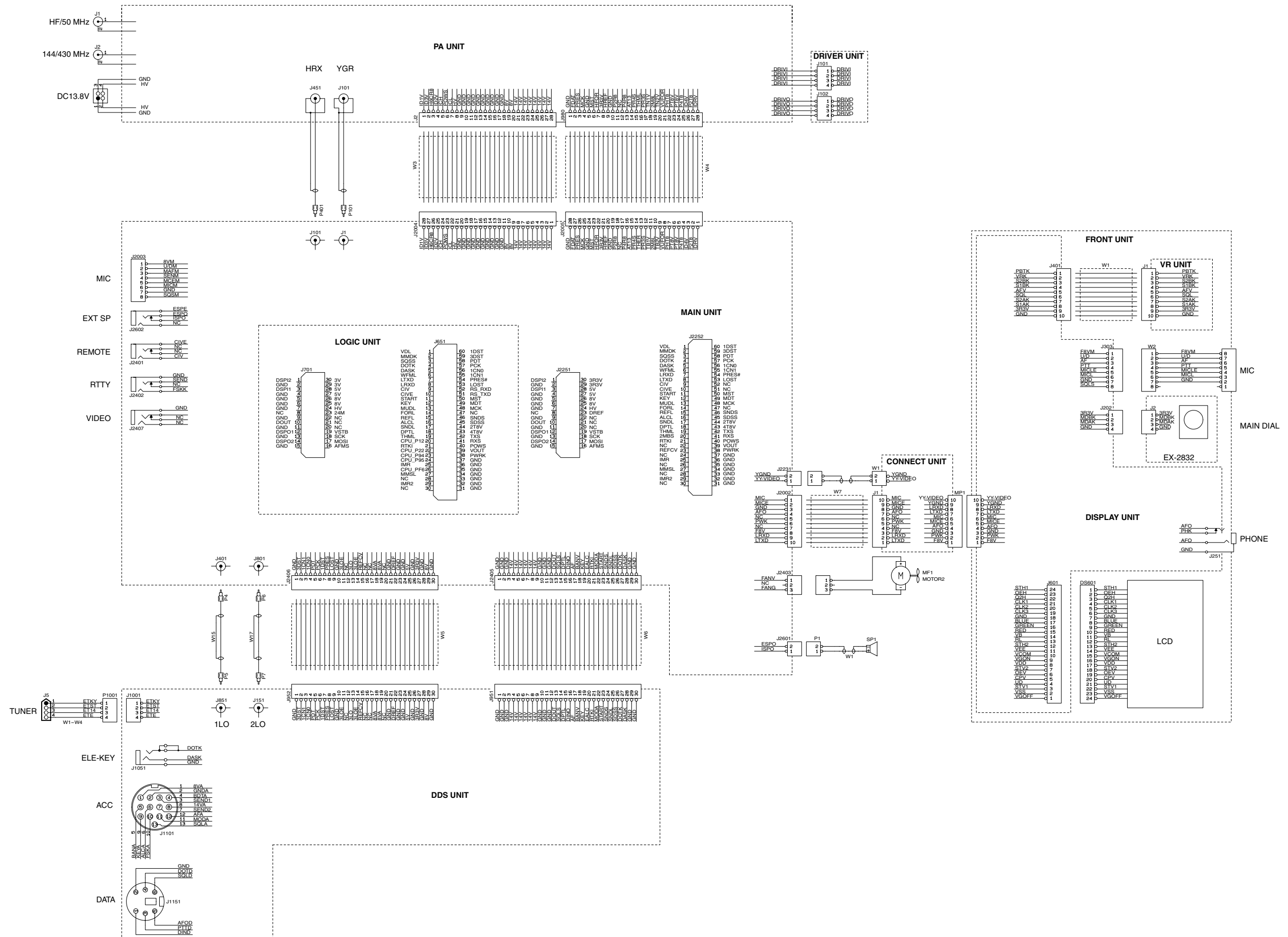

SECTION 11 CIRCUIT DIAGRAMS

11-1 DISPLAY/VR/CONNECT UNITS

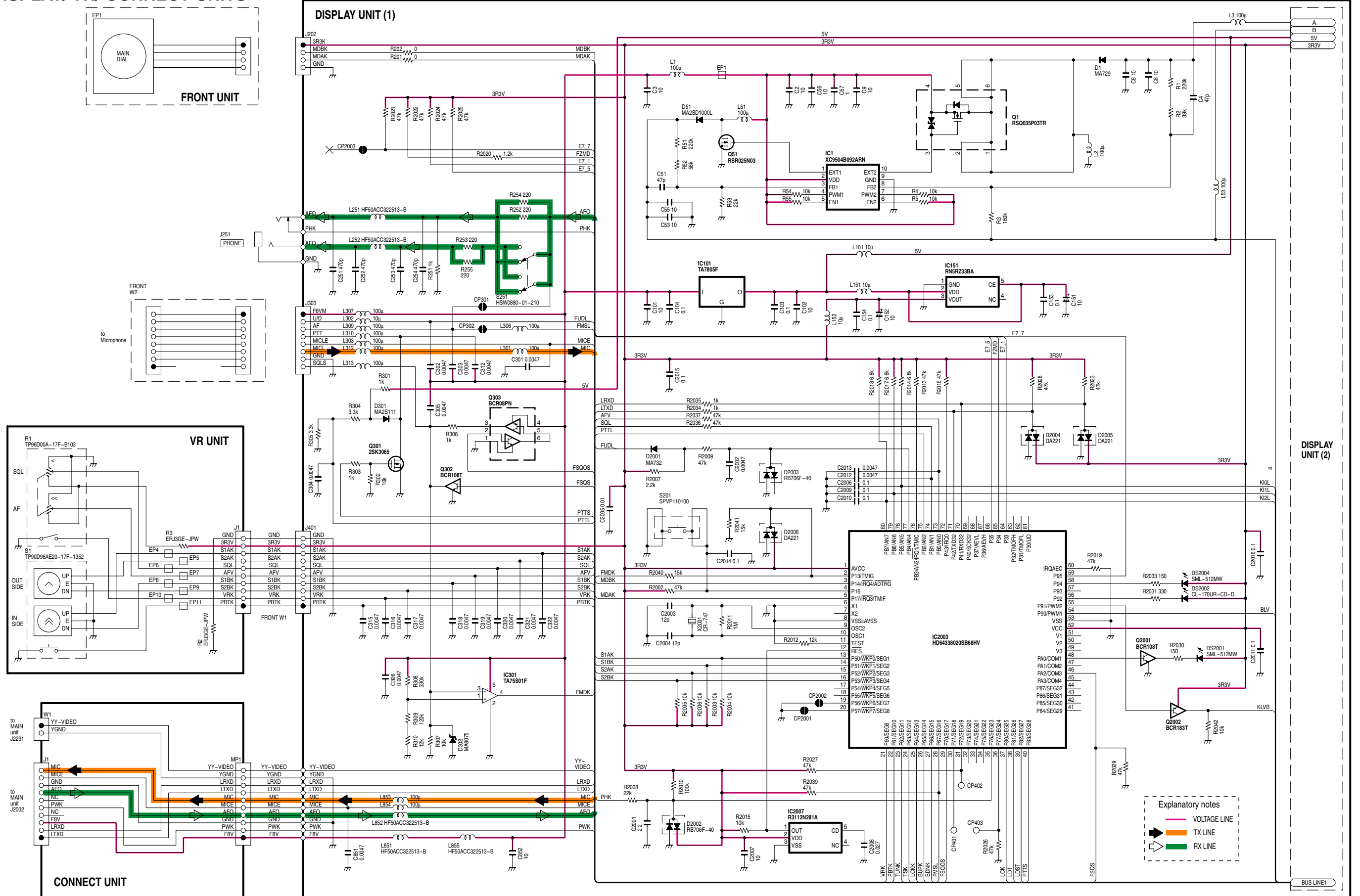

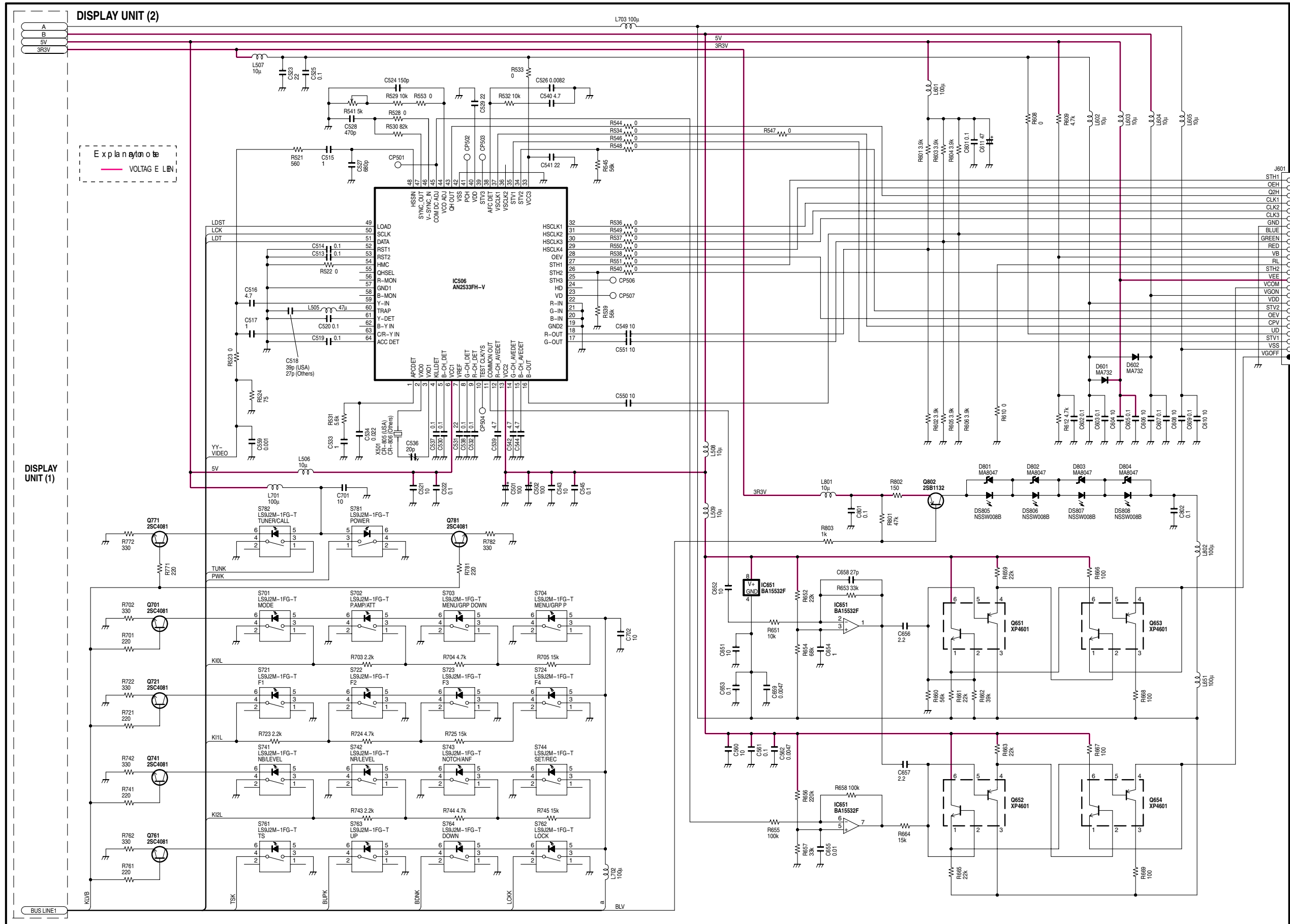

- FRONT**
- DS1
 - STH1
 - OEH
 - Q2H
 - CLK1
 - CLK2
 - CLK3
 - GND
 - BLUE
 - GREEN
 - RED
 - VB
 - RL
 - STH2
 - VEE
 - VCOM
 - VGON
 - VDD
 - STV2
 - OEV
 - CPV
 - UD
 - STV1
 - VSS
 - VGOFF
- LCD**

11-2 MAIN UNIT

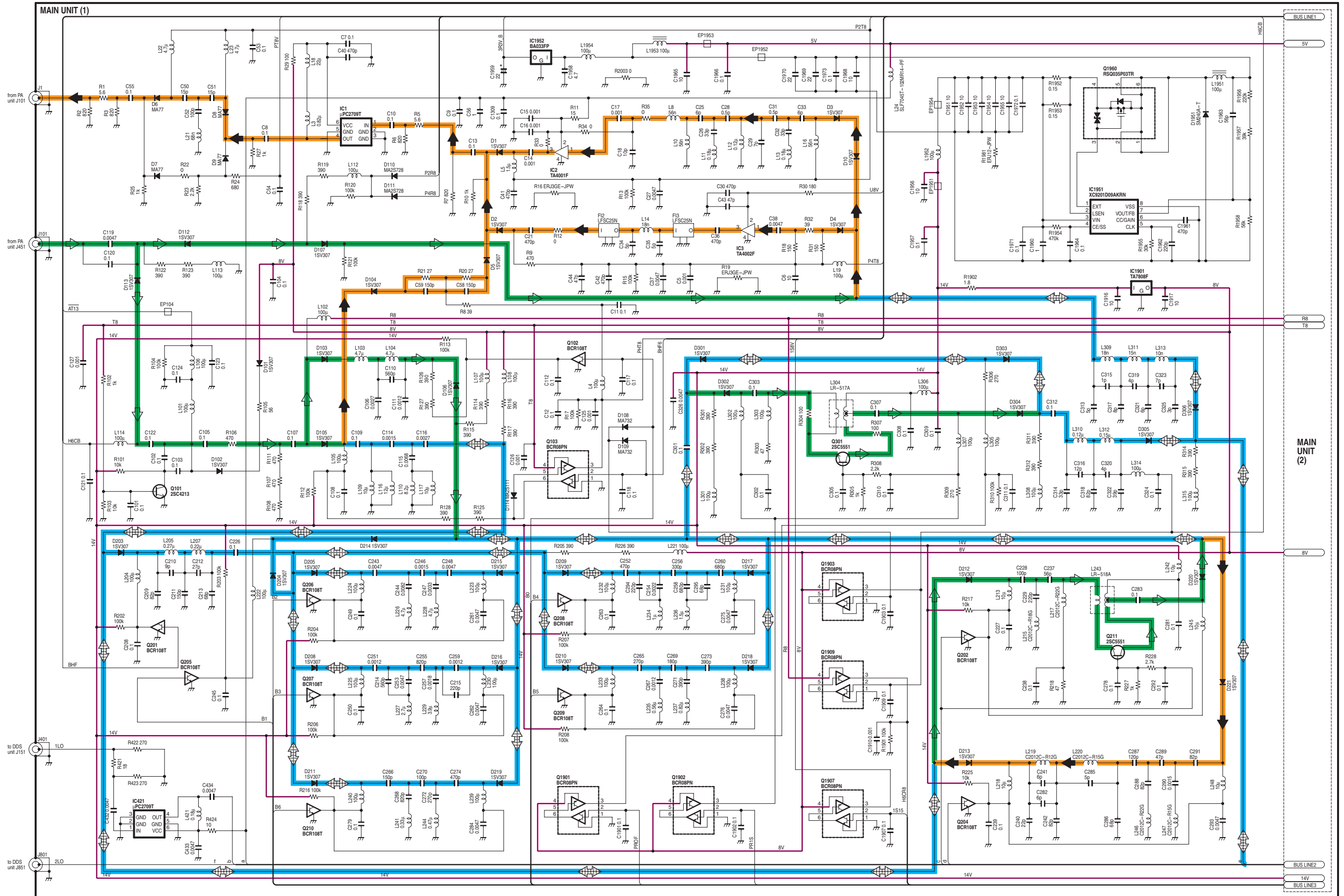

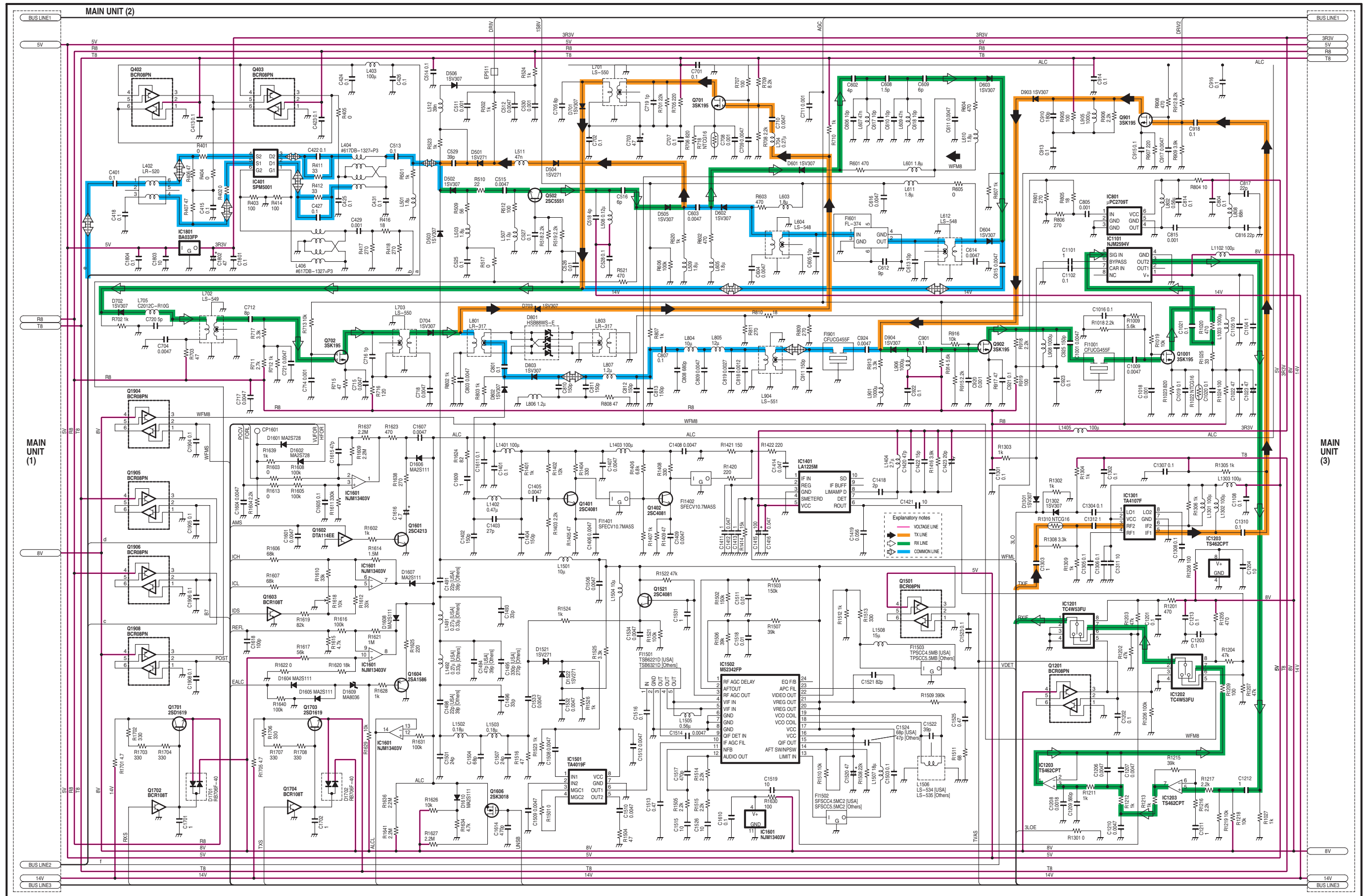

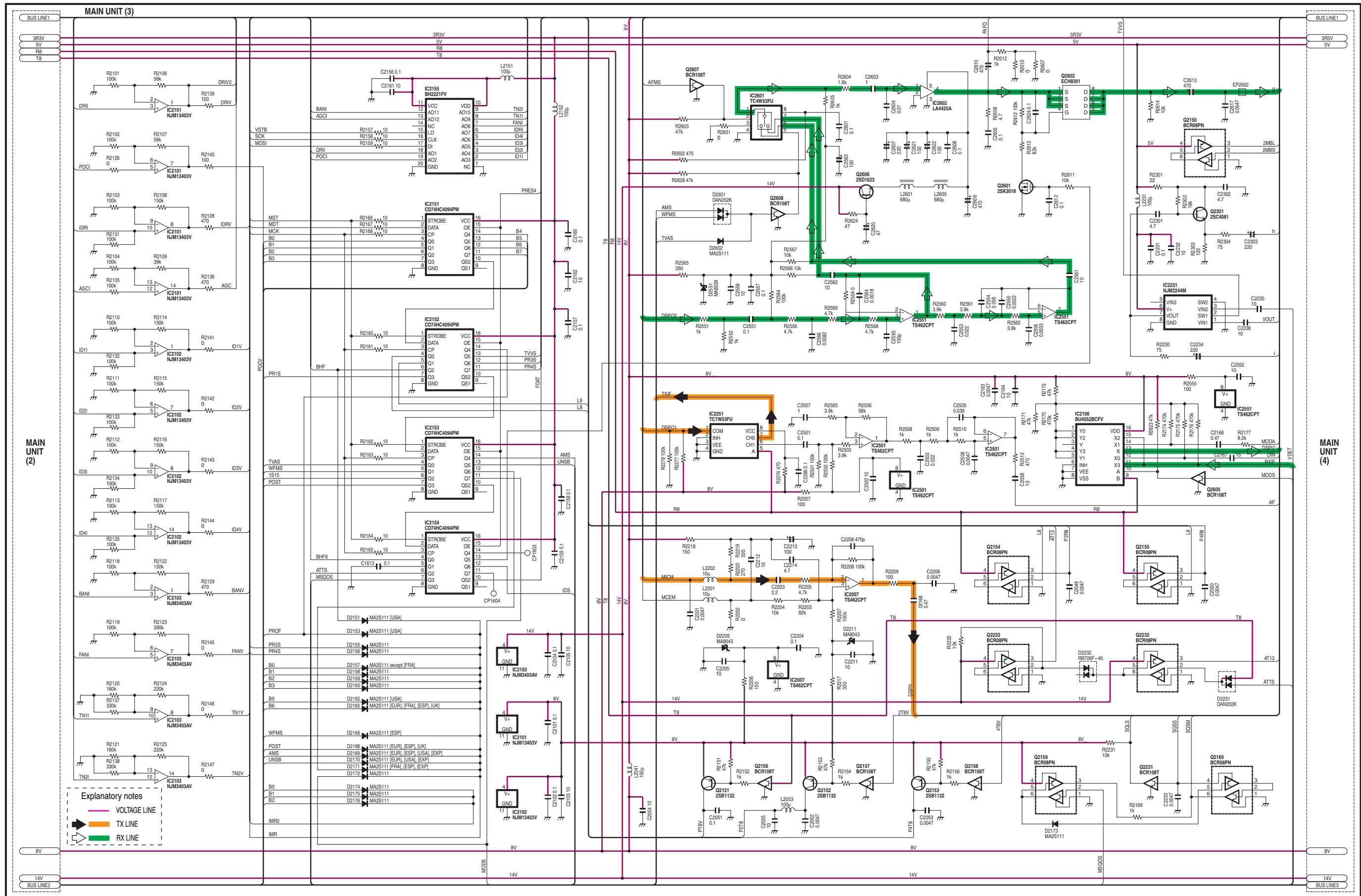

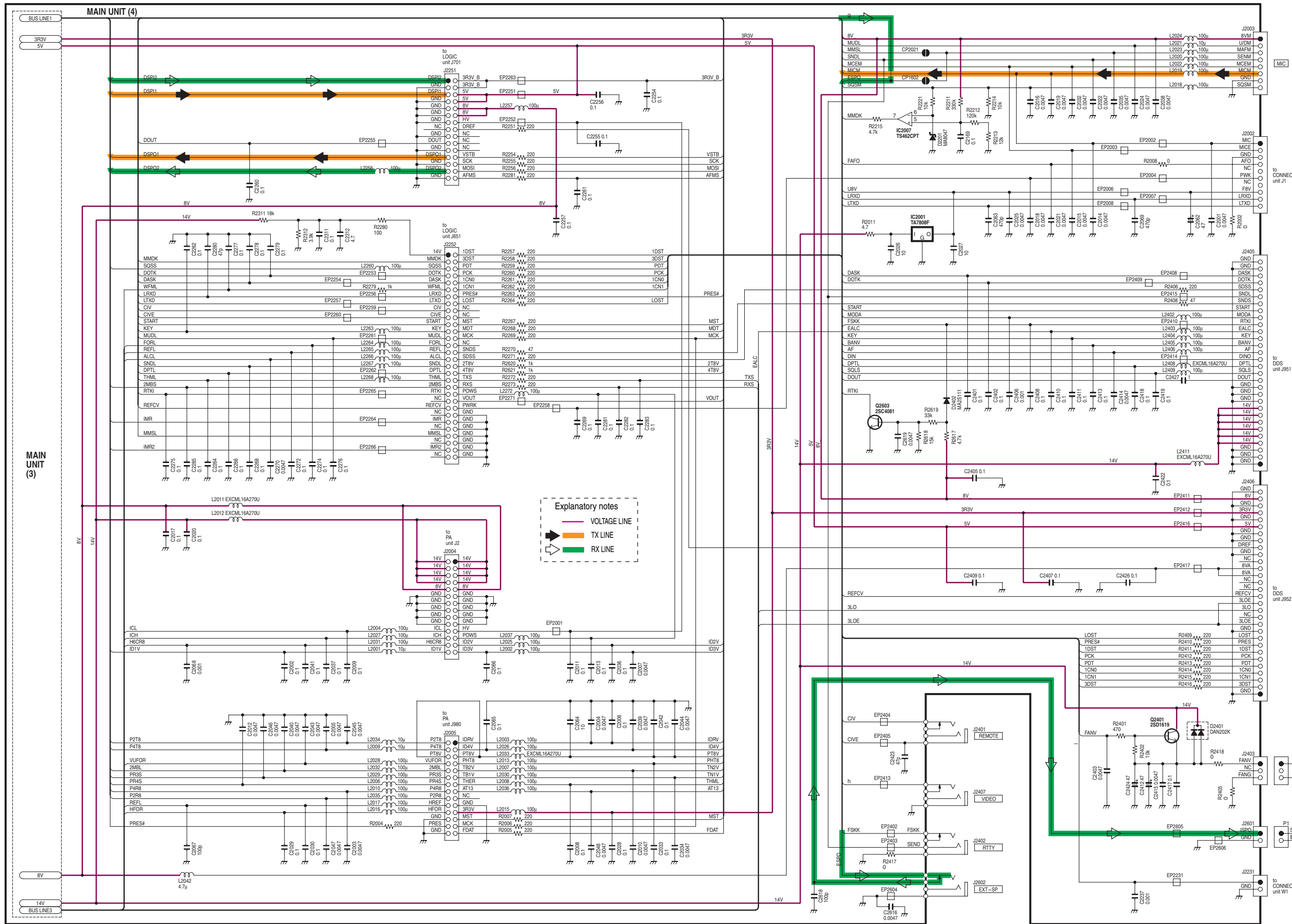

Explanatory notes

- VOLTAGE LINE
- TX LINE
- RX LINE

11-3 LOGIC UNIT

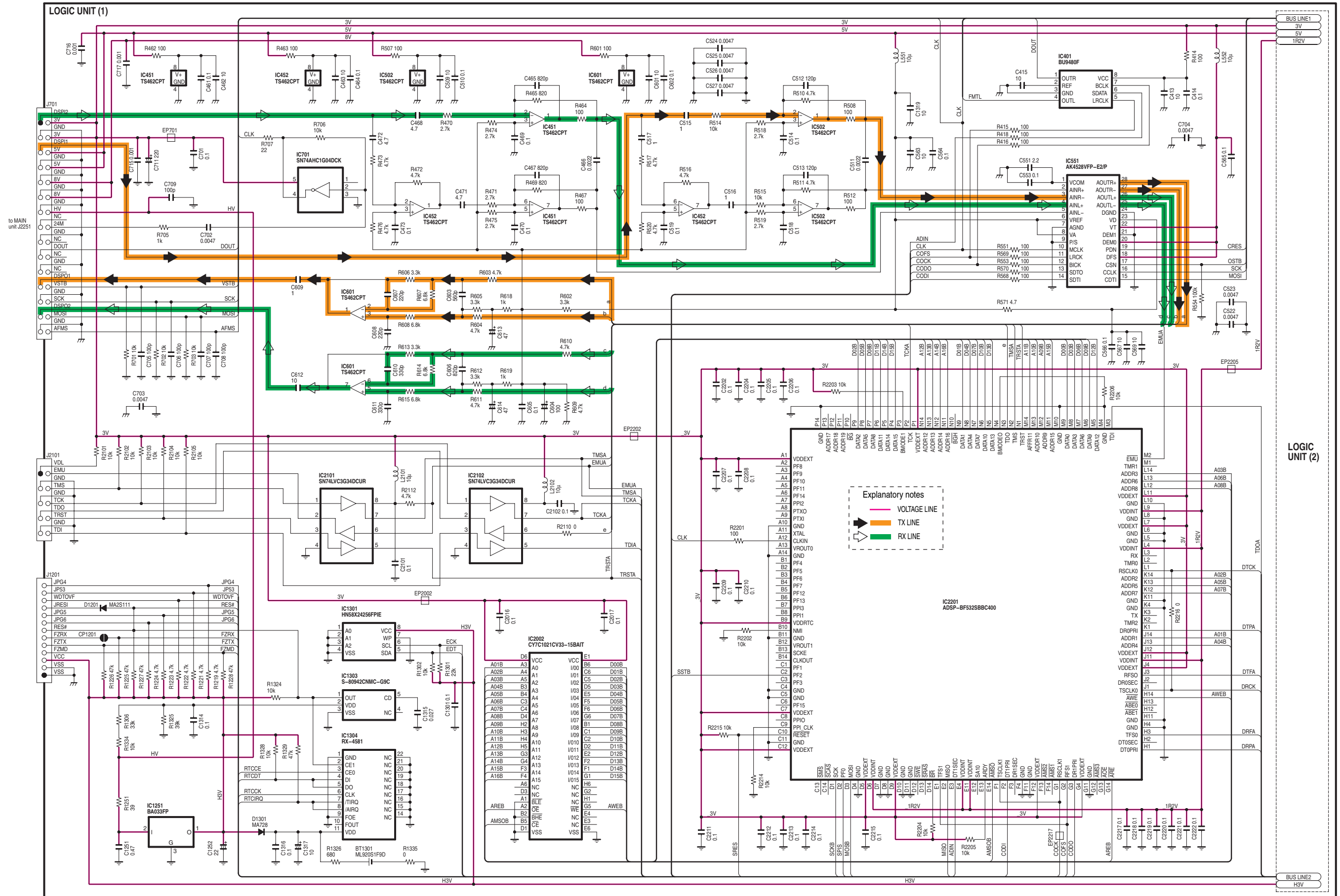

11-4 PA/DRIVER UNITS

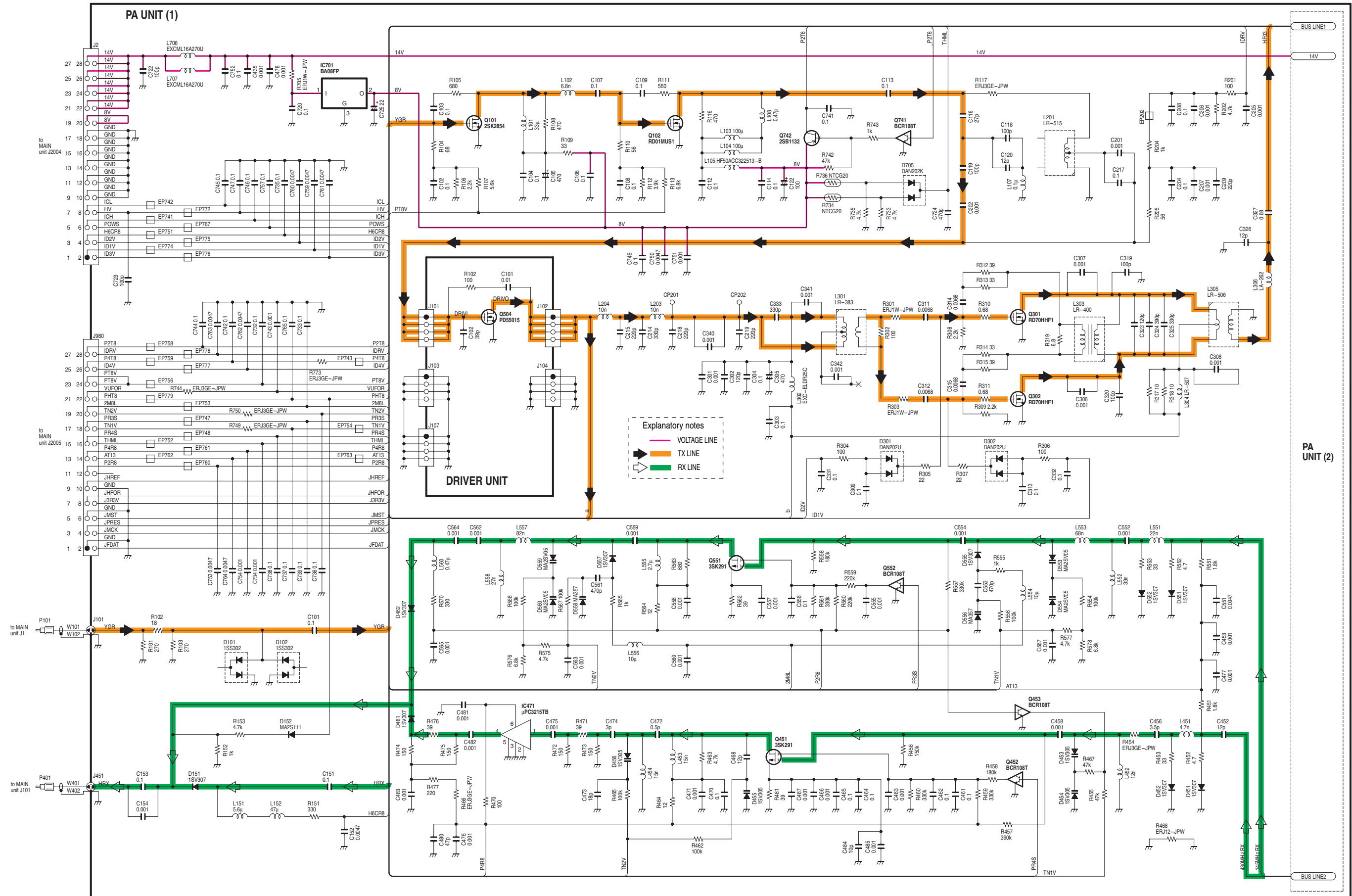

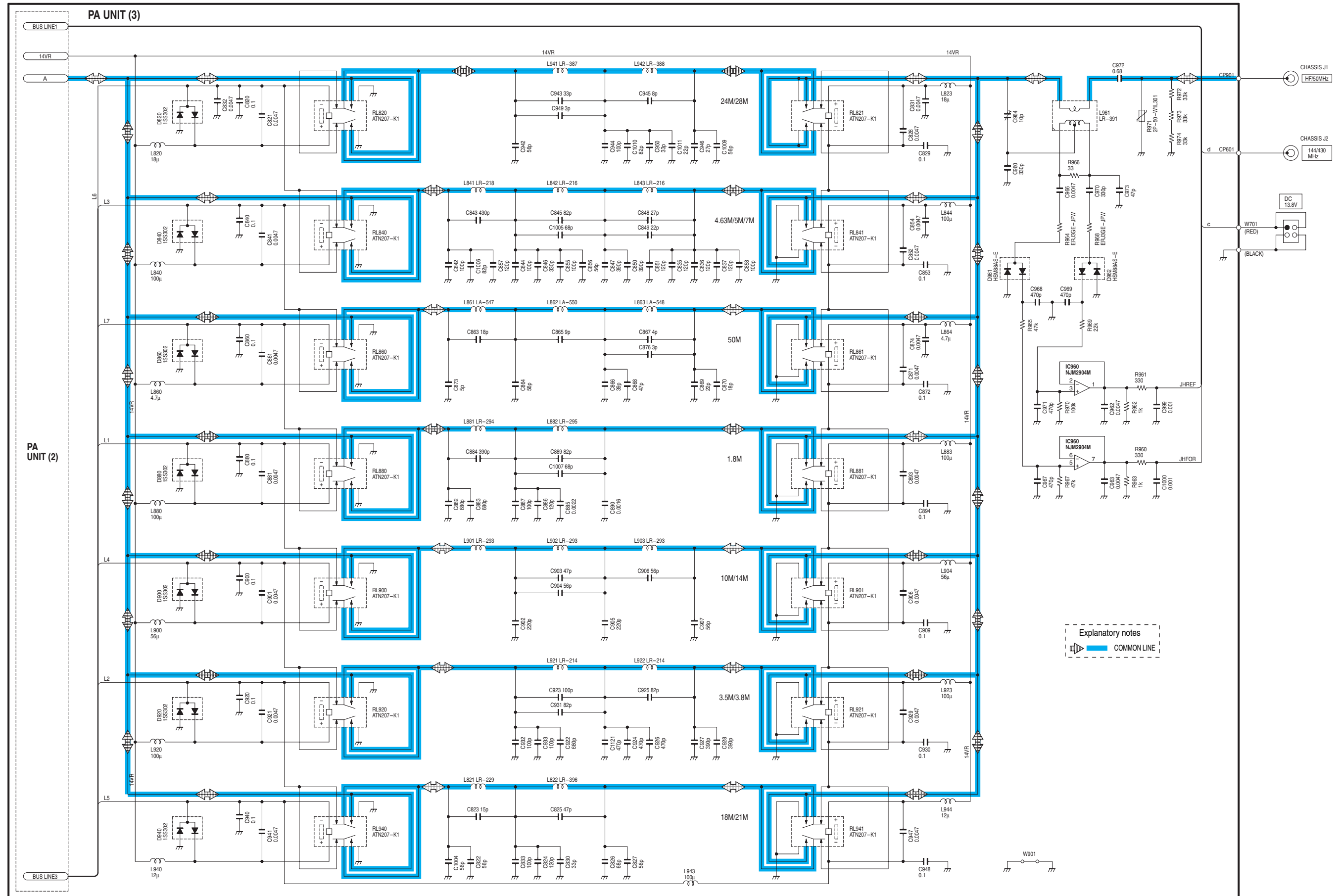

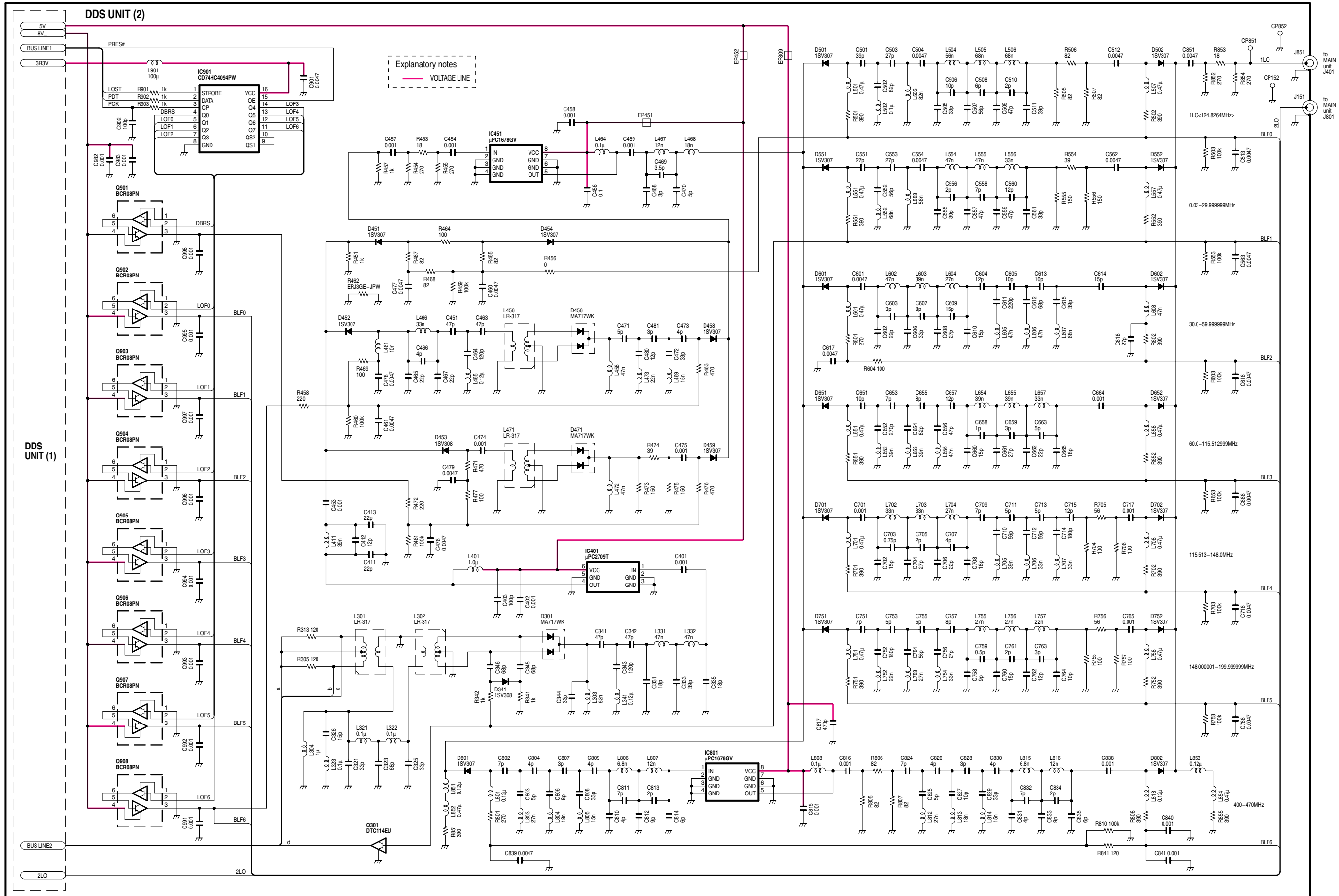

Icom Inc.

1-1-32, Kamiminami, Hirano-ku, Osaka 547-0003, Japan
Phone : +81 (06) 6793 5302
Fax : +81 (06) 6793 0013
URL : <http://www.icom.co.jp/world/index.html>

Icom America Inc.

<Corporate Headquarters>
2380 116th Avenue N.E., Bellevue, WA 98004, U.S.A.
Phone : +1 (425) 454-8155 Fax : +1 (425) 454-1509
URL : <http://www.icomamerica.com>
E-mail : sales@icomamerica.com
<Customer Service>
Phone : +1 (425) 454-7619

Icom Canada

Glenwood Centre #150-6165
Highway 17 Delta, B.C., V4K 5B8, Canada
Phone : +1 (604) 952-4266 Fax : +1 (604) 952-0090
URL : <http://www.icomcanada.com>
E-mail : info@icomcanada.com

Icom (Australia) Pty. Ltd.

Unit 1 / 103 Garden Road, Clayton VIC 3168 Australia
Phone : +61 (03) 9549-7500 Fax : +61 (03) 9549-7505
URL : <http://www.icom.net.au>
E-mail : sales@icom.net.au

Icom New Zealand

146A Harris Road, East Tamaki,
Auckland, New Zealand
Phone : +64 (09) 274 4062 Fax : +64 (09) 274 4708
URL : <http://www.icom.co.nz>
E-mail : inquiries@icom.co.nz

Beijing Icom Ltd.

10C07, Long silver Mansion, No.88, Yong Ding
Road, Haidian District, Beijing, 100039, China
Phone : +86 (010) 5889 5391/5392/5393
Fax : +86 (010) 5889 5395
E-mail : bjicom@bjicom.com
URL : <http://www.bjicom.com>

Icom (Europe) GmbH

Communication Equipment
Auf der Krautweide 24
65812 Bad Soden am Taunus, Germany
Phone : +49 (6196) 76685-0 Fax : +49 (6196) 76685-50
URL : <http://www.icomeurope.com>
E-mail : info@icomeurope.com

Icom Spain S.L

Ctra. Rubi, No. 88 Bajos A 08174, Sant Cugat del Valles, Barcelona, Spain
Phone : +34 (93) 590 26 70 Fax : +34 (93) 589 04 46
URL : <http://www.icomspain.com>
E-mail : icom@icomspain.com

Icom (UK) Ltd.

Blacksole House, Altira Park, Herne Bay, Kent CT6 6GZ, UK
Phone : +44 (0) 1227 741741 Fax : +44 (0) 1227 741742
URL : <http://www.icomuk.co.uk>
E-mail : info@icomuk.co.uk

Icom France s.a.s.

Zac de la Plaine
1 Rue Brindejone des Moulinais BP 5804
31505 Toulouse Cedex, France
Phone : +33 (5) 61 36 03 03 Fax : +33 (5) 61 36 03 00
URL : <http://www.icom-france.com>
E-mail : icom@icom-france.com

Asia Icom Inc.

6F No.68, Sec. 1 Cheng-Teh Road, Taipei, Taiwan, R.O.C.
Phone : +886 (02) 2559 1899 Fax : +886 (02) 2559 1874
URL : <http://www.asia-icom.com>
E-mail : sales@asia-icom.com

Icom Polska

81-850 Sopot, ul. 3 Maja 54, Poland
Phone : +48 (58) 550 7135 Fax : +48 (58) 551 0484
E-mail : icompolska@icompolska.com.pl

Count on us!